



## Durham E-Theses

---

### *Iraqi Kurdistan : an analysis and assessment of the development and operation of the political system.*

Stansfield, Gareth R V.

#### How to cite:

---

Stansfield, Gareth R V. (2001) *Iraqi Kurdistan : an analysis and assessment of the development and operation of the political system.*, Durham theses, Durham University. Available at Durham E-Theses Online: <http://etheses.dur.ac.uk/1205/>

#### Use policy

---

The full-text may be used and/or reproduced, and given to third parties in any format or medium, without prior permission or charge, for personal research or study, educational, or not-for-profit purposes provided that:

- a full bibliographic reference is made to the original source
- a [link](#) is made to the metadata record in Durham E-Theses
- the full-text is not changed in any way

The full-text must not be sold in any format or medium without the formal permission of the copyright holders.

Please consult the [full Durham E-Theses policy](#) for further details.

**IRAQI KURDISTAN:  
AN ANALYSIS AND ASSESSMENT OF THE  
DEVELOPMENT AND OPERATION OF THE  
POLITICAL SYSTEM**

The copyright of this thesis rests with the author. No quotation from it should be published in any form, including Electronic and the Internet, without the author's prior written consent. All information derived from this thesis must be acknowledged appropriately.

**GARETH R V STANSFIELD  
COLLEGE OF ST HILD AND ST BEDE**

**THESIS SUBMITTED FOR THE DEGREE OF PHD**



**CENTRE FOR MIDDLE EASTERN AND ISLAMIC STUDIES  
UNIVERSITY OF DURHAM  
MAY 2001**

**19 SEP 2001**

**Dedicated to the memory of my Grandparents,  
Charles and Ivy Stallard**

**Gareth R V Stansfield**

**Iraqi Kurdistan: An Analysis and Assessment of the Development  
and Operation of the Political System**

**Submitted for the Degree of PhD, 2001**

**Abstract**

This thesis examines the development and mechanics of the political system of Iraqi Kurdistan (northern Iraq). Since 1991, a *de facto* state system has been in existence in this region, a situation exists which has few precedents and no present-day comparison. The political system of Iraqi Kurdistan is identified as possessing political parties, electoral procedures, a national assembly, and organs of governance and administration. To understand this political system, the structures, decision-making processes and political history of the major political parties are analysed.

Historically, the Kurds have never possessed a state. However, following the Gulf War of 1990-1991 and the withdrawal of the Government of Iraq (GOI) from Iraqi Kurdistan, an indigenous emergency administration was established by the Iraqi Kurdistan Front (IKF), followed by multi-party elections in 1992. The administrative vacuum forced the militia-style political parties into governing the territory. Such a task brought parties supposedly representing different strata of Kurdish society together in a volatile coalition resulting in an equal sharing of power. However, interfactional fighting in 1994 resulting in the Kurdish region being divided between the two most powerful political parties (the KDP and PUK), with the system being further complicated by a multitude of smaller political parties and groupings.

A theme which is developed throughout the thesis is that the successful peaceful political development of the Iraqi Kurdish region may be achieved by employing a variant of a consociational system of governance. It is argued that a major component of a peaceful political settlement has to include elite accommodation within the governmental structure which is acceptable to the geopolitical thinking of neighbouring states and influencing powers, as well as being able to administer the Iraqi Kurdish region in this difficult period for the whole of Iraq. A modified power-sharing system may possibly allow for such political development to take place, later allowing the KDP and PUK to once again unify the political system of Iraqi Kurdistan.



## **Acknowledgements**

First, I would like to express my gratitude to my supervisor, Professor Ewan Anderson, for his continued support throughout the last five years. I've had a great time working with him. Similarly, Ewan's assistant, Rosie Baillon, has been a constant source of support and advice through some very exciting, and occasionally difficult, times. I would also like to thank Sian Anderson for countless lunches and coffees, and Dr Liam Anderson for his advice and assistance on the ins and outs of political science theories. Professor Tim Niblock was originally responsible for pushing me into Iraqi Kurdistan in 1996, and I would like to thank him for supporting me at a time when my experience was limited. Other sources of support in Durham include Professors Douglas Davies and Anoushiravan Ehteshami, Dr Alan Pearson, Dr Khalil Rashidian, Dr Salwa Amber, Christian Barkei, Sahab Farwaneh, my MA group and the residential tutors of the College of St. Hild and St. Bede, and particularly Alexandra Luff. To all of them I am extremely grateful.

In Iraqi Kurdistan, I had the opportunity to work with a range of characters. There are many who I would like to single out, and many who I wouldn't. However, from the international staff of IKRP, Housam Latif taught me the ropes of working in an emergency environment and was in effect my older brother. Dr Edward Twiddy worked with me in 1998, and, with Ewan, Rosie and Housam, we went a considerable way in establishing the University of Durham as the pre-eminent research authority in Iraqi Kurdistan. Throughout 2000, I was in Iraqi Kurdistan with Dr Julian Mallinson and Saran Morris. Their endless ability to work under supreme pressures was an inspiration and I cannot remember a period I enjoyed as much. IKRP was, and is, an organization dominated by its local staff, but, due to the current political situation in the region, I cannot name their names. However, the local staff of the Durham University Research Team (1997-1998) and IKRP (1998-2001) remain amongst my closest friends and they were responsible for me developing my understanding of Kurds and Kurdistan.

Within the political parties, I was able to meet many politicians on a regular basis and would like to thank in particular (in alphabetical order) Sami Abdul Rahman, Sa'ad

Abdullah, Shalaw Ali Askari, Roj Bahjæt, Massoud Barzani, Nechervan Barzani, Mamoum Brifkani, Ibrahim Hassan, Franso Hariri, Khadr Jabari, Kamaran, Hackam Khadr Hama Jan, Sheelan Khanaqa, Mahdi Khoshnaw, Kamal Mufti, Nawshirwan Mustafa Amin, Falah Mustafa Bakr, Adil Nasir, Sa'adi Pira, Dr Shafeeq Qazzaz, Shwan Qliasani, Dr Latif Rashid, Kosrat Rasoul Ali, Dr Barham Saleh, Jalal Talabani, Mohammad Tawfiq, and Hoshyar Zebari. In Erbil particularly, Ibrahim Hassan assisted me at every step, as did Falah Mustafa before him, and Sami Abdul Rahman always found time to discuss my work. Within Suleimaniyah, Shwan Qliasani's family became my own, and he enabled me to meet whoever I wanted to and is responsible for me perhaps taking up a considerable amount of the time of the PUK throughout 1998-2000. Similarly, Sa'adi Pira and Kosrat Rasoul Ali were always extremely forthcoming and supportive. I would like to thank especially all of those who kindly agreed to discuss my thesis.

Within the international organizations working in Iraqi Kurdistan, I would like to pick out a few people as being responsible for ensuring my sanity over the years: Siddiq Ibrahim, Dr Isabel Hemming, Sibi Lawson, Edis, Dr Osman Rasoul, Dr Mustafa Rasoul, Brady Kershaw, Erik Tollefsen, Ken Gibbs, Henry Vagg, Mike & Steve, John Kilkenny and Max Gaylard. Certain academics have been a source of advice and assistance over the last three years and have enabled me to speak to wide audiences and benefit from their years of experience. Special thanks to Dr Phebe Marr, Prof Judith Yaphe, Dr Michiel Leezenberg, Prof Robert Olson, and Dr Andreas Wimmer. Within governmental circles I would like to thank Dr Alastair McPhail and Dr Liane Saunders of the British Embassy in Ankara for watching over my security.

Finally, and most importantly, I would like to thank my parents. It hasn't been an easy three years for them with me being in Iraqi Kurdistan, but they remained totally committed to what I was doing and never let their worries affect my actions.



# Table of Contents

Title Page	1
Abstract	3
Acknowledgments	4
Table of Contents	6
List of Tables	14
List of Figures	15
List of Appendices	17
Reference Lists	17
List of Acronyms	18
Notes	19
Declaration and Statement of Copyright	20
<b><u>CHAPTER ONE: INTRODUCTION</u></b>	<b>21</b>
<u>1.1 Statement of Hypothesis</u>	26
<u>1.2 Structure of Thesis</u>	27
<b><u>CHAPTER TWO: THEORY AND METHODOLOGY</u></b>	<b>31</b>
<u>2.1 Introduction</u>	31
2.1.1 Aims	33
<u>2.2 Theories of 'The State'</u>	33
2.2.1 Defining 'The State'	34
2.2.1.1 <i>The State in Theory</i>	35
2.2.1.2 <i>The State in Practice</i>	37
<u>2.3 The Development of the Political System</u>	39
2.3.1 The Insurgent State	40
2.3.2 Application to Iraqi Kurdistan	41
2.3.3 Conclusion	42
<u>2.4 Comparative Political Theories</u>	43
2.4.1 Aims	43
2.4.2 Methodological Framework	44
2.4.2.1 <i>State, Non-State, or De Facto State? The Study of the Political System</i>	44
2.4.2.2 <i>Comparative Political Theory</i>	45
2.4.2.2.1 <i>The Holistic Approach</i>	46
2.4.2.2.2 <i>The Behavioural Approach</i>	49

2.4.2.2.3	<i>The Neo-Institutional Approach</i>	50
2.4.2.2.4	<i>Conclusion</i>	50
2.4.2.3	<i>Application to Iraqi Kurdistan</i>	51
2.4.2.3.1	<i>First World Statist Theories for a Non-State?</i>	51
2.4.2.3.2	<i>The Comparative Aspect</i>	52
2.4.2.3.3	<i>Consociational Political Systems</i>	53
2.4.2.3.4	<i>Conclusion</i>	56
2.5	<u>Field Methodology</u>	57
2.5.1	Pilot Study	58
2.5.2	Political Parties	59
2.5.3	Kurdistan Regional Government	60
2.5.4	Analytical Procedures	61
 <b><u>CHAPTER THREE: CONTEXTUAL ANALYSIS</u></b>		<b>63</b>
3.1	<u>Introduction</u>	63
3.1.1	Aims and Structure	63
3.2	<u>Geographical Context</u>	64
3.2.1	Introduction	64
3.2.1.1	<i>Defining Kurdistan</i>	65
3.2.1.2	<i>Defining Iraqi Kurdistan</i>	65
3.2.2	Physical Geography of Iraqi Kurdistan	67
3.2.2.1	<i>Topography</i>	67
3.2.2.2	<i>Climate</i>	70
3.2.2.3	<i>Rivers, Oil and Natural Resources</i>	71
3.2.2.3.1	<i>River Systems</i>	71
3.2.2.3.2	<i>Petroleum Resources</i>	73
3.2.2.4	<i>Conclusion</i>	73
3.2.3	Human Geography	74
3.2.3.1	<i>Population Geography</i>	74
3.2.3.1.1	<i>Population Distribution</i>	76
3.2.3.2	<i>Administrative Divisions</i>	77
3.2.3.2.1	<i>The Administrative Sub-Divisions</i>	80
3.2.4	Conclusion	82
3.3	<u>Language</u>	83
3.3.1	The Kurdish Dialects	84
3.3.1.1	<i>Lexical Systems</i>	85
3.3.2	Iraqi Kurdish Dialects	85
3.3.2.1	<i>Sorani and Bahdinani</i>	86
3.3.3	Conclusion	87

<b>3.4</b>	<b>Religion and Minorities</b>	<b>87</b>
3.4.1	Kurdish Religious Minorities	88
3.4.2	Non-Kurdish Minorities	89
<b>3.5</b>	<b>The Economic Structures of Iraqi Kurdistan</b>	<b>90</b>
3.5.1	Introduction	90
3.5.1.1	<i>The Traditional Agrarian Mode of Production</i>	93
3.5.1.2	<i>Oil and the Agrarian Economy</i>	93
3.5.2	The Economy Before the Algiers Agreement of 1975	94
3.5.2.1	<i>The Agricultural Sector</i>	94
3.5.2.2	<i>The Oil Sector</i>	96
3.5.2.3	<i>Manufacturing Industry</i>	96
3.5.2.4	<i>The Public Sector</i>	97
3.5.2.5	<i>Conclusion</i>	98
3.5.3	The Economy During the 1970s and 1980s	98
3.5.3.1	<i>The Algiers Agreement</i>	99
3.5.3.2	<i>The Iran-Iraq War and the Anfal Campaign</i>	100
3.5.3.3	<i>Conclusion</i>	102
3.5.4	The Economy in the 1990s	103
3.5.4.1	<i>The Sanctions Regime</i>	104
3.5.4.2	<i>The Impact of Sanctions on Iraq</i>	105
3.5.4.2.1	<i>Double Sanctions</i>	106
3.5.4.3	<i>Monetary Developments</i>	106
3.5.4.3.1	<i>The New Iraqi Dinar</i>	106
3.5.4.3.2	<i>The Kurdish Unit of Currency and Economic Controls</i>	107
3.5.4.4	<i>The Socio-Economic Situation, 1991-1996</i>	110
3.5.4.4.1	<i>The International Aid Effort</i>	110
3.5.4.4.2	<i>The Agricultural Sector</i>	111
3.5.4.4.3	<i>The Urban Economy</i>	113
3.5.4.5	<i>The Socio-Economic Situation, 1996-2000</i>	114
3.5.4.5.1	<i>UN Security Council Resolution 986</i>	114
3.5.4.5.2	<i>The Agricultural Sector</i>	117
3.5.4.5.3	<i>The Informal Sector</i>	119
3.5.5	Conclusion	120

**CHAPTER FOUR: THE DEVELOPMENT OF THE PARTY POLITICAL SYSTEM** **121**

<b>4.1</b>	<b>Introduction</b>	<b>121</b>
4.1.1	Aims	121
4.1.2	Methodology and Structure	121



<b>4.2</b>	<b><u>The Origins of the Party Political System</u></b>	<b>122</b>
4.2.1	The Kurdish Democratic Party	122
4.2.1.1	<i>The Role of Tribal Militancy</i>	123
4.2.1.1.1	<i>The Rebellion of Shiekh Mahmoud Barzinja</i>	125
4.2.1.1.2	<i>The 1943 Revolt of Barzani</i>	126
4.2.1.2	<i>The Rise of Nationalist Groups</i>	127
4.2.1.2.1	<i>The Republic of Mahabad</i>	127
4.2.1.2.2	<i>The Rise of Kurdish Nationalism in Iraq</i>	128
4.2.1.2.3	<i>Links Between the Iraqi Kurds and Mahabad</i>	130
4.2.1.2.4	<i>The Union of Nationalism and Tribalism</i>	131
4.2.1.3	<i>The Establishment of the Kurdish Democratic Party</i>	132
4.2.1.3.1	<i>The Balance of the Tribes and Urbanites</i>	132
4.2.1.3.2	<i>The KDP and the Collapse of Mahabad</i>	133
4.2.1.3.3	<i>The Kurdistan Democratic Party of Ibrahim Ahmed</i>	133
4.2.1.3.4	<i>The Emergence of New Cadres</i>	134
4.2.1.4	<i>Conclusion</i>	134
4.2.2	The Free Officers Coup	135
4.2.2.1	<i>The Return of Barzani</i>	135
4.2.2.2	<i>The Impact of the Agricultural Reforms of Kassem</i>	136
4.2.2.3	<i>The Road to Rebellion</i>	137
4.2.3	Conclusion	138
<b>4.3</b>	<b><u>The Development of the System: The Kurdish Revolution, 1961-1975</u></b>	<b>138</b>
4.3.1	The September 1961 Revolution	139
4.3.1.1	<i>Kassem's Offensive</i>	141
4.3.1.1.1	<i>The Formation of the Peshmerga</i>	141
4.3.1.1.2	<i>The Fall of Kassem</i>	143
4.3.2	The Kurds Divided	143
4.3.2.1	<i>Recommencement of Fighting</i>	144
4.3.2.2	<i>The KDP Divided and the Aggregation of Left-Wing Groupings</i>	145
4.3.2.3	<i>An Analysis of the Division</i>	146
4.3.3	The Kurds Under the Ba'ath	148
4.3.3.1	<i>Internecine Fighting</i>	148
4.3.3.2	<i>Ba'ath-Barzani Rapproachment</i>	149
4.3.4	The March Agreement and the Ashbatal	149
4.3.4.1	<i>The Golden Period</i>	150
4.3.4.2	<i>The Involvement of External Powers</i>	151
4.3.4.3	<i>The 1974 Autonomy Law</i>	152
4.3.4.4	<i>The Military Organization of the KDP</i>	153
4.3.4.5	<i>Algiers Agreement and the Ashbatal</i>	155

<b>4.4</b>	<b><u>The Patriotic Union of Kurdistan</u></b>	<b>156</b>
4.4.1	The Establishment of the PUK	157
4.4.1.1	<i>The Origins of the PUK</i>	158
4.4.1.1.1	<i>The 1964 Division</i>	159
4.4.1.1.2	<i>Influence of Maoist Doctrines</i>	160
4.4.1.2	<i>The Formation of the Komala</i>	161
4.4.1.2.1	<i>The Early Organizational Structure of the Komala</i>	162
4.4.1.2.2	<i>Ideological Divisions Within the Komala</i>	162
4.4.1.2.3	<i>The Komala and the Formation of the PUK</i>	163
4.4.1.2.4	<i>The Komala Leadership</i>	164
4.4.1.3	<i>The Formation of Bezutnawa</i>	165
4.4.1.4	<i>Operational Structure of the PUK</i>	166
4.4.1.5	<i>Conclusion</i>	168
<b>4.5</b>	<b><u>The KDP and PUK in the Aftermath of the Ashbatal</u></b>	<b>169</b>
4.5.1	The Power Struggle Within the KDP-PL	171
4.5.2	The Hakkari Massacre	172
4.5.2.1	<i>Chronology of Events</i>	172
4.5.2.2	<i>The Hakkari Massacre Analysed</i>	173
4.5.2.3	<i>The Impact on the Political System</i>	174
4.5.2.4	<i>The Aftermath of the Massacre</i>	175
4.5.3	The Iran-Iraq War and the <i>Anfal</i> Campaign	176
4.5.3.1	<i>The Iran-Iraq War</i>	178
4.5.3.1.1	<i>Unity and Division Within the PUK</i>	178
4.5.3.1.2	<i>The Collapse of PUK-GOI Negotiations</i>	180
4.5.4	The Formation of the Iraqi Kurdistan Front	181
4.5.5	Conclusion	182
 <b><u>CHAPTER FIVE: THE ORGANIZATIONAL STRUCTURE AND DECISION- MAKING PROCESSES OF THE KDP AND PUK</u></b>		<b>184</b>
<b>5.1</b>	<b><u>Introduction</u></b>	<b>184</b>
5.1.1	Aims	184
5.1.2	Structure	185
<b>5.2</b>	<b><u>Chronological Analysis of the 1990s</u></b>	<b>185</b>
5.2.1	The Second Gulf War and the <i>Rapareen</i>	186
5.2.2	The <i>De Facto</i> State	188
5.2.3	The Conflict of 1994	189
5.2.3.1	<i>The Involvement of the IMK</i>	189
5.2.3.2	<i>KDP-PUK Conflict</i>	190
5.2.4	The Invasion of Erbil, 1996	191

5.2.4.1	<i>Operation Vengeance Storm, 1997</i>	192
5.2.4.2	<i>Conclusion</i>	193
5.2.5	The Washington Agreement of 1998	194
5.2.5.1	<i>The Shaqlawa-Koysinjaq Meetings</i>	194
5.2.5.2	<i>The Washington Agreement</i>	195
5.2.6	Conclusion	198
<b>5.3</b>	<b><u>The KDP and PUK</u></b>	<b>200</b>
5.3.1	Introduction	200
5.3.1.1	<i>Structure</i>	200
5.3.2	The KDP	201
5.3.2.1	<i>The Morphology of the KDP</i>	201
5.4.2.1.1	<i>KDP Leadership Morphology</i>	201
5.4.2.1.2	<i>Regional and Sub-Regional Structures</i>	204
5.4.2.1.3	<i>Conclusion</i>	206
5.3.2.2	<i>The Decision-Making Process of the KDP</i>	206
5.3.2.2.1	<i>The Prescribed Decision-Making Process</i>	207
5.3.2.2.2	<i>Criticisms of the KDP Decision-Making Process</i>	208
5.3.2.3	<i>Analysis and Assessment of the KDP Leadership Structure</i>	211
5.3.2.3.1	<i>Power Groupings</i>	212
5.3.2.3.2	<i>Conclusion</i>	214
5.3.3	The PUK	214
5.3.3.1	<i>The Morphology of the PUK</i>	215
5.3.3.1.1	<i>PUK Leadership Morphology</i>	215
5.3.3.1.2	<i>Regional and Sub-Regional Structures</i>	217
5.3.3.1.3	<i>Conclusion</i>	218
5.3.3.2	<i>The Decision-Making Process of the PUK</i>	218
5.3.3.2.1	<i>The Prescribed Decision-Making Process</i>	218
5.3.3.2.2	<i>Criticisms of the PUK Decision-Making Process</i>	221
5.3.3.3	<i>Assessment and Analysis of the PUK Leadership Structure</i>	222
5.3.3.3.1	<i>Power Groupings</i>	223
5.3.3.3.2	<i>Conclusion</i>	226
5.3.4	Conclusion	227
<b>CHAPTER SIX:</b>	<b><u>THE ORGANIZATIONAL STRUCTURE OF THE</u></b>	<b>229</b>
	<b><u>KURDISTAN REGIONAL GOVERNMENT</u></b>	
<b>6.1</b>	<b><u>Introduction</u></b>	<b>229</b>
6.1.1	Aims	230
6.1.2	Structure	231



<b>6.2</b>	<b><u>The Aftermath of the Rapareen</u></b>	<b>231</b>
6.2.1	Emergency Government	232
6.2.2	The Establishment of Legal Provisions for Governance Formation	234
6.2.2.1	<i>Law No. 1: The Law of the Iraqi Kurdistan National Assembly</i>	236
6.2.2.2	<i>Law No. 2: The Leader of the Kurdistan Liberation Movement</i>	237
6.2.2.3	<i>The Laws of the IKF as De Facto Constitution?</i>	239
6.2.3	The Elections	241
6.2.3.1	<i>Analysis of Results</i>	241
6.2.3.1.1	<i>The KNA Results</i>	241
6.2.3.1.2	<i>The Leadership Results</i>	243
6.2.4	Conclusion	244
<b>6.3</b>	<b><u>The Morphology and Prescribed Operating Procedures of the Kurdistan National Assembly</u></b>	<b>244</b>
6.3.1	The Morphology of the KNA	244
6.3.1.1	<i>Principles and Procedures</i>	246
6.3.1.2	<i>Offices and MPs</i>	247
6.3.1.3	<i>Committees of the Assembly</i>	247
6.3.2	The Legislative Process	248
6.3.2.1	<i>The Passing of Laws</i>	249
6.3.2.1.1	<i>Parliamentary Questions</i>	250
6.3.3	Conclusion	251
<b>6.4</b>	<b><u>The Morphology and Prescribed Operating Procedures of the Kurdistan Regional Government</u></b>	<b>251</b>
6.4.1	The Morphology and Prescribed Planning Process of the Regional Executive	252
6.4.1.1	<i>Cabinet Composition</i>	252
6.4.1.2	<i>Cabinet Procedures</i>	253
6.4.2	The Executive Offices of the Governorate	255
6.4.2.1	<i>Principles and Procedures of the Governorate Executive Process</i>	256
6.4.3	Conclusion	257
<b>6.5</b>	<b><u>The Judicial System</u></b>	<b>258</b>
6.5.1	Principles and Procedures	259
6.5.2	The Organization of the Judiciary	259
6.5.3	Conclusion	261
<b>6.6</b>	<b><u>Conclusion</u></b>	<b>261</b>

<b><u>CHAPTER SEVEN: THE KURDISTAN REGIONAL GOVERNMENT</u></b>	<b>263</b>
<b><u>1992-2000</u></b>	
<b><u>7.1 Introduction</u></b>	<b>263</b>
<b><u>7.2 The Kurdistan Regional Government, 1992-1996</u></b>	<b>264</b>
7.2.1 The Power Sharing System of the First and Second Cabinets	264
7.2.1.1 <i>The Establishment of the 50-50 System</i>	264
7.2.1.2 <i>The Aim of the 50-50 System</i>	265
7.2.2 The First Cabinet of the KRG	266
7.2.2.1 <i>Ministries and Deputies</i>	266
7.2.3 The Second Cabinet of the KRG	269
7.2.3.1 <i>The Formation of the Second Cabinet</i>	270
7.2.3.2 <i>Analysis of the Second Cabinet</i>	270
7.2.4 The Polarization of the Political System	272
7.2.4.1 <i>The Changing Position of the Smaller Parties</i>	272
7.2.4.2 <i>Party Amalgamations</i>	273
7.2.5 Conclusion	275
<b><u>7.3 Divided Government and the Establishment of the Third Cabinets</u></b>	<b>276</b>
7.3.1 The Division of Iraqi Kurdistan	277
7.3.2 The Establishment of the Post-1996 Political System	278
7.3.2.1 <i>The Formation of the Third Cabinets</i>	279
7.3.2.2 <i>The Divided Political System</i>	280
7.3.3 Conclusion	282
<b><u>7.4 The Third Cabinets of the KRG</u></b>	<b>282</b>
7.4.1 The KRG (Erbil)	283
7.4.1.1 <i>General Morphology and Prescribed Mechanisms of the Political System</i>	283
7.4.1.2 <i>Cabinet Composition</i>	283
7.4.1.3 <i>The KDP and KRG Relationship</i>	284
7.4.1.3.1 <i>The Position of Massoud Barzani and the Political Bureau</i>	285
7.4.2 The KRG (Suleimaniyah)	288
7.4.2.1 <i>General Morphology and Prescribed Mechanisms of the Political System</i>	289
7.4.2.2 <i>Cabinet Composition</i>	289
7.4.2.3 <i>The PUK and KRG Relationship</i>	291
7.4.2.3.1 <i>The Position of Jalal Talabani and the Political Bureau</i>	292
7.4.3 Conclusion	294



<b><u>7.5</u></b>	<b><u>Analysis of the Decision-Making Process of the Third Cabinets</u></b>	<b>296</b>
7.5.1	Framework of Analysis	296
7.5.2	Analysis of the Kurdistan Regional Governments	297
7.5.2.1	<i>The Initial Planning Process</i>	297
7.5.2.2	<i>Budgetary Planning</i>	302
7.5.2.3	<i>The Implementation Process</i>	305
7.5.3	Conclusion	308
<b><u>7.6</u></b>	<b><u>Conclusion</u></b>	<b>309</b>
<b><u>CHAPTER EIGHT: CONCLUSION</u></b>		<b>312</b>

### **List of Tables**

Table 3.1	<i>Hydro-electric / Irrigation schemes in Iraqi Kurdistan</i>	72
Table 3.2	<i>Estimates of the Kurdish Population</i>	75
Table 3.3	<i>Population Estimates, By Governorate</i>	76
Table 3.4	<i>Rural – Urban Population Breakdown, All Governorates</i>	77
Table 3.5	<i>Production of Wheat and Barley in 1980</i>	95
Table 3.6	<i>Revenue Generated at Ibrahim Khalil (PUK estimates)</i>	109
Table 3.7	<i>Resources Channelled Through UN Agencies in Iraq, 1991-1996</i>	112
Table 3.8	<i>SCR 986 Series Revenue</i>	116
Table 3.9	<i>Total area Under Wheat in Donums for 1994-97</i>	118
Table 6.1	<i>The Electoral Steering Committee of 1991-1992</i>	235
Table 6.2	<i>The Competing Parties of the May 1992 Elections</i>	242
Table 6.3	<i>The Electoral Regions of the 1992 Election</i>	243
Table 6.4	<i>Votes and Percentages for the Leadership Election</i>	243
Table 6.5	<i>Ministry Establishing Laws of the KNA</i>	253
Table 7.1	<i>The First Cabinet of the Kurdistan Regional Government</i>	267
Table 7.2	<i>The Second Cabinet of the Kurdistan Regional Government</i>	271
Table 7.3	<i>The Third Cabinet (Erbil) of the KRG</i>	285

Table 7.4	<i>The Third Cabinet (Suleimaniyah) 1998</i>	291
Table A1:1	<i>Rural Population Figures: Erbil Governorate</i>	317
Table A1:2	<i>Rural Population Figures: Dohuk Governorate</i>	318
Table A1:3	<i>Rural Population Figures: Suleimaniyah Governorate</i>	319
Table A1:4	<i>Rural Population Figures: Darbandikhan Governorate</i>	320
Table A1:5	<i>Collective Settlement Population Figures: Erbil Governorate</i>	320
Table A1:6	<i>Collective Settlement Population Figures: Dohuk Governorate</i>	321
Table A1:7	<i>Collective Settlement Population Figures: Suleimaniyah Governorate</i>	323
Table A1:8	<i>Collective Settlement Population Figures: Darbandikhan Governorate</i>	324
Table A3:1	<i>The Central Committee of the KDP (Eleventh Congress)</i>	333
Table A3:2	<i>The Central Committee of the KDP (Twelfth Congress)</i>	334
Table A3:3	<i>The Leadership Office of the PUK – 1999</i>	335
Table A4:1	<i>The Results of the 1992 Elections – KDP Figures</i>	336
Table A4:2	<i>Christian Minority Lists (KDP figures)</i>	336
Table A4:3	<i>Redistribution of Votes to KDP and PUK Lists (KDP)</i>	337
Table A4:4	<i>The Results of the 1992 Elections - PUK Figures</i>	337
Table A4:5	<i>Redistribution of Votes to KDP and PUK Lists (PUK)</i>	337
Table A4:6	<i>List of KNA Representatives</i>	338

## **List of Figures**

Figure 2.1	<i>Schematic Representation of State Characteristics</i>	38
Figure 3.1	<i>Depiction of the Kurdish Region</i>	66
Figure 3.2	<i>Kurdish Representation of Iraqi Kurdistan</i>	68
Figure 3.3	<i>Kurdish Controlled Iraqi Kurdistan, 1991-2001</i>	69
Figure 3.4	<i>Administrative Sub-Divisions, 1999</i>	79
Figure 3.5	<i>The Governorates, Qaza, and Nahiya of Iraqi Kurdistan</i>	81
Figure 4.1	<i>The Origins of the Kurdistan Democratic Party – Iraq</i>	124

Figure 4.2	<i>The Kurdish Revolt, 1961-1975</i>	140
Figure 4.3	<i>Organizational Structure of KDP During the 1975 Revolution</i>	154
Figure 4.4	<i>Constituent Groupings of the PUK</i>	159
Figure 4.5	<i>The Hierarchy of Komala and Bezutnawa</i>	167
Figure 4.6	<i>Chronology of Events, 1975-1990</i>	170
Figure 5.1	<i>The Leadership Structure of the KDP</i>	203
Figure 5.2	<i>KDP Morphology, Regional Organization</i>	205
Figure 5.3	<i>The Leadership Structure of the PUK</i>	216
Figure 5.4	<i>The Divisions of the PUK, 1975-1999</i>	223
Figure 6.1	<i>Kurdistan National Assembly Morphology</i>	245
Figure 6.2	<i>The Formation of Committees of the Assembly</i>	248
Figure 6.3	<i>Representation of the Proposal of Laws and Regulations</i>	249
Figure 6.4	<i>Questioning and Answering in the KNA</i>	250
Figure 6.5	<i>Morphology of the Cabinet</i>	254
Figure 6.6	<i>Morphology of the Judiciary</i>	260
Figure 7.1	<i>Divided Government: Constituent Parts of the Political System of Iraqi Kurdistan, 1996</i>	281
Figure 7.2	<i>The Constituent Parts of the Political System of Erbil-Dohuk</i>	284
Figure 7.3	<i>The Constituent Parts of the Political System of Suleimaniyah</i>	290
Figure 7.4	<i>Schematic Representation of the Initial Planning Process of the KRGs</i>	301
Figure 7.5	<i>Schematic Representation of the Budgetary Planning of the KRGs</i>	304
Figure 7.6	<i>The Implementation Process of the KRGs</i>	307
Figure A5:1	<i>Ministry of Municipalities and Tourism</i>	341
Figure A5:2	<i>Ministry of Agriculture and Irrigation</i>	342
Figure A5:3	<i>Ministry of Islamic Affairs</i>	343
Figure A5:4	<i>Ministry of Culture</i>	344



Figure A5:5	<i>Ministry of Education</i>	345
Figure A5:6	<i>Ministry of Finance and Economic Affairs</i>	346
Figure A5:7	<i>Ministry of Humanitarian Affairs and Cooperation</i>	347
Figure A5:8	<i>Ministry of the Interior</i>	348
Figure A5:9	<i>Ministry of Justice</i>	349
Figure A5:10	<i>Ministry of Peshmerga Affairs (Defence)</i>	350
Figure A5:11	<i>Ministry of Industry and Power</i>	351
Figure A5:12	<i>Ministry of Reconstruction and Development</i>	352
Figure A5:13	<i>Ministry of Public Works and Housing</i>	353
Figure A5:14	<i>Ministry of Transportation and Communication</i>	354

## **Appendices**

Appendix 1	<i>Population Statistics</i>	317
Appendix 2	<i>Agreements Between Parties</i>	325
Appendix 3	<i>Party Lists</i>	333
Appendix 4	<i>Election Results and KNA List</i>	336
Appendix 5	<i>Ministry Organograms</i>	340
Appendix 6	<i>Selected Ministry Records</i>	355

## **Reference Lists**

Reference List 1	<i>Books, Articles, Theses</i>	369
Reference List 2	<i>Interviews, Meetings and Correspondence</i>	403
Reference List 3	<i>Summaries of World Broadcasts</i>	415

## List of Acronyms

ADM	Assyrian Democratic Movement	MAI	Ministry of Agriculture and Irrigation
CIA	Central Intelligence Agency	MHSA	Ministry of Health and Social Affairs
DC	Democratic Christians	MIT	Turkish Military Intelligence
DFID	Department for International Development	MMT	Ministry of Municipalities and Tourism
DURT	Durham University Research Team	MOU	Memorandum of Understanding
ECHO	European Community Humanitarian Organisation	MP	Member of Parliament
FAO	Food and Agriculture Organisation	MRD	Ministry of Reconstruction and Development
GAP	South-East Anatolia Project	NATO	North Atlantic Treaty Organization
GDP	Gross Domestic Product	NCRC	National Council of Revolutionary Command
IAEA	International Atomic Energy Authority	NGO	Non-Governmental Organization
ICP	Iraqi Communist Party	NID	New Iraqi Dinar
IDP	Internally Displaced People	ODA	Overseas Development Administration
IKF	Iraqi Kurdistan Front	OID	Old Iraqi Dinar
IKRP	Iraqi Kurdistan Research Programme	OPEC	Organization of Petroleum Exporting Countries
ILP	Independent Labour Party	PASOK	Kurdish Socialist Party
IMK	Islamic Movement of Kurdistan	PKK	Kurdistan Worker's Party
IR	International Relations (theory)	PUK	Patriotic Union of Kurdistan
KAD	Kaldo Ashur Democrat (Party)	SAVAK	Iranian Intelligence Service
KCP	Kurdistan Communist Party	SCR	Security Council Resolution
KCU	Kurdistan Christian Union	SIS	UK Secret Intelligence Service
KDP	Kurdistan Democratic Party	SWB	Summary of World Broadcasts (BBC)
KDP-I	Kurdistan Democratic Party – Iran	UK	United Kingdom
KDP-PC	Kurdistan Democratic Party – Provisional Committee	UN	United Nations
KDP-PL	Kurdistan Democratic Party – Provisional Leadership	UNDHA	United Nations Department for
KIU	Kurdistan Islamic Union		



## Humanitarian Affairs

KNA	Kurdistan National Assembly	UNHCR	United Nations High Commission for Refugees
KPDP	Kurdistan Popular Democratic Party	UNICEF	United Nations Children's Fund
KRG	Kurdistan Regional Government	UNOHCI	United Nations Office of the Humanitarian Coordinator of Iraq
KSDP	Kurdistan Socialist Democratic Party	UPK	Unity Party of Kurdistan
KSP	Kurdistan Socialist Party	US	United States
KTP	Kurdistan Toilers' Party	USSR	Union of Soviet Socialist Republics
MAG	Mines Advisory Group	WFP	World Food Programme

## Notes

In the course of researching this thesis, I have had the privilege of working with the political parties of Iraqi Kurdistan, and a range of political characters. As Iraqi Kurdish politics is dominated by the presence of these characters, I have referred to them often in the text. As such, it is necessary to provide a brief note as to how they are referred to. I have chosen, wherever possible, to refer to characters by the name which they are commonly referred to in the region. Many are referred to by their first names, for example Sami (Sami Abdel Rahman) and Nawshirwan (Nawshirwan Mustafa Amin) and I have similarly chosen to do the same. For members of the Barzani family, to assist in clarity, Mulla Mustafa Barzani is referred to as 'Barzani', with the current leader and other Barzanis being referred to by their first names, again a common practice in Iraqi Kurdistan (for example, 'Massoud', 'Nechervan'). With regard to Jalal Talabani, for reasons of clarity, I refer to him throughout the text as 'Talabani'.

## Declaration

I confirm that no part of the material offered has previously been submitted by me for a degree in this or any other University. If material has been generated through joint work, my independent contribution has been clearly indicated. In all other cases material from the work of others has been acknowledged and quotations and paraphrases suitably indicated.

Signed: *Gareth Graustier*

Date: *1/1/01*

## Statement of Copyright

“The copyright of this thesis rests with the author. No quotation from it should be published without their prior written consent and information derived from it should be acknowledged.”

# Chapter 1

## Introduction

Iraqi Kurdistan is at a momentous crossroads in terms of its political development. At the time of writing, political parties of Iraqi Kurdistan have governed and administered the region under their territorial control since 1991 when the administration and military forces of the Government of Iraq (GOI) withdrew from the north of the country. The intervening decade has not been an easy period for the Iraqi Kurdish *de facto* state and its people. For the first five years of the 1990s, the political system of the region exhibited widespread instability, with internecine fighting being common, and the involvement of foreign national governments in the affairs of the fledgling *de facto* state seemingly being a constant feature of political life.

Fundamentally affecting the Kurdish political system in Iraq, United Nations (UN) imposed sanctions against Iraq resulted in widespread hardships for the Iraqi people as a whole, yet, conversely, gave Iraqi Kurdistan a modicum of security against the GOI with the presence of international observers and a separated political and economic system. The benefits of the sanctions regime were further enhanced in 1996 with Security Council Resolution (SCR) 986 allowing significant amounts of oil to be sold by Iraq in order to purchase humanitarian supplies. 13 percent of the revenues were guaranteed for the northern governorates under Kurdish control, administered by the agencies of the UN, with the assistance of the Kurdish local authorities.

The political system of Iraqi Kurdistan has therefore developed under conditions which may be considered anomalous, both for the Kurds and for Iraq. Faced with the necessity of having to form an administration in the aftermath of the withdrawal of Kurdish forces, the political parties of the region struggled to come to terms with their new found territorial authority. The problems were enhanced further by imperious neighbouring powers promoting tensions within the *de facto* state for their own domestic reasons.



Such instability and problems has led academics, journalists and politicians alike to denigrate the attempts of the Kurdish political leaders to establish a government charged with regulating the domestic affairs of Iraqi Kurdistan and promoting security with the establishment of a civil society. The government of Turkey in particular has referred to the Iraqi Kurdish region as being a power vacuum with no effective government and therefore characterised by lawlessness. Bulent Ecevit, the Prime Minister of Turkey, referred to the existence of an “*authority vacuum*” as a member of the opposition in 1996.<sup>1</sup> His views have not changed since and, as Prime Minister in 1999, he referred to a “*lack of authority in northern Iraq*”.<sup>2</sup> The President of Turkey, Suleiman Demirel, noted that “*the territory of northern Iraq is a political vacuum: there is no government,*” clearly supporting the position of his Prime Minister.<sup>3</sup>

Prominent academics also mirror these criticisms. When analysing Iraq since 1990, and particularly with relation to the continued survival of the regime of Saddam Hussein, Perthes forwards that “*the Kurdish parties . . . . have not been able to put in place even the slightest element of any structure designed to create a better, democratic Iraq in the northern part of the country.*”<sup>4</sup> Gunter, currently one of the most prolific writers on Iraqi Kurdish politics, is a regular exponent of the argument of the “*power vacuum*”. The power vacuum scenario is one of political instability creating a vacuum of power into which neighbouring states and the United States (US) have been drawn.<sup>5</sup> It is a problematic concept to deal with, both in terms of semantics and actualities in Iraqi Kurdistan itself. Indeed, the term is often banded around as a joke between different Kurdish politicians, with the claim that there is not a lack of power in the region, instead there are too many groupings exercising it. Sa’adi Pira, the prominent Patriotic Union of Kurdistan (PUK) politician, suggested that Iraqi Kurdistan could not be identified as a power vacuum as the activities of the Kurdistan Regional Government (KRG), particularly since 1996, have become progressively institutionalised within the territory. A term he identified as being more

---

<sup>1</sup> Republic of Turkey, Regional Security Plan, 15 April 1996.

<sup>2</sup> *Ibid.*, 27 January 1999.

<sup>3</sup> Quoted in Gunter (1999a) “Developments in Iraqi Kurdistan: Their Influence on Neighbouring States and the Kurdish Movements in Surrounding States”, in *Irakisch-Kurdistan: Status und Perspektiven. Ergebnisse einer internationalen tagung 1999 in Berlin*, pp. 65-80. Berlin: Awadani e.V.: p. 80.

<sup>4</sup> Perthes (1998) *Iraq Under Sanctions: A Regime Defiant*. Middle East Programme Briefing No. 40 (February). London: Chatham House, p. 1.

<sup>5</sup> Gunter (1999a) *op. cit.*, pp. 66-68, for example.

appropriate was a 'defence vacuum', as the KRG and the political parties do not have the means to prevent foreign incursions, either by political or military means.<sup>6</sup>

Within Erbil, the Deputy Prime Minister of the fourth cabinet of the KRG, Sami Abdul Rahman, similarly disagreed with the concept of the power vacuum, suggesting that the city of Erbil was one that enjoyed high standards of law and order. He further identified the international context of the power vacuum, which was apparent at the time due to the military forces of Turkey attacking Kurdish Workers' Party (PKK) bases in Iraqi Kurdistan. These incursions have often been cited as evidence of the Kurdistan Democratic Party's (KDP) lack of control of borders. However, Sami argued that the incursions of the military forces of the government of Turkey were, in effect, joint operations between KDP *peshmerga* (militia) and Turkish forces against the PKK, stating that no foreign national government military activity occurs in Iraqi Kurdistan without the permission of the KDP, within its own territory.<sup>7</sup> In a domestic sense, Nawshirwan Mustafa Amin, the unofficial deputy-leader of the PUK, claimed that the streets of Suleimaniyah are safer than those of Diyarbekir in Turkey, again dispelling the concept of the power vacuum.<sup>8</sup>

However, this ability to administer adequately the domestic affairs of Iraqi Kurdistan has still not been accepted by the majority of commentators. Pelletiere, writing in 1991, even argued that the supposed aggressive nature of the Kurds pre-empts the ability of them to self-govern an independent Kurdish entity, describing such a situation as "*patently unworkable*" and that:

*"... such an entity would have to be administered by Kurds, which is an impossibility. The very qualities that have enabled the Kurds to survive for centuries make it virtually certain that they cannot rule themselves. The Kurds, as a group, are ungovernable, even by leaders they themselves have chosen. Thus all of this current agitation for Kurdish "statehood" must be seen to be misguided."*<sup>9</sup>

The continuing existence of an independent Kurdish entity for the last decade has gone a considerable way to disproving Pelletiere's claims and academic and

---

<sup>6</sup> Interview with Sa'adi Pira, Suleimaniyah, 9 June 1998.

<sup>7</sup> Interview with Sami Abdul Rahman, Salahadin, 8 September 1999.

<sup>8</sup> Interview with Nawshirwan Mustafa, Suleimaniyah, 29 June 1999.

<sup>9</sup> Pelletiere, 1991, *The Kurds and their Agas: An Assessment of the Situation in Northern Iraq*. September 1991, Philadelphia: Strategic Studies Institute, US Army War College, p. 1.



journalistic articles have started to hint at the good as well as the bad aspects of the *de facto* administration.<sup>10</sup> An important indicator of this change may be seen in the letters sent by various United States (US) politicians to the PUK, congratulating the party on its twenty-fifth anniversary.<sup>11</sup> Congressman Filner stated in his letter that “*I feel strongly that the United States must support and protect the democratic institutions that are emerging in Iraqi Kurdistan.*”<sup>12</sup> Similarly, Senator Richard G Lugar noted that the “*fledgling democratic institutions must be protected from the tyranny of the Iraqi regime.*”<sup>13</sup> Perhaps even more complementary are the words of Senator J Robert Kerrey. In his letter, again to the PUK, he stated that:

*“There are some who say that democracy is an alien concept to Iraqis. But the democratic civil society which is being built in Iraqi Kurdistan shows that Iraqis, like all people, have both the desire and the talent to govern themselves.”*<sup>14</sup>

However, opinions at the end of the decade remained, on the whole, negative due to the animosity which exists between the KDP and PUK. For example, Natali commenced her 1999 analysis of the Kurdish issue in Iraq after the Gulf War by stating that the internal conflict between the KDP and PUK in 1994 dissipated the KRG.<sup>15</sup> In a similar vein, Sheikmous identified this conflict as weakening and undermining the indigenous Kurdish administration.<sup>16</sup>

It is undeniable that conflict in 1994 and 1996 resulted in the division of the administration into two separate entities based in Erbil and Suleimaniyah, dominated by the KDP and PUK respectively. However, rather than viewing it as a ‘dissipation’ or ‘weakening’ caused maybe by the ungovernable nature of the Kurdish people, it is perhaps more correct to see it as a function of the level of maturity of the Iraqi

---

<sup>10</sup> For examples of such articles, see Prince (1993) “A Kurdish State in Iraq?” *Current History*, Vol. 92, No. 570, pp. 17-22; Lawrence (2000) “Iraqi Kurds Enjoy a De Facto State,” *Christian Science Monitor*, 3 May 2000; Stansfield (2000a) “Iraq: Kurdish Divisions” *Oxford Analytica Daily Brief*, 14 April, V, pp. 14-16.

<sup>11</sup> The twenty-fifth anniversary of the PUK was on 1 June 2000. Celebrations were held in the PUK political bureau complex at Kalarcholan, at which I attended.

<sup>12</sup> Letter from Congressman Bob Filner to Dr Barham Salih, PUK Representative to Washington DC, 26 May 2000.

<sup>13</sup> Letter from Senator Richard G Lugar to Dr Barham Salih, PUK Representative to Washington DC, 30 May 2000.

<sup>14</sup> Letter from Senator J Robert Kerrey to Jalal Talabani, Secretary General of the PUK, 2 June 2000.

<sup>15</sup> Natali (1999) *International Aid, Regional Politics and the Kurdish Issue in Iraq After the Gulf War*. Emirates Center for Strategic Studies and Research, p.1, p. 27.

Kurdish political system and parties. It could be argued that the weakness in the political system stems from the rivalry which exists, for whatever reasons, between the KDP, PUK, and other parties. At the current stage of development, neither party has the ability to manage these rivalries in a peaceful manner and resort to the military option, often with the assistance of foreign national governments, making any joint government an extremely unstable entity. To have them separated in a divided political system may, paradoxically, result in its strengthening by allowing the increased efficiency of the activities of the *de facto* governmental institutions. Furthermore, to have a unified administration presents a regional geopolitical instability, which neighbouring countries and interested powers will attempt to resolve with their own national interests in mind.<sup>17</sup>

Still, the dominant opinion continues to be one of describing the political parties of Iraqi Kurdistan, and particularly the KDP and PUK, as squandering the best opportunity the Iraqi Kurds have ever had to establish an official autonomous region by continuing to act in a divided manner, with party interests put before those of the Kurdish people, and with government resources being plundered for the benefit of the dominant party. When I attended a conference in Berlin in 1999 regarding the status of Iraqi Kurdistan, the Deputy Prime Minister of the KRG based in Suleimaniyah, Dr Kamal Fu'ad, and the Minister of Humanitarian Affairs, Sa'adi Pira, both described to the audience the activities of the KRG in great detail. Their presentations may be characterised as forward-looking.<sup>18</sup> However, the participants and the audience chose to focus once again on the reasons of the internecine divisions and the fighting of the previous 30 years rather than on the steps taken by the Iraqi Kurdish parties to administer the territory. It is with these inconsistencies in mind that I developed the hypothesis to be addressed in this thesis.

---

<sup>16</sup> Sheikmous (1999) "Intra-Kurdish Relations of Kurds of Iraq with Kurds of Other Parts of Kurdistan", in *Irakisch-Kurdistan: Status und Perspektiven*, pp. 53-64. Berlin: Awadani e.V., p. 63.

<sup>17</sup> For an analysis of the relationship between geopolitical realities and domestic necessities in Iraqi Kurdistan, see Stansfield (2000b) "Iraq: Kurdish Chessboard," *Oxford Analytica Daily Brief*, 2 August, III, pp. 8-10

<sup>18</sup> The conference was entitled *Irakisch-Kurdistan: Status und Perspektiven. Ergebnisse einer internationalen tagung 1999 in Berlin* and was held on 9-10 April 1999 in Berlin, Germany.



## **1.1 Statement of Hypothesis**

My hypothesis is that the current divided political and administrative system is a direct manifestation of the historical development and characteristics of the political system of Iraqi Kurdistan. The current division of Iraqi Kurdistan between two separate administrations dominated by the KDP and PUK is, in effect, a function of party dynamics. Attempts at unifying the system allows for instability to develop between the KDP and PUK as such actions force the parties into a position which they do not have the capacity to embrace. In domestic terms, the divided system is not necessarily a weak system. The ability of the two regional administrations to govern their territories has increased due to the stability generated by separation, combined with the effects of the UN oil-for-food programme (SCR 986). However, the role of the political parties within the administration has remained paramount and the identification of party with government is a feature of Iraqi Kurdish politics.

The future political development of Iraqi Kurdistan is dependent upon a range of factors but, within the realm of the political and administrative system, the issue of a unified government as called for by the Washington Agreement of 1998, is of paramount importance. I argue that it is dangerous to attempt to develop the political and administrative system too quickly due to the existence of fundamental problems between the two major parties which need to be resolved. It is therefore forwarded in this thesis that a possible interim solution would be a variant of a consociation-type model of multi-party elite accommodation within a divided political system.

Such a system is already apparent to some degree within the region and exhibits political stability. One government in Erbil dominated by the KDP, and one government in Suleimaniyah dominated by the PUK allows elite accommodation to take place within a political atmosphere not fissured with interfactional rivalry. It can also be seen as a geopolitical safety valve, as the ability of each party to interact with neighbouring countries is enhanced without overtly threatening the status of the other party. Similarly, the division favours the immediate geopolitical concerns of these states which view Iraqi Kurdish political unity with some trepidation. A divided political system therefore has some benefits in the interim period, with intervention from neighbouring states being less destructive, and internal stability conversely enhanced.



## **1.2 Structure of the Thesis**

In order to address this extensive hypothesis, it is necessary to place the Iraqi Kurdish situation within a comprehensive analytical framework, as well as providing a detailed account of its political development. Chapter 2 is the main theoretical and methodological chapter of the work. Within this chapter, I aim to provide an analysis of those aspects of political science theory which can be seen as being applicable to the study of Kurdish politics in Iraq. In studying the political and administrative system of the *de facto* state, it is a necessary and useful task to deconstruct definitions of 'The State' within the theoretical literature, developing a possible continuum of characteristics in which Iraqi Kurdistan may be identified and thereby analysed. Political science theories of consociational political systems are identified as a particular theoretical focus. This body of theory, and the issues generated by the potential analytical and prescriptive application to Iraqi Kurdistan, provides the running analytical theme throughout the thesis. The chapter concludes with an assessment of possible methodological approaches to the study of political and administrative systems, the identification of an appropriate field methodology, and description of the fieldwork undertaken which underlies this thesis.

Chapter 3 addresses the physical and human geography and the economy of Iraqi Kurdistan, and may be viewed as a contextual chapter. The problems of defining the Iraqi Kurdish region are addressed and then a detailed appraisal of the physical geography of the region is provided including an analysis of natural resources and the relationship between the Kurds and the GOI. The human geography of Iraqi Kurdistan is then discussed mainly from the normative viewpoint of political geography, emphasising population figures, changing distributions, and administrative divisions. More anthropological issues are then addressed with an assessment of the linguistic, ethnic, and confessional characteristics of the northern regions of Iraq.

Building on this analysis, the economic characteristics of the region are then analysed. Aware of the role of agriculture in the traditional Kurdish economy, I commence with an exposition of theories which relate the development of political structures to the traditional mode of economic production. Such theories are inherently deterministic, and view the physical environment as a major control on the development of societies and the activities which are undertaken, particularly when the environment is as

rugged as that of Iraqi Kurdistan. Therefore, the progression in this chapter from physical geography, to human geography, and then to economic activity, with the overall aim of providing a sound basis for the analysis of the political and administrative system, may be seen to be a logical progression from the normative viewpoint of these theories. The predominance of agriculture within Iraqi Kurdistan is acknowledged, as is the impact of oil revenue. The deterioration of the agriculture sector due to the *Anfal* Campaigns and the subsequent impact of UN SCR 986 is identified, and the chapter concludes with an assessment of the workings of the contemporary economy.

Chapter 4 charts and analyses the development of the party political system in Iraqi Kurdistan. It is intended that this chapter is more than an account of Kurdish political history, which has been undertaken many times before by other authors. Instead, this chapter analyses the development of the party political system as one that was dominated by political groupings which may be termed as guerrilla movements to one which has modern political parties controlling sophisticated governmental apparatus. The chapter commences with an evaluation of the relevant theory, and particularly prescriptive theories of revolutions which originated with such revolutionary leaders as Mao-Tse Tung and Ernesto Che Guevara. The chapter is then structured chronologically and focuses primarily on those incidents which impacted upon the development of the party political system. This means that this chapter may be somewhat different to conventional accounts of Kurdish politics as, at times, issues are developed which are ignored in other works. The intention of this approach is that an assessment and analysis is created which allows the reader to appreciate fully the complexity of the internal political system that existed in Iraqi Kurdistan on the eve of the *Rapareen* of 1991.<sup>19</sup>

Chapter 5 builds on the analysis presented in the previous chapters. The focus of this chapter is the contemporary party political system of Iraqi Kurdistan. The chapter commences with a chronological analysis of the political history of Iraqi Kurdistan through the 1990s, again focusing on those incidents and moments which were important in the development of the political and administrative system. The major

---

<sup>19</sup> *Rapareen* is the Kurdish term for Uprising.



political parties are then assessed and analysed. In analysing the parties, the KDP and PUK are assessed individually, with their structure, organization, decision-making process, and the role of specific individuals and groupings being appraised, allowing both institutional and character based approaches to be utilised. Each analysis also investigates the relations between parties, the ties with foreign national governments, and the likely future development of the political party in question.

Along with Chapter 5, Chapters 6 and 7 form the core of the thesis. Chapter 6 focuses on the institutions of government which have developed in Iraqi Kurdistan since the *Rapareen* of 1991. The chapter commences with a chronological analysis of the 1990s, focusing on those incidents and moments which impacted upon the development of the system of governance and administration. The main body of the chapter then presents an analysis and assessment of the development of the constituent parts of the governmental system, focusing on the constitutional arguments and problems surrounding the establishment of institutions of government and administration, the creation of a regional legislature, the formation of a regional executive and ministerial portfolios, and the ratifying of a judicial system. This chapter can be seen as undertaking the first part of a modelling process, and presents a morphological assessment and analysis of the Iraqi Kurdish administrative system in the 1990s.

Chapter 7 builds on this morphological analysis. It commences again with a chronological analysis, this time focusing on the interrelationship between party political characters and the development of the administration. The chapter then has as its focus an analysis and assessment of the third cabinets of the KRGs, from 1996-1999. These cabinets formed after the invasion of the city of Erbil by the military forces of the GOI and the KDP in August 1996 and are a manifestation of the divided system which has characterised the *de facto* state to the present day. Being dominated by the KDP and PUK in Erbil and Suleimaniyah respectively, the analysis of the structures and mechanisms of these cabinets not only provides insights into the dynamics of the regional administrations, but also into the relationship between party and government, allowing a comparison to take place between the political decision-making process of the KDP and PUK. Therefore, this chapter can be seen to be following on logically from Chapter 5 as well as Chapter 6.



The chapter concludes firstly with a comparative assessment of the political and administrative system of KDP and PUK controlled territory, and an analysis of the subsequent development of the fourth cabinet which has been in existence in Erbil since October 1999, and the modified third cabinet which has been in existence in Suleimaniyah since the same date.

Throughout these chapters, theories of consociational political systems are forwarded where appropriate as an approach which would allow for peaceful political development within the constraints of the current situation. Similarly, throughout the final chapters focusing on the 1990s, the initiatives of foreign national governments, and particularly the US, aimed at resolving the problems of division currently apparent in the *de facto* state are developed. As the arguments develop, a more prescriptive tone is adopted in order to identify a possible solution to the problems faced by the *de facto* state, and the dangers of progressing too quickly with unification of the two constituent parts, as called for the by the Washington Agreement, for example.

The detailed analysis of the previous chapters culminates with a conclusion which suggests that the greatest challenge the Kurdish parties face in the short and medium term is to be found in balancing internal and external needs. Internally, there is a need to develop a strong, democratic, political and administrative system. Externally, the Kurds have to be careful that their administration, and their *de facto* state, is not perceived as becoming too strong and institutionalised. The failure to achieve the first need would result in internal chaos and political instability. The failure to achieve the latter need would result in neighbouring and influential states being forced to become increasingly politically and militarily involved in the affairs of the *de facto* state, encouraging its rapid demise. Within the current environment of international relations, the Kurds of Iraq have to walk a very narrow path between achieving these two aims. As a conclusion, I forward a variant of a consociational system of governance which would seek to resolve these immediate problems.

## Chapter 2

### Theory and Methodology

#### 2.1 Introduction

The political situation of Iraqi Kurdistan is often said to be unique. Some aspects of it are, but others have corollaries elsewhere, and it is possibly more correct to say that the situation is anomalous. Iraqi Kurdistan is not a state recognised by the international community, for example, yet a domestic political system has emerged which displays highly developed and increasingly sophisticated state-like institutions, attributes and characteristics. The aim of this chapter is therefore two-fold. First, it is necessary to place this anomalous situation within the corpus of literature regarding state characteristics, formation and operation and, second, to develop a theoretical and methodological approach which is most applicable to the study of its political system.

The Kurdish issue is most commonly discussed in terms of the impact Kurdish groupings have on the relations between states in the Middle East in particular. However, by only employing international relations (IR) theories which have an inherent dependency upon the concept of 'the state', it is an impossible task to provide a truly insightful analysis of the Iraqi Kurdish predicament. This problem is common to non-state nations in general, and not only to the Kurds. In emphasising this, Ferguson & Mansbach note that IR theory describes humanity as "*liv[ing] within states, not in the interstices between them . . . . analyses of international relations [can] be no more than logical extensions of the study of the state.*"<sup>1</sup>

Since the establishment of the state system in the Middle East, the Kurds have effectively been located geographically in the delicate boundary regions of Syria, Iraq, Iran and Turkey, which has resulted in them being pawns in the geopolitical arena which is home to a multitude of other states' interests. As such, analyses of Kurdish politics have often focused upon the relation of Kurds as a minority people

---

<sup>1</sup> Ferguson & Mansbach (1988) *The Elusive Quest: Theory and International Politics*. Columbia: University of South Carolina Press, p. 111. Gottlieb furthers the analysis of this problem and calls for a 'states plus nations' approach to resolving the problem of ethnic conflicts caused by state boundaries (Gottlieb (1994) "Nations without States." *Foreign Affairs*, Vol. 73 No. 3, May-June, pp. 100-112.



with state/external involvement in their political development.<sup>2</sup> The reasons for Kurds occupying such a prominent position in the foreign policies of various states can be traced to several inter-related reasons such as the Kurdish region being resource-rich, particularly in oil; in being located in an area of immense geo-economic significance; and for effectively being conveniently placed mercenaries.<sup>3</sup> IR theories therefore have a crucial role in the developing an understanding of the Iraqi Kurdish predicament.<sup>4</sup>

However, since 1991, geopolitical realities have promoted a further development of the Iraqi Kurdish situation, which is now dominated by the issue of self-governance.<sup>5</sup> The change in the global and regional geopolitical system at the end of the 1980s and beginning of the 1990s presented an unprecedented opportunity for the Iraqi Kurds to seize the initiative. As Jalal Talabani stated, "*Saddam Husayn's aggression against Kuwait . . . . led to the emergence of a situation in Iraq which we exploited to establish a free local administration.*"<sup>6</sup>

The existence of this situation in Iraqi Kurdistan has created new opportunities for the study of the Iraqi Kurdish political system. The development of the political system into one which exhibits domestic structures of states, even if not enjoying international legitimacy, has allowed for the application of political science theories,

---

<sup>2</sup> For analyses of the relationship between secessionist minorities and external involvement, see: Heraclides (1990) "Secessionist Minorities and External Involvement," *International Organization*, Vol. 44, No. 3, pp. 341-378; Heraclides (1991) *The Self-Determination of Minorities in International Politics*, London: Frank Cass.

<sup>3</sup> For an analysis of the importance of oil in the formation of Iraq and the inclusion of the southern Kurdish territories, see Nash (1976) "The Effect of International Oil Interests Upon the Fate of an Autonomous Kurdish Territory: A Perspective on the Conference at Sevres, August 20, 1920." *International Problems* (Tel Aviv), Vol. 15, Nos. 1-2, pp. 119-133. For analyses of the impact of geopolitics and geostrategy on the Kurds, see Olson (1994b) "The Kurdish Question and Geopolitical and Geostrategic Changes in the Middle East after the Gulf War." *Journal of South Asian and Middle East Studies* 17 (4), pp. 44-67; Olson (1994c) "The Kurdish Question and the Kurdish Problem: Some Geopolitic and Geostrategic Comparisons," *Peoples Mediterraneens*, Nos. 68-69, pp. 77-94; Khashan (1995) "The Labyrinth of Kurdish Self-Determination," *International Journal of Kurdish Studies*, Vol. 8, Nos. 1-2, pp. 5-32.

<sup>4</sup> For an assessment of the role of ethnic actors in international politics see Esman (1995) "Ethnic Actors in International Politics," *Nationalism and Ethnic Politics*, Vol. 1, No. 1 (Spring), pp. 111-125. Also see Shuhrke & Noble (1977) *Ethnic Conflict in International Relations*. New York: Praeger; Schechterman & Slann (1993) *The Ethnic Dimension in International Relations*. Westport, Conn.: Praeger.

<sup>5</sup> See Freedman & Boren (1992) "Safe Havens for Kurds in Post-War Iraq," in Rodley (ed.), *To Loose the Bands of Wickedness*. London: Brassey's / David Davies Memorial Institute of International Studies, pp 43-92; Gunter (1993a) *The Kurds of Iraq: Tragedy and Hope*. New York: St. Martin's Press; Gunter (1999b) *The Kurdish Predicament in Iraq: A Political Analysis*. New York: St Martin's Press; Freedman (1993) "The War and the New World Order," in Gow (ed.) *Iraq, the Gulf Conflict and the World Community*. London: Brassey's, pp. 183-200.



commonly grouped under the label of 'comparative politics', to Iraqi Kurdistan. It is argued in this thesis that this approach allows for a thorough understanding of the development and operation of the political system of Iraqi Kurdistan, and also allows for realistic solutions to the non-state predicament faced by the Kurds to be forwarded.

### 2.1.1 Aims

It is first necessary to present theories of 'the state'. Related to this, the impact of globalization on state characteristics and formation is also developed in an attempt to demonstrate how variable both theoretical conceptions and practical realities of the state are particularly since the demise of the USSR. A framework is forwarded in which it is possible to place the characteristics of states and non-states alike, and the position of Iraqi Kurdistan identified within it.

The most important use of the concept of 'the state' in this chapter is to identify those methods and techniques employed in the study of state entities, with Iraqi Kurdistan being identified as possessing some attributes of states. Theories of comparative politics are assessed which are of relevance to analysing the Iraqi Kurdish political system with reference to other real-world situations. With these theoretical considerations in place, effectively allowing an analysis and assessment of the development and operation of the political system, theories of consociational political systems are identified at this point as a possible interim solution to the current problems and stresses which are affecting the political system.

## 2.2 Theories of 'The State'

The concept of the state has rightly been part of the primary discourse in the study of the Kurdish predicament. As an approach, it has obvious applications. The Kurdish situation in Iraq is borne out of the hectic state-building which occurred in the Middle East at the beginning of the twentieth century, and it's historical development has to focus on the concept of state as an entity which, paradoxically, the Kurds have been oppressed by, yet aspire to.

---

<sup>6</sup> Jalal Talabani, 14 June 1992, quoted in Gunter (1993) *op. cit.*, p. 87.

To define the state in theory uncovers a continuum, with no one definition of the state being accepted by all, but what may be termed as a resemblance of definitions.<sup>7</sup> The study of the state in practice similarly illustrates that, while a non-state may possess the required criteria and characteristics, it may still not possess statehood. Again, with recognition of states, one may employ a continuum. Even when a state is said to exist, it may not possess the required criteria or characteristics. With regard to this issue, Krasner notes that “*recognition has been accorded to entities that lack either formal juridical autonomy or territory, and it has been denied to states that possess these attributes.*”<sup>8</sup>

It should be noted that these arguments are not being deployed to support the idea that there is a state in Iraqi Kurdistan, rather that our conception of what is a state is, in theory and practice, may be seen to be mercurial. The recognition of states is highly dependent upon the specifics of time and place, and therefore dependent upon geopolitical realities. However, Iraqi Kurdistan can be seen to possess certain attributes of states, if still not enjoying recognition. As this thesis intends to analyse and assess the development and operation of the *de facto* state, it is necessary to develop a working definition of the theoretical concept of the state in which to place the political and administrative system of the region. Once this location-in-theory has been achieved, it is then possible to identify a relevant line of enquiry and methodology.

### 2.2.1 Defining ‘The State’

It has proved to be an insurmountable task for political science theoreticians to provide a working definition of what is effectively the primary unit of analysis of the discipline.<sup>9</sup> Easton, for example, when noting the usage of the term ‘state’ highlighted

---

<sup>7</sup> See Krasner (1984) “Approaches to the State: Alternative Conceptions and Historical Dynamics,” *Comparative Politics*, Vol. 16, No. 2, pp. 223-246; Krasner (1999) *Sovereignty: Organized Hypocrisy*. Princeton, NJ: Princeton University Press, p. 4. Also see Banks and Shaw (1991) *State and Society in International Relations*. New York: St. Martin’s Press.

<sup>8</sup> Krasner (1999) *op. cit.*, p. 220.

<sup>9</sup> For a concise assessment of the development of “the State” and of concepts of sovereignty, see: Philpott (1997) “Ideas and the Evolution of Sovereignty,” in Hashmi, (ed.), *State Sovereignty: Change and Persistence in International Relations*. Pennsylvania: Pennsylvania State University Press, pp. 17-47. For a succinct appraisal of theories of international relations, see Dougherty & Pfaltzgraff (1990) *Contending Theories of International Relations*. New York: Harper and Row; Dunleavy & O’Leary (1987) *Theories of the State*. Basingstoke: Macmillan; Hannum (1990) *Autonomy, Sovereignty, and Self-Determination: The Accommodation of Conflicting Rights*. Philadelphia, PA: University of Pennsylvania Press. For an appraisal of the state-centric nature of academic approaches, see Taylor



the existence of 140 or more definitions, varying ideological bias, the added complexities caused by extensive lay usage, and the difficulties of operationalizing it for empirical research.<sup>10</sup>

The classic definition of a state is found in the 1933 Montevideo Convention on Rights and Duties of States. The convention identifies the state as possessing the following: (a) *a permanent population*; (b) *a defined territory*; (c) *government*; and (d) *capacity to enter into relations with other States*.<sup>11</sup> However, this definition suffers from sovereignty itself being an attribute of statehood, making it legally problematic to create new states.<sup>12</sup> Furthermore, we have to recognise that there is a difference between the criteria which have to be met *before* a state can exist, and criteria which may be deemed as reasons as to why a state *should* exist. Knight identifies an important inconsistency between criteria which must be met, and reasons of state existence when he states “*some common criteria must be met before a State can be said to exist, although the particular reasons why States exist vary quite markedly.*”<sup>13</sup>

#### 2.2.1.1 The State in Theory

Theories of the state are characterised by a composite of different approaches with the result that definitions of the states define everything, yet still seem to be missing some elusive points. Ferguson & Mansbach blame this problem of multiple-nebulous definitions on the phenomenon being studied changing at a rapid rate, making the subject inherently non-objective.<sup>14</sup> Mann defines the ‘messiness’ of the state as being a problem of mixing two different levels of analysis: the institutional and the functional.<sup>15</sup> However, Mann stays with this combination and forwards a mixed but mainly institutional definition which originated with Max Weber. In this definition,

---

(1996) “The Modern Multiplicity of States” in Kofman & Youngs, (eds.), *Globalization: Theory and Practice*. London: Pinter.

<sup>10</sup> Easton (1981) “The Political System Besieged by the State,” *Political Theory*, Vol. 9, No. 3, pp. 303-326, p. 307.

<sup>11</sup> Hannum (1990) *op. cit.*, pp. 15-16.

<sup>12</sup> *Ibid*, p. 15.

<sup>13</sup> Knight (1994) “People Together, Yet Apart: Rethinking Territory, Sovereignty, and Identities,” in Demko & Wood, (eds.), *Reordering the World*. Boulder, CO: Westview Press, p. 72.

<sup>14</sup> Ferguson & Mansbach (1988) *op. cit.*, p. 142.

<sup>15</sup> Mann (1984) “The Autonomous Power of the State,” *European Journal of Sociology*, Vol. 25, pp. 185-213, p. 60.



which encapsulates the majority of elements of most state theories, the state contains four main elements, those being:<sup>16</sup>

1. *A differentiated set of institutions and personnel embodying*
2. *centrality* in the sense that political relations radiate outwards from a centre to cover
3. *a territorially-demarcated area*, over which it exercises
4. a monopoly of *authoritative binding rule-making*, backed up by a monopoly of the means of physical violence.

The definition of the monopoly of rule making and physical violence is a focal point for defining theories of the state. Gross, for example defines the state as “*a coercive institution (organization) that has supreme power over a definite territory and its inhabitants and is vested with monopoly of the use of physical power.*”<sup>17</sup>

Possibly the most defining characteristic of the state is the control of territory as a state cannot exist without a recognisable geographical area of which to govern, administrate, defend, conduct decision-making and demand the allegiance of its subjects. With this in mind, Buzan describes the state as:

“*. . . . represent[ing] human collectivities in which governing institutions and societies are interwoven within a bounded territory. For many, though not all, of the major purposes of interaction within this nexus of territory, government and society is what constitutes the state.*”<sup>18</sup>

Such an approach grounded in the importance of territory may be described as geopolitical, and the relationship between state and territory is firmly supported by the fields of political geography and geopolitics, which believe that power is firmly rooted in the physical nature of the world itself.<sup>19</sup> Parker describes in vivid terms this relationship when he poetically says that “*. . . . just as the giant Antaeus . . . . drew his mighty strength from contact with the ground on which he stood, so the power of the modern state is derived from the territory which it occupies.*”<sup>20</sup>

---

<sup>16</sup> *Ibid*, pp. 60-61.

<sup>17</sup> Gross (1998) *The Civic and the Tribal State: The State, Ethnicity, and the Multiethnic State*. New York: Greenwood Press, p. 8.

<sup>18</sup> Buzan (1991) *People, States and Fear: An Agenda for International Security Studies in the Post-Cold War Era*. London: Harvester Wheatsheaf, p. 60.

<sup>19</sup> Parker (1985) *Western Geopolitical Thought in the Twentieth Century*. London: Croom Helm, p. 1.

<sup>20</sup> *Ibid*.

It is a necessary exercise to address how such definitions relate to the Iraqi Kurdish situation in 1990s. It is the case that the political and administrative system of Iraqi Kurdistan does indeed possess many of the key requirements by which political scientists use to identify states. If we consider the official prerequisites of the Montevideo Convention, or of the theoretical precepts mentioned above, it is possible to argue that the Iraqi Kurdish region possesses a permanent population, defined territory, government and a capacity to enter into international relations, if at an informal level.<sup>21</sup> However, it does not officially possess a standing army, does not enjoy international recognition by the UN, and does not collect taxes.<sup>22</sup> Therefore, when looking at the political and administrative system as a discrete entity, it is possible to say that Iraqi Kurdistan, in domestic terms has several stately attributes. However, in international terms, it possesses few.

#### 2.2.1.2 The State in Practice

How, then, is one to make sense of this set of nebulous and often ambiguous definitions of the state? On one level, it is not too difficult to identify that 'the state' can be defined by reference to control of territory, provision of government institutions, and/or the use of coercion against its own population. However, the problem is complicated depending on the normative viewpoint from which it is studied.<sup>23</sup>

Each approach gives more understanding without fully defining the entity of the state, in theoretical terms. These problems of theory are compounded rather than alleviated by the confusion generated when the state is studied in reality. What may be defined in the theoretical literature in conceptually vague terms manifests as an entity with a variety of often contradictory characteristics.

---

<sup>21</sup> It should be accepted that many of these attributes, including defined territory and government, are themselves *de facto*.

<sup>22</sup> However, the *peshmerga* forces are increasingly organized in the form of a standing army, and attempts are being made to allow the KRG more control over the actions of party militias.

<sup>23</sup> Buzan, focusing on security at a variety of levels, chooses to identify the territorial element; Benjamin & Duvall, studying institutions of government and administration identify the state by what it does, rather than what it is in physical terms, by employing a structural-functional approach; and Gross, in his study of the Palestinians, focuses on the state as a coercive force, perhaps understandably within his case study.



Combined with the identification of different normative approaches, the temporal development of the state should also be considered when seeking a theoretical definition. With an analysis grounded in the writings of Max Weber, Waldner analyses the late development of state institutions in Syria and Turkey. He analyses the transition of states from mediated entities, in which power is exercised directly by elites through alliances with local notables, to unmediated entities in which state institutions have supplanted elites to form links between state economy and society. Logically, therefore, this temporal development of the state would therefore suggest that states existing at different transitional stages may display different characteristics. Waldner goes on to advocate that “states range along a continuum, and no states occupy the extremes of fully mediated or fully unmediated rule.”<sup>24</sup>

Keeping these temporal and normative issues in mind, it would make considerable sense to employ a definition of the state which would allow entities to share some desired characteristics, even though not all will share the same. A state entity could then be defined by a preponderance of defining characteristics, and not by one defining attribute.<sup>25</sup> Such a feature could then be described by recognition of various, but not necessarily all, features deemed to be criteria of state formation. Figure 2.1 displays the idea, showing ‘states’ 1 and 4 having no attributes in common, yet being classified as states because of the shared features of the group.<sup>26</sup>

**Figure 2.1: Schematic Representation of State Characteristics**

		Criteria				
State	1.	<i>A</i>	<i>B</i>	<i>C</i>		
	2.		<i>B</i>	<i>C</i>	<i>D</i>	
	3.			<i>C</i>	<i>D</i>	<i>E</i>
	4.				<i>D</i>	<i>E</i>

<sup>24</sup> Waldner (1999) *State Building and late Development*. Ithaca: Cornell University Press, p. 19; Weber (1946) “Politics as a Vocation,” in Gerth & Wright Mills (eds.) *From Max Weber: Essays in Sociology*. New York: Oxford University Press, p. 82.

<sup>25</sup> Krasner chooses to call the set of criteria a “bundle of properties”. (Krasner (1999) *op. cit.*, p. 220).

<sup>26</sup> This approach is developed from the work of Needham (1981) *Circumstantial Deliveries*. Berkeley: University of California Press.

Similarly, each example of a non-state nation seeking statehood is not governed by the same set of required criteria. It is my opinion that the prescribed tenets for Kurdish statehood are strict, compared to, for example, those of Taiwan. Furthermore, if we accept that the criteria for statehood proves to be variable for real-world examples, then surely there must be an equally variable catalyst, one which suits different examples more than others. The mechanism for such creation of states and the encouragement of criteria has to be the geopolitical specifics of time and space.

Iraqi Kurdistan, it will be argued, goes some way to proving this construct of theory. The current state-ly position of Iraqi Kurdistan can be seen to have been borne from a geopolitical and historical anomaly, and matured in the aftermath of the collapse of the bipolar geopolitical system. The route to its current position (as extemporised in Chapters 5, 6 and 7) is to be found in the characteristics of its geography and population (Chapter 3); its political development (Chapter 4), and; the immediate result of changes in the regional geopolitical balance of the Middle East after the Second Gulf War combined with internal political developments (Chapter 5). However, to commence with, it is necessary to provide a theoretical appraisal of the development of an insurgent political system, theories of administration and governance, as extemporised in the comparative politics literature, and theories of consociational political systems.

### **2.3 The Development of the Political System**

The development of a political grouping from that of a guerrilla movement to a political party is one that is not often addressed in the political science literature. One has to look towards actual revolutionary theoreticians addressing the geopolitics of revolution in the spirit of such characters as Ernesto Che Guvera and Mao Tse-Tung, and as extemporised in the academic literature by few writers but most notably by McColl and Sanger.<sup>27</sup>

---

<sup>27</sup> McColl (1969) "The Insurgent State: Territorial Bases of Revolution." *Annals of the Association of American Geographers*, Vol. 39, No. 4, pp. 613-631; O'Sullivan (1983) "A Geographical Analysis of



### 2.3.1 The Insurgent State

In his insightful analysis of the territorial bases of revolution, McColl develops the theory of the 'insurgent state', which, I will argue, is a close relative of the *de facto* state of Iraqi Kurdistan.<sup>28</sup> McColl sees the nature of a revolution changing with the increasing coalescence of territory under its control, the effect being that a revolution has a "territorial imperative".<sup>29</sup> He notes that;

" . . . . modern national revolutions have accepted as a basic tactic the creation of a territorially based anti-state (insurgent state) within the state. . . . The mechanism is the creation of territorial units compete with all the attributes of any legitimate state, namely a *raison d'etre*, control of territory and population and, particularly, the creation of its own core area and administrative units as well as a power base in its guerrilla army. . . . it is useful to view contemporary national revolutions as a process of the evolution of a territorially based political unit within a politically hostile territory."<sup>30</sup>

McColl argues that the "territorial imperative", the drive to create an insurgent state, has the following benefits for a revolutionary movement:<sup>31</sup>

1. It acts as a physical haven for the security of its leaders and continued development of the movement;
2. It demonstrates the weakness and ineffectiveness of the government to control and protect its own territory and population;
3. Such bases provide necessary human and material resources;
4. Finally, the insurgent state and its political administrative organizations provide at least an aura of legitimacy to the movement.

Interestingly, the theory of the insurgent state does not specify a process of state breakdown, rather it envisages an effort to gradually replace state government through the geopolitical tactic of the attrition of government control over a specific territorial area.

---

Guerrilla Warfare," *Political Geography Quarterly*, Vol. 2, No. 2, pp. 139-150; Glassner (1996) *Political Geography*. New York: John Wiley & Sons.

<sup>28</sup> McColl (1969) *op. cit.*; Mao Tse-Tung (1954) *Selected Works*, Vol. II. New York: International Publishers; Guevara (1961) *Guerrilla Warfare*. University of Nebraska Press.

<sup>29</sup> McColl (1969) *op. cit.*, p. 614. Also see Miller & Aya (1971) *National Liberation: Revolution in the Third World*. London: Collier/Macmillan.

<sup>30</sup> *Ibid.*

The origins of the territorial imperative approach is central to the writings of the Chinese revolutionary leader Mao Tse-Tung.<sup>32</sup> The three stages of revolution as discussed by Mao Tse-Tung are a period of mobile war, followed by guerrilla war, and regular war (equilibrium). McColl discusses these phases in geographical terms as “each stage represent[ing] the evolution of an insurgent state and its ability to increase the area under its political and military control.”<sup>33</sup>

Such an approach allows the reality of a national revolution, the aim of controlling territory, to become a part of the theoretical considerations. However, theories of insurgency, of which the above are classic examples, tend to focus on the *aims* of the insurgents. Little has been written about the *impact* the achievement of the aims has on the successful political grouping.

### 2.3.2 Application to Iraqi Kurdistan

The *de facto* state in Iraqi Kurdistan may therefore be discussed as being at least a close relative of the insurgent state. The insurgent state is described as being able to force the government troops to concentrate in larger cities and to protect the insurgent areas from government attack. The *de facto* element may be seen as being a variant of this. In a *de facto* insurgent state, the revolutionary movement is closely aligned with the three-stage development of the territorial imperative. However, changes in the geopolitical balance previously governing the characteristics of the insurgency result in either a rapid aggregation or de-aggregation of territory, and, therefore, the relationship between geopolitics and state entity formation is readily apparent.<sup>34</sup>

McColl goes further to note the development of a shadow administration in the insurgent state. He describes such an organization developing from the need to coordinate the national revolution when it had been divided amongst different areas. The development of an administration within an insurgency structure was also discussed by Che Guevara and has some parallels in Iraqi Kurdistan with the Kurdish

---

<sup>31</sup> *Ibid.*

<sup>32</sup> Mao Tse-Tung (1954) *op. cit.*, pp. 183–184.

<sup>33</sup> McColl (1969) *op. cit.*, p. 616.

<sup>34</sup> Such a de-aggregation in Iraqi Kurdistan could be seen in 1975 with the changing regional geopolitical characteristics caused by the Algiers Agreement between Iraq and Iran. An aggregation can be seen to have taken place in the aftermath of the Second Gulf War in 1991, creating a regional geopolitical imbalance.



political parties operating an administrative type organization for their mountain-based *peshmerga*.<sup>35</sup> However, the overall target is to establish a state system, particularly as the increased size of area and the population within the boundaries of the insurgent state creates a need to establish an administration to provide for the civilian population.<sup>36</sup>

All the main revolutionary writers, including Mao Tse-Tung, Vo Nguyen Giap, and Che Guevara continually stressed the importance of establishing base areas to the path of revolutionary success.<sup>37</sup> In addition to internal advantages, the insurgent situation also benefits from external recognition from the development of an administration. However, in the Kurdish case, changing geopolitics has meant that the revolutionary movement has had to exercise extreme caution in not showing the weakness of central government authority in Iraqi Kurdistan, and certainly not showing a willingness to further the insurgency to a level of appearing to seek true independence.

### 2.3.3 Conclusion

This corpus of theory has significant relevance for assisting in the understanding of the development of the political system of Iraqi Kurdistan. Particularly in the PUK, revolutionary leaders were close followers of the writings of combatants in similar struggles, and the impact of Mao Tse-Tung on the development of the political system throughout the 1970s and 1980s is difficult to underestimate. This means that the application of the insurgent state theory to the Iraqi Kurdish situation is valid, both in descriptive analytical terms, as well as being understood as a prescriptive theory.<sup>38</sup>

---

<sup>35</sup> Interviews with Jabar Farman, Suleimaniyah, 18 June 1998; Sami Abdul Rahman, Salahadin, 27 June 1998; Shwan Qliasani, Suleimaniyah, 4 August 1999; Hackam Khadr Hama Jan, Suleimaniyah 6 September 2000.

<sup>36</sup> McColl (1969) *op. cit.*, p. 626.

<sup>37</sup> *Ibid*, p. 628.

<sup>38</sup> The most dominant faction of the PUK, the *Komala*, was previously known as Marxist-Leninist *Komala*, and then later described itself as a Maoist organization. Its teachings throughout the 1980s were based mainly on the writings of Mao Tse-Tung, and the majority of the current leadership of the PUK were originally members of the *Komala*, including Nawshirwan Mustafa. Even though the PUK has now grown away from Maoist-dominated theories of revolution, the imperative is still strong. Shwan Qliasani, for example, a previous *Komala peshmerga* and now member of the PUK Foreign Relations Bureau, described to me perfectly the different stages of the Iraqi Kurdish struggle with reference and according to the three stages of the insurgent state, for example. Interviews with Shwan Qliasani, Suleimaniyah, 18 June 1998, 4 August 1999; Nawshirwan Mustafa Amin, Suleimaniyah, 29 July 1999; Jalal Talabani, Suleimaniyah, 11 September 2000.

## **2.4 Comparative Political Theories**

If we consider that forces of geopolitics and internal insurgency have resulted in the establishment of a *de facto* state, and, in conceptual terms, it is acceptable to position this entity on a continuum of state-characteristics, the next stage of analysis would be to study the political system of the *de facto* state entity.

The methodology I am choosing to employ in the analysis of the Kurdish situation in Iraqi Kurdistan is best described as an eclectic political science approach. In effect, I am choosing to employ theories and methodology grouped under the term of 'comparative politics'. However, rather than taking a political or state system which is well-established, recognised and accepted, I am applying the tenets of the theory group to assist in the provision of an understanding of the character and dynamics of the Kurdish party political system and *de facto* governance apparatus.

This is a difficult task and requires the development of the relevant theories alongside a detailed appraisal of the internal politics of Iraqi Kurdistan to achieve a coherent analysis. While it is relatively straightforward to produce a political history of Iraqi Kurdistan, it is considerably more demanding to produce an analysis of the mechanics of Iraqi Kurdish politics. It is only with a full armoury of theoretical and methodological approaches and extensive fieldwork producing detailed knowledge of Kurdish politics in action that the aims of this thesis can be realised.

### **2.4.1 Aims**

The approach has to be multi-tooled to reflect the many different areas of an holistic political system, which include the internal workings of the Iraqi Kurdish politics, from party and factional activities, legislature and judiciary, to cabinet, executive and bureaucracy. This section will therefore discuss;

1. The general framework to be employed, and;
2. The potential strengths and weaknesses of the aforementioned theories both in general and in the application of them to Iraqi Kurdistan.

To commence with, I will undertake an appraisal of the general framework of this section, focusing on the development of the theories which are part of the comparative



politics approach, and the applicability of this body of thought to the Iraqi Kurdistan region.

#### 2.4.2 Methodological Framework

Throughout this section, I intend to promote simultaneously the validity of the approach and the potential for developing new theoretical dimensions to the study of scenarios akin to the Iraqi Kurdish situation. To achieve these aims, the section is divided into an assessment of the political system as the overall unit of study, the development of relevant theoretical approaches, and the applicability and problems presented by the application of such theories to such a region.

##### 2.4.2.1 State, Non-State, or *De Facto* State? The Study of the Political System

Theories of politics and governance which exist under the umbrella of comparative politics are founded in the analysis of established, and often state, systems and the discipline of comparative politics originates in the study of nation-states and mainly the liberal-democratic polities. However, this should not preclude these theories from being applied to other related areas of study; this type of theoretical approach is not solely the domain of nation-state analyses.

The theories and methodology of comparative politics can similarly be applied to *de facto* states, non-state regions, and territory best described as being under the control of irregular authorities. Comparative politics provides a framework of analysis and a collection of theories aimed at facilitating the systematic analysis of the landscape of politics and governance.<sup>39</sup> The fact that it has primarily been developed and used to investigate the governance and politics of nation-states does not preclude it from being applied to Iraqi Kurdistan. While many of the theories of this discipline have been *developed* by studying nation-states, they *originated* and were conceived by analysing structures of a much smaller scale, of varying complexities, and of varying locations and levels of development.<sup>40</sup> Furthermore, many of the constituent theories of comparative politics were initially developed in other fields rather than in political science, and most notably in sociology with the study of organizations, and

---

<sup>39</sup> See Kriek (1995) "David Easton and the Analysis of Political Structure," *Journal of Theoretical Politics*, Vol. 8.

anthropology with the study of indigenous political systems. The provision of a recognized state entity should therefore not be regarded as a pre-requisite for the application of theories of comparative politics.

Furthermore, most comparative political research is designed specifically not to promote the conceptualization of the nation-state in the analysis, so as to allow a truly comparative perspective to take place in understanding politics and governance in different systems under different conditions.<sup>41</sup> It is for this reason that I intend to use the term 'political system' rather than 'state system' as the encompassing unit of analysis.<sup>42</sup> In support of this point, Blondel states that:

*“ . . . the concept of the state is not truly universal. It can be used only with respect to those polities which have organized administrative arrangements. Admittedly, in the contemporary world, polities tend normally to take the form of states, but this is not universal, as for instance during a pre-independence process or when a guerrilla movement occupies a portion of territory which it claims to be liberating.”*<sup>43</sup>

The grouping of theories commonly included under the umbrella of comparative politics is therefore of great use in being used to analyse the situation of politics and governance in Iraqi Kurdistan, particularly since 1991.

#### 2.4.2.2 Comparative Political Theory

The study of governance and politics is encompassed by a wealth of theoretical material ranging from general theories attempting to explain the behaviour of entire systems and institutions, to highly specific ones relating to the behaviour of individuals.<sup>44</sup> For the purposes of this thesis, a combination of different aspects of these theories is necessary to produce an understanding of the political dynamics, particularly of a region such as Iraqi Kurdistan which has inherited administrative structures and procedures from the GOI, and decision-making dynamics characteristic

---

<sup>40</sup> Almond (1968) "Comparative Politics," in Sills, (ed.), *International Encyclopaedia of the Social Sciences*, vol. 13. New York: Macmillan, pp. 331-336.

<sup>41</sup> Blondel (1995) *Comparative Government: An Introduction*. London: Prentice Hall/Harvester Wheatsheaf, p. 17.

<sup>42</sup> For an assessment of the applicability of the concepts of the 'political system' and 'the state', see Easton (1981) *op. cit.*

<sup>43</sup> Blondel (1995) *op. cit.* p. 17.

<sup>44</sup> Peters (1998) *Comparative Government: An Introduction*. London: Prentice Hall/Harvester Wheatsheaf, p. 109.



of indigenous tribal groupings and political parties borne out of armed rebellion. However, an eclectic methodology is perhaps not overly radical as political science theoreticians in general promote the benefits of such a multi-tooled approach. Peters favours such an approach, as shown in his following statement:

*“Despite the claims of generality of several of these theoretical approaches . . . . none of the theories provides a sufficient explanation for all political outcomes and political behaviour. Researchers should therefore look at a variety of explanations in order to gain that more complete explanation.”*<sup>45</sup>

In describing the application of these sets of theories to this thesis, I will undertake a division based upon the differing levels of analysis, rather than focusing on the chronological aspects of the development of the theories, which would tend to discredit the older approaches of structural-functionalism. In this section, I present a brief overview of the thrust of the theoretical approaches, the historical development and key papers, and the potential benefits and pitfalls of applying such theories to Iraqi Kurdistan.

#### 2.4.2.2.1 *The Holistic Approach*

The evolution of theoretical approaches in political science has a complex history, which is similarly mirrored in the social sciences in general. Within political science, the development of theoretical approaches to understanding political structures and activities has commenced from what may be described as the study of institutions and constitutions, developing into structural functionalism and looking at holistic systems. This grouping of theories can commonly be divided into systems theory and a structural-functionalist theoretical approach.

The development of systems theory is associated with the work of Easton and formed the foundation of comparative approaches in political science.<sup>46</sup> In the 1960s and 70s, Easton developed the idea that political activities and governance could be characterised as a system of inputs and outputs existing in an environment of demands and supports from the populace.<sup>47</sup> The outputs of the system were policies, with in-

---

<sup>45</sup> *Ibid.*

<sup>46</sup> Hague, et. al., (1998) *Comparative Government and Politics: An Introduction*. Basingstoke, Hants: Macmillan, p. 33.

<sup>47</sup> Easton (1953) *The Political System*. New York: Knopf Press, pp. 96-100.

built feedback loops in operation.<sup>48</sup> The government was essentially positioned in the centre of this system, translating 'inputs' into 'outputs' in what became known as the 'Black Box'. The 'Black Box' became to be identified as the depository of unimaginable mysteries of government,<sup>49</sup> but it is here that the controllers of the decision-making process reside, and effectively where the tenets of systems analysis needs assistance from more behavioural type theories to account for the characteristics of leaders and the political elite.

As was the case with defining the concept of 'The State', definitions of the political system are equally nebulous. Almond's 1960 definition describes "*systems of interactions . . . . which performs the functions of integration and adaptation*".<sup>50</sup> Deutsch sees the system as being equipped to collect information and to transmit this information into the decision-making process.<sup>51</sup> Critics of systems theory focus on the lack of importance given to personalities. Hoffman, for example, derides systems theory in international relations and politics for combining the ideal of a deductive science with the desire to achieve predictability, ultimately producing a tautological body of theory and theoretical approaches.<sup>52</sup> Furthermore, Hoffman contends that systems theory does not "*capture the stuff of politics*", emphasising that the approach reduces individuals and societies to little more than communication systems.<sup>53</sup>

I agree with these criticisms, but feel that the application of a systems theory approach has much to offer a study of the Iraqi Kurdish situation. Within Iraqi Kurdistan, the criticism of the administration and political parties has often been at a systems level, for example in questioning the ability of the local administration to perform their tasks due to supposed poor organization. Similarly, with the study of Kurdish political parties, there has been no real attempt to understand political dynamics beyond the analysis of the motives of a handful of key players. I argue that tenets of systems

---

<sup>48</sup> Peters (1998) *op. cit.*, p 112.

<sup>49</sup> Calvert (1983) *Politics, Power and Revolution: An Introduction to Comparative Politics*. London: Wheatsheaf Books, p. 117.

<sup>50</sup> Almond (1960) "Introduction: A Functional Approach to Comparative Politics," in Almond & Colman, (eds.), *The Politics of Developing Areas*. Princeton, NJ: Princeton University Press, p. 7.

<sup>51</sup> Deutsch (1963) *The Nerves of Government*. New York: Free Press, pp. 250-254.

<sup>52</sup> Quoted in Dougherty & Pfaltzgraff (1990) *op. cit.*, pp. 172-173.

<sup>53</sup> *Ibid.*



theory, combined with the study of individual characters, will provide a detailed picture of the arena in which politics and administration in Iraqi Kurdistan exist.

As the contemporary of systems theory, structural-functionalism assumed that all political systems would have certain functions that they would have to perform. Almond & Colman, and subsequently Almond & Powell, developed structural functionalism in political science theory further by arguing that governments had the requisite functions of interest articulation, interest aggregation, rule-making, rule-application, rule adjudication, political communication and socialisation and recruitment.<sup>54</sup> The first four of these groups relate to the process by which decisions are made and implemented, the last three to the maintenance of the political system.<sup>55</sup>

The underlying assumption of the structural functionalists was that political systems, no matter at what stage of development or typology, would have to perform these functions. The task of the political scientist was then to analyse similarities and differences in attempting to achieve these tasks.<sup>56</sup> It therefore shares a similar positive attribute with systems theory in that it had applications beyond Western political systems. The benefits of the structural-functionalist approach in political science are emphasised by Peters:

*“ . . . the structure of a public organization in the United Kingdom is not a great deal different from that of one performing a similar function in Uganda. This relative similarity allows us to assess the possible effects of small organizational differences. Further, it allows us to assess the effects of a number of cultural and environmental factors on the behaviour of administrators.”*<sup>57</sup>

Structural-functionalism therefore leaves many points of analytical direction available. The functionalism was left to the theory itself – it was assumed that such activities of political dynamics were universal – and the analysis was one of studying the role of different structures and institutions in achieving these aims, often with a

---

<sup>54</sup> Almond (1960) *op. cit.*, pp. 26-58; Almond & Powell (1966) *Comparative Politics: A Developmental Approach*. Boston, Mass.: Little, Brown & Co., pp. 13-16; Peters (1998) *op. cit.*, p. 114.

<sup>55</sup> Hague, *et. al.*, (1998) *op. cit.*, p. 33.

<sup>56</sup> Almond (1960) *op. cit.*, p. 11; Almond & Powell (1966) *op. cit.*, pp. 27-34. Also see Lane (1994) “Structural-Functionalism Reconsidered: A Proposed Research Model,” *Comparative Politics*, vol. 26, no. 4, pp. 461-478; Hay (1995) “Structure and Agency,” in Marsh & Stoker, (eds.), *Theory and Method in Political Science*. New York: St. Martin’s Press.

<sup>57</sup> Peters (1995) *The Politics of Bureaucracy*. New York: Longman Publishers, p. 6.

comparative perspective.<sup>58</sup> This position has been developed upon recently by Lane who argues that a structural-functionalist approach can be blended with individual motivational theories and the employment of a structural-functionalist approach at a micro-analytical level rather than as a whole system theory.<sup>59</sup> This would go some way to alleviating the impersonality of the structural-functionalist approach. Peters supports such a synthesis and notes that;

*“Given that all government decision-making ultimately comes down to decisions made by individuals or groups of individuals, the failure to build in more realistic assumptions about how humans influence system behaviour is an almost fatal flaw for these [structural-functional] theories.”*<sup>60</sup>

#### 2.4.2.2.2 *The Behavioural Approach*

A backlash against systems and structural-functionalist theories ensured particularly from the mid-1960s, resulting in a focus of the behaviour of individuals. This approach was based upon the recognition that what was stated formally, and identified by institutional analysis, was not as important in the understanding of comparative politics as what took place in reality.<sup>61</sup>

*“[The behavioural] view was a reaction against an analysis of institutions that was based primarily on the formal examination of their powers, instead of encompassing what actually happened in the institutions – that is the behaviour of the actors within them.”*<sup>62</sup>

The key exponent of this approach is Dahl.<sup>63</sup> It is between these two poles that political science, and the fledging umbrella approach of comparative politics, found itself with exponents focusing on what increasingly became to be seen as one of two mutually exclusive positions. However, both sets of theories have a role to play in understanding political dynamics within parties and government, and should be seen as complementary directions rather than developments superseding each other.<sup>64</sup>

---

<sup>58</sup> Hague, *et. al.*, (1998) *op. cit.*, p. 35.

<sup>59</sup> Lane (1994) *op. cit.*, p. 466.

<sup>60</sup> Peters (1998) *op. cit.*, p. 116.

<sup>61</sup> Almond (1968) *op. cit.*, pp., 331-336; Blondel (1995) *op. cit.*, p. 9.

<sup>62</sup> Blondel (1995) *op. cit.*, p. 10.

<sup>63</sup> Dahl (1963) *Polyarchy*. New Haven, Conn.: Yale University Press.



#### 2.4.2.2.3 *The Neo-Institutional Approach*

The synthesis of these groups occurred from the mid-1980s onwards with the promotion of what was termed neo-institutional theory within political science, taking in the different approaches of behavioural and institutional theories, by such academics as March & Olsen, Apter, and Badie.<sup>65</sup> The amalgamation of these two bodies of theory allowed a balanced view to emerge which takes into account both the importance of institutions and the behaviour of political actors.<sup>66</sup> It is this synthesis which is utilised as the basis of the theoretical approach of this thesis. It provides a malleable framework allowing the complexities of the Iraqi Kurdish situation to be addressed, including the unique development of the structure of the parties and the government, and the inter-personal relationships occurring within the structures. This approach is supported by Peters who, when referring to comparative political theory and applications to the study of administrations, states that “*what is needed . . . . is a realization that . . . . institutional analysis, albeit combined with more behavioural analyses, is important for the development of comparative political theory.*”<sup>67</sup>

#### 2.4.2.2.3 *Conclusion*

The framework established by the holistic institutional theories has made it possible to study the spectrum of regimes and governance not only in order to justify different systems, but also in order to analyze their mechanisms.<sup>68</sup> The framework elaborated by Easton allowed for the combined study of the elements in *any* society which form a political system. The elements of the political system such as presidencies, cabinets and legislatures can be generically described as ‘structures’ or ‘institutions’, and the analysis of the activities and characteristics of such structures is the basis of the structural-functionalist theories.

However, it would not be beneficial to analyse the Iraqi Kurdish situation solely with the application of systems and structural-functionalist theories. It is an important

---

<sup>64</sup> Peters (1995) *op. cit.*, p. 5.

<sup>65</sup> March & Olsen (1984) “The New Institutionalism,” *American Political Science Review*; (1989) *Rediscovering Institutions*. New York: Free Press; Apter (1991) “Institutionalism Reconsidered,” *International Social Science Journal*, Vol. 129, pp. 463-481; Badie (1989) “Comparative Analysis in Political Science: Requiem or Resurrection?” *Political Studies* Vol. 37, No. 3.

<sup>66</sup> Blondel (1995) *op. cit.*, p. 10; Peters (1999) *Institutional Theory in Political Science: The New Institutionalism*. London: Pinter Press, p. 142.

<sup>67</sup> Peters (1995) *op. cit.*, p. 5.

<sup>68</sup> Blondel (1995) *op. cit.*, p. 8.

approach as it allows an identification to take place of what the Kurdish political system looks like from the outside and how, in institutional terms, it compares with other systems of politics and governance. These theories are a considerable assistance in identifying the existence of a state-type structure in Iraqi Kurdistan, but there is a predominance of individual rule in the region which they simply cannot account for. The formal examination of institutional existence and powers does not give an idea of what actually happens *inside* the institution in question of the political structure as a whole. An idealised, official, version of the activities of the political system is developed, but there is little understanding of the dynamics and processes which occur in reality. Systems analysis is therefore a useful tool to bring out a little known aspect of the Iraqi Kurdish region, but has to be combined with an approach which allows for the analysis of political actors. This combination of different theoretical approaches to the study of political systems is essentially the direction promoted by the neo-institutionalist school of comparative political theory.

#### 2.4.2.3 Application

In discussing the applicability of such theories, it is possible to identify two main points of concern. Firstly, how correct is it to apply theories to such an area as Kurdistan which were developed primarily by studying western political systems? Secondly, how is it possible to employ theories of comparative government when the study is concerned with one region, which, while possibly displaying state characteristics, is not actually recognised as a state?

##### 2.4.2.3.1 *First World Statist Theories for a Third World Non-State?*

A problem with applying these theories to Iraqi Kurdistan is that most of them have been developed by studying the developed world, with little reference to the developing world or the Middle East. Similarly, there are a number of theories of political party operation, but again most of these are centred on the study of developed world systems. There are a few exceptions. Blondel studies the political executives of developing countries, and LaPalombara & Weiner study third world political development.<sup>69</sup> However, there is admittedly a gap both in application of the present theory and subsequent development of theories to study non-western and non-



state situations. The defence of the usage of this set of theories is that the framework of systems analysis and neo-institutionalism allows for the application of relevant theories to new political scenarios and, if correctly applied, could result in the establishment of further theoretical perspectives. This defence is developed further in the response to the second problem.

#### 2.4.2.3.2 *The Comparative Aspect*

Problems may arise in defending the 'comparative' portion of the analysis – after all, no other place shares the characteristics and history of Iraqi Kurdistan. However, if we accept that the literature of this group of theories provides a detailed understanding of governance and political activities and structures, thereby providing an historical catalogue of theoretical thinking regarding structure, characteristics and dynamics of politics and governance, we are, in effect, interestingly supported in a single case-study approach by the theoretical aspects themselves. If what is being investigated by the study in question is reasonably uncommon, and possibly unique, then the possible number of comparative cases is obviously reduced. For example, in examining the governance and politics of non-state regions, the choice appears to be limited to a handful of cases, and then if the relationship between political parties and a *de facto* government administration is introduced, the choice narrows down dramatically.<sup>70</sup>

Peters forwards two compelling arguments as to why comparative theory can be employed on singular case studies. First, he states that the primary reason is to utilise a very particular case to characterise a phenomenon that appears to be especially apparent in that one case. The study of the individual case is therefore best seen as an exercise leading, hopefully, to a statement about the phenomenon to add to the body of theory.<sup>71</sup> Rose named this approach as being the “*extroverted case study*”, noting that a study of a single country may become so if it employs concepts that make it

---

<sup>69</sup> LaPalombara & Weiner (1966) *Political Parties and Political Development*. Princeton: Princeton University Press; Blondel (1985) *Government Ministers in the Contemporary World*. London: Sage.

<sup>70</sup> See Peters (1998) *op. cit.*, p. 61.

<sup>71</sup> Peters (1998) *op. cit.*, p. 62.

possible to derive generalizations that can be tested elsewhere.<sup>72</sup> In defence of the singular case-study approach, Peters states that:

*“The researcher has identified . . . an important exception to the prevailing theory, or a case which demonstrates a phenomenon that previously had been excluded from the literature . . . the purpose of the extroverted case-study then becomes to explore fully this one case with the existing theory in mind, with the expectation of elaborating or expanding that body of theory with the resulting data.”<sup>73</sup>*

#### 2.4.2.3.3 Consociational Political Systems

A focus of this thesis is to first identify a typology for the type of political system which has existed in Iraqi Kurdistan since 1991, and, second, to identify a possible model for the continued peaceful development of the political system, at least in this current period of political uncertainty in Iraq as a whole. It is argued that theories of consociational political systems can be employed to analyse the reasons behind political instability in Iraqi Kurdistan in the first half of the 1990s, and the subsequent stability which has been apparent particularly toward the end of the 1990s. Further, consociational political theories are also forwarded in a prescriptive manner as a possible model for the continued peaceful political development of the Iraqi Kurdish region at this uncertain period for Iraq.

Iraqi Kurdish society conforms to the conditions of a “*deeply divided society*” defined by Lustick as follows;

*“[a society is deeply divided] if ascriptive ties generate an antagonistic segmentation of society, based on terminal identities with high political salience, sustained over a substantial period of time and a wide variety of political issues.”<sup>74</sup>*

Kurdish society may therefore be described as segmented (with cleavages of either a tribal, social, party political or geographic nature), with political direction being seemingly controlled by small groupings of often-antagonistic political elites. It is

<sup>72</sup> Rose (1991) “Comparing Forms of Comparative Analysis,” *Political Studies*, Vol. 39, No. 3, pp. 446-462, p. 454.

<sup>73</sup> Peters (1998) *op. cit.*, p. 62.

<sup>74</sup> Lustick (1979) “Stability in Deeply Divided Societies: Consociationalism versus Control,” *World Politics*, Vol. 31, pp.325-344, p. 325.



therefore argued that the development of the Iraqi Kurdish political system requires the successful management of societal cleavages alongside elite accommodation.

In discussing the problem of the segmented society of Northern Ireland, O'Leary identifies that such societies are unsuited to the Westminster model of government of single-party governments imposing its will within a unitary state.<sup>75</sup> Similarly, in discussing the future political development of South Africa, McGarry & Noel identify that the Westminster model has a disastrous record in divided societies.<sup>76</sup> The model which is identified as being applicable to promoting stability within divided societies is the consociational model of Arend Lijphart.<sup>77</sup> Lijphart's theory of consociational democratic systems combines the analysis of the institutions of state with the importance of managing political elites in a segmented society, in effect combining a structural approach with the need to include behavioural aspects. Theories of consociational political systems can be considered to be a leitmotif of this thesis. The main analysis builds toward a conclusion which suggests a possible consociational solution to the immediate problems of the Iraqi Kurdish political and administrative system. As such, the theories are developed towards the end of the thesis once the evidence has been presented by analysing the political and administrative system with the aid of the mentioned bodies of theory.

The model of consociational political systems was developed by Lijphart in the 1960s who was researching how deeply segregated societies managed their latent conflicts.<sup>78</sup> He focused primarily on plural societies home to different segmental groupings, and in particular the Netherlands, Austria and Switzerland, and posed that these countries in particular possessed subculturally segmented societies, but entertained stable democracy as easily as states with less potential detrimental societal cleavages.<sup>79</sup> He

---

<sup>75</sup> O'Leary (1989) "The Limits to Coercive Consociationalism in Northern Ireland," *Political Studies*, XXXVII, pp. 562-588, p. 562.

<sup>76</sup> McGarry & Noel (1989) "The Prospects for Consociational Democracy in South Africa," *Journal of Commonwealth and Comparative Politics*, Vol. 27, pp. 5-22, p. 6.

<sup>77</sup> Lijphart (1968) *The Politics of Accommodation: Pluralism and Democracy in the Netherlands*. Berkeley: University of California Press; (1969) "Consociational Democracy" *World Politics*, Vol. 21, pp. 207-225; (1977) *Democracy in Plural Societies*. Yale University Press.

<sup>78</sup> See Halpern (1986) "The Disorderly Universe of Consociational Democracy," *West European Politics*, Vol. 9, pp. 181-197, p. 182; Najem (1998) *Collapse and Reconstruction of Lebanon*, University of Durham: Centre for Middle Eastern and Islamic Studies Middle East Papers, No. 59, p. 3.

<sup>79</sup> Halpern (1986) *op. cit.*, p. 182; Kaiser (1997) "Types of Democracy: From Classical to New Institutionalism," *Journal of Theoretical Politics*, Vol. 9, No. 4, pp. 419-444, p. 427.

defined his model as “government by elite cartel designed to turn a democracy with a fragmented political culture into a stable democracy.”<sup>80</sup> The role of leaders of rival groups is therefore of paramount importance in societies where political culture is deeply fragmented.<sup>81</sup> Lijphart identified, that the following factors deemed to be conducive in the development of a consociational system:<sup>82</sup>

1. The elites must possess the ability to accommodate divergent interests which exist within the society;
2. The elites must have the ability to transcend cleavages;
3. There has to a commitment from the elites to maintain the consociational system;
4. All of the above factors are based upon the assumption that the elites understand the perils of political fragmentation.

It is argued that the future peaceful development of the political system in Iraqi Kurdistan could be achieved by the adoption of a consociational model. However, such an application has to be carefully designed. Consociational theory is often regarded as problematic to apply, and, in the case of Iraqi Kurdistan itself, can be seen to have failed during the power-sharing period of 1991-1996. But, since 1996, the political system has displayed increasing stability due to the presence of a political system which is managing a segmented society with elite accommodation in a variant of a consociational system.

A traditional consociational system would involve the existence of political elites in some form of coalition government with confidence-building measures being actively enforced. This was in effect from 1991-1996 but, due to a badly designed electoral system and political immaturity of the principal political parties, the political system and democratic process failed and fighting ensued. After geopolitical pressures resulted in the geographic division of the Iraqi Kurdish region between the KDP and PUK, with each dominating its strongholds (Dohuk-Erbil, and Suleimaniyah-Kirkuk respectively), the political system is again reasonably stable, under what may be described as a geographic variant of a consociational political system, with the

---

<sup>80</sup> Lijphart (1969) “Consociational Democracy,” *World Politics*, Vol. 21, p. 216.

<sup>81</sup> *Ibid*, p. 208. Also see Lustick (1997) “Lijphart, Lakatos and Consociationalism,” *World Politics*, Vol. 50, pp. 88-117, pp. 91-92.

<sup>82</sup> Lijphart (1969) *op. cit.*, p. 216. Also see Najem (1998) *op. cit.*, pp. 3-4.



political elites also divided, although with limited meetings occurring, and coordination of public service governmental functions taking place.

Within Iraqi Kurdistan, where traditional tribal and geographical political cleavages have been deepened through the antagonistic development of the party political system, the current situation displays separation of sub-cultures to an extreme degree led by political elites. Therefore, for understanding the current situation of an administration and territory divided according to party-factional geographical areas, I forward a geographical variant of the consociational model, where the sub-groupings are, in the first stage, wholly divided. Such a model still has elite interaction occurring at the highest levels of the political parties, but may be characterised as being separate in administrative terms, thereby ensuring elite accommodation in a volatile political environment. Theories of consociational political systems are forwarded in the conclusion as a possible interim solution to the future problems of developing a more efficient system of governance. For example, the further development of the political system may see the appearance of the more conventional characteristics identified by Lijphart, which would be, in effect, a unified governmental system with the restraints a consociational system of government provides.

#### 2.4.2.3.4 *Conclusion*

The framework established by the holistic institutional theories made it possible to study the whole spectrum of regimes and governance not only in order to justify different systems, but also in order to analyze their mechanisms.<sup>83</sup> The framework elaborated by Easton allowed for the combined study of the elements in *any* society which form a political system. The elements of the political system such as presidencies, cabinets and legislatures can be generically described as 'structures' or 'institutions', and the analysis of the activities and characteristics of such structures is the basis of the structural-functionalist theories.

However, it would not be beneficial to analyse the Iraqi Kurdish situation solely with the application of systems and structural-functionalist theories. It is an important approach as it allows an identification to take place of what the Kurdish political

---

<sup>83</sup> Blondel (1995) *op. cit.*, p. 8.

system looks like from the outside and how, in institutional terms, it compares with other systems of politics and governance. These theories are a considerable assistance in identifying the existence of a state-type structure in northern Iraq, but there is a predominance of individual rule in the region which they simply cannot account for. The formal examination of institutional existence and powers does not give an idea of what actually happens *inside* the institution in question of the political structure as a whole. An idealised, official, version of the activities of the political system is developed, but there is little understanding of the dynamics and processes which occur in reality. Systems analysis is therefore a useful tool to bring out a little known aspect of the Iraqi Kurdish region, but has to be combined with an approach which allows for the analysis of political actors. This combination of different theoretical approaches to the study of political systems is essentially the direction promoted by the neo-institutionalist school of comparative political theory.

The consociational model underlies the analysis of the contemporary political system of Iraqi Kurdistan. With its clearly divided society and political structure, between the factional areas of the KDP and PUK, as well as older tribal and linguistic divisions, a model attempting to analyse the political structures of deeply divided societies, with a prescriptive element for future sustainable political development, obviously has significant potential value.

## **2.5 Field Methodology**

The importance of this thesis, in theoretical as well as practical terms, is that a situation is studied and analysed which has developed through a unique combination of anthropological, historical, geographical and geopolitical factors. The situation of *de facto*-ism is therefore one which is not readily addressed in the literature, and as a result of living and undertaking participatory research in Iraqi Kurdistan for over a year, I feel that I am in a position to discuss this phenomenon in some detail.

There is therefore an opportunity to add to the theoretical literature about such situations but there is also a danger that the stringent application of established theory could cloud the necessary consideration needed to be employed in such a virgin study. It is for this reason why I chose not to follow one particular vein of political theory,



but present an amalgam of ideas from a range of disciplines to be employed in a fluid manner.

Of course, there is a continuum ranging from the dominance of the theoretical approach through to the individualisation of case-studies, where theory is seldom used, and then often inadequately. As stated previously, the weakness of much academic literature focusing on Kurdish politics is precisely the fact that it is often treated as a political-historical case-study, with little attempt to expand the wider bodies of theory. I therefore choose to adopt a position in the study of the Kurds “from the inside” lying somewhat in the midst of this continuum, and intend to focus on the Iraqi Kurdish situation with, as Kohli describes, relevant theoretical approaches, through diverse conceptual lenses, and utilizing a variety of data.<sup>84</sup>

### 2.5.1 Pilot Study

The initial impetus for studying the Iraqi Kurdish political system came after a three-month pilot study period spent in the region, mainly in the cities of Erbil and Suleimaniyah, in the summer of 1997. During this time, I developed close interpersonal links with members of the political parties and the administration. Equipped with the knowledge endowed by my academic training with regard to politics in the Middle East, I identified numerous problems with the portrayal of Iraqi Kurds in the literature.

After numerous discussions with Kurds from a variety of backgrounds, and with observers in the field, it became apparent that there was a huge gap in available knowledge of the characteristics of the KRG, how it works, and how it operates within the political system. Similarly, when in Iraqi Kurdistan, it is apparent that the political party system is hugely complex and Kurdish politics in Iraq has changed remarkably from the late 1970s, the date of the research underwriting the last book of considerable worth in understanding internal political processes of the Kurds, Bruinessen's *Agha, Sheikh and State*.<sup>85</sup>

---

<sup>84</sup> Kohli (1995) “Conclusion” in “The Role of Theory in Comparative Politics: A Symposium,” *World Politics*, Vol. 48, No.1, pp. 1-49, p. 49.

### 2.5.2 Political Parties

The field methodology employed reflects the constantly changing environment of Iraqi Kurdistan. This study has benefited from an amalgamation of a variety of approaches. With regard to the study of political parties, I spent most of 1998 developing very close links with selected cadres of various political parties who were kind enough to entertain my questioning and offered to help in a variety of ways. These links were then developed further during a three-month stay in 1999, and during 2000 when I was present in Iraqi Kurdistan for most of the year. Such an extended amount of time paid dividends as many of the questions I intended to ask had rarely been asked by an academic before, and questions regarding internal political dynamics and power groupings are understandably delicate issues. I then managed to interview party members from different offices and levels of different parties, and was allowed to gather data from the organizations of the KDP in Erbil and the PUK in Suleimaniyah.

An approach I found most useful was to discuss my questions with the highest members of the parties, including Nawshirwan Mustafa, Kosrat Rasoul, Dr Kamal Fu'ad and Jalal Talabani of the PUK, and Sami Abdul Rahman, Hoshyar Zebari, and Massoud Barzani of the KDP, and identify perceptions, directions, and policy initiatives at this level. I would then seek, and obtain, permission to investigate these questions at lower levels in the hierarchy, for example within the *liq* and *melbend* of the KDP and PUK respectively, allowing to get a range of findings, from different levels, and controlled by different issues of relevance allowing me to study one issue from several normative viewpoints.<sup>86</sup>

Perhaps the main methodological problem faced when studying the internal politics of Iraqi Kurdistan is that of bias. Due to the highly politically charged atmosphere, and the potential value of influencing work undertaken for a higher degree, it is understandable that the problem of bias and influencing of judgement was endemic throughout the duration of my fieldwork. This is to be expected and certainly does not detract from the sincerity of those helping me. However, there is no quick solution to

---

<sup>85</sup> Bruinessen (1992a) *Agha, Shaikh and State: The Social and Political Organization of Kurdistan*. London: Zed Books.

<sup>86</sup> For a complete list of interviews undertaken during the period of fieldwork, see Reference List 2.



this problem apart from being able to spend a long enough time in the field, gaining more experience in judging the evidence presented.

### 2.5.3 Kurdistan Regional Government

The study of the administration may seem to be somewhat easier, however, with such a tortured history, and with the KRGs in Erbil and Suleimaniyah doubling each other, the task to investigate their structures, decision-making processes and procedures was a difficult one. I followed a similar set of procedures as I had developed with the political parties, and constructed models, from interviews at many levels, of the governmental decision-making process. Similarly, I assembled a morphological structure of the organs of governance.

To then develop a more targeted understanding of the processes involved, the Ministries of Finance and Economic Affairs in each region allowed me access to their archives in order to assemble documentation regarding the recent implementation of policies and programmes of public service ministries. In conjunction with several General Directors of Planning, I assembled a series of programmes and policies. From these I identified the procedures taken from the initial design of a programme, through to final implementation, and interviewed civil servants from all levels, as well as beneficiaries when appropriate. It is hoped that, by such a methodological approach, my study represents something more than a representative sample, particularly as it benefits from me witnessing the operating of parties and government over a three-year period.

A further important methodological approach which has benefited the research of this thesis may be identified as a form of 'participatory research'. From mid-1999 and throughout 2000, I had the privilege to work closer with the KRG as an adviser in assisting in the establishment of an information-based planning mechanism within the KRGs of Erbil and Suleimaniyah.<sup>87</sup> It was during this period that I came face-to-face

---

<sup>87</sup> The organization of which I was a member, the Iraqi Kurdistan Research Programme, was tasked with promoting the use of statistics within the decision-making process of the KRGs, particularly with regard to the UN oil-for-food deal. Later, the organization was requested by both Prime Ministers (Nechervan Barzani in Erbil and Kosrat Rasoul Ali in Suleimaniyah) to advise on the establishment of a Regional Statistics Office and Planning Organization.

with the Kurdish decision-making process, the relationship between the two administrative areas, and the main dynamics which characterise the system.

#### 2.5.4 Analytical Procedures

The method by which I am choosing to present this wide-ranging data varies considerably. With regard to political parties and organs of governance, I am choosing to employ modelling techniques extensively. Already by employing the notion of the political system, we are referring to a selected part of the real world. A model serves to present this system with a view to simplifying the processes involved within the system in order to enhance comprehension and facilitate predictions.<sup>88</sup>

The typology of modelling procedure employed within this thesis is based upon that formulated by Anderson in his study of the structure and dynamics of US policy making with regard to strategic minerals.<sup>89</sup> My study of Iraqi Kurdistan employs the 3-stage design of morphological, data cascade (information flows), and process-response modelling developed by Anderson as a basis for the study of the Iraqi Kurdish political system.

This approach has at its origin hydrological models of physical geography. Such an application may initially appear to be somewhat out of place, particularly with attempting to apply physical science techniques and methods to more subjective political science. However, by commencing with an approach grounded in a more pure science basis, it is then possible to build modifications addressing the more subjective issues into it, rather than attempting to commence with a subjective type method and making it more scientific – a very difficult task indeed. Furthermore, other academic practitioners have identified the benefits of employing methods and terminologies of the physical sciences, with Krasner applying the geological concepts of punctuated equilibria to the study of institutional change, and Waldner offering a ‘big bang’ approach to the origins of institutions.<sup>90</sup>

---

<sup>88</sup> Anderson (1988) *Strategic Minerals: The Geopolitical Problem for the United States*. New York: Praeger, p. 5.

<sup>89</sup> *Ibid.*

<sup>90</sup> See Krasner (1984) *op. cit.*, pp. 223-246; Waldner (1999) *op. cit.*, p. 19.



However, alterations have been made as, rather than studying a small part of an extremely large system, I am studying virtually the entirety of a small system, which is not particularly open to in-depth research. Therefore, I attempt to provide a morphological model of the major components of the political system. This allows some form of institutional analysis to take place with regard to comparative aspects of political science theories. The second stage I undertook was to investigate how Kurdish politicians and civil servants at a variety of levels perceived their system to work. Finally, I investigated the decision-making process of the system through a range of approaches, all discussed in the relevant sections, but, in brief, ranging from participatory observation, through to programme analysis and interviews.

It should be noted that the entire thesis is inherently difficult to undertake due to Iraqi Kurdistan being somewhat inaccessible, but has been facilitated by my living in the region for a considerable amount of time, carefully developing interpersonal relationships with government officials and party cadres, and witnessing first-hand the operating procedures of the KRG and political parties.<sup>91</sup>

---

<sup>91</sup> Jalal Talabani noted with some disdain that the majority of academics and reporters currently writing about Iraqi Kurdistan have rarely been to the region. In a similar vein, the influential KDP cadre and Acting Prime Minister, Shawkat Sheikh Yazdeen, noted that the weakness of many analyses of Kurdish politics could be traced to the lack of a balanced approach which assesses the many different facets of the Kurdish situation in Iraq. Interviews with Shawkat Sheikh Yazdeen, Erbil, 11 July 2000; Jalal Talabani, Suleimaniyah, 29 August 2000.

## Chapter 3

### Contextual Analysis

#### 3.1 Introduction

An analysis of the political system of Iraqi Kurdistan requires a comprehensive contextual analysis of factors which influence, or have influenced, the region. Located at a crossroads of cultures, nations, states, and political activity at a variety of scales, the list of applicable subjects to address in a contextual analysis of Iraqi Kurdistan would be extensive. For the purposes of this thesis, I am choosing to address those areas which have an immediate impact upon the contemporary political and administrative system, namely the physical and human geographic characteristics of the region, and the economic features which have developed in the 1990s.

#### 3.1.1 Aims and Structure

It is first necessary to develop an understanding of the geography of the region. In a land-locked area such as Iraqi Kurdistan, physical geographical influences and geopolitical considerations are omnipresent within political actions. Aspects of physical geography have been responsible for both negative aspects of Kurdish history, with constituent states coveting the Kurdish regions for natural resources and security of their respective states, and positive aspects, providing the Kurdish people with sanctuary in times of need.

The human geography of the region is addressed with an appraisal of population and political geography. A vital aspect of identity for Kurds is their linguistic characteristics. Often cited as a reason of national unity, but perhaps more an indicator of disunity, the issues surrounding Kurdish dialects are later studied. Similarly, the diversity of religious faiths apparent in the region is a necessary component of the political system to understand, particularly with minority religious and ethnic communities currently enjoying notable political status.

This chapter concludes with an analysis of the Iraqi Kurdish economy. It is apparent that social and tribal relationships promulgated by traditional modes of production



have had a considerable impact upon the development of the contemporary political system. The impact of these economic transformations has resulted in a fundamental alteration of social and tribal relations within Kurdish society. These changes were further compounded by severe upheavals caused by the belligerent attitude of the Iraqi state in the 1980s towards external opponents, and to the Iraqi Kurds themselves. An assessment of the impact upon the economy of the oil-for-food deal (the 986 series of Security Council Resolutions), in effect since 1997, concludes this section.

### 3.2 Geographical Context

Iraqi Kurdistan is a region which suffers from being in an almost constant state of flux and change, in terms of physical geography, as well as in human and economic terms.<sup>1</sup> The influencing of the environment has been perhaps the most effective way of impacting upon the future way of life of Iraqi Kurds, whether by accident or by design. It is therefore of importance in understanding the current predicament of the Iraqi Kurds as it the theatre in which the regional actors perform in and, indeed, impact upon.<sup>2</sup>

#### 3.2.1 Introduction

This section depicts Iraqi Kurdistan and the dynamics and agents of change, such as the *Anfal* campaign, the Iran-Iraq war, the humanitarian aid programme of the 1990s, and how the manipulation of geography has been used as a tool to pursue political ends. The section is divided into three inter-related parts. The physical geography of Iraqi Kurdistan is firstly addressed, as this is the stage on which the Kurdish struggle is performed. To commence with, the territory of Kurdistan in general and Iraqi Kurdistan in particular has to be defined. This is not an easy task since Kurdistan, however defined, has no official boundaries. However, there have been many descriptions of what constitutes Kurdistan, and I will proceed with an overview and analysis of these arguments.

---

<sup>1</sup> The immense deforestation which has occurred in Iraqi Kurdistan is perhaps the most visible example of the changing physical landscape.

<sup>2</sup> For example, the *Anfal* campaign of the late 1980s was a planned way of impacting the lifestyle of Iraqi Kurdistan, by destroying the physical landscape and removing the patterns of human geography

### 3.2.1.1 Defining Kurdistan

“Kurdistan” is impossible to identify as one would identify a recognised state. There are no recognised international boundaries to the territory, and even internal administrative boundaries within states are sometimes controversial and, commonly, ephemeral. This problem is compounded by the normative viewpoints of neighbouring states refusing to acknowledge the existence of a contiguous Kurdish geographical entity, or, in the case of Turkey, to deny the existence of the Kurds as a distinct and discrete people and culture.<sup>3</sup>

Most writers have taken an anthropological approach and describe Kurdistan as being the land or region inhabited by the Kurds.<sup>4</sup> This demographic description allows a territory of Kurdistan to be approximately denoted on maps, but it is open to a great deal of interpretation, particularly as the human geography of the Kurdish people is in flux, with many having migrated from their homeland and intermarriage being a common feature between Kurds and their neighbours. This approach, while being popular, is unfortunately arbitrary in designating the required concentration of Kurds needed amongst the population to qualify the area as being part of Kurdistan. Figure 3.1 depicts the area of Kurdistan according to such demographic descriptions.

### 3.2.1.2 Defining Iraqi Kurdistan

The issue of defining Iraqi Kurdistan became academic after the events of 1991 when a Kurdish controlled area in northern Iraq came into being in the aftermath of the Second Gulf War.<sup>5</sup> For the purposes of this thesis, the Kurdish territory of Iraq includes those areas evacuated by the GOI in 1991, and subsequently controlled by the regional parties and the KRG. This includes the entirety of Dohuk Governorate, most of Erbil Governorate, all of Suleimaniyah Governorate, and a portion of Kirkuk

---

in the area. The effect of UN SCR 986 may not have been planned, but has resulted in a massive change of patterns of living for the population of Iraqi Kurdistan.

<sup>3</sup> Kirisci & Winrow (1997) *The Kurdish Question and Turkey: An Example of a Trans-State Ethnic Conflict*. London: Frank Cass & Co., p. 1.

<sup>4</sup> For example, see Gavan (1958) *Kurdistan: Divided Nation of the Middle East*. London: Lawrence & Wishart, p. 9; Ghassemlou (1965) *Kurdistan and the Kurds*. Publishing House of the Czechoslovak Academy of Sciences, Prague / Collet's Publishers, London, p. 13; Dzeigiel (1981) *Rural Community of Contemporary Iraqi Kurdistan Facing Modernization*. Krakow, p. 9; McDowall (1991) *op. cit.*, p. 8; Bruinessen (1992a) *op. cit.*, p.11.

<sup>5</sup> The First Gulf War was the conflict which took place between Iraq and Iran in the 1980s (1980-1988), also known as the Iran-Iraq War. The Second Gulf War was between Iraq and the Coalition forces which took place upon the invasion of Kuwait by Iraq in 1990.



**Figure 3.1: Kurdistan Identified by Population Distribution**

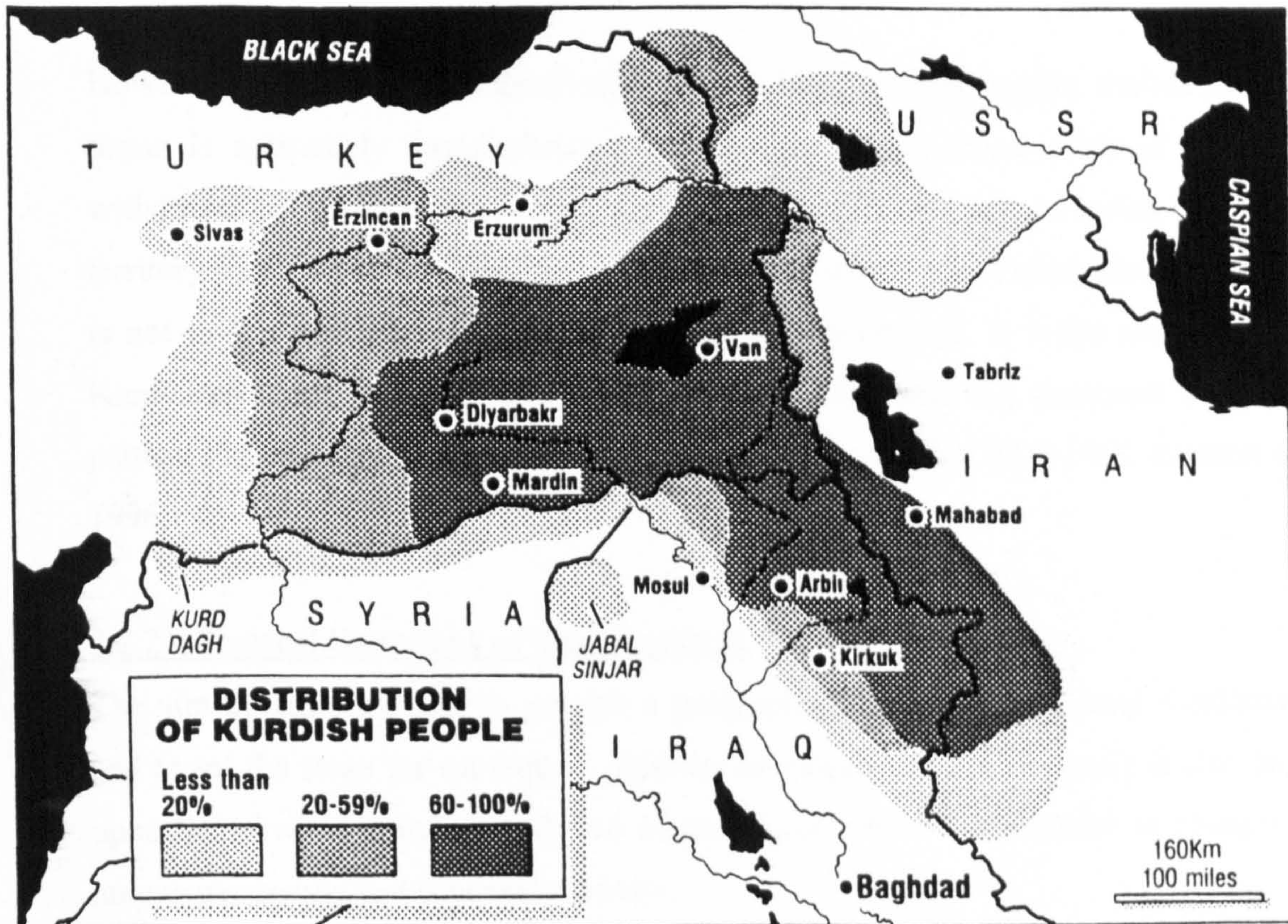

Source: McDowall (1992) *The Kurds: A Nation Denied*. London: Minority Rights Group, p. 10



Governorate. The northern-most limit of the Iraqi Kurdish territory is the border with Turkey and Iran, the western-most limit is the Syrian border, and the eastern boundary is the Iranian border.<sup>6</sup> However, even within Iraq, the area of the Kurdish region is open to debate. Kurdish maps, as illustrated by Figure 3.2, depict Iraqi Kurdistan as covering a significant proportion of Iraq.

However, after 1991, the identification of the Iraqi Kurdish region studied in this thesis is reasonably straightforward and includes those areas north of the line withdrawn to by GOI forces and administration in 1991, and including all Iraqi territory up to the recognised international borders with Syria, Turkey and Iran. This is not to say that this area *is* Iraqi Kurdistan in its entirety, it is the area of Iraqi Kurdistan controlled and administered by the KRG and the dominant political parties. Figure 3.3 illustrates the extent of this region and the KDP-PUK division of 1996.

### 3.2.2 Physical Geography of Iraqi Kurdistan

The aim of this section is to provide a geographical description of Iraqi Kurdistan, and to set the stage for subsequent political developments. An emphasis is also laid upon the environmental degradation of the region which has resulted in changing human geography and economic activity.

#### 3.2.2.1 Topography

From the aspect of physical geography, Kurdistan lies at the mountainous transition belt of the fertile crescent, with the Taurus and Zagros Mountains forming an arc encircling the Mesopotamian region.<sup>7</sup> These mountains have been both home and safeguard of the Kurdish people. Izady notes that;

*“In contiguous Kurdistan, as well as in the many far-flung Kurdish settlements, mountains are the single most important natural phenomenon, and they have shaped the Kurdish history, people, tradition, and culture.”*<sup>8</sup>

---

<sup>6</sup> Legally, the authority of the GOI extends over the whole of the state of Iraq, and covers the Kurdish regions of the north. In practice, however, the KRG, dominated by the KDP in Erbil and Dohuk Governorates and the PUK in Suleimaniyah Governorate and the eastern part of Kirkuk Governorate is the governing authority.

<sup>7</sup> Dziegiel (1981) *op. cit.*, p. 9.

<sup>8</sup> Izady (1992) *op. cit.*, p. 13.











Mountains have therefore become synonymous with the peoples of Kurdistan.<sup>9</sup> This is illustrated by the predominance of mountains in Kurdish folk literature and songs, in their names, and in their affection for the mountainous areas of the country, even if they live in an alluvial plain area such as Erbil, or in the increasingly arid areas of Garmian in Kirkuk.<sup>10</sup>

The mountain chains of Iraqi Kurdistan run in a north-west to south-easterly direction along the border territories with Iran and Turkey. These chains slope to the south to the fertile plains of Harir, Erbil, Sharazur and the Garmian. These plains can be described as being a piedmont zone, coincident with the 30.5cm (12-inch) annual rain line, located between desert-steppe country to the south-west, and the foothills of the Zagros to the north-east.<sup>11</sup>

The foothills of the Zagros rise a few kilometres outside the major urban centres of Dohuk and Erbil, with the city of Suleimaniyah being located within them. Fertile valleys lie between the mountain ridges, and this intermontane zone is heavily dissected with active drainage systems.<sup>12</sup> Braidwood & Howe identify the Kurdish highlands proper as lying beyond the intermontane zone, with an altitude of over 900 metres (3000 feet).<sup>13</sup>

#### 3.2.2.2 Climate

The high mountains of Iraqi Kurdistan are characterised by harsh winters and heavy snowfalls, with precipitation ranging between 400 and 2000 mm. According to the Koeppen system of climate classification, the mountainous areas of Iraqi Kurdistan may be described as being of type D<sub>S</sub>a, which indicates a cool wet climate, continental in nature, with a dry season in the summer. Conversely, the plains and

---

<sup>9</sup> For example, see the descriptions of Arfa (1966) *The Kurds: An Historical and Political Study*. London: Oxford University Press, pp. 1-2; Ciment (1996) *The Kurds: State and Minority in Turkey, Iraq and Iran. Conflict and Crisis in the Post-Cold War World*, New York: Facts on File, pp. 75-76.

<sup>10</sup> Garmian literally means 'warm place' in Sorani Kurdish and refers to those areas which may be classified as semi-arid in the summer months, running south of Taq-Taq in Erbil Governorate, through Kirkuk to Kalar and Kifri.

<sup>11</sup> Braidwood & Howe (1960) *Prehistoric Investigations in Iraqi Kurdistan*. Studies in Ancient Oriental Civilization, No. 31, The Oriental Institute of the University of Chicago. Illinois: University of Chicago Press, p. 13.

<sup>12</sup> *Ibid*, p. 16.

<sup>13</sup> *Ibid*.

valleys of the region enjoy a CSa Mediterranean climate, characterised by rainy winters and dry warm summers with a yearly rainfall of between 200 and 600 mm.<sup>14</sup>

The temperatures within Iraqi Kurdistan vary sharply, from the hot, arid undulating areas of the Garmian, to the bitterly cold high mountain areas in winter.<sup>15</sup> In most parts of the country, the temperature does not normally exceed 35°C.<sup>16</sup> However, the Garmian region south of Darbandikhan commonly exceeds 50°C in the summer months, and it is not unusual for Erbil to attain temperatures of 45°C.

### 3.2.2.3 Rivers, Oil and Natural Resources

Kurdistan is rich in natural resources, and Iraqi Kurdistan in particular is well-endowed with a broad spectrum including water and oil. However, the control of such resources, whether in terms of dams, oil refineries or mines has rarely been in the hands of the Kurds, and has been controlled by the central authorities.

#### 3.2.2.3.1 River Systems

Kurdistan is an oasis in a water-starved region. The abundant rainfall which is common over the Zagros and Taurus mountains has made Kurdistan one of the few watersheds of the Middle East, and home to the source of two of the world's major river systems, the Tigris and Euphrates.<sup>17</sup>

In Iraqi Kurdistan, the major river systems are three main tributaries of the Tigris – the Greater and Lesser Zab, and the Diyala. These three tributaries of the Tigris are all of especial importance to the Kurdish controlled territory of Iraq, and occupy a sentimental part of the mindset of most Kurds. However, none of these 'Kurdish' rivers rise in Iraqi Kurdistan. The Greater Zab rises in Turkey between Lakes Van and Urmia, and the Lesser Zab and Diyala rise in the Iranian Zagros.<sup>18</sup> Favourable geological conditions in Iraqi Kurdistan especially have combined with the abundant

<sup>14</sup> Kliot (1994) *Water Resources and Conflict in the Middle East*. London: Routledge, pp. 104-104; Sajjadi (1992) *op. cit.*, p. 48.

<sup>15</sup> The foothills areas.

<sup>16</sup> Sajjadi (1992) *op. cit.*, p. 48.

<sup>17</sup> Kurdistan Democratic Party (1999) *op. cit.*, pp. 46-52.

<sup>18</sup> Kliot (1994) *op. cit.*, p. 104.



run-off to form an extensive aquifer and spring system.<sup>19</sup> These springs serve as the main source of artificial irrigation and domestic water for the Kurds.

All three of these river systems are of a reasonably large size in terms of mean discharge. Over the 1919-1953 period, the discharge of the Greater Zab was 13.7 billion m<sup>3</sup>, the Lesser Zab 7.65 billion m<sup>3</sup>, and the Diyala 6.16 billion m<sup>3</sup>.<sup>20</sup> However, these systems also display great variability.

These rivers each have had hydro-electric generating installations built on them, however, while the proposed Bekhma Dam on the Greater Zab was almost fully completed, it was never commissioned. The Lesser Zab has been dammed at Dokan in Suleimaniyah Governorate, with the electricity generated here supplying Suleimaniyah and Erbil. The Sirwan-Diyala has been dammed north of Darbandikhan town by the Darbandikhan Dam, with the installation supplying electricity to Kurdish-controlled Kirkuk and Suleimaniyah, as well as to GOI controlled areas. These installations have suffered somewhat under the sanction regime since 1991, but are still operational. Table 3.1 shows the characteristics and capacities of these dams in the period immediately after their completion.

**Table 3.1 Hydro-electric / Irrigation schemes in Iraqi Kurdistan**<sup>21</sup>

	Year of construction	Lake area (km <sup>2</sup> )	Discharge capacity (million m <sup>3</sup> )	Dam		
				Length (m)	Height (m)	Discharge capacity (m <sup>3</sup> per second)
Darbandikhan	1961	120	3.0	535	128	11,400
Dokan	1959	270	6.8	360	116.5	4,600

<sup>19</sup> Izady (1992) *op. cit.*, p. 224.

<sup>20</sup> *Ibid*, p 107.

<sup>21</sup> Ockerman & Samano (1985) "The Agricultural Development of Iraq," in Beaumont & McLachlan (eds.), *Agricultural Development in the Middle East*. London: Wiley and Sons, p. 196, quoting Ministry of Culture and Information (GOI) figures (1980) and Planning and Follow-up Department (GOI) figures, 1981; Kliot (1994) *op. cit.*, p. 121.

It should be noted that the establishment of such large water bodies was achieved at the expense of Kurdish landholders and farmland in the valleys affected by these programmes, in a similar way as to how the Southeast Anatolian Project (GAP) is affecting Turkish Kurdish farmers. Izady explains that:

*“Due to the extraordinary archaeological richness of the land, almost any dam built in Kurdistan drowns a portion of Kurdish history . . . . one can only guess the magnitude of the loss of the historical remains in sites like the Darbandi Khan [Darbandikhan] Dam near Halabja, the very heartland of Kurdistan.”<sup>22</sup>*

#### 3.2.2.3.2 *Petroleum Resources*

Oil is found in abundance in the rock strata of the parts of Iraqi Kurdistan administered by the GOI. With approximately 45 billion barrels of oil, this area has among the largest oil reserves in the Middle East, and contains larger proven deposits than the US.<sup>23</sup> However, while the land of Kurdistan is undoubtedly well-endowed with petroleum riches, the peoples of Kurdistan have never directly benefited from the exploitation of the resource, and have only received its benefits indirectly from the GOI.

Within the area governed by the Iraqi Kurds since 1991, there are a number of oil deposits which are potentially economically viable. In the environs of Taq-Taq, there are three wells capable of producing a total of 15,000 barrels a day. However, these were filled with concrete by the GOI army. Other reserves within the Kurdish-controlled territory are found at Qoratu, near Kalar, and Tawog near Zakho. It is estimated that Tawog is capable of producing 2,000 barrels per day, and Qurato 10,000 barrels per day.<sup>24</sup>

#### 3.2.2.4 Conclusion

The northern regions of Iraq are indeed well-endowed with natural resources, and in particular oil and water. However, the Kurdish-controlled region of Iraqi Kurdistan does not benefit directly from the abundant oil resources due to the means of production being located in territory controlled by the GOI. Furthermore, whilst the

<sup>22</sup> Izady (1992) *op. cit.*, p. 226.

<sup>23</sup> *Ibid.*, p. 221; Kurdistan Democratic Party (1999) *op. cit.*, pp. 54-56.



major river systems of Iraq are supplied by tributaries which rise in the Kurdish-controlled regions, and two major dams also exist in the area (Dokan and Darbandikhan), the political system of Iraqi Kurdistan has recently been dominated by water-geopolitics, with the GOI threatening to invade the Kurdish regions in order to control the dams during times of drought. Whilst the Kurds may enjoy control of the means of storage and distribution, they are rarely free to exercise their authority over its usage.<sup>25</sup>

### 3.2.3 Human Geography

As the aim of this thesis is to examine the political system of Iraqi Kurdistan, it is necessary to address the subject of human geography with an approach grounded in political geography. The importance of understanding the political geography of Iraqi Kurdistan becomes especially apparent when the geographical and geopolitical situation of the region is fully appreciated. Situated in one of the most volatile parts of a most volatile region (the Middle East), surrounded by states, dependent throughout history on the characteristics of the physical geography of the Kurdistan region for their survival as a discrete body of people, the understanding of this region's political geography in a purely contextual manner is an essential exercise to undertake before the complexities of the Iraqi Kurdish political system can be fully addressed.

#### 3.2.3.1 Population Geography

Population statistics for Kurdistan proper are notoriously variable. The constituent states of Kurdistan are tempted to minimize the figure in an attempt to play down the importance of the Kurdish minority within their country, whereas Kurdish nationalists and the political parties are prone to exaggerate the number. Table 3.2 presents a summary of estimates available in the literature.

It is important to note the rise in estimates throughout the period, even taking into account such atrocities as the *Anfal* campaign, and Arabization and Turkification

---

<sup>24</sup> Keen (1993) *The Kurds in Iraq - How Safe is their Haven Now?* London: Save the Children Fund, p. 67.

<sup>25</sup> The GOI came close to invading Suleimaniyah on 9 June 2000 over the issue of water discharge from the Dokan and Darbandikhan dams during the drought which afflicted Iraq in the summer of

policies. As well as witnessing an exodus of people from the region, there has been an influx in as well. Kurds have been returning from Iran throughout the 1990s where they have been since the Kurdish retreat in 1975.<sup>26</sup> The Kurds and Turkmen of Kirkuk have also been suffering under attempts by the GOI to arabize the city, and have been expelled into Kurdish controlled areas.<sup>27</sup>

**Table 3.2: Estimates of the Kurdish Population<sup>28</sup>**

Author:	Ghassemlou (1965) <sup>29</sup>	Short & McDermott (1977) <sup>30</sup>	Bruinessen (1978) <sup>31</sup>	More (1984) <sup>32</sup>	McDowall (1992) <sup>33</sup>
Country					
Turkey	4,900,000 (18)	5,600,000	7,500,000 (19)	10,000,000 (24)	10,800,000 (19)
Iraq	3,300,000 (22)	3,400,000	2,500,000 (23)	3,000,000 (27)	4,100,000 (23)
Iran	1,550,000 (16)	2,025,000	3,500,000 (10)	6,000,000 (16)	5,500,000 (10)
Syria	400,000 (10)		500,000 (8.5)	800,000 (9)	1,000,000 (8)
Other	259,000	165,000	100,000	---	1,200,000
<b>Total</b>	<b>10,409,000</b>	<b>11,630,000</b>	<b>14,100,000</b>	<b>19,800,000</b>	<b>22,600,000</b>

2000. The result saw Talabani ordering the opening of the dams for long periods every day throughout the summer.

<sup>26</sup> See Chapter 4.

<sup>27</sup> These people are not classed as refugees by UNHCR as they have not been forced out of the country. They are therefore known, in UN parlance, as Internally Displaced Peoples (IDPs).

<sup>28</sup> Figures in brackets indicate the percentage of the population of the named country who are Kurdish. For example, *Syria* 400,000 (10) indicates that there are an estimated 400,000 Kurds in Syria, constituting 10 percent of the total population of Syria.

<sup>29</sup> Ghassemlou (1965) *op. cit.*, pp. 21-23. Ghassemlou is precise in his descriptions of who is included in his figures. The totals presented here are the ones Ghassemlou arrived at for estimating the number of Kurds in the whole of the country, and not just in Kurdistan.

<sup>30</sup> Developed from Short & McDermott (1977) *The Kurds*. London: Minority Rights Group, p.5. The figures presented here are not strictly those of Short & McDermott. In their report, they quite rightly emphasise the unreliability of population statistics related to Kurds, and therefore provide a maximum and minimum figure. The figure presented here is the average of the two.

<sup>31</sup> Bruinessen (1992) *op. cit.*, pp. 14-15. Bruinessen's objective population estimates date from 1975 and were subsequently published in his 1978 doctoral thesis. This, in turn, was published as the 1992 reference.

<sup>32</sup> More (1984) *Les Kurdes Aujourd'hui: Mouvement National et Partis Politiques*. Paris: Editions L'Harmattan, p. 21. More presents the figures as percentages of the total population of the constituent country. The above figures were therefore calculated from More's percentages and appeared in Aguado (1990) "The National Liberation Movement of the Kurds in the Middle East," in Premdas, Samarasinghe & Anderson, (eds.), *Secessionist Movements in Comparative Perspective*. International Centre for Ethnic Studies; London: Pinter Press, p. 155.

<sup>33</sup> McDowall (1992a) *The Kurds: A Nation Denied*. London: Minority Rights Group, p. 12. McDowall chose to base his figures on the 1978 ones of Bruinessen, and apply his Kurdish population



Within Iraqi Kurdistan, population estimates are further compounded because there has been much population movement within the territory, and away from it. To some extent, this problem in Iraqi Kurdistan should have been alleviated by the influx of humanitarian aid agencies following the Second Gulf War. These agencies conducted large surveys, and the World Food Programme (WFP) is responsible for distributing a food ration to every person in the territory. However, surprisingly, there is still no consensus among the large agencies as to the total population of Iraqi Kurdistan. Table 3.3 illustrates the variety of figures available for Iraqi Kurdistan and are the results of various surveys which have been carried out in Iraqi Kurdistan, normally by a department of the KRG and a UN agency or international NGO.

**Table 3.3: Population Estimates, By Governorate**

Department / Agency (and year of survey)		DRD (1996) <sup>34</sup>	WFP (1996) <sup>35</sup>	CES (1996) <sup>36</sup>	DRD/DWS (1995) <sup>37</sup>
Governorate	Dohuk	747,334	783,865	691,914	755,378
	Erbil	1,054,567	1,141,505	1,011,748	1,120,765
	Suleimaniyah	1,194,099	1,026,322	1,055,154	1,529,406 <sup>38</sup>
	Darbandikhan	335,307	363,512	332,550	---
<b>Total</b>		<b>3,331,301</b>	<b>3,315,204</b>	<b>3,091,367</b>	<b>3,405,549</b>

#### 3.2.3.1.1 *Population Distribution*

It is a difficult task to ascertain the population of the urban areas as they are constantly expanding and contracting, depending on the influx of peoples from the rural areas of the region seeking economic benefit by coming to the cities, or by internally displaced peoples coming from GOI controlled Kurdish territory..

percentages to national statistics in the early 1990s. However, this does assume that Kurdish demography is similar to the demography of the neighbouring states.

<sup>34</sup> Department of Rural Development (Ministry of Reconstruction and Development, KRG) figures, 1996 survey.

<sup>35</sup> WFP / General Directorate of Food Trade (Ministry of Finance and Economic Affairs, KRG) figures, 1996 survey.

<sup>36</sup> Compulsory Education Survey, Ministry of Education – UNICEF (KRG), 1996.

<sup>37</sup> Department of Rural Development / Department of Water and Sanitation (Ministry of Reconstruction and Development, Ministry of Municipalities and Tourism, KRG), 1995.

The figures of Table 3.4 have been developed from surveys undertaken by the KRG, UN agencies and NGOs. The exactness of the presented figures is problematic, and as with all population surveys, suffers from a high degree of ambiguity. However, even accepting the weaknesses of the absolute figures, the breakdown does offer useful information regarding population distribution. The figures suggest that current ratio between rural and urban areas in Iraqi Kurdistan is approximately 3:1 (including collective settlements as urban). This fact illustrates the mass movement which has, and still is, taking place from the rural areas into the swollen towns and cities. In addition, these figures do not take fully into account the influx of internally displaced peoples into the urban centres of Iraqi Kurdistan, which may force the ratio even higher.

**Table 3.4: Rural – Urban Population Breakdown, All Governorates**<sup>39</sup>

	<i>Total Population</i>	<i>Rural</i>		<i>Urban</i>		
				<i>Collective</i>		<i>City/Town</i>
		<i>Population</i>	<i>%&lt;5</i>	<i>Population</i>	<i>%&lt;5</i>	<i>Population</i>
<b>Dohuk</b>	783,865	217,670	18	194,153	18	372,042
<b>Erbil</b>	1,141,505	237,675	17	177,818	23	726,012
<b>Suleimaniyah</b>	1,026,322	265,921	16	308,416 <sup>40</sup>	17	716,688 <sup>41</sup>
<b>Darbandikhan</b>	363,512	98,809	16			
<b>Total</b>	<b>3,315,204</b>	<b>820,075</b>	<b>17</b>	<b>680,387</b>	<b>19</b>	<b>1,814,742</b>

### 3.2.3.2 Administrative Divisions of Iraqi Kurdistan

The administrative organization of Iraqi Kurdistan is prescribed by the GOI's Governorate Law of 1969 (as illustrated by Figure 3.4).<sup>42</sup> Iraq as a whole is divided

<sup>38</sup> Includes figures for Darbandikhan Governorate.

<sup>39</sup> Total population figures from WFP / Department of Food (Kurdistan Regional Government Ministry of Finance and Economic Affairs) Northern Iraq database (1996), calculated from food agents reports on the Oil-for-food Programme. Rural population figures from Ministry of Reconstruction and Development (Erbil) / Directorate of Reconstruction (Suleimaniyah), Village Survey 1997. Collective figures from Durham University Collective Settlement Survey, 1998. City/town figures calculated by combining all sources.

<sup>40</sup> Includes figures for Darbandikhan Governorate.

<sup>41</sup> *Ibid.*



into governorates of varying size. These governorates are sometimes related to the districts, or *vilayets* of the Ottoman Empire, and some are new constructs, representing changes in population. Before 1991, in the north of the country, four governorates were home to a considerable Kurdish presence. These were the Governorates of Dohuk, Erbil, Suleimaniyah and Kirkuk.

This situation was subsequently confused by the withdrawal of the GOI from parts of this territory in October 1991. The withdrawal did not take place along neat lines of governorate administrative areas. The Governorate of Erbil lost the area south of Qushtapa and Taq-Taq, and the Governorate of Kirkuk was left mainly under the authority of the GOI, including the oil-city of Kirkuk and the important Kurdish town of Tuz Khurmuta. The area known as Garmian, centred on the town of Darbandikhan and including Kalar and Kifri to the south, was left in the hands of the Kurdish forces.<sup>43</sup>

The boundaries of two of the four Kurdish dominated governorates of Iraq were therefore substantially altered. This resulted in an interesting battle of labelling between the Kurds and the GOI. The Kurds kept the names for Erbil, Dohuk and Suleimaniyah Governorates. This was an acceptable move by all parties and organizations as the vast majority of the Governorate of Erbil was still left in the control of the Kurds. However, the GOI established an alternate centre for the Governorate of Erbil under their control, centred on the town of Makhmour. There are therefore two Erbil Governorates existing side-by-side, separated by the dividing line between the GOI and the KRG.<sup>44</sup>

The situation was slightly different in the Governorate of Kirkuk, as the centre of administration, Kirkuk, was not under the control of the Kurds. However, Kirkuk

---

<sup>42</sup> Government of Iraq (1969) Governorate Law (*Al-waqai'a al-'iraqya qaanun al-muhafadhat*).

<sup>43</sup> Garmian is not an official area, but designates a swathe of land which roughly starts at Darbandikhan and stretches down to Khanaqin in the south, Chamchamal to the west, and the Iranian border towns to the east.

<sup>44</sup> This is an important fact to highlight and will be developed in the forthcoming chapters. Although the KRGs in Erbil and Suleimaniyah have a Defence Ministry in the form of Ministries of *Peshmerga* Affairs, the KRG does not have its own army and the political parties have kept their own separate party *peshmerga*.

**Figure 3.4: Administrative Sub-Divisions, 1999<sup>45</sup>**

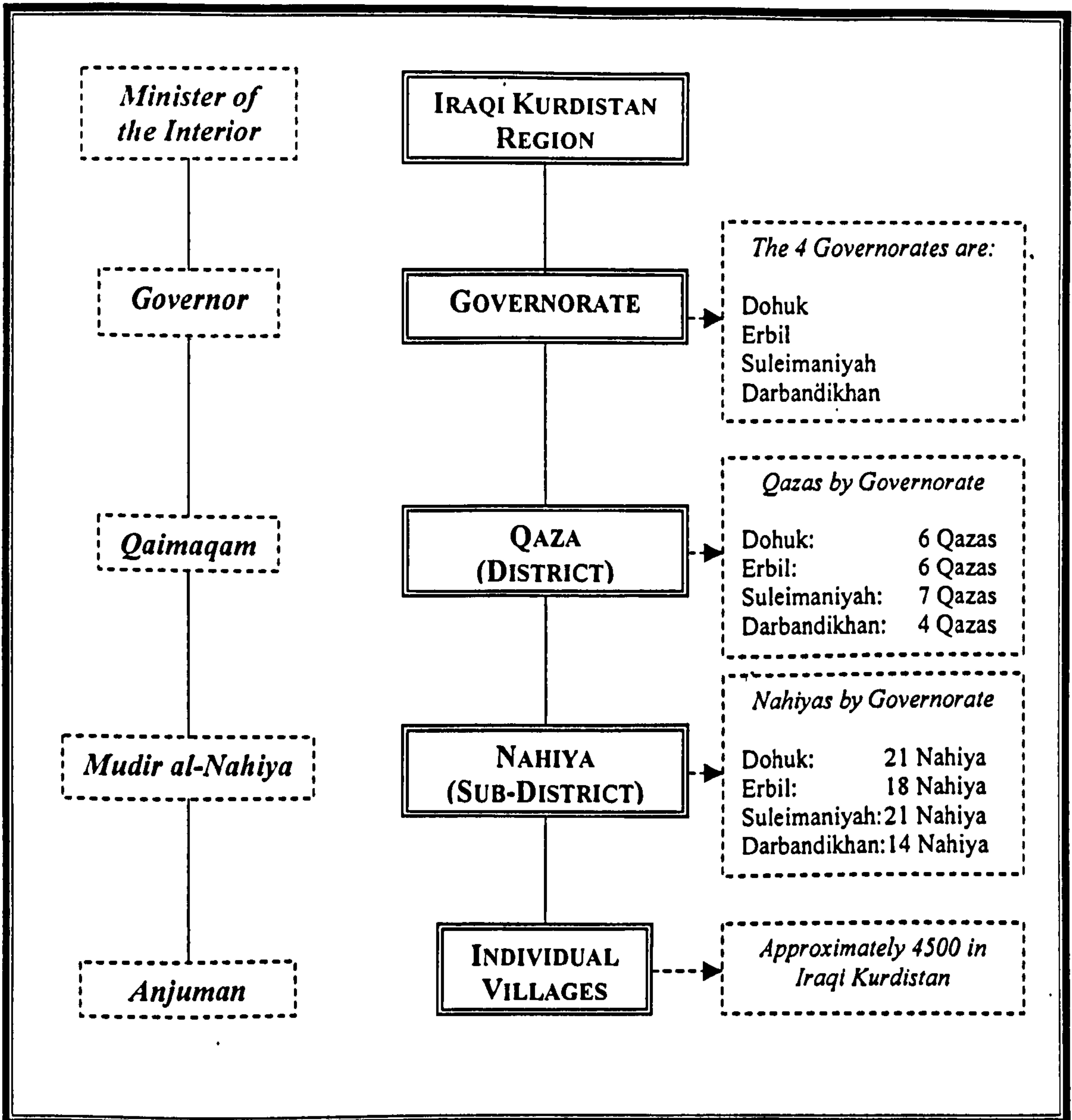

occupies an almost mystical position in the Kurdish psyche, and it was an important point for them to emphasise that at least part of Kirkuk Governorate was under their control. Even though the centre of administration for the remaining Kurdish controlled territory became the small town of Darbandikhan, the territory was still known by the Kurds as the Governorate of Kirkuk (or New Kirkuk), much to the

<sup>45</sup> Sources: Kurdistan National Assembly (1994) *Ademocrattiyya Aparliamen wa Hukumat fi Junub Kurdistan*, (Parliamentary Democracy and Governance in Southern Kurdistan): Erbil, Iraqi Kurdistan; interviews with Aso Sheikh Nuri, Suleimaniyah, 5 May 1998; Mahdi Khoshnaw, Erbil, 14 June 1998; for information regarding the governorate structure of Iraq, see the Iraqi Governorate Law of 1969; village numbers obtained from Durham University Iraqi Kurdistan Humanitarian Assistance Policy Planning Unit database.



annoyance of the GOI. However, for the purposes of clarity, I will refer to this governorate as Darbandikhan, following the logic of the names of the other governorates of Iraqi Kurdistan as carrying the name of the principle town under the control of the Kurds. It also acts to resolve confusion over which Governorate of Kirkuk is being discussed.

A similar problem arose between the Governorates of Erbil and Suleimaniyah in 1996 after the internecine fighting between the PUK and KDP, which commenced when the KDP captured Erbil City, with the assistance of the forces of the GOI, on the 31 August 1996. The result of the subsequent fighting was that the KDP retook Erbil City, and most of the Governorate of Erbil, while the PUK controlled the Governorate of Suleimaniyah, and a small part of eastern Erbil Governorate centred on the town of Koysinjaq, and part of Kirkuk Governorate centred on the town of Darbandikhan. The PUK dominated administration of the KRG based in Suleimaniyah named this region the Governorate of Erbil, and established a governorate structure centred on the town of Koysinjaq. For the purposes of this thesis, I will refer to this area as PUK administered Erbil, with the other administrative areas being the Governorates of Erbil, Dohuk, Suleimaniyah and Darbandikhan.

#### 3.2.3.2.1 *The Administrative Sub-Divisions of Iraqi Kurdistan*

Kurdish-controlled Iraqi Kurdistan is sub-divided into administrative units according to the 1969 law, as shown by Figure 3.5. The governorate is divided into smaller administrative divisions, individually named as qaza. They are of varying size and are equivalent to a British district or American county. The Governorates of Dohuk and Erbil are divided into six qaza each, Suleimaniyah is divided into seven, and Darbandikhan is divided into four. The head of the qaza, the representative of the Governor, is called the Qaimaqamiyat, and has the power of Governor within his qaza. The smallest administrative sub-division used in Iraq is the nahiya. This division translates into sub-district, and again is of varying size. Again, nahiyas have an urban core, which is normally an established small town, although some are Collective towns established in the 1980s. The chief executive of the nahiya is the mudir al-nahiya.

**Figure 3.5: The Governorates, Qaza, and Nahiya of Iraqi Kurdistan, 1999**

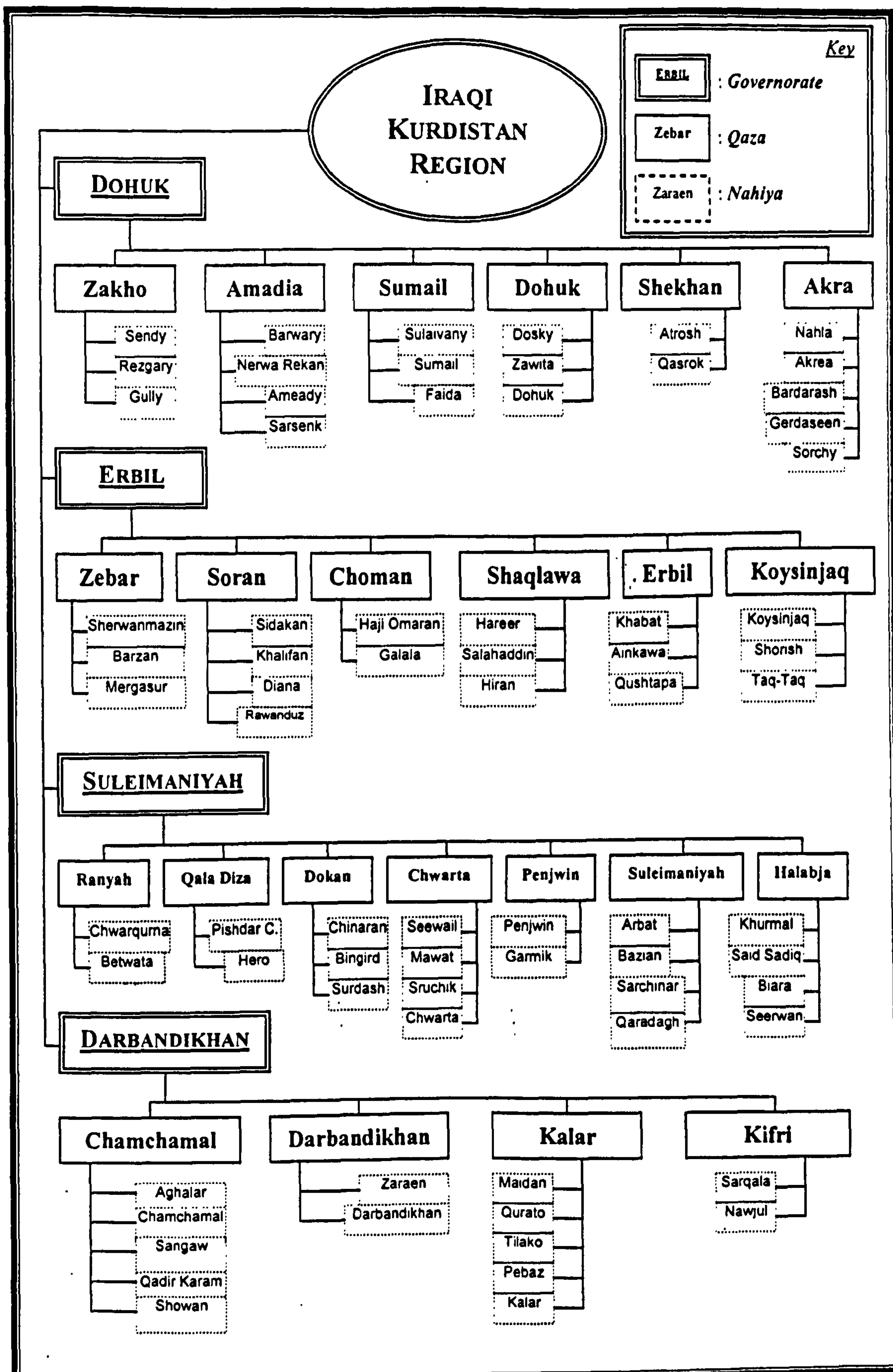



### 3.2.4 Conclusion

The geography of Iraqi Kurdistan has been forced into unnatural changes, which may be described as being the result of political actions altering the physical or human geography of the region, whether by accident or design. The physical environment has undergone tremendous deforestation and defoliation especially since 1975, and then through the 1980s with the Algiers Agreement and subsequent *Anfal* Campaigns of the GOI. Today, where the mountainous areas should be thickly wooded, they are bare and suffer from severe soil denudation and erosion, effecting the long-term fertility of the land. The climate has also suffered from the effects of exposure and lack of micro-climate regulation.

These physical changes have affected the human geography. The rural population was forced from these areas into the increasingly sprawling cities, firstly due to political pressure from the GOI, then due to the destruction of the environment, and lastly, and perhaps most tragically, due to the lack of a market created by the oil-for-food deal.<sup>46</sup> Furthermore, the agricultural producing land of the mountains is dependent upon specific local farming knowledge which, if lost for just one generation, could be lost forever. This problem is further discussed in the economic section.

The human situation is increasingly tragic. Cities, such as Erbil, which have grown naturally to a size of little more than 400,000 people, are now sprawling masses which may soon be in excess of 1,000,000 people. Suleimaniyah and Dohuk have suffered similarly under these pressures, as have most other urban centres. This has created immense human hardship and poverty for some people, and opportunities for economic, or even human, exploitation for others, resulting in societal problems previously unheard of in the region. With cheap labour readily available there are now no problems for unscrupulous employees to decrease wages. Similarly, there are no problems with increasing rents on inadequate housing. Once unheard of, prostitution is now rising, and the streets of the major cities and urban areas are home to an ever-growing number of street children.

---

<sup>46</sup> See Section 3 of this chapter.

Such a social environment is unstable. In political terms, this instability has manifested into a proliferation of small radical parties, the increase of *peshmerga* for the major parties as they pay a guaranteed salary, and by the rise of the Islamist parties benefiting from a wave of younger peoples increasingly disillusioned with attempting to improve their material status and turning to more spiritual lifestyles. Islamist parties have also become popular due to the humanitarian activities undertaken by certain NGOs under the banner of Islam.

The unstable geography of the region, stemming mainly from political actions and having both physical and human manifestations, is one of the most important factor for any administration or political party charged with running Iraqi Kurdistan to deal with in the immediate future. Such an approach would have to address the population distribution, and institute economic and infrastructural incentives for the rural population to return to their ancestral lands, and for the appalling conditions in the major cities to be targeted. Without such an approach, the impact of the policies of any regional administrative body can only ever be short term and temporary.

### 3.3 Language

The degree of a shared language has long been identified as a key indicator of the development of an ethnic consciousness and ethnonationalism.<sup>47</sup> However, while virtually all exponents of Kurdish-ness argue that Kurdish is a distinct language and is used as the common means of communication in Kurdistan, and particularly in Iraqi Kurdistan, the importance of the Kurdish language in fostering a feeling of nationalism is debatable as, unlike their Arab, Turkish and Persian neighbours, the Kurds have not yet evolved a single systematized written or spoken standard. The varied span of Kurdish dialects may also be an indicator of the varied origins of the Kurdish peoples, and it is interesting to note that, within Iraqi Kurdistan, linguistic divisions are often reflected in the spoken dialect of choice.<sup>48</sup> It is an unfortunate reality that the Kurdish language has often been an indicator of divergence rather than political unity.

---

<sup>47</sup> Entessar (1992) *op. cit.*, pp. 4-5.

<sup>48</sup> The KDP, for example, are often referred to as the Bahdinanis as the stronghold of KDP support is in the Bahdinan speaking region of Iraqi Kurdistan.



### 3.3.1 The Kurdish Dialects

The language spoken by most of the population of Iraqi Kurdistan is Kurdish. However, "Kurdish" has many constituent dialects which are closely linked to Persian, but incomprehensible to Turks and Arabs. Kurds of different dialectic groupings cannot communicate easily with other Kurds in their mother tongue, somewhat weakening the positive attributes of a shared language.<sup>49</sup> The Bahdinani "Kurdish" of Zakho, for example, is quite different to the Hawrami "Kurdish" of Tawela.<sup>50</sup> The Kurdish group of languages belongs to the north-western or south-western subdivision of Iranian languages<sup>51</sup> and can be broken down into four major subdivisions:<sup>52</sup>

1. The northern and north-western dialects, usually called Kurmanji. This dialect is spoken in Turkey, and the northernmost parts of Iraqi and Persian Kurdistan. In Iraqi Kurdistan it is referred to as Bahdinani.<sup>53</sup>
2. The southern dialects, often called Sorani, but is in fact a grouping of many dialects from this area. Sorani is commonly considered to be the classical Kurdish of Iraqi Kurdistan. This dialect is spoken in southern Kurdistan, including most of Iraqi Kurdistan.
3. The south-eastern dialects such as Sanandaji, Kermanshahi and Leki. These dialects are closer to modern Persian than the previous two groups.
4. The dialects of Zaza and Gurani. Zaza is spoken in north-western Kurdistan (north and west of Diyarbakir in Turkey), and Gurani is spoken in various parts of southern Kurdistan.<sup>54</sup>

---

<sup>49</sup> Cook (1995) *The Safe Haven in Northern Iraq: International Responsibility for Iraqi Kurdistan*. London: Human Rights Centre and University of Essex, p. 7. Ironically, when conducting surveys for humanitarian aid agencies in 1998, the author found it easier and more efficient to use Arabic. Virtually all the surveyors, whether from Bahdinan or Soran, understood Arabic, and it proved to be less confusing than having to handle two separate surveying systems. When put in the same room for undergoing survey training, Kurds from Dohuk and Erbil would commonly communicate in Arabic rather than attempting to use the Kurdish dialect of the other.

<sup>50</sup> Zakho is a major town in Dohuk Governorate, on the border with Turkey. Tawella is a small trading town in Halabja Qaza of Suleimaniyah Governorate, lying on the Iranian border.

<sup>51</sup> It used to be commonly accepted that Kurdish is a north-western Iranian language. MacKenzie however challenged this idea and showed that Kurdish may in fact have more in common with the south-western Iranian languages (Mackenzie (1961) "The Origins of Kurdish." *Transactions of the Philological Society*, pp. 68-86. Quoted in Bruinessen (1992a) *op. cit.*, p. 47).

<sup>52</sup> These divisions are based upon those of Bruinessen (1992a) *op. cit.*, pp. 21-22.

<sup>53</sup> Dzeigiel (1981) *op. cit.*, p. 17.

<sup>54</sup> Bruinessen (1992b) *op. cit.*, p. 3.

These dialectic groupings are not mutually exclusive and merge into each other. This is particularly apparent in the late 1990s as there is increased rural to urban migration the presence of Kurdish refugees from Kirkuk, the expulsion of Kurds from the major urban centres of Iraqi Kurdistan by the KDP and PUK to the territory of the opposing party, and the return of Iraqi Kurdish refugees from Iran.

### 3.3.1.1 Lexical Systems

The lexical systems of these dialects display notable divergence due to Kurdistan being divided between different nation-states. Kurmanji and Zaza are written in Latin script in Turkey. This situation developed after the Turkification policies of Mustafa Kemal Ataturk banned the Arabic script as the writing system of Turkish. The subsequent teaching of this script throughout schools in Turkey, including south-east Anatolia where the Turkish Kurds originate, guaranteed that Latin script would become the standardised script for both Turkish, and for the illegally spoken Kurmanji and Zaza. Similarly, the arabisation policies of the governments of Iraq and Syria, and the natural osmosis of linguistic characteristics, resulted in the Kurds of these countries writing and reading their language in a modified Arabic script. This is also the case with the Kurds of Iran. The script is commonly referred to as Arabic script, but has additional characters alongside those regularly found. Kurds who reside in Armenia and Azerbaijan, in effect the ex-USSR, use the cyrillic script.

### 3.3.2 Iraqi Kurdish Dialects

These dialect groups show considerable lexical and phonological differences, and also differ significantly in some grammatical features, such as the treatment of past tenses and transitory verbs. However, the language has survived both as a common means of spoken and written communication, as a medium of teaching in schools and universities in Iraqi Kurdistan, and as a language with a written literary tradition, dominated by the Sorani dialect.<sup>55</sup>



### 3.3.2.1 Bahdinani and Sorani

In Iraqi Kurdistan, the Kurds of Dohuk Governorate and the mountainous regions north of Erbil City speak Bahdinani Kurdish<sup>56</sup>, whereas those of the rest of Erbil, Suleimaniyah and Darbandikhan Governorates predominantly speak *Sorani* Kurdish.<sup>57</sup> There is also a small but significant grouping of *Hawrami* Kurdish speaking peoples who reside in the mountainous regions between Iraq and Iran, and are concentrated in the areas east and north of Halabja.<sup>58</sup>

Ghassemlou postulates that the dominance of the Sorani dialect in Iraqi Kurdistan may be traced to the prevalence of the dialect in Kurdish literature which took place during the existence of the Mahabad Republic in Iran between 1945 and 1946. Following the revolution of 14 July 1958 in Iraq, Kurdish literature began to develop at great speed because of the acknowledgement of Kurds in the Constitution. Sorani Kurdish therefore assumed a position of being the chief dialect of Kurdish literature, and the dialect taught in Kurdish schools in Iraq.<sup>59</sup>

McDowall estimates that, grammatically, the Bahdinani and Sorani dialects differ from each other as much as English and German, although vocabulary differences are probably of the same order as those between Dutch and German<sup>60</sup>, however, Ghassemlou contradicts this by saying;

*“ . . . there is no substantial difference between these two dialects [Bahdinani and Sorani]; basically, they form a single language: they have a similar word stock and the same grammatical structure. It must be noted that in spite of certain differences between Kurdi [Sorani] and Kermanji [Bahdinani], it is quite easy for the Kurds from*

---

<sup>55</sup> Nikitine (1958) *Les Kurdes, Etude Sociologique et Historique*. Paris: Imprimerie Nationale, quoted in Ghassemlou (1965) *op. cit.*, p. 27.

<sup>56</sup> The Bahdinani dialect is more commonly known as Kurmanji in the academic literature. This dialect is spoken northwards for Mosul, through Turkey, and into Armenia and Azerbaijan. In Iraqi Kurdistan, Kurmanji is prevalent in the Iraq - Turkey border areas, Dohuk Governorate, Zakho, and the north-western areas of Erbil Governorate, and is known as Bahdinani due to this area being historically named Bahdinan by Iraqi Kurds. It is important to note that Bahdinani is the dialect spoken by the Barzani family.

<sup>57</sup> The Sorani dialect is spoken across most of Iraqi Kurdistan, and in Iraq was the official Kurdish, indicating the cultural pre-eminence of Suleimaniyah over other Iraqi Kurdish centres. The Sorani dialect is commonly used by the PUK.

<sup>58</sup> For further information on Kurdish dialects, see McDowall (1996a) *A Modern History of the Kurds*. London: I.B. Taurus. Hawrami is more commonly known as Gurani in the academic literature. However, within Iraqi Kurdistan it is known as Hawrami after the geographical area of Hawraman.

<sup>59</sup> Ghassemlou (1965) *op. cit.*, p. 27.

<sup>60</sup> McDowall (1996a) *op. cit.*, p. 9.

*the north-western and south-eastern areas to understand one another.*<sup>61</sup>

After spending 3 years in Kurdish-controlled Iraqi Kurdistan, it is my opinion that the difference between Bahdinani Kurdish and Sorani Kurdish lies somewhere between the views of McDowall and Ghassemlou.

### 3.3.3 Conclusion

As Iraqi Kurdistan is essentially home to a linguistic fault-line between the two major Kurdish dialects, the notion of a shared language promoting a unified sense of ethnonationalism may be weakened somewhat, and with it the idea of a shared ethnic consciousness. The division between the two dialects is commonly referred to as being the Great Zab River, which is now the administrative boundary between the governorates of Dohuk and Erbil. It is readily apparent that Sorani is dominant in the cities of Erbil and Suleimaniyah, and Bahdinani similarly so in Dohuk. While exact ratios of speakers of Bahdinani to Sorani are difficult to ascertain, it is likely that Sorani is the spoken dialect of the majority of Iraqi Kurds.

Furthermore, there are other languages used in Iraqi Kurdistan, and, in localised areas of minority populations, are the languages of common usage. The Christian communities of Assyrians, Chaldeans and Nestorians speak Aramaic, and the Turkomen population speaks a Turkic dialect.

## 3.4 Religion and Minorities

The overwhelming majority of Kurds are Muslim. Entessar states that at least two-thirds follow the Shafa'i school of Sunni jurisprudence, Bruinessen estimates the percentage of Kurds who are Sunnis to be 80%, and McDowall suggests a higher figure with 85%.<sup>62</sup> There are major concentrations of Kurds following Shi'a Islam in the Kermanshah region of Iran and in the Khanaqin district of Iraqi Kurdistan.<sup>63</sup> There are also pockets of various Sufi orders of the Naqishbandi, the Qadiri and some Ali-Allahis (Ahl-i Haqq).<sup>64</sup> Even though the vast majority of Kurds are

<sup>61</sup> Ghassemlou (1965) *op. cit.*; pp. 27-28, quoting *Sovremennii Iran*, Moscow, 1957.

<sup>62</sup> See McDowall (1991) "The Kurds: An Historical Perspective," *Asian Affairs*, Vol. 22, No. 3, pp. 293-302, p. 6; Bruinessen (1992b) *op. cit.*, p. 4; Entessar (1992) *op. cit.*, p. 5.

<sup>63</sup> Entessar (1992) *op. cit.*, p.5.

<sup>64</sup> *Ibid.*



Muslims, religion is not a truly uniting factor of Kurds in Kurdistan. Kurds have accepted Islam with piousness and devotion to duty, but in a highly personal manner, with little thought given to Islam in a political or socially unifying sense.<sup>65</sup> Furthermore, there are numerous religions practiced by other minorities in Kurdistan, which, interestingly, are factors in uniting non-Kurds in Kurdistan, an opposite situation as to that of the Kurds themselves.<sup>66</sup>

### 3.4.1 Kurdish Religious Minorities

Within Iraqi Kurdistan, the most common of the sects which probably have an Islamic origin are the Ahl-i Haqq and the Yezidis. Ahl-i Haqq<sup>67</sup> is a small sect found in south and south-eastern Kurdistan that is probably a Shi'i syncretistic deviation. The central belief is in seven successive manifestations of the Divinity. Although Ali (the Prophet Mohammed's son-in-law) is venerated, the focus of the sect is on the founder of the Ahl-i Haqq, Sultan Sahak.<sup>68</sup>

Another syncretistic sect, the Yezidis are often incorrectly termed 'devil-worshippers'. The origin of this sect appears to have been Sunni Islam, which has progressively incorporated elements of virtually every regional religion, including paganism, Zoroastrianism, Manicheanism, Judaism, Nestorian Christianity, and other Muslim features.<sup>69</sup> The main concentrations of Yezidis are in the Kurd Dagi district north of Aleppo in Syria, in the Sinjar mountains on the Syrian-Iraqi border, and in the south-western Caucasus. There is also a major concentration in Iraqi Kurdistan at Ain Sifni, with their most sacred shrine of Shaikh 'Adi, south of Aqra, although there are many Yezidis spread out over the rest of the territory.<sup>70</sup> Yezidis claim to be Kurdish, but due to religious and cultural differences, and a definite pride in their identity, they are notably different to non-Yezidi Kurds. In the past Yezidis have faced persecution at the hand of their Muslim neighbours. However, in the 1990s the situation seems to have improved. It is not uncommon to find Yezidis in positions of

---

<sup>65</sup> McDowall goes as far to say that religious belief plays no part in Kurdish distinctiveness. McDowall (1992) *op. cit.*, p. 13.

<sup>66</sup> My use of terminology is open to debate regarding geographical names and ethnic groups. The Assyrians of Erbil, for example would accept the label "non-Kurd", but like to label the territory as Ashur, rather than Kurdistan. They would then become Assyrians in Ashur.

<sup>67</sup> "Ahl-i Haqq" translates into "People of the Truth". McDowall (1992) *op. cit.*, p. 14.

<sup>68</sup> *Ibid.*

<sup>69</sup> *Ibid.*

<sup>70</sup> Bruinessen (1992b) *op. cit.*, p. 6.

responsibility in Iraqi Kurdistan, and even in high-ranking positions in the political parties and the KRG.

### 3.4.2 Non-Kurdish Minorities

There have always been non-Kurdish elements living amongst the Kurds. The two most distinctive are the Turkomen and Christians. The Turkomen share the same religious beliefs (and divisions) as the Kurds, but the Christians display a different religion, as well as being of a different ethnic origin.

The Christian community in Iraqi Kurdistan is divided into distinct confessional groups. The largest Christian community used to be the Armenians, but, after assimilation with the surrounding peoples and conversion to Islam and the development of a Kurdish identity in the late nineteenth century and the mass deportation and massacres of Armenians in the Kurdish region in 1915, there are few Armenians left in Iraqi Kurdistan.<sup>71</sup>

In present-day Iraqi Kurdistan, the largest Christian community is the Assyrians. Assyrian communities are concentrated in specific areas of Dohuk and Erbil cities, Diyana in Erbil Governorate, and localised villages. Other Christian communities include the Chaldeans. Both of these groups speak the Aramaic language and have a strong cultural identity. However, relations between the two groups are not close, and are against such practices as inter-group marriage. Christian relations with the Kurds are, again, complex. There have been cases of aggression between the two groups, but these are isolated incidents. Due to Christians occupying specific parts of the urbanised areas, contact between the two groups is minimal.

The Assyrians also have political parties with their own militia, dominated by the Assyrian Democratic Movement (ADM), their own television and radio stations, and five seats in the KNA. Furthermore, there are powerful political characters in the KDP especially who are Christian, and, while not ostensibly being employed for their

---

<sup>71</sup> *Ibid*, pp. 6-7.



religious credentials, do portray an image that the party is working for the Kurdistan region as a whole, rather than the Kurdish people in particular.<sup>72</sup>

Finally, there are numerous pockets of non-Kurdish Muslims in Iraqi Kurdistan. There is a belt of Turkomen towns and villages running north to south throughout Iraq. The largest of these towns is Kirkuk, and Erbil also has a sizeable Turkoman population<sup>73</sup>. The Turkomen themselves have a strong cultural awareness of being Turkic. Relations between the Turkomen and the Kurds have often been violent, and have been recently, mainly because the Turkomen are obvious proxies for their ethnic cousins, the Turks, to use against Kurdish independence in Iraq. The presence of Turkomen in Kirkuk and Erbil has also been an argument the Government of Turkey uses in irredentist claims on Iraqi Kurdistan. In 1959, a political conflict in Kirkuk gave rise to heavy bloodshed between the two groups<sup>74</sup> and in August 1998; the KDP destroyed the offices of the Turkoman Front in Erbil following the increased political activity of the organization.<sup>75</sup>

### **3.5 The Economic Structures of Iraqi Kurdistan**

#### **3.5.1 Introduction**

The political and social structures of contemporary Iraqi Kurdistan have been greatly influenced by their traditional mode of production. The agrarian foundations of the society promulgated a political and social infrastructure and, subsequently, patterns of interpersonal relationships governing Kurdish decision-making and political activity.<sup>76</sup> For example, Dzeigiel describes the origin of the Iraqi Kurdish tribal system as being rooted in the activities of settled or semi-nomadic farmers, and

---

<sup>72</sup> The most famous Christian politician in Iraqi Kurdistan is Franso Hariri. He is a member of the Central Committee of the KDP (although with Political Bureau influence), Governor of Erbil (until 2000), Member of Parliament, Minister of Region (Minister without Portfolio), and the Chairman of many inter-departmental committees in the Governorate of Erbil.

<sup>73</sup> The Turkomen also say that Erbil is originally a Turkoman city rather than a Kurdish one. Similarly, the Assyrians also claim Erbil to be an Assyrian city.

<sup>74</sup> Marr (1985) *The Modern History of Iraq*. Boulder CO: Westview Press, pp. 164-166.

<sup>75</sup> This was an interesting event. Throughout the whole of the summer of 1998, the Turkoman Front was taking an increasingly provocative line against the KDP, including establishing more party offices than the KDP in Erbil City, and paying Kurds to register as being Turkish. The GOI was also displaying great concern over these actions and, after numerous discussions between KDP representatives and the GOI, the KDP closed down all the Turkoman Front offices in Erbil City, by force when necessary.

<sup>76</sup> For evidence of the inter-relationship, see: Leach (1940) *Social and Economic Organisation of the Rowanduz Kurds*, Monographs on Social Anthropology No. 3, LSE. London: Percy Lund, Humphries & Co, pp. 13-27; Dzeigiel (1981) *op. cit.*, pp. 35-48.

subsequently describes the development of tribal political structures from this point of reference.<sup>77</sup> This mode of production has left a legacy in contemporary Iraqi Kurdistan with relations, and styles of tribal relations and hierarchies, being traceable to the traditional agrarian mode of production.

This idea in itself is not unique to the Kurds, but is one which has been often taken for granted in analysing Kurdish politics. The study of the economic situation of Iraqi Kurdistan may provide further assistance in understanding Kurdish politics, and Leezenberg notes that "*attention to the economic interests involved can give a better idea of the motivations for political behaviour which might otherwise seem difficult to explain rationally.*"<sup>78</sup>

What is of further interest are the changes which the Kurdish economic characteristics have been forced through, and the impact that such rapid changes have and could have on Kurdish politics and society. The aim of this section is to partly fulfil this requirement by providing an understanding of the Kurdish economy, the impact of economic activity on political structures and political relationships, and an appraisal of the Iraqi Kurdish economy in the 1990s.

The changes inflicted upon Iraqi Kurdish society by the impact of damaging GOI policies and events can be seen clearly in the economic sector. What should be an economy structured around the agrarian sector, with most of the incoming revenue being derived from the infrastructure and services provided by an immense national oil revenue being heavily eroded.<sup>79</sup> During the 1980s, the GOI spent great sums of money in Iraqi Kurdistan, enabled to do so through the oil revenue. This wholesale spending urbanized Iraq, including the Kurdish regions, and created a culture of dependency upon central government within Kurdish society, an attitude which has proved difficult to overcome.<sup>80</sup>

---

<sup>77</sup> Dzeigiel (1981) *op. cit.*, pp. 36-48.

<sup>78</sup> Leezenberg (1999a) *Refugee Camp or Free Trade Zone? The Economy of Iraqi Kurdistan Since 1991*. Unpublished paper, University of Amsterdam, Netherlands, p. 2.

<sup>79</sup> Ghassemlou (1965) *op. cit.*, pp. 85 - 88; Sajjadi (1991) *op. cit.*, p. 49.

<sup>80</sup> For an analysis of the socio-economic transformation of Iraq, see Marr (1985) *op. cit.*, p. 285; Leezenberg (1999a) *op. cit.*, p. 2



The economy of Iraq as a whole, and Kurdistan in particular, was devastated by the Iran-Iraq War. In this last period of GOI control in Iraqi Kurdistan, the military forces of the Ba'ath dominated government wrought unprecedented destruction in the rural areas of Iraqi Kurdistan in the infamous *Anfal* Campaigns, and in doing so fundamentally altered the agrarian foundations and structures of the economy.

The period after the Second Gulf War has seen the economy of Iraqi Kurdistan placed under double sanctions, firstly by the UN<sup>81</sup>, and then by the GOI<sup>82</sup>, effectively creating an overall embargo and an embargo within it. These embargoes created immense hardship for the population of Iraq and Iraqi Kurdistan. But, this hardship went some way in curing the inherent weakness of the Kurdish economy, the dependency built into the system by the GOI, by taking away any external source of economic support.

This was a period of immense hardship for the Kurds, but, with the Kurdish political parties and the KRG increasingly coming to terms with this situation, and limited assistance being provided by UN agencies and NGOs, the Kurdish economy looked to be making some form of improvement, particularly in the all important agricultural sector. However, the planning and implementation of UN SCR 986, and subsequent renewals of this resolution, have weakened the progress made in the 1990s and again gone some way in creating a culture of dependency amongst the Kurdish populace with free food baskets, and simultaneously undermined the recovering agrarian base by not buying any of the food items from the Iraqi Kurdish regions. Simultaneously, an energetic informal economy based on services and trade developed which has made the task of regulating the economy of Iraqi Kurdistan extremely difficult.

The following account of the economy of Iraqi Kurdistan is based along the subject areas mentioned and analyse the use of economic policies, or policies with an economic impact, by the central government against the Kurds. An analysis of the traditional mode of production of Iraqi Kurdistan has to be undertaken to provide a comparison for the changes which have since affected the region.

---

<sup>81</sup> UN SCR 661 was adopted on 6 August 1990 and called on all member states to impose a comprehensive package of financial and economic sanctions. (UN SCR 661, para 3-4).

<sup>82</sup> Imposed with the withdrawal of GOI administration and forces in October 1991.

### 3.5.1.1 The Traditional Agrarian Mode of Production

The relationship between politics and modes of production is explained by Ayubi who states that “most forms of power . . . in the majority of cases . . . [are] . . . rooted in the economic base and, more specifically, in the modes of production.”<sup>83</sup>

Ayubi furthers his discussion of traditional economy as being a ‘mode of production’ comprising forces of production and the relations of production, with the latter characterising the patterns of organizing the labour process, the ownership and control of the means of production, and the distribution of economic surplus. It is argued that this group of conditions mould and colour successive political structures and culture in general.<sup>84</sup>

### 3.5.1.2 Oil and the Agrarian Economy

Before the upheavals presented by the political struggles between the Kurds and the GOI, and subsequent crises between the GOI and the international community, the indigenous, and realised basis of the Iraqi Kurdish economy was, and is, agrarian.<sup>85</sup>

The extraction of oil from Kurdish dominated regions around Kirkuk may also indicate that an oil economy may similarly be identified as a natural means of economic production, particularly as the greater part of the region’s national revenue is from this source.<sup>86</sup>

However, the impact of the oil industry has not been the same as that of a traditional mode of production.<sup>87</sup> The political elite of Iraqi Kurdistan do not own the means of production, nor control the labour force, both of which are important requirements, according to Ayubi, for analysing the impact of a particular mode of production upon a political structure.<sup>88</sup> This argument of the relationships between control of modes of

---

<sup>83</sup> Ayubi (1995) *Over-Stating the Arab State: Politics and Society in the Middle East*. London: IB Taurus, p. 38.

<sup>84</sup> *Ibid*, pp. 39-41; Rumaihi (1980) “The Mode of Production in the Arab Gulf Before the Discovery of Oil,” in Niblock (ed.) *Social and Economic Development in the Arab Gulf*. London: Croom Helm.

<sup>85</sup> I use the terms indigenous and realised to describe those modes of production which are in Kurdistan, and in the control of the Kurds themselves. The oilfields of Kirkuk and Mosul have never been under the control of the Kurds, and therefore are not classed as indigenous or realised modes of production. The impact of this industry is, however, uncontested although it is in an indirect manner.

<sup>86</sup> Sajjadi, (1991) *op. cit.*, p. 49.

<sup>87</sup> This is not to say that there is no illegal involvement with the oil industry of Iraq. As we shall see, the KDP and PUK have been involved in illegal smuggling petroleum products, contravening the UN sanctions imposed by SCR 661.

<sup>88</sup> Ayubi discusses this in terms of addressing the sources of power. Ayubi (1995) *op. cit.*, p. 38, quoting Runciman (1989) *A Treatise on Social Theory*. Cambridge: Cambridge University Press.



production and political structures supports the observations of Ghassemlou who, with reference to Iraqi Kurdistan, stated that;

*“It is a peculiar feature that the Kurdish industrial proletariat arose without the simultaneous rise of a Kurdish national industrial bourgeoisie; this phenomenon can be explained by the [fact] that the exploitation of oil is exerted either by imperialist companies or by a state sector.”*<sup>89</sup>

The impact of the oil industry has mainly been through the expenditures of the GOI, rather than impacting directly the economic and political organization of Kurdistan, with the general economic organization of Iraqi Kurdistan remaining mainly agrarian.<sup>90</sup> Other industries remained underdeveloped. Mining was developed to a low degree, and there is only a light industrial base present.<sup>91</sup>

### 3.5.2 The Economy Before the Algiers Agreement of 1975

Iraqi Kurdistan has rarely enjoyed long periods of peace and political stability, but the period before the mid-1970s, and particularly before the commencement of the Kurdish revolt in 1961, can be considered such a period. It is, admittedly, a relative stability, but the problems of these earlier periods are not of the same magnitude as the problems which erupted from the mid-1970s onwards.

#### 3.5.2.1 The Agriculture Sector

Agriculture has been the backbone of the Kurdish economy. In the past, this economy has been so strong that the region provided the markets of Mesopotamia, Syria, Turkey, the Transcaucasus and Iran with agricultural products for centuries.<sup>92</sup> The predominance of agriculture could be seen in the numbers of people dependent upon the sector during the 1970s. According to Sajjadi, more than half of the population was dependent on agriculture up to the late 1970s, and Vanly suggests a higher number with 55% dependent in 1975.<sup>93</sup> Furthermore, Sajjadi contends that Iraqi Kurdistan produced as much as 45% of Iraq's wheat, and a third of its barley in 1980 (see Table 3.5).

---

<sup>89</sup> Ghassemlou (1965) *op. cit.*, pp. 85-86.

<sup>90</sup> Sajjadi (1991) *op. cit.*, p. 49.

<sup>91</sup> Ghassemlou (1965) *op. cit.*, p. 85.

<sup>92</sup> Dzeigiel (1981) *op. cit.*, p. 36.

<sup>93</sup> *Ibid.*

Although Iraqi Kurdistan is described as a fertile land, less than half the land at this time was suitable for cultivation, and of this only 1.1 million hectares were tilled up to the early 1980s.<sup>94</sup> This situation was evident since the onset of large-scale extraction of oil, and particularly since the state secured direct control of the oil industry between 1972 and 1975.<sup>95</sup> Stork estimates that the total arable and total cultivated land declined by perhaps as much as 30 per cent between 1958 and 1977.<sup>96</sup>

Iraqi Kurdistan in the 1970s was a highly productive agricultural region. However, there were some internal problems related to the issue of land reform programmes. A ceiling of 250 hectares of irrigated or 500 hectares of rain-fed land was applied throughout Kurdistan, but not fully implemented until the latter half of the 1970s.<sup>97</sup>

**Table 3.5: Production of Wheat and Barley in 1980**<sup>98</sup>

	<i>Production of Wheat ('000 ton)</i>	<i>%</i>	<i>Production of Barley ('000 ton)</i>	<i>%</i>
<i>Iraqi Kurdistan</i>	440	45	227	33.3
<i>Rest of Iraq</i>	536	55	445	66.7
<i>Turkey</i>	976	100	682	100

The implementation of these policies was not achieved in a uniform manner by the GOI. The resultant internal upheavals, frequent changes of government policies and civil service personnel and modified agrarian law created an environment of uncertainty in rural areas. Furthermore, one of the outcomes of the implementation of the laws was state agencies taking control of the most productive land on behalf of the GOI.<sup>99</sup> The result was a depressed agricultural sector and the increase of rural-

<sup>94</sup> *Ibid.*

<sup>95</sup> For further information on the changes the expanding oil industry made to the economic structure of Iraq at this time, see Stork (1982) "State Power and Economic Structure: Class Determination and State Formation in Contemporary Iraq," in Niblock, (ed.), *Iraq: The Contemporary State*. London: Croom Helm, pp. 27-46.

<sup>96</sup> Dzeigiel (1981) *op. cit.*, p. 34.

<sup>97</sup> Sajjadi (1991) *op. cit.*, p. 50.

<sup>98</sup> Sajjadi (1991) *op. cit.*, p. 50, quoting Central Statistical Office of Iraq figures for 1980.

<sup>99</sup> *Ibid.*



urban migration,<sup>100</sup> draining manpower and knowledge from the rural areas and increasing inner-city style social and economic problems.

### 3.5.2.2 The Oil Sector

Oil is the dominating factor in the Iraqi economy and, similarly, it is commonly said that oil forms the most important part of the economy of Iraqi Kurdistan.<sup>101</sup> As we have discussed, this is only partly correct. Although the major oilfields of Iraq are located in territory populated by Kurds, the fact that the control of these fields lies with the GOI and not the Kurds themselves means that the benefits to the Kurds from these fields are limited to labourers working in the oil industry, whether in Kirkuk or on the pipelines or distribution systems, and from the GOI spending achieved by the high oil-rent available. However, the oil sector is commonly mentioned as being a part of Iraqi Kurdistan's economy, and as such must be studied.

Petroleum products accounted for 90% of Iraq's exports until the imposition of sanctions, and at its peak the production capacity has been over three million barrels per day, with proven reserves of more than 100 billion barrels.<sup>102</sup> The most important oilfields in Iraq are located at Kirkuk, with estimated reserves of 16,000 million barrels and an output of 2.8 m.b/d in 1988.<sup>103</sup>

### 3.5.2.3 Manufacturing Industry

During this period of industrialisation in Iraq as a whole, Iraqi Kurdistan was relatively ignored by the development boards of the GOI.<sup>104</sup> The industrial sector was therefore not developed at the same rate as the rest of the country, and developed along smaller consumer orientated lines, with the Kurdish region being the market. Common industries included cement, cigarette-making, furniture, stone, and bricks. The small scale of the industry is emphasised by official GOI figures stating that the number of people engaged in the industrial sector in Kurdistan at this time represented only 7.7 % of the total industrial employees in the country, and that the autonomous region of Kurdistan was home to only 4.9 % of heavy industry, and 11.1

<sup>100</sup> *Ibid.*

<sup>101</sup> *Ibid.*, p. 52; Dziegiel (1981) *op. cit.*, pp. 35-36.

<sup>102</sup> Dreze & Gazdar (1992) "Hunger and Poverty in Iraq, 1991." *World Development*, Vol. 20, No. 7, pp. 921-945, pp. 922-923.

<sup>103</sup> Europa (1990) *Middle East and North Africa*, p. 168.

% of smaller industrial plants of Iraq.<sup>105</sup> By 1990, there were only nine major factories in Iraqi Kurdistan, mostly producing cement and tobacco. Kurdistan again remained dependent on the centre and south of the country for the products of manufacturing industries.<sup>106</sup>

### 3.5.2.4 The Public Sector

Perhaps the greatest impact the oil industry has on Iraqi Kurdistan was the predominance of the public service sector in the regional economy. This sector includes the armed services, civilian public services including administration and social services. The standard of the Iraqi social services was acknowledged to be among the highest in the Middle East, but needed a large workforce to satisfy public sector requirements.<sup>107</sup>

#### 3.5.2.4.1 *The Ministry of Northern Affairs*

The situation was similar in Iraqi Kurdistan as in the rest of the country, and particularly so after a Minister for Northern Affairs was appointed to the Iraqi Cabinet of Ministers. The Minister appointed for the task of effectively reconstructing Kurdistan in the aftermath of the Kurdish Revolt of 1961-1970 was Mohammad Mahmoud (Sami) Abdel Rahman. The appointment was by agreement between Mulla Mustafa Barzani and the GOI.<sup>108</sup> Schools and hospitals were built in every district-centre town, and Sami claims that his ministry was responsible for the building of 600 schools, 18,000 houses, 15 hotels and 2,500 kilometres of road.<sup>109</sup> In terms of construction projects, Sami described 1970-1974 as being a “golden era” for the Kurds, particularly as the Governors were also members of the KDP and the influence of the GOI was minimal.<sup>110</sup> Governorate administrative structure within the Kurdish north was identical to that which existed in other governorates. However,

---

<sup>104</sup> Sajjadi (1991) *op. cit.*, p. 52; Dreze & Gazdar (1992) *op. cit.*, p. 923.

<sup>105</sup> Sajjadi (1991) *op. cit.*, p. 52.

<sup>106</sup> Figures from Leezenberg (1999) *op. cit.*, p. 2, quoting Hafeed (1993) “The Embargo on Kurdistan: Its Influence on the Economic and Social Development,” in Hussein and Leezenberg, (eds.) *The Reconstruction and Economic Development of Iraqi Kurdistan: Challenges and Perspectives*. Amsterdam: Netherlands Kurdistan Society, p. 40.

<sup>107</sup> Dreze & Gazdar (1991) *op. cit.*, p. 923.

<sup>108</sup> Henceforth known as Sami Abdel Rahman. Sami was also the main negotiator of the 1970 March Agreement on Autonomy and is currently the Chairman of the KDP Political Bureau.

<sup>109</sup> Interview with Sami Abdel Rahman, Salahadin, 3 April 1998.

<sup>110</sup> *Ibid.*



according to Sami, many of the key positions within the administration were staffed by Arabs rather than by Kurds.<sup>111</sup>

### 3.5.2.5 Conclusion

The Iraqi Kurdish economy was therefore overwhelmingly agrarian in terms of employment, but dependent financially upon the distribution of oil revenue. The ramifications of a large national oil industry, with fields located in Kurdish territory but controlled by the state, was beginning to have an impact on the socio-economic structure of Kurdish society, and succeeded in creating a large middle-class dependent on the central government. Kurdish agriculture was beginning to suffer under the stresses of political instability caused by the Kurdish Revolt of 1961-1970 and inter-factional disputes between Kurds, and also by the attempts at land reform by the central government. Industry was poorly developed, and employed few Kurds. The social security system was extensive, and supported by the revenue accrued from oil rent. There was therefore an overall dependency on the distribution of oil wealth from the GOI developing, and particularly amongst the increasing urban population.

### 3.5.3 The Economy During the 1970s and 1980s

The Iraqi Kurdish economy, in this state, came to an abrupt end in 1975. The Kurdish Revolt of 1961-1970 was ended by a truce between Mulla Mustafa Barzani's KDP and the GOI, resulting in the 1970 March Agreement. However, the situation deteriorated over disagreements regarding the delimitation of the autonomous territory and fighting again broke out in 1974 due to the GOI not honouring the obligations as agreed in 1970.<sup>112</sup> The withdrawal of Iranian support to the KDP after the Algiers Agreement of 6 March 1975 was concluded between Iraq and Iran resulted in the defeat of the Kurdish movement and the routing of KDP forces, with perhaps as many as 100,000 Iraqi Kurds, civilians and peshmerga, fleeing to Iran.<sup>113</sup>

---

<sup>111</sup> *Ibid.*

<sup>112</sup> Key points of disagreement centred on the GOI's unwillingness to relinquish control of strategic border areas with Syria (Jabal Sinjar), and attempting to Arabize the Kirkuk and Khanaqin oil producing regions. Stichting Nederland-Koerdistan (1996) *op. cit.*, p. 7.

<sup>113</sup> Iraq made concessions to Iran in its conflict over the use of the Shatt al-Arab, in exchange for which the Shah gave up his support of the Kurds in revolt in Iraq. (Stichting Nederland-Koerdistan (1996) *op. cit.*, p. 7; McDowall (1996) *op. cit.*, pp. 338-339). For a comprehensive analysis of the Algiers Agreement, including regional impact, see Abdulghani (1984) *Iraq and Iran: The Years of Crisis*. Baltimore: Johns Hopkins University Press, pp. 152-177.

### 3.5.3.1 The Algiers Agreement

In order to prevent Kurdish guerrilla forces gaining footholds in the mountainous border territory of Iraq, the GOI declared a broad swathe of land 5-30 kilometres wide along the border with Turkey and Iran a forbidden zone.<sup>114</sup> The area was evacuated, villages destroyed, trees burnt and wells filled with concrete. Estimates of the number of villages and settlements destroyed in 1975 vary considerably, as it is difficult to separate the destruction attributable to the Algiers Agreement from that of subsequent Iraqi military operations in the 1980s. Sajjadi puts the figure of villages along the Iranian border razed by the Iraqi government at 800, and McDowall suggests that 500 villages were destroyed in the first phase of operations, and may have reached 1,400 villages by 1978.<sup>115</sup>

Displaced peoples from these forbidden border areas were deported to the infamous collective towns. Again, numbers vary but at least 600,000 men, women and children were forced from their villages into these custom built settlements.<sup>116</sup> Anyone caught attempting to return risked being summarily executed by the GOI military based in the settlement.<sup>117</sup> The cost of these operations to Iraqi Kurdistan are impossible to accurately estimate either in terms of absolute financial cost, human suffering, destruction of the environment, and loss of knowledge. The rural areas particularly were devastated. Karadagi notes that;

*“The expulsions, the building of new villages, and the compensations to expellees, cost the government hundreds of millions of Iraqi dinars after 1975. The real cost, including the destruction of the economic structure of these agricultural areas, ran into billions. Money was certainly spent in Kurdistan at that time, but its purpose was not redevelopment as much as the change in demographic balance through piecemeal Arabization.”<sup>118</sup>*

<sup>114</sup> The extent of this zone varies. McDowall describes it as being progressively widened from 5 kilometres to 30 in places (McDowall (1996) *op. cit.*, p.339). Karadaghi describes it as being between 5 and 15 miles in width, containing 1,500 villages. Karadaghi (1993) “The Two Gulf Wars: The Kurds on the World Stage, 1979-1992,” in Chaliand (ed.) *A People Without a Country: The Kurds and Kurdistan*. New York: Olive Brach Press, p. 216.

<sup>115</sup> Sajjadi (1991) *op. cit.*, p. 51; McDowall (1996) *op. cit.*, p. 339.

<sup>116</sup> Karadaghi estimates that 750,000 people were relocated to the *mujama'at*. Karadaghi (1993) *op. cit.*, p. 216.

<sup>117</sup> McDowall (1996) *op. cit.*, p. 339.

<sup>118</sup> Karadaghi (1993) *op. cit.*, pp. 216-217.



This policy of systematically destroying the rural infrastructure and deporting villagers continued and intensified through the 1980s as the relationship between the Kurdish parties (mainly the PUK) and the GOI progressively stalled and worsened, and the cooperation between PUK peshmerga and Iranian military forces increased. The aim of the GOI was ostensibly to inhibit the ability of Kurdish guerrillas operating in the mountains but there was possibly a parallel aim of weakening Kurdish society at its most fundamental level by devastating the agricultural base of the region, forcing increased dependency on the distribution of oil revenues by the GOI. The combined threat of the Iranian military and Kurdish peshmerga heralded the commencement of the most infamous attacks yet to take place against the Iraqi Kurdish population.

### 3.5.3.2 The Iran-Iraq War and the Anfal Campaign

The tactics employed during 1975 were succeeded by progressively worse attacks on the Kurdish infrastructure, culminating in the infamous *Anfal* Campaigns of the late 1980s which were characterised by the comprehensive destruction of the rural environment and infrastructure, deportation of the Kurdish population, and the use of chemical weapons on the civilian population. Furthermore, running throughout this period, and impacting the Iraqi Kurdish economy both in a direct way with army drafting, destruction of economic infrastructure, and population displacements, and in an indirect manner with the reduction of the overall oil revenue of the GOI, was the Iran-Iraq War. Commencing on 22 September 1980, this war had profound implications for Iraqi Kurdistan as the region effectively became a war zone.<sup>119</sup>

#### 3.5.3.2.1 *The Impact of the Iran-Iraq War and the Anfal Campaigns*

The Iran-Iraq War devastated the Iraqi economy. At the beginning of hostilities, it was estimated that Iraq possessed an estimated US\$ 35 billion in foreign reserves. These rapidly disappeared when the economic development programmes of the GOI were combined with increased military expenditures of US\$ 1-2 billion per month.<sup>120</sup> However, with the assistance of the international community, and particularly Saudi Arabia and Kuwait, the Iraqi economy was supported by loans, with states accepting

<sup>119</sup> For an analysis of the causes and implications of the Iran-Iraq War, see Abdulghani (1984) *op. cit.*

<sup>120</sup> Axelgard (1986b) "War and Oil," in Axelgard, (ed.), *Iraq in Transition: A Political, Economic, and Strategic Perspective*. Centre for Strategic and International Studies, Georgetown University, Colorado: Westview Press, p. 8.

Iraq's short term difficulties, but recognizing the longer term viability of the oil-rich state and the need to have a strong Iraq to balance Iran.<sup>121</sup>

The *Anfal* Campaigns were a series of related assaults against Kurdish-Iranian positions in Iraqi Kurdistan, undertaken by targeting the entire population in designated rural areas with a full military offensive combining conventional and chemical weapons. By February 1988, 1.5 million people had already been deported and over 3,000 villages razed.<sup>122</sup> 5000 civilians were killed in Halabja on 15 March by a chemical attack. By the end of the operations, it was estimated that 150 – 200,000 people were killed, 4,000 settlements destroyed, at least 1.5 million people resettled and, according to the Iraqi Kurdistan Front, by July 1988, 45,000 out of 75,000 square kilometres of Kurdistan had been cleared.<sup>123</sup>

The aim of destroying the strongholds of the peshmerga by targeting rural areas resulted in the depopulation of the countryside either by deportation or evacuation, and rendered large swathes of land unviable for agricultural usage due to the presence of chemical weapons, unexploded ordnance, and landmines. To prevent reoccupation, the GOI forces totally destroyed the villages, cut down vegetation and destroyed wells, springs, and irrigation projects.<sup>124</sup> The impact on agriculture was immense, and has a legacy into the next century. The Guardian noted that;

*“ . . . since 1988, when Saddam Hussein completed a campaign [the Anfal Campaign] to relocate rural Kurds in camps close to towns, razing 4,000 villages in the process, there has been little agriculture in [Iraqi] Kurdistan. The region's food supplies have had to be brought in by truck from the south.”*<sup>125</sup>

<sup>121</sup> Crusoe (1986) “Economic Outlook: Guns and Butter, Phase Two?” in Axelguard, (ed.), *Iraq in Transition: A Political, Economic, and Strategic Perspective*. Centre for Strategic and International Studies, Georgetown University, Colorado: Westview Press, p. 83.

<sup>122</sup> Daily Telegraph, 4 March 1988.

<sup>123</sup> According to the PUK, 3839 villages, 1757 schools, 2457 mosques, and 271 hospitals and medical centres were destroyed and 219,828 families totalling approximately 1.5 millions persons were deported. An ECHO report puts the figure of destroyed villages at 3,886 out of the existing 4,459 (87%). McDowall (1996) *op. cit.*, p. 366; Menichini (1996) *Evaluation Report on Humanitarian Operations in Northern Iraq*. Report prepared on the request of the European Community Humanitarian Office (ECHO), January 1996, pp. 8-9.

<sup>124</sup> Sajjadi (1991) *op. cit.*, p. 51.

<sup>125</sup> The Guardian, 16 March 1991, p. 28 (quoted in Sajjadi (1991) *op. cit.*, p. 51).





### 3.5.3.3 Conclusion

If the figures were studied without an understanding of the human misery behind them, the situation at the end of the 1980s in the period before the Second Gulf War did not appear to be too critical. Before the uprising of 1991, Iraqi Kurdistan was part of an upper middle-income country with a GDP per capita of approximately US\$ 3,000. Social services were freely provided by the state, food was highly subsidised, and, due to the strength of the Iraqi Dinar, imported products were reasonably priced. Government corporations distributed salaries to a great part of the population and, due to the construction of the collective settlements, many people were employed in the building sector.<sup>126</sup> This highly promising picture of Iraq as a whole is ideally portrayed in the following description;

*“ . . . . by the end of the 1980s, 92% of the population had access to safe water . . . . and an impressive 93% lived in the catchment areas served by modern health facilities. The government’s network of health centres and hospitals was well disseminated, well supplied, well staffed, and effectively if rather clinically engaged with the population in their jurisdictions. Iraq had converted oil wealth into enhanced social well-being with considerable success. Education expanded, child mortality declined, and life expectancy increased all quite impressively.”<sup>127</sup>*

However, this description hides the fact that nearly 90% of villages had been razed; their inhabitants forced into 78 collective settlements and removed from their ancestral areas; only farmers close to the Ba’ath Party or southern Arabs had access to agricultural land; and public expenditure was not planned with any thought for socio-economic implications.<sup>128</sup> This is particularly important for the agricultural sector which, in its massively weakened state, could not hope to compete against the cheap imports of food the GOI was bringing into the country – a situation which would repeat itself with the implementation of UN SCR 986.<sup>129</sup>

The rural infrastructure had been devastated. Huge settlements characterised by martial law and overcrowding now dotted the landscape, all totally dependent upon

<sup>126</sup> Menichini (1996) *op. cit.*, pp. 8-9.

<sup>127</sup> Field (1993) “From Food Security to Food Insecurity: The Case of Iraq, 1990-1991.” *Geojournal* Vol. 30, No. 2, (June), pp. 185-194.

<sup>128</sup> Menichini (1996) *op. cit.*, p. 9.

<sup>129</sup> *Ibid.*

the GOI for their livelihoods and the extensive food distribution system.<sup>130</sup> The countryside was depopulated and the political parties massively weakened. The political aims of the Algiers Agreement and the *Anfal* Campaigns have been well documented. There was also an economic attack on Kurdish society, aimed at weakening the structures which dominated the Kurdish way of life, politics, and uniqueness. This assessment is supported by the following statements;

*“Through a rational strategy aimed at controlling politically the Iraqi Kurds by undermining their economy, over a period of about 15 years, the Kurdish producers had been changed into consumers, completely dependent on subsidies.”<sup>131</sup>*

*“Socially, they [the Anfal Campaigns] brought the destruction of traditional bases of livelihood and Kurdish village culture. Large rural areas were left totally desolate, and even several larger cities, in particular Halabja and Qala Diza, were completely evacuated and destroyed.”<sup>132</sup>*

The destruction of the traditional Kurdish economy was comprehensive. Combined with the unprecedented scale of human suffering caused by deportations, harassment, summary executions and the targeting of civilians with conventional and chemical weapons, on the eve of the invasion of Kuwait and the commencement of the Second Gulf War, Iraqi Kurdistan was a broken land. The Kurdish economy was devastated, its society increasingly rootless, the political parties weak and demoralised, and the Kurds a broken, tired people.

#### 3.5.4 The Economy in the 1990s

The imposition of sanctions on Iraqi Kurdistan, firstly by the UN and then by the GOI had a profound effect upon the economic and socio-economic status of the region and its people.<sup>133</sup> The Iraqi Kurdish infrastructure had been systematically destroyed by 15 years of targeted degradation of the rural areas and eight years of destructive warfare. Furthermore, the region had been forced into being economically dependent on the welfare system established by the GOI. However, whilst the

---

<sup>130</sup> Leezenberg suggests that the productive rural community of Iraqi Kurdistan was changed into an urban consumer society (Leezenberg (1999) *op. cit.*, p. 3).

<sup>131</sup> *Ibid.*

<sup>132</sup> Stichting Nederland-Koerdistan (1996) *op. cit.*, p. 10.

<sup>133</sup> The sanctions regime commenced with the implementation of SCR 661, 6 August 1990.



descriptions of this period are distressing, the situation was one of relative, rather than absolute, decline as the following quotations illustrate;

“ . . . . the Iraqi welfare state was, until recently, among the most comprehensive and generous in the Arab World . . . . which ensured that Iraqis had the highest calorific consumption per head in the Middle East by the end of the decade [1980s].”<sup>134</sup>

“What we have in Iraq is a situation of rapid decline . . . . on the part of a society that had previously experienced over three decades of successful development.”<sup>135</sup>

#### 3.5.4.1 The Sanctions Regime

Iraq as a whole was hard hit by the imposition of sanctions and the subsequent lack of hard currency.<sup>136</sup> SCR 661 of 6 August 1990 was the Security Council's response to Iraq's invasion of Kuwait. The Security Council simultaneously created a Committee of the Security Council to carry out tasks related to the imposition of sanctions, commonly known as the Iraq Sanctions Committee.<sup>137</sup> SCR 661 was the most comprehensive and effective sanctions regime in history, placing a total ban on all Iraqi imports and exports.<sup>138</sup>

This total blockade was subsequently slightly relaxed by paragraph 6c, permitting the import of supplies intended strictly for medical purposes, and, in humanitarian circumstances, foodstuffs.<sup>139</sup> Upon the cease of hostilities between the GOI and the US-led coalition forces, SCR 687 exempted foodstuffs, and, with notification to the Sanctions Committee, materials and supplies for essential civilian needs.<sup>140</sup> The

<sup>134</sup> Economist Intelligence Unit, 1995-1996, pp. 6-7, quoted in Center for Economic and Social Rights (1996) *UN-sanctioned Suffering: A Human Rights Assessment of United Nations Sanctions on Iraq*. New York: Centre for Economic and Social Rights, p. 2.

<sup>135</sup> Field (1993) *op. cit.*

<sup>136</sup> For a comprehensive analysis of sanctions against Iraq, see Simons (1998) *The Scourging of Iraq: Sanctions, Law and Natural Justice*. London: Macmillan, particularly Chapter 3.

<sup>137</sup> The Security Council referred to the Committee as the “Security Council Committee established by Resolution 661 (1990) concerning the situation between Iraq and Kuwait.” See Conlon (1995) “Lessons From Iraq: The Functions of the Iraq Sanctions Committee as a Source of Sanctions Implementation Authority and Practice,” *Virginia Journal of International Law*, No. 3, pp. 633-668.

<sup>138</sup> CESR (1996) *op. cit.*, p. 3; Gazdar (1997) *The Economy Under Sanctions*. International Conference in Collaboration with the Iraqi Economic Forum on; Frustrated Development: The Iraqi Economy in War and Peace, Centre for Arab Gulf Studies, University of Exeter, 9-11 July 1997, pp. 1-2.

<sup>139</sup> *Ibid.*

<sup>140</sup> SCR 687, 3 April 1991, paragraph 20. The definition of *non-essential items* caused considerable disagreement with items such as pencils, textbooks and engine spares being refused. (Quoted from CESR (1996) *op. cit.*, p.4). For further details of SCR 687, including formulation and operating

sanctions imposed by the UN have been remarkably effective in achieving their aims. Oil export restrictions dealt a large blow to the economy, with Gazdar arguing that;

*“ . . . . even while imports have been prohibited, the main effect of sanctions has come through the complete shut down of oil exports and other sources of financing. This has so sharply reduced purchasing power, and raised the price of foreign exchange, that the need for import controls is limited. The result is the “temporary” shut down of an economy which was highly dependent on foreign imports financed by oil revenues.”<sup>141</sup>*

#### 3.5.4.2 The Impact of Sanctions on Iraq

By 1996, the estimated earnings of Iraq were equal to its GDP of the 1940s prior to the oil boom. Gazdar estimated that industrial production was lowered by 85%, and imports into Iraq fell from US\$ 10.3 billion in 1988 to just US\$ 0.4 billion in 1991.<sup>142</sup> Furthermore, the combined compensation to Kuwait, reparations to Iran, foreign debt, and the value of destroyed infrastructure bill came to a total of over US\$ 550 billion.<sup>143</sup> By 1995, the UN Department for Humanitarian Affairs (UNDHA) estimated that four million people were living in extreme poverty, about 20% of the population.<sup>144</sup> The consequences of such comprehensive sanctions were widespread and disastrous for the Iraqi population in general. However, the impact on the Kurdish region has had varying effects. While the economic situation has been difficult, politically, sanctions have seemingly benefited Iraqi Kurdistan. With reference to this difference, Lawrence notes that:

*“For almost a decade, three provinces in northern Iraq have been the de facto state of Kurdistan. They use their own currency, patrol their own borders. Paradoxically, the United Nations embargo that has helped devastate the economy of Iraq has provided Kurdistan with its greatest economic boom in 20 years, and its highest-ever level of personal freedom.”<sup>145</sup>*

---

procedures, see Johnstone (1994) *Aftermath of the Gulf War: An Assessment of UN Action*. International Peace Academy, Occasional Paper Series; Boulder, Colorado: Lynne Reinner Publishers; Simons (1998) *op. cit.*

<sup>141</sup> Gazdar (1997) *op. cit.*, p. 3.

<sup>142</sup> *Ibid*, pp. 8-9.

<sup>143</sup> Alnaswari estimated that the total was conservatively US\$ 586 billion, times Iraq's 1993 real GDP. (Alnaswari (1994) *Aftermath of the Gulf War: An Assessment of UN Action*. International Peace Academy, Occasional Paper Series; Boulder, Colorado: Lynne Reinner Publishers, pp. 152-153).

<sup>144</sup> Policy Planning Unit (Durham University) (1998) *The Socio-Economic Situation and the Humanitarian Aid Programme in Iraqi Kurdistan*. Unpublished report for Department for International Development, London.

<sup>145</sup> Lawrence (2000) *op. cit.*, p. 1.



The following sections analyse this paradox and presents an assessment of the economic structures which have formed in Iraqi Kurdistan during the period of the sanctions.

#### 3.5.4.2.1 *Double Sanctions*

The GOI economic blockade of the Iraqi Kurdish region was an attempt to force the Kurds to consider a political settlement.<sup>146</sup> All supplies from the centre and south of Iraq were prevented from entering the Kurdish-controlled territories. This embargo included all foodstuffs, medicine, and petroleum products. By 1992, this embargo was in full effect. Alongside this prevention of imports of essential commodities, a financial embargo was in effect with no salaries being paid to the swollen masses of civil servants, which were estimated to number 160,000.<sup>147</sup>

Several reasons have been advanced as to why the GOI blockaded Iraqi Kurdistan. Keen espouses three. First, the economic embargo of Iraqi Kurdistan provided an opportunity for Saddam to show that he could flout the actions of the UN and the Western powers which he saw as dominating the UN. Second, it was an effective way of keeping scarce supplies in GOI-controlled territory. Third, the blockade removed the problem of governing a territory at a time when the GOI lacked the resources for both administering the north, and fighting a guerrilla war in the mountains.<sup>148</sup>

#### 3.5.4.3 *Monetary Developments*

##### 3.5.4.3.1 *The New Iraqi Dinar*

Inflationary pressures in the Iraqi economy increased in 1992 due to the GOI introducing new locally printed bank notes (the New Iraqi Dinar (NID)), in addition to the regular notes in circulation which were printed in Switzerland (the Old Iraqi Dinar (OID)).<sup>149</sup> In Iraqi Kurdistan, the population had little faith in the new, poor

---

<sup>146</sup> The events of 1990-1991 are developed further in Chapter 4.

<sup>147</sup> Stichting Nederland-Koerdistan (1996) *op. cit.*, p. 19; Menichini (1996) *op. cit.*, p. 9. Henceforth, the dinar printed in Switzerland will be known as the *Old Iraqi Dinar*, or OID, and the dinar printed in Baghdad since 1992 will be known as the *New Iraqi Dinar*, or NID.

<sup>148</sup> Keen (1993) *op. cit.*, p. 31.

<sup>149</sup> Stichting Nederland-Koerdistan (1996) *op. cit.*, p. 20.

quality currency. In the markets of Erbil, Suleimaniyah and Dohuk, for example, the OID was worth as much as ten times the value of the NID in late 1992.<sup>150</sup>

#### 3.5.4.3.2 *The Kurdish Unit of Currency and Economic Controls*

The Kurdish authorities, which at this time were becoming increasingly organised, had to develop a fiscal policy to counter this manipulation of the economy. The result was the OID being chosen as the “legal” currency of Iraqi Kurdistan.<sup>151</sup> This situation has remained into 1999 and, from an economic point of view, is fascinating. The OID is not the recognised currency of the Republic of Iraq, and therefore has no international legitimacy. It is used solely in the north of the country, and has little, if any, collateral behind it. Interestingly, due to the limited supply of the OID, inflation in Iraqi Kurdistan has been of a far less magnitude than in Iraq as a whole. For example, whereas food prices increased by approximately 620% between December 1993 and December 1994, they increased by a mere 13% in Iraqi Kurdistan.<sup>152</sup> The Iraqi Kurdish economy certainly enjoys a degree of relative stability when compared with the rest of the Iraq, and this has succeeded in protecting the economic state of the Iraqi Kurdistan region, and has meant that the region has not been exposed to the same inflationary pressures as the rest of Iraq.

An interesting question to raise concerns the amount of control exerted by either the KRG or the dominant political parties upon the Iraqi Kurdish economy regarding the value of the OID. Menichini believes that there are no regulatory policies operating in Iraqi Kurdistan, and states that;

*“Without any government and/or central bank control the current economic and financial situations are strictly determined by the supply and demand law . . . . The supply, partially controlled by external factors, [impedes] any effective planning. In this context it is worth remembering that the GOI controls the flow of many goods and*

---

<sup>150</sup> *Ibid.*

<sup>151</sup> The Kurdish authorities actually considered adopting the Turkish Lira as the unit of currency for Iraqi Kurdistan during the spring of 1993. The Turkish Government was not opposed to the idea, but it seems that all parties backed down from a decision which would have had profound implications as such an act would draw the region into the Turkish sphere of influence. However, Talabani made it quite clear in 1993 that he would prefer Kurdistan to “*get rid of the Iraqi Dinar*”. Stichting Nederland-Koerdistan (1996) *op. cit.*, p. 20; The Congress, 1 July 1993, interview with Jalal Talabani.

<sup>152</sup> *Ibid*, quoting United Nations (1995a) *United Nations Consolidated Inter-Agency Humanitarian Cooperation Programme for Iraq: Mid-Term Review*, p. 1.



*energy into Northern Iraq with a view to creating there critical conditions and hence instability.*"<sup>153</sup>

However, it is apparent that the political parties 'play the markets' for their own benefits. The KDP especially, and also the PUK, hold large reserves of OI and US Dollars, and can affect the value of either on the markets of Erbil, Suleimaniyah and Dohuk. There are numerous routes by which the exchange rates are manipulated, with the more regular ones being through the limited banking system which has recently been resurrected, or more usually through the scores of money changers commonly found in any town.

Many of these money-changers are linked to a political party. The political parties, and especially the KDP, also control the trade routes with the surrounding states, and exercise customs control of imports and exports. Table 3.6 displays the PUK's estimates of the revenue generated at the Ibrahim Khalil crossing point (the main crossing point between Iraqi Kurdistan and Turkey, controlled wholly by the KDP). The financial worth of the parties is unknown, and it is not necessarily correct to equate the parties and their leaderships worth as being one and the same. For example, the PUK accuse the Barzani family of laundering huge amounts of money which accumulates in their own family accounts rather than in the accounts of the KDP or the KRG (Erbil). However, it is unlikely that Jalal Talabani is innocent of this practice either.<sup>154</sup> The powerful parties are capable of controlling the value of the OI, and have more than likely been exercising this power for some years.<sup>155</sup>

The most influential financial control relates to the presence of US Dollars on the local market. The OI-US\$ exchange rate is also influenced by political factors, and perceptions of political activity. Indeed, perception is far more important than political action in this regard. For example, when SCR 986 was being discussed, exchange rates soared, the markets were flooded with goods, and prices plummeted.<sup>156</sup>

---

<sup>153</sup> Menchini (1996) *op. cit.*, p. 9.

<sup>154</sup> Nawshirwan Mustafa Amin, the ex-leader of the Komala faction of PUK, member of the PUK Political Bureau and confidante of Jalal Talabani, stated that the Barzani's have accrued at least US\$ 1 billion in foreign reserves (interview with Nawshirwan Mustafa Amin, London, 4 March 1999).

<sup>155</sup> Menchini (1996) *op. cit.*, p. 9. This paragraph is developed from a discussion with the UN Field Delegate to Erbil, Gerhard Mortier, Erbil, 9 March 1998.

<sup>156</sup> Stichting Nederland-Koerdistan (1996) *op. cit.*, p. 20.

**Figure 3.6: Breakdown of Customs and Related Revenue Generated at Ibrahim Khalil (Zakho)**

Revenue Source	Cargo	Direction	Numbers	Tax Payable	Other Notes
Cargo trucks	Construction materials	Turkey-IK	1,000 per day	350-400 OID	These trucks import construction materials, and carries a fuel tank with a 6,000 litre capacity to export gasoline to Turkey on the return trip
Cargo trucks	Gasolene	IK- Turkey	1,000 per day	400 fils per litre.	Includes fine of 2 OID for each litre over quota (normally an extra 300 litres).
Cargo trucks	Electrical / cigarettes	Turkey - IK	50 per day	US\$ 17,000 - 17,500	Between May and June 1999, 140 trucks loaded with cigarettes entered Iraqi Kurdistan, each being cleared through customs after paying a tax of US\$ 17,500.
Oil tankers	Crude oil	Iraq - Turkey	250 per day	US\$ 5, plus 800 OID	Contracts exist between Iraqi and Turkish companies, for instance between the Turkish Antab Gas Co., for transferring 5,700,000 tonnes of crude oil. Asia Co. exports 6,000,000 litres of gasoline daily and sells in Turkey for 12 cents per litre.
Cars (tourists)	--	Turkey - IK	120 per day	US\$ 5, plus 100 OID	Every visitor to Iraqi Kurdistan also has to pay US\$ 50.
Cars (import)	Vehicles	Turkey - IK	1,000 between Jan - July 1999.	US\$ 400-750	The tax varies according to the model of the vehicle. Each year, US\$ 50 is added to this tax.
Pouches	--	Both directions	10 per day	600 OID	These pouches contain confidential material.
Restaurants	--	Ibrahim Khalil	4 in Ibrahim Khalil	350,000 OID per month	Income from this source comes from the rent of the restaurant premises. The lease-holders also have to pay for the rent of warehouses and additional land.
Parking	--	Ibrahim Khalil	1,000 capacity	25 OID per car	Built by KDP in 1998.



#### 3.5.4.4 The Socio-Economic Situation, 1991-1996

The economic situation of this period is most usefully seen as one of coming to terms with a unique set of conditions presented by the political environment. As well as coping with the impact of the *Anfal* Campaigns and the aftermath of the Iran-Iraq War, Iraqi Kurdistan was now under international and internal sanctions and isolated from the rest of the country. The internal political situation was unstable, with the internecine fighting breaking out several times during this period, with ferocious fighting taking place between the KDP and PUK.<sup>157</sup>

Agricultural inputs were among the first items to be embargoed by the Iraqis against the Kurds, inhibiting the ability of Kurds in the collective settlements to return to their villages.<sup>158</sup> The limited industrial base of Iraqi Kurdistan rapidly deteriorated and the cost of living substantially increased. Commodities which would normally have come from the rest of Iraq were now scarce. By October 1992, kerosene prices were 200 times higher than before 1990, and rice prices were 80 times higher.<sup>159</sup>

##### 3.5.4.4.1 *The International Aid Effort*

During the early 1990s, the economy of Iraqi Kurdistan received new impetus from a large-scale international aid effort. The impact of the programme is extremely difficult to ascertain, and is a source of confusion amongst agencies, the KRG, and the populace as a whole. Graham-Browne notes that "*the humanitarian crisis in northern Iraq in April and May 1991 had drama, pathos and media appeal. Its messy and protracted aftermath attracted less public attention and sympathy.*"<sup>160</sup> The beneficiaries of such confusion were political parties, the black market, UN personnel, and the GOI, which benefited from the leakage of hard currency and marketable items at the expense of the Iraqi Kurdish peoples.<sup>161</sup>

In April 1991, a Memorandum of Understanding (MOU) was signed between the UN and the GOI regarding humanitarian operations in Iraq. However, the GOI

---

<sup>157</sup> See Chapter 4 for a political analysis of this period.

<sup>158</sup> Keen (1993) *op. cit.*, p. 32.

<sup>159</sup> *Ibid.*

<sup>160</sup> Graham-Brown (1999) *Sanctioning Saddam: The Politics of Intervention in Iraq*. London: IB Taurus, p. 261.

<sup>161</sup> For a comprehensive analysis of the humanitarian aid programme in Iraqi Kurdistan since 1991, see Graham-Brown (1999) *op. cit.*, pp. 261-323.

secured firm control of the activities of international organization, to the extent that relief supplies had to be bought from Baghdad in hard currency at the official government rate.<sup>162</sup> Even though the UN targeted the northern governorates, by its own admission, supplies were inadequate, and rations suffered from seasonal fluctuations, often being reduced in the summer months.<sup>163</sup> The funding for UN operations in the 1991-1996 period came mostly from donor states and, although insufficient, the amounts raised were still considerable. During this period as a whole, a total of US\$ 670.7 million was spent in Iraq by the UN Inter-Agency Humanitarian Programme. Table 3.7 provides a breakdown of the resources distributed.

In addition to this sum, it is estimated that the NGOs channelled in approximately US\$ 400 million during the same period.<sup>164</sup> Of these sums, it is estimated that the US paid approximately US\$ 35 to 40 million per year to both UN agencies and NGOs.<sup>165</sup> The response from the European Union (EU) was similarly massive; with the European Community Humanitarian Organization (ECHO) contributing 21,500 million ECU in 1993 alone.<sup>166</sup> However, the effectiveness of these programmes was commonly called into question by political parties and the KRG alike, with allegations of corruptness and poor planning and targeting of assistance commonly mentioned. These sentiments are reflected by Jalal Talabani, who said that “*sums are gathered in the name of the Kurdish people and eaten by the bureaucratic bodies of the United Nations.*”<sup>167</sup>

#### 3.5.4.4.2 *The Agricultural Sector*

Heavily hit by the legacy of the previous fifteen years and the privation of double sanctions, the agricultural sector was one of the first to benefit from the influx of humanitarian aid which arrived in Iraqi Kurdistan upon the withdrawal of the GOI in October 1991. The rural infrastructure of the region was the first area to be addressed

<sup>162</sup> Leezenberg (1999) *op. cit.*, p. 9.

<sup>163</sup> *Ibid*, quoting Keen (1993) *op. cit.*

<sup>164</sup> Durham University Policy Planning Unit (1998) *op. cit.*, p. 10.

<sup>165</sup> Figures from Leezenberg (1999) *op. cit.*, p.11.

<sup>166</sup> *Ibid.*

<sup>167</sup> The Congress, 1 July 1993, interview with Jalal Talabani.



by many NGOs as it could engage a large workforce and relieve some of the pressure facing urban areas.<sup>168</sup>

**Table 3.7: Resources Channelled Through UN Agencies in Iraq (in US\$ million),  
1991-1996<sup>169</sup>**

<i>Agency</i>	1991	1992	1993	1994	1995	1996	Total
UNDHA	3.65	5.60	1.99	2.90	2.32	1.39	17.85
UNHCR	103.60	13.20	---	0.4	---	0.26	117.46
IOM	8.80	2.60	---	---	---	---	11.40
UNICEF	16.93	32.53	50.28	28.72	27.28	24.35	180.10
WFP	16.64	42.59	30.44	38.84	16.93	30.71	178.85
FAO	1.26	1.27	16.10	5.45	5.57	4.42	34.07
WHO	5.02	44.2	6.27	2.50	4.54	1.20	23.95
UNESCO	---	---	1.44	0.60	0.20	---	2.24
UNDP	---	---	1.00	---	0.60	---	1.60
UNGCI	21.18	39.19	15.62	14.16	7.37	2.51	100.03
UNV	1.80	1.10	0.30	---	---	---	3.20
<b>Total</b>	<b>178.88</b>	<b>142.50</b>	<b>123.4</b>	<b>93.57</b>	<b>67.51</b>	<b>64.84</b>	<b>670.70</b>

According to the Ministry of Reconstruction and Development of the KRG, 2,800 villages had been rebuilt by 1995.<sup>170</sup> However, the agricultural output of the region suffered under the sanctions regime, even though the area under cultivation increased during this period.<sup>171</sup> The ability of the humanitarian aid effort to resurrect the agricultural sector was nullified by the legacy of previous GOI actions from the 1970s and by the availability of cheap imports from Turkey, which the UN agencies were increasingly purchasing to meet the demands of supplying the food ration.<sup>172</sup>

<sup>168</sup> Overseas Fund for Disaster Aid. Figures from Leezenberg (1999) *op. cit.*, p.11.

<sup>169</sup> UNOHCI (1997) *Summary Report on Programme Funding*.

<sup>170</sup> Stichting Nederland-Koerdistan (1996) *op. cit.*, p. 20.

<sup>171</sup> Menichini (1996) *op. cit.*, p. 10.

<sup>172</sup> Leezenberg (1999) *op. cit.*, p.12.

The scale of the humanitarian assistance was not of a great enough magnitude and suffered from being too localised, and by the larger UN agencies being obstructed in their developmental efforts by the GOI. In addition, the areas which had suffered attacks with chemical weapons proved to be infertile in many cases, and the resumption of normal farming activities was further impeded by the presence of landmines.<sup>173</sup> This situation resulted in Kurds deserting the agricultural sector, and resorting to activities giving short-term gain, such as the selling of capital assets, smuggling, chopping down trees, and collecting scrap metal.<sup>174</sup> Furthermore, there was little incentive for the Kurdish population residing in the collective settlements to return to their lands.<sup>175</sup> Conditions within the urban areas of Iraqi Kurdistan deteriorated rapidly with the upheavals after the uprising and subsequent embargoes against the territory. According to UN sources, by mid-1995 there were an estimated 590,000 persons directly dependent on external food support, provided by the UN.<sup>176</sup>

#### 3.5.4.4.3 *Urban Unemployment and Underemployment*

Unemployment figures during this period were estimated to be between 70-80%, but could possibly have been higher. Those in public sector employment fared little better than the unemployed. The salaries of civil servants were approximately 200 OID (US\$ 6-16), and were little higher in 1997.<sup>177</sup> It was estimated by UNICEF that in order to meet the minimum standard of life in terms of provision of basic amenities, a sum of at least 1500-2000 OID (US\$ 50-65) would be needed to support a family of five persons.<sup>178</sup>

The situation in Iraqi Kurdistan by the mid-1990s was reaching critical levels. Monetary problems had reduced the purchasing power of the populace, and, according to the Overseas Development Administration (ODA) 1994 Household Expenditure Survey, 13% of the population had fallen below the poverty line, while

---

<sup>173</sup> Keen (1993) *op. cit.*, pp. 38-39, quoting the Mines Advisory Group (MAG), which estimates that there may be as much as 5-6 million mines in Iraqi Kurdistan, and especially located around the most productive land.

<sup>174</sup> *Ibid.*

<sup>175</sup> This deterioration resulted in a bad harvest in 1994, resulting in the food ration being reduced. UNICEF (1994) *Impact of Reduction in Food Ration*, p. 3.

<sup>176</sup> Leezenberg (1999) *op. cit.*, p. 12, quoting United Nations (1995a) *op. cit.*

<sup>177</sup> *Ibid.*; Durham University Policy Planning Unit (1997) *Inception Report*, Unpublished report for Department for International Development, London: p. 23.

<sup>178</sup> *Ibid.*



the poorest 10% of households earned only 3% of the average household expenditure.<sup>179</sup> The economic recession also affected greatly the swollen middle classes and those dependent on government salaries, producing a social malaise of unprecedented proportions across many socio-economic strata.

#### 3.5.4.5 The Socio-Economic Situation, 1996 Onwards

1996 was an eventful year for the Iraqi Kurdish region. The balance of power between the two dominant parties changed significantly in August, with the KDP capturing the city of Erbil with the assistance of the GOI. The administration of Iraqi Kurdistan was then divided between the KDP in Erbil and the PUK in Suleimaniyah, but with the PUK in a financially weak condition. There were also significant events occurring which would have an impact on the socio-economic condition of the north, and the situation of the agricultural base with the development and subsequent implementation of SCR 986, otherwise known as the oil-for-food deal.

Iraqi Kurdistan at least benefited from a period of reasonable political stability from the end of 1996 onwards, with only a brief round of fighting between the KDP and PUK occurring towards the end of 1997. The increased experience of both sets of administrations in Erbil and Suleimaniyah reaped dividends, and SCR 986 provided some relief, albeit by risking returning the Kurds to a culture of dependency.

##### 3.5.4.5.1 SCR 986

Due to mounting public pressure concerning the humanitarian crisis in Iraq, the Security Council proposed an oil-for-food agreement that would allow for some relief without reforming the comprehensive nature of SCR 661. This proposal was first suggested in SCR 687 and elaborated in SCRs 706 and 712 from August and September of 1991.<sup>180</sup> At this stage, it was envisaged that Iraq would be allowed to sell US\$ 3.2 billion of oil per year. This was well below what the UN had estimated the civilian needs to be, which was put at US\$ 22 billion. Furthermore, the plans place strict conditions on the delivery of imported items and reserved over 40% of the sum for such agencies as the Compensation Fund to Kuwait, the Boundary

---

<sup>179</sup> Ward & Rimmer (1994) *Targeting Basic Assistance in Northern Iraq: Findings from a Household Expenditure Survey*, Unpublished paper for DFID.

<sup>180</sup> *Ibid.*

Commission, and the International Atomic Energy Authority (IAEA). Iraq rejected these proposals as an infringement on its sovereignty.<sup>181</sup>

In April 1995 the Security Council proposed another oil-for-food deal with SCR 986, which allowed Iraq to sell up to two billion dollars worth of oil in a 180-day period.<sup>182</sup> This resolution was accepted after more than a year of delays by the GOI. An MOU was signed between the UN and the GOI in May 1996 organizing the details of the sale of oil, and establishing the necessary bank accounts.<sup>183</sup> Subsequent resolutions increased the amount of oil allowed to be sold to US\$ 5.2 billion, but due to the inadequacy of the Iraqi oil industry in the aftermath of the Second Gulf War, it was not able to pump this amount. The ceiling was lifted in 1999, with revenue generated during phase VIII of the programme, in 2000, projected to be close to US\$ 10 billion.<sup>184</sup>

Table 3.8 details the volume and value of the oil exported to mid-October 2000. From this initial amount of US\$ 2 billion every 6 months, the northern governorates of Iraqi Kurdistan were allocated 13% (US\$ 260 million) for the purchase of humanitarian supplies to be distributed by the agencies of the UN. This amount was divided between the governorates according to population size, with Suleimaniyah Governorate receiving 43%, Erbil Governorate receiving 34%, and Dohuk Governorate receiving 23%. As the MOU of 1996 was signed between the GOI and the UN, Darbandikhan Governorate was not recognised as a separate entity and was instead included as part of Suleimaniyah Governorate.

Furthermore, as the GOI did not recognise the local Kurdish authorities administering the northern governorates as being legitimate offices of the GOI, they were not included in the procedures of implementation of SCR 986. The UN, rather than the Kurdish authorities, was therefore left with the job of administering the programme and distributing the supplies in Iraqi Kurdistan. This contrasts with what happens in the centre and south of the country, where ministries and departments of

---

<sup>181</sup> *Ibid.*

<sup>182</sup> UN Office of the Iraq Programme (2000) *Oil-for-Food: The Basic Facts, 1996-2000*.

<sup>183</sup> Proceeds from the sales are deposited in a UN controlled Escrow account at the Banque Nationale de Paris.

<sup>184</sup> UN Office of the Iraq Programme (2000) *op. cit.*



the GOI wholly distribute the supplies, with the UN agencies acting in an observation capacity.

**Table 3.8: SCR 986 Series Revenue<sup>185</sup>**

Phase	SCR	Date	Volume of oil (millions of barrels)	Value of exports (US\$ million)	Price per barrel (\$)
One	986	14.4.95	120	2,150	17.92
Two	1111	4.6.97	127	2,125	16.73
Three	1143	4.12.97	182	2,085	11.46
Four	1153	20.2.98	308	3,027	09.83
Five	1210	24.11.98	360.8	3,947	10.94
Six	1242	21.5.99	389.6	7,402	19.00
Seven	1281	10.12.99	343.4	8,285	24.13
Eight	1302	8.6.00	263.1	6,730	25.57
<b>Total</b>			<b>2,093.9</b>	<b>35,751</b>	<b>Av=17.07</b>

Up until mid-October 2000, according to the UN Office of the Iraq Programme, a total of US\$ 35.751 billion had been generated by the oil-for-food programme since SCR 986. Of this, the 13% of the three northern governorates amounts to US\$ 4.648 billion. The amounts now being circulated within Iraqi Kurdistan by the agencies of the UN are huge and, whilst SCR 986 has undoubtedly averted a serious humanitarian catastrophe, the provision of revenue on this scale is creating serious structural problems for the Iraqi Kurdish economy and the sustainable development of the KRG. The impact of SCR 986 will be addressed in more detail in Chapter 7. However, in brief, the actions of the UN Security Council are promoting the development of dependency upon an external source of revenue within the Kurdish regions of Iraq, both within the KRG and the population at large.

<sup>185</sup> Source: UN Office of the Iraq Programme.

### 3.5.4.5.2 *The Agricultural Sector*

Prior to the embargo of 1991, the availability of subsidised food and public service employment opportunities in a variety of sectors not only encouraged the urbanisation process but also rendered employment in agricultural production unattractive. This situation changed after the introduction of the economic embargo. Agricultural production played a vital role in attaining some measure of food security in the northern governorates. The deterioration of the public food rationing system and limited coverage of international food aid compelled the entire rural, and a majority of the urban population, to depend to a greater degree on local food production.

This demand resulted in a favourable economic climate for agricultural production and encouraged agricultural expansion. The majority of the population had, at some time, been engaged in food production, including those residing in collective towns. Many urban families possessed land and would either travel to their fields and stay in temporary accommodation, or rent the land to others.

By 1990, food importation ceased and Iraq came to rely on domestic food production which clearly did not meet the entire needs of the population. To encourage local production of food, the GOI increased the price of cash crops significantly. Thus, between 1990 and 1993, the price of wheat per ton doubled from 500 OI to 1,000 OI due to high local demand and the discontinuation of subsidised imports from the GOI.<sup>186</sup> This in turn resulted in an increase in wheat and barley production during these years.

However, this promising picture was weakened in the mid-1990s. Upon the discussion of the SCR 986, increasing land disputes, and internecine fighting, there was a decrease in the total cultivated area, yield, and production of wheat. Based on estimates of the Food and Agriculture Organization (FAO), wheat production declined from its 1993 level of 500,151 tons to approximately 312,318 tons in 1996, a figure also supported by ODA crop units working in the region.

---

<sup>186</sup> Source: FAO/Iraq Reports (1996); Leezenberg (1999) *op. cit.*, p. 11.



By June 1996, two important factors were influencing the agricultural sector in Iraqi Kurdistan; poor rainfall in the growing season, and the anticipated implementation of SCR 986. The news of Iraq's agreement to the latter in February of 1996 created expectations of large inflows of humanitarian supplies into Northern Iraq. As a result the OI appreciated in value and food prices fell dramatically, consequently depreciating the price of wheat. The drastic decline of wheat production was the conscious decision on the part of the farmers not to cultivate wheat. With the publicity surrounding the implementation of SCR 986, a price reduction of locally produced wheat was fully anticipated. A Dutch NGO noted at the time that "*the announcement of a 'oil-for-food' deal between the UN and Iraq in May 1996 sent shockwaves through the regional economy.*"<sup>187</sup>

Low wheat prices affected all agricultural output prices (as most foods became substitutes for the staple, wheat), while cost of non-labour inputs (i.e. fertilisers, seeds, pesticides, ploughing, vaccinations) remained relatively stable and the margin of profit that farmers expected on each donum of land planted or animal effectively fell. Thus, the incentive to produce declined. This is reflected in Table 3.9, showing the area under wheat before and after the imposition of the 986 programme.<sup>188</sup>

**Table 3.9: Total area Under Wheat in Donums for 1994-97**<sup>189</sup>

<i>Year (total for all three governorates)</i>	<i>Area (in Donums)</i>
1994/95	2,254,954
1995/96	1,823,102
1996/97	1,453,394

The agricultural situation at the end of the 1990s is confusing. Reports from agencies in Iraqi Kurdistan claim that agricultural production is again rising. However, the causes of the decline have still not been remedied, and it is difficult to imagine how the agricultural sector could enjoy a significant recovery without these issues being addressed. The situation of agriculture has been further hit by drought over two

<sup>187</sup> Stichting Nederland-Koerdistan (1996) *op. cit.*, p. 19.

<sup>188</sup> See Stansfield (2000b) *op. cit.*,

consecutive years, 1999-2000, and this has resulted in wholesale change of agricultural activities.

#### 3.5.4.5.3 *The Informal Sector*

During this period of reduced central government authority in Iraqi Kurdistan, the (private) informal sector of the economy has flourished, particularly by providing hitherto abundant consumer items.<sup>190</sup> Many Kurds resorted to, or expanded, smuggling operations, with the largest smuggling sector being to transport Iraqi petrol to Turkey. This activity formed a major source of income for the political parties of Kurdistan, for the KRG, and for the political elite of Iraq.<sup>191</sup> As seen, it is estimated that customs levies at the Iraqi Kurdish–Turkish border at Ibrhahim Khalil amounts to at least several tens of thousand dollars per day.<sup>192</sup>

These sources of income of the political parties of Iraqi Kurdistan are much debated and pose a serious problem for the conciliation of the KDP and PUK. The positioning of the main crossing point into Iraqi Kurdistan between Iraq and Turkey in KDP territory has resulted in a skewing of resources between the KDP and PUK region, to the extent that it may be identified as one of the primary causes of conflict between the two parties. According to the PUK, the revenue generated by the KDP at Ibrahim Khalil amounts to some 4 million OID daily (approximately US\$ 200,000).<sup>193</sup>

A further flourishing informal sector is in the smuggling of peoples out of Iraqi Kurdistan. Since 1991, large numbers of people have fled the region, mainly to Western Europe, but also to Australia and North America.<sup>194</sup> Initially, the more affluent members of society were attempting to leave, but it is now common to find poorer families attempting to save the required sums to ensure that members of their family can emigrate. The most worrying economic impact of this emigration is that

---

<sup>189</sup> Source: FAO (Erbil): February 1998.

<sup>190</sup> Leezenberg questions whether such activity can be classified as 'illegal' as there was initially no adequately functioning state apparatus to define the legal economy. Leezenberg (1999) *op. cit.*, pp. 15-16.

<sup>191</sup> *Ibid.*

<sup>192</sup> *Ibid.*

<sup>193</sup> PUK Foreign Relations Bureau document provided by Shwan Qliasani, September 1999.

<sup>194</sup> *Ibid.*; Stansfield (2000c) "A Qualitative Description and Analysis of Male Potential Asylum Seekers from Erbil (Northern Iraq)" in Efiionayi-Mäder, *et. al.*, (eds.), *Distribution of Asylum Requests Over European Countries*. Neuchâtel: Schweizerisches Forum für Migrationsstudien.



Kurdistan is losing its most highly qualified professional people from the educated middle class, creating a brain-drain with long-term consequences.<sup>195</sup>

### 3.5.5 Conclusion

Iraqi Kurdistan, in terms of its economic development in particular, and also in terms of its geography and population characteristics, is being forced into major changes, mostly for the worse in the short term. The activities of successive GOI policies and humanitarian aid inputs in the 1990s has succeeded in weakening the agricultural basis of Iraqi Kurdistan, and making a society which has the capability and resources to enjoy a reasonable degree of self-sufficiency dependent on external sources for all provisions, including food and everyday consumer items.

In this depressed scenario of a weakened agricultural structure, mass unemployment, and dependency on imports, the informal sector has flourished, making a few people extremely wealthy and channelling significant funds to the political parties of Kurdistan and the KRG, amongst others. This has resulted in an extremely vibrant informal sector, creating an uneasy dichotomy in Iraqi Kurdistan between the majority who are destitute, and a minority of merchants who are extremely wealthy.

---

<sup>195</sup> Leezenberg (1999) *op. cit.*, p. 17.

## Chapter 4

### The Development of the Party Political System

#### 4.1 Introduction

Organized political groupings in Iraqi Kurdistan have been a powerful variable in the dynamics of the region since the foundation of the KDP in 1946, and this has especially been the case in the 1990s. The withdrawal of the GOI in 1991 from Iraqi Kurdistan gave an opportunity to the principal political groupings to present themselves as organizations capable of mobilizing widespread popular support, military personnel, foreign national support, and substantial financial resources. In effect, they were presented with the opportunity to behave as political parties rather than guerrilla movements. The political system in Iraqi Kurdistan displays bewildering complexity and possesses parties of considerable sophistication. Much has been written on Kurdish political history, yet the internal aspects of the organizational structures and decision-making processes of the parties have rarely been addressed. Without such an understanding, it is impossible to appreciate fully the political system.<sup>1</sup>

#### 4.1.1 Aims

These aims of this chapter can be summarized as follows:

1. To assess the development of the party political system, focusing on the transition of the organizational structure and personnel from guerrilla movements and *peshmerga* to political parties and politicians respectively.
2. To identify the development of power groupings within the principal political parties for their impact upon the overall decision-making process.

#### 4.1.2 Methodology and Structure

The structure of the analysis is chronologically based. This is of particular use as the foundations of many of the parties have roots in other parties. The analysis is

---

<sup>1</sup> Natali makes a similar statement when she urges the need to understand the internal conflict in more detail. (Natali (1999) *op. cit.*)



weighted towards the internal rather than external dimensions, illustrating: (a) how the main political actors and groupings formed; (b) the main tensions, alliances, and mechanics of Kurdish politics in Iraq, and; (c) analyses of key events, when necessary, to provide further understanding. The chapter is concluded with an assessment of the situation of the parties on the eve of the Second Gulf War.

## **4.2 The Origins of the Party Political System**

The political system of Iraqi Kurdistan has its origins in the feverish state-building which characterised the Middle East in the aftermath of World War One. After failing to secure a nation-state of their own in the Treaty of Lausanne, the Kurds found themselves divided between the states they are in today. Kurdish rebellions, whether tribal or nationalist, became commonplace in Iraq, Iran and Turkey, with all of them being successfully repressed. Military attacks by state authorities against the Kurds were combined with policies of assimilation and/or dispersion in an attempt to weaken the Kurdish nationalist movement.<sup>2</sup>

### **4.2.1 The Kurdish Democratic Party**

Within Iraq, the most important event in the development of the Kurdish political system was the foundation of the Kurdish Democratic Party in 1946. Many aspects of the contemporary situation in Iraqi Kurdistan can be traced, both in structural and ideological terms, to the establishment of this party as it is from the Kurdish Democratic Party that the origins of the contemporary KDP and PUK can be traced. The following sections describe and analyse the formation of the early KDP, the influences surrounding its creation, and identifies those tensions which resulted in the establishment of the PUK.

The origins of the KDP are complex and are the result of several political conditions. These conditions will be studied with reference to three dynamics:

1. Tribal militancy in Iraq, Iran and Turkey;
2. The development of an urban Kurdish intelligentsia in Iraq and Iraqi Kurdistan promoting Kurdish nationalism. The formation of the

---

<sup>2</sup> Bruinessen (1992a) *op. cit.*, pp. 25-26.

Kurdistan Democratic Party in Iran (KDP-I) and attempts at state-building in Iranian Kurdistan.

3. The role of the Barzani tribe, and particularly Mulla Mustafa Barzani.

The following discussion centres on the period immediately before the 1950s and includes those events and dynamics which had a key influence in the establishment of the Kurdish Democratic Party. An assessment of the role of Barzani is included in each section in an attempt to investigate his role as a key linking character. Figure 4.1 charts the principal political events of the pre-1960 period which had an impact upon the genesis of the KDP, emphasising the interrelationships between developments in Iraq and Iran.<sup>3</sup>

#### 4.2.1.1 The Role of Tribal Militancy

The role of tribal militancy has had a great impact upon the development of the Kurdish political system. Kurdish revolts are best viewed as a balance between tribal and nationalist interests. The earlier revolts were instigated primarily to benefit the interests of particular tribes, with later ones increasingly adopting a more nationalist tone. It is this change in emphasis which is of prime importance in this section, as it sees the broadening of the Kurdish issue in Iraq, and the mutually antipathetic tendencies of tribalism and nationalism manifest themselves into irreconcilable political structures and decision-making processes. The commencement of tribal uprisings can be traced to the activities of Sheikh Ubayd Allah from 1878 onwards.<sup>4</sup> From then on, various tribal revolts took place in Kurdistan, with the focus remaining tribal rather than national, with many urban-based nationalist groupings refusing to aid the tribes' uprisings, and many tribal leaders not wanting to receive their support.<sup>5</sup>

---

<sup>3</sup> Sources employed include: Arfa (1966) *op. cit.*; Zaid (1970) "The Role of the KDP in the Kurdish Revolution." *Kurdistan* 14, 1970, (The Annual Journal of the Kurdish Students Society in Europe - KSSE), pp. 7-10, p. 7; Roosevelt (1978) "The Kurdish Republic of Mahabad," in Chaliand, (ed.), 1993, pp. 122-128; Vanly (1980) *op. cit.*; Ghassemlou (1965) *op. cit.*; McDowall (1996) *op. cit.*, pp. 237-246 & 288-297; O'Ballance (1996) *The Kurdish Struggle, 1920 - 1994*, London: Macmillan Press, pp. 12-35; Ghafour (1997) *The Longest Revolution: The Kurdish Chrono-Political History*. London: Avon Books, pp. 2-9.

<sup>4</sup> For further details on Sheikh Ubayd Allah, see McDowall (1989) *The Kurds*. London: Minority Rights Group, pp. 10-11; (1996) *op. cit.*, pp. 53-59; O'Ballance (1996) *op. cit.*, pp. 7-9.

<sup>5</sup> See Arfa (1966) *op. cit.*, p. 129; O'Ballance (1996) *op. cit.*, p. 15.



**Figure 4.1: The Origins of the KDP**

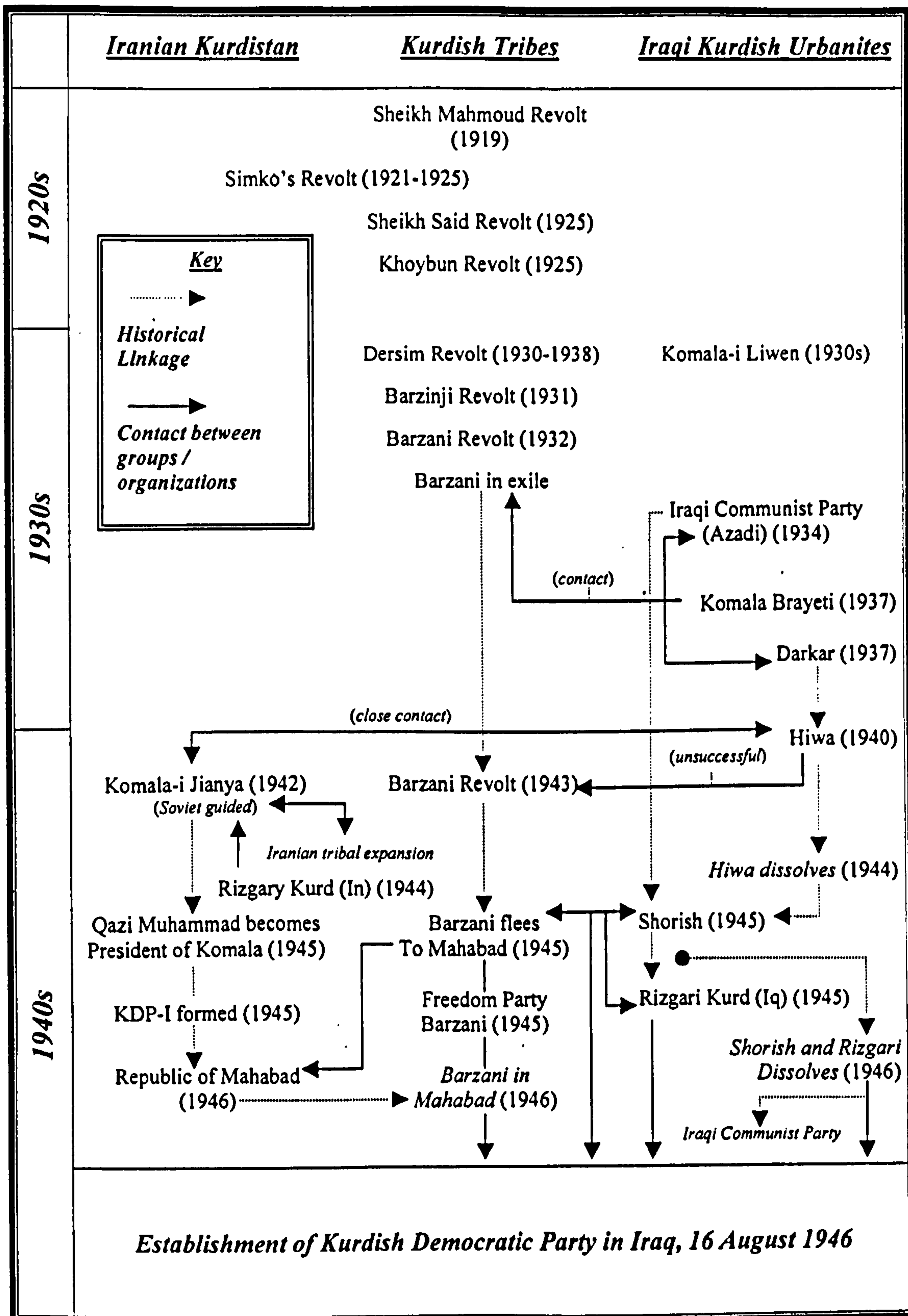

The major revolts of this period (Sheikh Said, Khoybun, Simko Uprising, Dersim, and the Barzinja and Barzani Revolts) are all characterised by tribal aims and support, with little, if any, thought for Kurdish nationalism, or for alliance with the urban-based nationalists in Iran and Iraq.<sup>6</sup> If nationalism became part of these struggles, it was usually as a means of mobilizing support for the benefit of the tribal rebellion. Ghareeb emphasises this balance when he states that “*Kurdish rebellions . . . [were] motivated by personal ambition as well as nationalism to block the central authority's control over [the] region.*”<sup>7</sup>

This balance between tribal and personal interests on the one hand, and the use of nationalism as a motivating force can be seen by studying two of the greatest revolts and Kurdish leaders – the first revolt of Sheikh Mahmoud Barzinja in 1919, and Barzani’s revolt of 1943.

#### 4.2.1.1.1 *The Rebellion of Shiekh Mahmoud Barzinja*

Sheikh Mahmoud had enjoyed a somewhat turbulent political career throughout World War One. His pro-British actions saw him almost achieve the establishment of a KRG based in Suleimaniyah.<sup>8</sup> However, his relationship with the British degenerated when he became more vociferous in demanding an independent Kurdish state. Sheikh Mahmoud proclaimed independence in May 1919 but, after fierce fighting, his rebellion was defeated and he was imprisoned. The independent Kurdish state did not materialise, and the region was incorporated by the British into the Republic of Iraq.<sup>9</sup>

While it may seem that Sheikh Mahmoud’s tendencies were nationalist, he had little in common with the nationalist movement. In discussing the balance between tribalism and nationalism, McDowall points out that:

*“It is tempting retrospectively to clothe Shaykh Mahmud in the garb of modern nationalist ideas . . . . It is significant that [he] did not waste his time appealing to nationalist sentiment . . . . Furthermore, his style was to use kin and tribal allies and his aim was the establishment of a*

<sup>6</sup> For an in-depth analysis of these revolts, see Jwaideh (1960) *op. cit.*

<sup>7</sup> Ghareeb (1981) *The Kurdish Question in Iraq*. New York: Syracuse University Press, p. 11.

<sup>8</sup> Jwaideh (1960) *op. cit.*, pp. 480-482; Arfa (1966) *op. cit.*, pp. 111-112; Gunter (1993) *op. cit.*, p. 3; McDowall (1996) *op. cit.*, p. 156.

<sup>9</sup> For details about the rebellion of Sheikh Mahmud Barzinja, see Jwaideh (1960) *op. cit.*, pp. 516-535.



*personal fiefdom. Shaykh Mahmud offered Kurds liberation from British rule, but not from himself.”*<sup>10</sup>

#### 4.2.1.1.2 *The 1943 Revolt of Barzani*

After previous rebellions, Barzani was kept in detention in Nasiriya in southern Iraq, and then later in Suleimaniyah.<sup>11</sup> In 1943 he escaped and fled to Barzan with the assistance of the nationalist party *Hiwa*<sup>12</sup> and mobilised his followers to prepare to revolt.<sup>13</sup> The main demands of Barzani were that an autonomous province consisting of Kirkuk, Suleimaniyah, Erbil, Dohuk and Khanaqin should be created and placed under a Minister for Kurdish Affairs. Upon the rejection of these demands, fighting broke out.<sup>14</sup> The revolt was crushed by the Iraqi army in collaboration with various Kurdish tribes, and Barzani was forced into exile into Iran and fled to Mahabad with some 3,000 fighters.<sup>15</sup>

Whether Barzani's 1943 rebellion could be called nationalist is debatable. Sivan suggests that the rebellion marked a new phase in the Kurdish struggle in Iraq, and;

*“Unlike previous revolts which were primordially tribal, this outburst was essentially nationalistic. Not only did Barzani himself declare the national aims of the rebellion, but for the first time the urban nuclei of the national movement joined the struggle, conferring a new dimension upon it.”*<sup>16</sup>

Arfa agrees with this, and compares Barzani's revolt with that of Sheikh Mahmud;

*“The successive rebellions of Shaikh Mahmud of Suleimaniyah had been local movements with the autonomy of a Kurd-inhabited region in view, but in 1945 for the first time a co-ordinated action by a*

<sup>10</sup> Morris holds a similar opinion to McDowall, describing the tribal leaders of the time as “being interested in protecting their own quasi-feudal interests rather than combining in support of anything approaching a Kurdish national cause”. McDowall (1996) *op. cit.*, p. 158; Morris (1999) *op. cit.*, p. 45.

<sup>11</sup> McDowall (1996) *op. cit.*, p. 290.

<sup>12</sup> Gunter (1993) *op. cit.*, p. 9; For details of the escape of Barzani from Suleimaniyah, see Amin (1999) *Khowlanawa la Nawbaznada: Diwa Nawaway Rowdawakany Kurdistan Iraq, 1984-1998*. Berlin: Awadani e.V.

<sup>13</sup> Arfa (1966) *op. cit.*, p. 119; Ghareeb (1981) *op. cit.*, p. 33.

<sup>14</sup> Gunter (1993) *op. cit.*, p. 9.

<sup>15</sup> For details on the Barzani rebellion of 1943, see Jwaideh (1960) *op. cit.*, pp. 671-707; Farouk-Sluglett & Sluglett (1987) *Iraq Since 1958: From Revolution to Dictatorship*. London: I.B. Taurus, pp. 28-29.

<sup>16</sup> Sivan (1975) “The Kurds: Another Perspective,” *Case Studies on Human Rights and Fundamental Freedoms: A World Survey*, Vol. 2. The Hague: Martinus Nijhoff, p. 147.

*Kurdish nationalist party with tribal and religious leaders had been undertaken.”*<sup>17</sup>

Conversely, McDowall points out that, although sometimes described as a nationalist rebellion, the evidence is contrary to this;<sup>18</sup>

*“Although sometimes described as a nationalist rebellion, the evidence indicated that it was not . . . . There is little solid evidence that Barzani has espoused the Kurdish cause during the course of his revolt . . . . If one looks at his actions . . it is plausible that . . like any good tribal leader, he was constantly seeking to widen his regional authority.”*<sup>19</sup>

While it is difficult to place the motivation of this rebellion, it would appear to be the case that if Barzani did not choose nationalism, the nationalists chose him.<sup>20</sup> Perhaps the most useful way to view the historical significance of the Barzani rebellion of 1943 is that of a watershed in Kurdish politics. The 1943 revolt is the last time that tribal elements exploit nationalism with no opposition. From 1943 onwards, it is increasingly apparent that the nationalists are less inclined to be used as pawns in tribal politics, and attempt to exploit tribalism for their own agenda. This conflict between the two groups has become a characteristic of Kurdish politics ever since.

#### 4.2.1.2 The Rise of Nationalist Groups

The early focus of the rise of Kurdish nationalism was in Iran. It is therefore necessary to commence with a brief account of events in Iran which culminated in the establishment of the Mahabad Republic.

##### 4.2.1.2.1 The Republic of Mahabad

During the period of the Second World War, the focus of Kurdish national aspirations was in the city of Mahabad in Iranian Kurdistan.<sup>21</sup> Facilitated by a weakened central government and a benevolent attitude on the part of Soviet forces occupying Azerbaijan, the Kurds of Mahabad declared an independent republic in

---

<sup>17</sup> Arfa (1966) *op. cit.*, p. 129.

<sup>18</sup> McDowall (1996) *op. cit.*, p. 290.

<sup>19</sup> *Ibid*, pp. 290-293.

<sup>20</sup> *Ibid*, p. 293.

<sup>21</sup> For detailed accounts of the Republic of Mahabad, see Roosevelt (1947) *op. cit.*, and Eagleton (1963) *The Kurdish Republic of 1946*. London: Oxford University Press.



1946.<sup>22</sup> Iraqi Kurds, including Barzani and his militia, supported the fledgling Kurdish entity. The Republic of Mahabad only lasted for as long as the Soviet forces were present in Iran, and once they evacuated Mahabad fell to the Iranian army.<sup>23</sup> Barzani escaped to Iraq, whereas the Iranian Kurdish leaders of the republic, including Qazi Muhammad, were captured and hanged.<sup>24</sup> The KDP-I fell apart, leaving a small clandestine rump with little influence. Barzani, facing difficulties in Iraqi Kurdistan, was forced to evacuate to the USSR where he was to stay for the next eleven years.<sup>25</sup> In the next decade, Kurdish nationalism appeared to have weakened in favour of class-based politics. However, unrest became increasingly apparent in Iraqi and Iranian Kurdistan between Kurdish peasants and landlords, and the 1960s witnessed a re-emergence of Kurdish nationalism.<sup>26</sup>

#### 4.2.1.2.2 *The Rise of Kurdish Nationalism in Iraqi Kurdistan*

Within Iraq, there was a waking of national consciousness among the first generation of secular educated and urban Kurds.<sup>27</sup> Informal groupings, such as *Komala-i Liwen* (Young Men's Organization), formed amongst the young urban Kurds in Baghdad, but, in the absence of any recognised Kurdish nationalist party, many joined the Iraqi Communist Party (ICP) when it formed in 1934.<sup>28</sup> Following the *coup d'etat* by Bakr Sidqi, and subsequent anti-Kurdish feeling amongst Arab Iraqis, more radical clandestine Kurdish nationalist groups began to form such as *Komala Brayeti* (Brotherhood Organization), and *Darkar* (the Woodcutters) in Suleimaniyah. *Darkar* had strong links with the ICP's Kurdish wing, but soon fell into disagreement through its overt promotion of Kurdish rather than Iraqi nationalism.<sup>29</sup> It is

<sup>22</sup> The Kurdish flag was raised in Mahabad on the 7 December 1945 and the republic was proclaimed on 23 January 1946 under the presidency of Qazi Muhammad (Ghafour (1997) *op. cit.*, p. 7).

<sup>23</sup> Pelletiere suggests that the withdrawal of Soviet forces from Mahabad, which resulted in the collapse of the Kurdish republic, was due to strong pressure being exerted by the United States which included President Truman allegedly threatening to use nuclear weapons if the Soviets did not withdraw. This incident is cited by some scholars as beginning the Cold War (Pelletiere (1991) *op. cit.*, pp. 4-5, p. 29).

<sup>24</sup> Qazi Muhammad was arrested on 17 December 1946 and hanged on 31 March 1947 (Ghafour (1997) *op. cit.*, p. 9).

<sup>25</sup> Bruinssen (1992a) *op. cit.*, p. 26. For sources on the Mahabad Republic, see: Jwaideh (1960) *op. cit.*, p. 709; Eagleton (1963) *op. cit.*; Roosevelt (1978) *op. cit.*; Kutschera (1979) *Le Mouvement National Kurde*, Paris: Flammarion: p. 153; Barzani's formation crossed into Soviet territory on 16 June 1947 (Ghafour (1997) *op. cit.*, p. 10).

<sup>26</sup> Bruinssen (1992) *op. cit.*, p. 26.

<sup>27</sup> McDowall (1996) *op. cit.*, p. 288.

<sup>28</sup> Gunter (1993) *op. cit.*

<sup>29</sup> McDowall (1996) *op. cit.*, p. 288.

interesting to note that these leftist groupings were forming mainly in Suleimaniyah rather than Erbil, a situation which has proven to be a constant in Iraqi Kurdish politics.

From *Darkar*, a new more populist party formed named *Hiwa* (Hope), which was intended to solidify Kurdish nationalist sentiment. This party, led by Rafiq Hilmi, was first organized in Kirkuk and spread throughout north and central Iraq.<sup>30</sup> It was initially secret and was comprised of Kurdish intellectuals and GOI civil servants. The aims of *Hiwa*, centered on the provision of autonomy for the Kurdish region of Iraq, were distinctly nationalist, although the organization was leftist-minded with members being influenced by communist doctrines.<sup>31</sup> With this ideology was combined a distinctly urban support basis with initial centres of organization being located in Erbil, Kirkuk, Kifri, Kalar and Khanaqin, as well as in Baghdad, and well away from the tribally-dominated areas.<sup>32</sup>

Whilst being a leftist party, *Hiwa* was politically astute enough to recognise the inherent strength of the tribes.<sup>33</sup> As such, it recognised Barzani as the leader of the Kurdish national movement, probably before he realised it himself, but remained suspicious of his tribal attitude. It is likely that *Hiwa* saw Barzani as a vehicle for the nationalist cause, and intended to discard him once the objective of autonomy was obtained.<sup>34</sup>

It is his relationship with *Hiwa* which possibly promoted the idea of the nationalist cause to Barzani. Upon receiving support from *Hiwa*, Barzani established his own nationalist-orientated party named '*Freedom*', which was composed mainly of Iraqi army personnel and liberal professionals, with few tribal cadres. Barzani also poached key personnel from *Hiwa* who were to play an invaluable part in the establishment of the Mahabad Republic.<sup>35</sup>

---

<sup>30</sup> Sheikmous (1999) *op. cit.*, p. 53.

<sup>31</sup> Arfa (1966) *op. cit.*, p. 123.

<sup>32</sup> *Ibid.*, p. 120; McDowall (1996) *op. cit.*, p. 288.

<sup>33</sup> Amin (1999) *op. cit.*

<sup>34</sup> Arfa (1966) *op. cit.*, p. 123.

<sup>35</sup> *Ibid.*



The delicate relationship between the tribal chiefs and the developing urban intelligentsia has to be seen as a key part of the progression of the nationalist thinking of Barzani. The division between those who saw this as the development of nationalist thinking for the sake of the Kurds, and those who saw it as a tool to strengthen the Barzanis would create a schism which is still apparent today.

#### 4.2.1.2.3 *Links Between the Iraqi Kurds and Mahabad*

*Hiwa* and *Darkar* both developed links with the Iranian Kurdish nationalists in Mahabad. Those present at meetings in 1942, in Mahabad, included mostly educated urbanites.<sup>36</sup> The meetings were encouraged by the USSR which had decided to sponsor the formation of a Kurdish organization in Iran.<sup>37</sup> Those regularly present at the meetings constituted themselves as a committee, under the name of *Komala i Jianawa i Kurd*, otherwise known as *Komala*.<sup>38</sup> *Komala* was divided into self-contained cells and members were aware only of the identities of members of their own cells, a system which lasted until recently in Iraqi Kurdistan.<sup>39</sup> *Komala* cells were widespread and units were founded in the Iraqi Kurdish towns of Kirkuk, Erbil, Suleimaniyah, Rowanduz and Shaqlawa.<sup>40</sup> The *Komala* leadership even developed ties with tribal sheikhs, thereby crossing the urban-tribal divide.<sup>41</sup> However, the relationship between the two groups was not necessarily straightforward. McDowall notes that;

“ . . . . most Aghas around Mahabad were attracted to *Komala* in spite of its class rhetoric, presumably because it symbolized independence from central government . . . . this did not imply solid support . . . . the chiefs were notorious for their mercurial politics.”<sup>42</sup>

Within six months *Komala* had 100 members, and in April 1945 Qazi Mohammad, the dominant political character of Mahabad, joined the party and was admitted as

<sup>36</sup> McDowall (1996) *op. cit.*, p. 237.

<sup>37</sup> O'Ballance (1996) *op. cit.*, p. 22.

<sup>38</sup> Zaid (1970) *op. cit.*, p. 7; O'Ballance (1973) *The Kurdish Revolt: 1961-1970*. Faber & Faber, London: p. 41; Ghareeb (1981) *op. cit.*, pp. 11-12; Ghafour (1997) *op. cit.*, p. 3. *Komala i Jianawa i Kurd* translates into 'Kurdish Revival Organization'. Ghareeb states that *Hiwa* merged with rather than was subsumed by *Komala* (p. 12). It should be noted that the name "*Komala*" became a common political term in Kurdistan, and this grouping should not be confused with the subsequent Iraqi Kurdish *Komala* which became part of the PUK.

<sup>39</sup> Entessar (1992) *op. cit.*, p. 17; McDowall (1996) *op. cit.*, p. 237.

<sup>40</sup> Roosevelt (1978) *op. cit.*, p. 123.

<sup>41</sup> O'Ballance (1996) *op. cit.*, p. 25.

<sup>42</sup> McDowall (1996) *op. cit.*, p. 239.

President.<sup>43</sup> Qazi Mohammad was a religious leader who could enhance the cooperation between leftist nationalists and the tribes.<sup>44</sup> *Komala* grew as a political party and, in November 1945, Qazi Muhammad convened a meeting at which the KDP-I was established, effectively absorbing *Komala* into it.<sup>45</sup> The KDP-I had nationalist aims including the use of the Kurdish language, self-government in domestic affairs, and the formation of a provisional council of Kurdistan.

#### 4.2.1.2.4 *The Union of Nationalism and Tribalism*

Within Iraqi Kurdistan, the preserve of Kurdish nationalism was increasingly under the influence of Barzani who, in January 1945, sent a delegation to the GOI, *Hiwa*, and the British Ambassador asking for the immediate implementation of autonomy.<sup>46</sup> As well as attempting to seize the diplomatic initiative, divisions occurring amongst the nationalist parties provided Barzani with an opportunity to utilise nationalism and further bridle the power of nationalist sentiment. *Hiwa*, which had attempted to become involved with the Barzani Revolt, dissolved after Barzani's exile, and within the vacuum a number of small political groupings formed.<sup>47</sup> Of these, *Shorish* (Revolution) was the most important, and from it developed the popular *Rizgari Kurd* (Kurdish Liberation) in 1945.<sup>48</sup> The increased popularity of these parties espousing Kurdish nationalism created tensions between the ICP and *Shorish* and *Rizgari Kurd*, and, by 1946, Suleimaniyah had become the scene of unrest.<sup>49</sup> However, through increasing pressure from the British and the GOI, both *Shorish* and *Rizgari Kurd* dissolved themselves in August 1946.<sup>50</sup>

Meanwhile, Barzani had decided to form a political party in Iraqi Kurdistan. He sent a member of *Shorish*, Hamza Abdullah to Iraq from Mahabad with a letter to the Iraqi Kurdish tribes proposing the formation of an Iraqi Kurdish Democratic Party. Qazi Muhammad was against the formation of such an organization in Iraq, saying

---

<sup>43</sup> Entessar (1992) *op. cit.*, p. 18; McDowall (1996) *op. cit.*, p. 239; O'Ballance (1996) *op. cit.*, pp. 25-26.

<sup>44</sup> Entessar (1992) *op. cit.*, p. 18.

<sup>45</sup> Roosevelt (1978) *op. cit.*, p. 128.

<sup>46</sup> Arfa (1966) *op. cit.*, p. 123.

<sup>47</sup> Jwaideh (1960) *op. cit.*, p. 794.

<sup>48</sup> McDowall (1996) *op. cit.*, p. 294.

<sup>49</sup> *Ibid.*, p. 295.

<sup>50</sup> *Ibid.*



"there is to be only one party, and you must not operate separately from it."<sup>51</sup>

However, Barzani continued with his plans. It appears by now he understood that, for a Kurdish movement to succeed, the tribes needed to work with the educated urban political parties, along the lines of the KDP-I. *Shorish* and *Rizgari Kurd* both dissolved themselves, with some members going to the proposed KDP of Barzani, and some joining the ICP. There was also tension between the planned new Iraqi Kurdish entity and the KDP-I, which had branches in Iraqi Kurdistan under the leadership of Ibrahim Ahmed who refused to join the new group without the express permission of Qazi Muhammad.<sup>52</sup>

#### 4.2.1.3 The Establishment of the Kurdish Democratic Party

The new Kurdish Democratic Party held its first congress in Baghdad on 16 August 1946. The 32 delegates elected a Central Committee with Hamza Abdullah as Secretary-General, Barzani as President-in-exile, and Sheikh Latif and Ziyad Agha as Vice-Presidents.<sup>53</sup>

##### 4.2.1.3.1 *The Balance of the Tribes and Urbanites*

The balance in the leadership Barzani supported saw the position of Secretary-General going to a leftist, and two tribal elders in the positions of vice-presidents. These appointments created problems with the *Shorish* leaders, and Ibrahim Ahmed chose not to be involved with the KDP and instead joined the ICP.<sup>54</sup> The ICP *Azadi* faction grew rapidly as a result.<sup>55</sup> In response, Barzani pursued an overtly nationalist line in appealing for Kurds to support the KDP.<sup>56</sup>

With the collapse of the Mahabad Republic in early 1947, the closure of the KDP-I branches in Iraqi Kurdistan, and the exile of Barzani, parts of the urban leftist

<sup>51</sup> Kutschera (1979) *op. cit.*, p. 190.

<sup>52</sup> Ghareeb (1981) *op. cit.*, p. 35.

<sup>53</sup> Gunter (1996a) "The KDP - PUK Conflict in Northern Iraq." *Middle East Journal* Vol. 50, No. 2 (Spring 1996), pp. 225-241, p. 226.

<sup>54</sup> For an analysis of the Iraqi Communist Party, see Batatu (1978) *The Old Social Classes and the Revolutionary Movements of Iraq: A Study of Iraq's Old Landed and Commercial Classes and of its Communists, Ba'thists, and Free Officers*. NJ: Princeton University Press; Jawad (1981) *Iraq and the Kurdish Question 1958 - 1970*. London: Ithaca Press.

<sup>55</sup> Batatu (1978) *op. cit.*, pp. 628-629; Ghareeb (1981) *op. cit.*, p. 35, quoting Talabani, 1971; Entessar (1992) *op. cit.*, p. 57.

<sup>56</sup> See Andrews (1982) *The Lost Peoples of the Middle East: Documents of the Struggle for Survival and Independence of the Kurds, Assyrians, and Other Minority Races in the Middle East*. Salisbury NC: Documentary Publications, p. 131.

intelligentsia rallied to the banner of the Iraqi KDP, including Ibrahim Ahmed.<sup>57</sup> However, these youthful revolutionaries became opposed to the blandness of the party which had been designed to appease the tribal elements of Iraqi Kurdistan. After a year of drifting, the new leftists convened a second congress in 1951 which elected Ibrahim Ahmed as Secretary-General. Barzani remained Leader-in-exile.<sup>58</sup>

#### 4.2.1.3.2 *The KDP after the Collapse of the Mahabad Republic*

The collapse of the Mahabad Republic in 1946 allowed the urban intelligentsia of the KDP to dominate the direction of the party. After the fall of Mahabad, Barzani's brigade was attacked by the Iranian military.<sup>59</sup> Barzani crossed back into Iraq in April only to face repression from the GOI, with the deprivation of property and land, and, ultimately, the execution of four tribal leaders in May and the condemning to death of Barzani himself.<sup>60</sup> Barzani had little option but to fight his way out of Iraq and seek sanctuary in the USSR. He left Iraqi Kurdistan on 27 May 1947 with 496 followers for Iran.<sup>61</sup> After three weeks of fighting with the Iranian army, the Barzanis crossed into Soviet territory, 300km from Iraq, on 15 June. Barzani was to stay in exile for 11 years until his return to Iraq in 1958, with the KDP being run by Ibrahim Ahmed.<sup>62</sup>

#### 4.2.1.3.3 *The Kurdistan Democratic Party of Ibrahim Ahmed*

The Third Congress of 1953 changed the name of the party to the Kurdistan Democratic Party as a gesture towards nationalism, and adopted a leftist programme calling for agricultural reform and recognition of peasants' and workers' rights.<sup>63</sup> Under the leadership of Ibrahim Ahmed, the KDP worked among students and intellectuals, but received little support from rural areas which remained dominated by tribal leaders.<sup>64</sup> While some tribal discontent was still apparent among the

<sup>57</sup> Farouk-Sluglett & Sluglett (1990) *op. cit.*, pp. 28-29.

<sup>58</sup> Kurdistan Democratic Party (1993a) *Kurdistan Democratic Party (KDP) Congresses 1946-1993*. Erbil: Kurdistan News Press; Amin (1999) *op. cit.*

<sup>59</sup> Farouk-Sluglett & Sluglett (1990) *op. cit.*, pp. 28-29.

<sup>60</sup> O'Ballance (1996) *op. cit.*, p. 34.

<sup>61</sup> Eagleton (1963) *op. cit.*; Ghafour (1997) *op. cit.*, p.10.

<sup>62</sup> Ghareeb (1981) *op. cit.*, p. 34; O'Ballance (1996) *op. cit.*, pp. 33-35; Ghafour (1997) *op. cit.*, pp. 9-10.

<sup>63</sup> Kurdistan Democratic Party (1993a) *op. cit.*

<sup>64</sup> Farouk-Sluglett & Sluglett (1990) *op. cit.*, p. 30. Nawshirwan Mustafa notes that, in this period, the KDP leadership in Iraq produced literature venerating the figure of Barzani, picturing him as an



remaining Barzanis and other tribes, the main source of unrest in Iraq during the 1950s was of a socio-economic nature rather than tribal, allowing the KDP under the leadership of Ibrahim Ahmed to increase its strength.<sup>65</sup> McDowall notes that “. . . . *social change and growing discontent were already under way [by 1953] and the increasingly socialist hue of party doctrine was in tune with the times.*”<sup>66</sup>

Improved economic conditions in Iraq, caused by increased oil wealth, were not trickling down to the lower social echelons of Iraq, and particularly in the Kurdish regions, with the result that many Kurds were migrating to urban areas in search of employment in the oil industry.<sup>67</sup> Throughout the 1950s, the need for agricultural development was urgent, yet the mechanization of the agricultural sector put peasants out of work and gave more wealth to the landlords, thereby exacerbating class divisions in Iraqi Kurdistan. The KDP and the ICP therefore were able to secure an increased support base in the rural areas of the region, and the KDP under Ibrahim Ahmed adopted a closer relationship with the ICP.<sup>68</sup>

#### 4.2.1.3.4 *The Emergence of New Cadres*

In 1956, Hamza Abdullah was re-admitted into the KDP Political Bureau and Central Committee, and many ICP members joined in 1957. For a while, to indicate these additions, the KDP became known as the United-KDP (U-KDP). The U-KDP had a Central Committee of twenty-one members, and an inner Political Bureau of five, which included some who were going to become important actors in the future of the Kurdish struggle, namely Ibrahim Ahmed, Jalal Talabani, Omar Mustafa, Nuri Shawais, and Ali Abdullah.<sup>69</sup> The orientation of the party remained clearly socialist, even though Barzani remained President-in-exile.<sup>70</sup>

#### 4.2.1.4 Conclusion

Changing social conditions in Iraq and Iraqi Kurdistan and leftist expressions of Arab and Kurdish nationalism encouraged the Kurdish tribes to distance themselves from

---

invincible mythical leader. His conclusion is that the KDP leadership was of weak personality and feeble character (Amin (1999) *op. cit.*).

<sup>65</sup> O'Ballance (1973) *op. cit.*, p. 58.

<sup>66</sup> McDowall (1996) *op. cit.*, p. 299.

<sup>67</sup> *Ibid.*

<sup>68</sup> *Ibid.*

<sup>69</sup> O'Ballance (1973) *op. cit.*, p. 61.

the Iraqi monarchy. Similarly, the KDP was also reacting to events in the Middle East. By 1958, the KDP had been in touch with the Free Officers of Iraq, chaired by Brigadier Abdul Karim Kassim, who sought the overthrow of the Iraqi monarchy and establish a democratic state in Iraq.<sup>71</sup>

#### 4.2.2 The Free Officers Coup

The Free Officers overthrew the monarchy and seized power on the 14 July 1958. In an effort to unify the country and to broaden his support base, Kassim needed the support of the Kurds, and followed a pro-Kurdish policy.<sup>72</sup> On 27 July 1958, the Provisional Constitution was announced, and Article 23 stated that: "*The Kurds and the Arabs are partners within this [the Iraqi] nation. The Constitution guarantees their rights within the framework of the Iraqi Republic.*"<sup>73</sup>

Kassim also released numerous Kurds and Barzani himself was pardoned for his previous insurrections and, after several rounds of negotiations between Ibrahim Ahmed and the GOI including an appeal to President Nasser of Egypt, was formally invited to return to Iraq. On 6 October 1958, he returned to Baghdad from exile.<sup>74</sup>

##### 4.2.2.1 The Return of Barzani

Barzani arrived back in Iraq on 6 October to a KDP greatly different to the organization he left behind. Barzani's return was not greeted with enthusiasm beyond his own tribe. Tribal enemies of the Barzanis feared that they would lose the Barzani land granted to them by the GOI after Barzani was exiled, and within the KDP, there was open animosity between Ibrahim Ahmed and Barzani.<sup>75</sup> Barzani in particular was displeased with the overtly socialist orientation the KDP had developed during his years in exile.<sup>76</sup> However, each realised that they needed the other. Ghareeb suggests that;

---

<sup>70</sup> McDowall (1996) *op. cit.*, p. 300.

<sup>71</sup> O'Ballance (1973) *op. cit.*, pp. 61-62; McDowall (1996) *op. cit.*, p. 300.

<sup>72</sup> Zaid (1970) *op. cit.*, p. 7; O'Ballance (1973) *op. cit.*, pp. 62-63; Taubinger (1975) "Suffering and Struggle of the Kurds," *Case Studies on Human Rights and Fundamental Freedoms: A World Survey*, Vol. 1. The Hague: Martinus Nijhoff, p. 250; Ghareeb (1981) *op. cit.*, p. 38.

<sup>73</sup> Ghareeb (1981) *op. cit.*, p. 38.

<sup>74</sup> Gunter (1993a) *op. cit.*, p. 11; Amin (1999) *op. cit.* Amin notes how the Abdel-Karim Kassim was not in favour of the return of Barzani, and instead it was facilitated by Abdussalam Arif, the Deputy Prime Minister.

<sup>75</sup> Interview with Jalal Talabani, Kalarcholan, 5 September 2000.

<sup>76</sup> Ghareeb (1981) *op. cit.*, p. 39.



*“A marriage of convenience, albeit with suspicion on both sides, seems to have been struck between the KDP intellectuals and Barzani. They needed a strong figure who had popular appeal and military strength, and he needed a structure through which to act and receive advice.”<sup>77</sup>*

#### 4.2.2.2 The Impact of the Agricultural Reforms of Kassim

The return of Barzani coincided with further socio-economic upheavals from which he would subsequently benefit. The tribal-urban division within Kurdish society was polarised by the impact of the domestic policies of Kassim. In 1958, Kassim enacted his reform of agricultural lands, which were against the interests of the major land owning tribes.<sup>78</sup> To protect their interests, the tribes recognised the ability of Barzani to effect an alteration in the policies of the GOI, and a secret agreement was reached with Barzani promising to stop or hinder the reforms in return for the support of the tribes. Conversely, the Kurdish Union of Farmers joined the KDP in an attempt to weaken the feudal system of Kurdistan. At this point, the line was drawn between feudals and farmers, and they were fighting for self-interest above anything else. Commentating on this division, Dr Kamal Khoshnaw noted that *“there was a division according to interest . . . . even the Political Bureau of the KDP did not have the power to motivate people politically, it was purely interest driven.”<sup>79</sup>*

Within Iraq as a whole, Kassim was surviving politically by gaining the support of different political groupings and, invariably, turning against them when they grew more powerful under his patronage. Kassim had become extremely concerned about the growth of Communism in Iraq, and the ICP in particular. Barzani therefore drew the KDP away from the ICP, contrary to the wishes of Ibrahim Ahmed, and purged the party of communist members who had joined in the period of cooperation between the two groups. The U-KDP then reverted back to the KDP label.

---

<sup>77</sup> *Ibid.*

<sup>78</sup> See Gabbay (1978) *Communism and Agrarian Reform in Iraq*. London: Croom Helm; Jawad (1979) “The Kurdish Problem in Iraq,” in Kelidar, (ed.), 1979 *The Integration of Modern Iraq*. London: Croom Helm, p. 175; Ockerman & Samano (1985) *op. cit.*; Hussein (1990) “Iraq’s Agricultural Land Use Program,” in A. Salman (ed.), *Agriculture in the Middle East*. New York: Paragon; Hassanpour (1994) “The Kurdish Experience.” *Middle East Report* 189, no. 24 (July - August 1994), pp. 2-7, p. 5.

<sup>79</sup> Interview with Dr Kamal Khoshnaw, Suleimaniyah, 20 June 1998. Dr Kamal was part of the delegation responsible for assisting in the reconciliation between Barzani and the Political Bureau in the mid-1960s.

However, the KDP was to suffer a similar fate as the ICP, as Kassim predictably decided that the KDP and the Barzanis were becoming too powerful a factor in exerting control over the north of the country.<sup>80</sup> As the KDP was holding its Fifth Congress in May 1960, Kassim was meeting with the *Surchi* and *Herki* tribes, enemies of the Barzanis. Inter-tribal fighting characterised the summer of 1959 as Kassim's policy of weakening the Kurds came into effect and saw the Barzanis pitched against the *Lolans* and the *Pishdaris*, among others. However, Barzani's success in defeating his foes forced Kassim to acknowledge his power and, conversely, his unpopularity among the other tribes.<sup>81</sup>

#### 4.2.2.3 The Road to Rebellion

Relations between the GOI and the Kurds from 1960 deteriorated rapidly. Fighting in Iraqi Kurdistan was nearly all tribally-based, with no involvement from the KDP. However, they were implicated with Barzani in the progression of events. Control of the KDP remained with the Political Bureau of Ibrahim Ahmed based in Baghdad, however, both sides were dependent upon each other, and, while the Political Bureau remained critical of Barzani, it continued to support him as leader.

In March 1961, Barzani returned to Barzan from Baghdad. In June, both Barzani and the KDP presented a request to the GOI for the use of the Kurdish language in Kurdish schools, and for a share of the oil revenues of the Mosul and Kirkuk oilfields. The requests were rejected. The KDP again presented the petition, but with no reply.<sup>82</sup>

Descent into rebellion happened almost inadvertently. The first to revolt were the landholders who sought to reverse the agrarian reforms of the 1950s. Simultaneously, as the GOI's grip on the northern governorates began to weaken, Barzani took the opportunity to attack those tribes who had fought against him, and by mid-August 1961 Barzani had a firm grip on the north. The final part of the revolt was the

---

<sup>80</sup> O'Ballance (1973) *op. cit.*, pp. 68-69; Ghareeb (1981) *op. cit.*, p. 39.

<sup>81</sup> O'Ballance (1973) *op. cit.*, p. 71; Taubinger (1975) *op. cit.*, p. 250.

<sup>82</sup> The reasons why the GOI rejected the demands are identical to why they have consistently rejected Kurdish demands previously and afterwards (such as control of resources, the geopolitical problems of creating separate armed forces, and that the Kurds already had a reasonable degree of recognition). For further details, see al-Kanaani (1965) *Limelight on the North of Iraq*. Baghdad: Dar al-Jumhuriya, quoted in Gunter (1993a) *op. cit.*, p. 12.



mobilization of Barzani's forces on the side of other rebelling Kurdish tribes after the airforce of the GOI responded to guerrilla attacks with indiscriminate bombing. McDowall notes that:

*“Kassim had, in effect, brought together two distinct Kurdish tribal groups, the old reactionary chiefs out essentially to protect their landed interests and Barzani whose agenda was a blend of tribalism and nationalism.”*<sup>83</sup>

This unity between the tribes and Barzani explains why he was able to assume such a powerful position within a relatively short period of time.<sup>84</sup> Barzani reacted to the attacks of the GOI by issuing a proclamation to all Kurds on the 11 September 1961 urging them to take up arms against the Iraqi forces. Since this time, the struggle between the Kurds of Iraq and the GOI has been going on until the present day. It was also the time to which some form of control of Iraqi Kurdish territory by the Kurds themselves can be traced.<sup>85</sup>

#### 4.2.3 Conclusion

The tensions which characterised Iraqi Kurdish politics throughout the second half of the twentieth century existed in the fledgling KDP. The KDP had been formed by an uneasy alliance of tribal and urban-leftist elements, with both attempting to take advantage of the other, but with the urban-leftists falling into the alliance with the tribes through the charisma and achievements of Barzani. The arrival of more radical and energetic leftists such as Ibrahim Ahmed again strengthened the left and the scene was set for the future internecine political fights which came to characterise Kurdish politics from then on.

### 4.3 The Development of the System: The Kurdish Revolution, 1961-1975

Kurdish political events in the 1960s took place against a backdrop of a series of rebellions against the GOI, and a series of coups within it. Figure 4.2 illustrates the

<sup>83</sup> McDowall (1996) *op. cit.*, p. 310.

<sup>84</sup> Gunter poses the question as to how Barzani achieved this popularity and concludes that it was through a combination of communist propagandists and Barzani's involvement with the 1943 revolt and the Republic of Mahabad. However, Kurdish revolutionary sentiment has shown to be dominated mainly by economic concerns and this rebellion is no different. Barzani benefited from the impact of agricultural reforms on the landed classes. (Gunter (1993a) *op. cit.*, p. 13).

<sup>85</sup> Taubinger (1975) *op. cit.*, p. 250; interviews with Sami Abdul Rahman, Salahadin, 3 April 1998; Franso Hariri, Erbil, 23 April 1998.

interrelationships between the tribal and urban Kurds, and the GOI.<sup>86</sup> The Kassim regime was replaced by the Ba'ath Party on 8 February 1963, which was in turn overthrown on 18 November 1963 by the army under Abdul Salam Aref. When President Aref was killed in a plane crash on 14 April 1966, his brother, Abdul Rahman Aref, assumed power. The Ba'ath Party again resumed power on 17 July 1968 under the Presidency of Ahmed Hassan Al-Bakr, and his Vice-President Saddam Hussein.<sup>87</sup> Alongside this unstable situation, the Kurdish political arena was characterised by in-fighting with the left-wing of the KDP becoming increasingly exasperated with Barzani.

A theme for this section is one of a massively unstable political situation in which the leftist-tribal split amongst the Kurds polarises Kurdish politics into the alignments which would characterise the political system in the 1990s. In this section, the progression of the Kurdish Revolution is noted and referenced, with the main focus of this section to bring out the polarisation which occurs in Kurdish politics, and the manner in which the GOI uses, or is used by, Kurdish political characters.

#### 4.3.1 The September 1961 Revolution

The Kurdish revolt began in earnest by March of 1961. The first stage of Barzani's strategy was to consolidate his hold on the mountainous areas of Iraqi Kurdistan by fighting his old enemies, the *Lolani* and *Zebari* tribes.<sup>88</sup> The revolt escalated when Barzani's allies, the *Arkou*, attacked a military column. Kassim's response of the indiscriminate aerial bombing of rural areas, including Barzan villages, resulted in the Barzanis and other tribes rebelling. By the end of September Barzani controlled a swathe of land stretching from Zakho to Suleimaniyah.<sup>89</sup> It is likely that Barzani's motives for fighting were more tribal than national at first. Apart from a few isolated cases over which Barzani had little or no control, neither the Barzanis nor their allies made concerted attacks against the Iraqi army.<sup>90</sup>

<sup>86</sup> Sources for figure 4.2: O'Ballance (1973) *op. cit.*, pp. 74-163; Taubinger (1975) *op. cit.*, pp. 251-258; Vanly (1980) *op. cit.*, pp. 151-177; McDowall (1996) *op. cit.*, pp. 323-339; O'Ballance (1996) *op. cit.*, pp. 81-99; Ghafour (1997) *op. cit.*, pp. 18-41. Key as for Figure 4.1.

<sup>87</sup> Taubinger (1975) *op. cit.*, pp. 251-254.

<sup>88</sup> McDowall (1996) *op. cit.*, pp. 309-310; O'Ballance (1996) *op. cit.*, p. 47.

<sup>89</sup> *Ibid.*

<sup>90</sup> O'Ballance (1973) *op. cit.*, p. 75.



Page  
Numbering  
as  
Bound

#### 4.3.1.1 Kassim's Offensive

Kassim's forces encountered little difficulty in retaking the urban areas and connecting roads. However, Barzani retained the mountainous areas. Kassim therefore targeted the rural infrastructure by bombing the mountain villages, resulting in the destruction of almost 300 villages before the end of the year.<sup>91</sup>

Prior to the commencement of the revolution, the KDP had chosen to remain removed from the fighting, considering any sort of clash with the Iraqi army to be unfavourable.<sup>92</sup> However, on 24 September, Kassim declared the KDP to be illegal, thereby forcing the party to join the rebellion.<sup>93</sup> Within the KDP there had been great discussions concerning the role of the party in the rebellion. Talabani believed that the KDP should attempt to take over the leadership of the rebellion and use it for nationalist purposes, whereas Ahmed believed that the rebellion was totally contrary to the aims and ideals of the KDP. Furthermore, Ahmed still had the experience of Mahabad on his mind and believed that the KDP might disintegrate under the strain of war, particularly as neither the mountain tribesman nor outside support could be guaranteed. However, Talabani wanted to take advantage of the fact that the Iraqi army was a third Kurdish, whom he believed would support the KDP. Talabani travelled to see Barzani, who requested the KDP to wait unless Kassim attacked. The KDP Central Committee convened in December 1961 after several months of separation at Chami Rezan and decided to mount a reorganization of the revolt, and set about re-establishing relations with Barzani.<sup>94</sup>

##### 4.3.1.1.1 *The Formation of the Peshmerga*

Even though the KDP allied itself with Barzani, it was forbidden by him to operate in his spheres of influence and instead operated between Raniya and Suleimaniyah.

---

<sup>91</sup> *Ibid.*, p. 48.

<sup>92</sup> Amin (1999) *op. cit.* Nawshirwan Mustafa notes a Kurdish saying from the time as being 'Barzani and the politburo were in two very distant valleys,' (i.e. they acted separately and one did not know what the other was doing). The politburo eventually sent Talabani to the north from Baghdad to assess the situation, and he decided that it was the right time to mount a revolt.

<sup>93</sup> McDowall (1996) *op. cit.*, p. 310. The KDP political bureau were scattered in an utter state of confusion after the first attack of the Iraqi army: Ibrahim Ahmed and Nuri Shawais remained in Baghdad; Talabani was in Chami Rezan; and Ali Askari and Ahmed Abdulla were in the Bahdinan region (Amin (1999) *op. cit.*).

<sup>94</sup> Amin (1999) *op. cit.* Nawshirwan notes that the cadre responsible for this task was Ali Abdulla, later to become Secretary-General of the KDP in the 1990s under the Presidency of Massoud Barzani, was derided by Barzani for hiding instead of fighting on his return from meeting with the Barzanis.



This division of territory was a reflection of the territorial division between the support bases of Barzani on the one hand and the Political Bureau of the KDP on the other.<sup>95</sup>

Ever wary of forming dependencies on the tribal militia of Barzani, the KDP Central Committee promoted the establishment of a regular-style armed force, which included the solidification of the branch structure of the party, and clandestinely revived urban party organizations, including a covert one within the police forces of Erbil and Suleimaniyah.<sup>96</sup> Barzani was reluctant to form such a unit, and so the KDP established a standing force in their sector which became known as the *peshmerga*. As more officers deserted from the ranks of the Iraqi army, the *peshmerga* numbers swelled, numbering approximately 15,000 men by September 1962.<sup>97</sup> As to be expected from the influx of army personnel, the structural organization of the *peshmerga* commenced with small platoons (*dasteh*) numbering approximately 10 *peshmerga*, to companies (*pel*) of 30 *peshmerga*, and to battalions (*sar pel*) of 120.<sup>98</sup>

Within its region, the KDP organised four regional headquarters. Ibrahim Ahmed commanded Malouma near the border with Iran. Talabani commanded the *Rizgari* Force from the Chamirezan Headquarters to the north of Suleimaniyah; Omer Mustafa commanded the *Kawa* Force from Betwata; Ali Askari commanded the *Khabat* Force from Chwarta; and the Third and Fourth Forces of Qaradagh were commanded by Kamal Mufti, a renegade Iraqi-Kurdish army officer.<sup>99</sup>

It is important to note the impact of the formation of the *peshmerga* on the structure of the KDP and, subsequently, PUK. Due to the location of the KDP in the mountains of Raniya, the initial intake of the new force was predominantly tribal, with Kurdish deserters from the Iraqi army giving it some semblance of regular military organization. To this group was gradually added a mix of urbanised Kurds which provided the germ of Kurdish nationalism promoted by the urbanite KDP. The *peshmerga* had many problems at first, particularly as the tribal Kurds were reluctant

---

<sup>95</sup> O'Ballance (1973) *op. cit.*, p. 79.

<sup>96</sup> Amin (1999) *op. cit.*

<sup>97</sup> O'Ballance (1973) *op. cit.*, p. 85.

<sup>98</sup> Figures from Amin (1999) *op. cit.*

<sup>99</sup> Amin (1999) *op. cit.*; interview with Kamal Mufti, Suleimaniyah, 9 June 1998.

to accept military discipline. However, the army discipline managed to develop them into a rough mountain army, with the *peshmerga* of the KDP being more politically and ideologically motivated than Barzani's undisciplined tribal militia.<sup>100</sup> Such organizational divisions were also reflected in the leadership, with two separate leaderships developing in the field representing the two different wings of the movement. Barzani controlled the Bahdinan, Choman, Rowanduz and Shaqlawa regions, and the Political Bureau controlled Suleimaniyah, Kirkuk and Erbil.<sup>101</sup>

#### 4.3.1.1.2 *The Fall of Kassim*

By 1962 the war was going the way of the rebels, and Kassim was becoming politically isolated. The KDP had identified the Free Officers movement and the Arab Socialist Ba'ath Party (Ba'ath) as being the best placed to stage a coup against Kassim and assured the Ba'ath Party that they would not exploit the weak Iraqi army in the north while the coup was underway. In return it received assurances regarding autonomy.<sup>102</sup> The coup against Kassim occurred on 8 February 1963 and was undertaken by a group of Free Officers, with Ba'ath Party involvement. The victorious junta, named the National Council of the Revolutionary Command (NCRC), appointed Colonel Abdul Salam Aref as President and Ahmed Hassan Al-Bakr as Prime Minister.

### 4.3.2 The Kurds Divided

The Kurds kept to their word and hostilities ceased after the *coup d'etat*. However, Barzani was unwilling to give unreserved support until Kurdish demands were met, which included a ceasefire, the release of prisoners of war, compensation for the injured, the removal of those responsible for torturing Kurds, and an official declaration of autonomy with Kurdish participation in the new central GOI. Barzani also demanded that a KRG should be established which was to have power over domestic affairs.<sup>103</sup>

The attitude of the Ba'athist regime became increasingly antagonistic to the Kurds. Negotiations were further complicated by the potential union of Iraq and Syria,

<sup>100</sup> O'Ballance (1973) *op. cit.*, pp. 85-86.

<sup>101</sup> Amin (1999) *op. cit.*

<sup>102</sup> McDowall (1996) *op. cit.*, pp. 312-313; O'Ballance (1973) *op. cit.*, pp. 95-96.



which would have resulted in the Kurds becoming a minority of 2 million in 13 million, in an Arab dominated state. Similarly, the push towards Arab Nationalism by the Egyptian President Nasser did not leave much opportunity for Kurdish nationalism in territory considered by Arab nationalists as Arab land.<sup>104</sup>

In subsequent meetings between Barzani and the GOI, Barzani increased his demands for an autonomous province to include the governorates of Erbil, Suleimaniyah, and Kirkuk, and parts of Mosul and Diyala governorates; that  $\frac{1}{3}$  of oil revenues to be devoted to the Kurds; that the Vice-President of Iraq be Kurdish; that  $\frac{1}{3}$  of all seats in the GOI go to Kurds and that the Deputy Chief of Staff be Kurdish.<sup>105</sup> He further threatened to re-open Kurdish attacks if the GOI did not agree within three days.

#### 4.3.2.1 Recommencement of Fighting

President Aref concluded that there was no alternative but to fight. The NCRC announced that it was beginning military operations against the Kurds on 10 June 1963. The Kurdish delegation negotiating with the NCRC was arrested as were Kurds in Baghdad and, simultaneously, Iraqi forces opened a major offensive against the *peshmerga*.<sup>106</sup> While the Iraqi army succeeded in capturing the urban areas, the Kurdish forces provided stiff resistance in their mountain strongholds and, with the ousting of the Ba'ath-dominated government by Abdul Salam Aref in November 1963, the army's push against the Kurds collapsed.<sup>107</sup>

The relationship between Barzani and A S Aref appeared to be strong, to the point that there was some communication between the two of them before the coup. This was reflected by Barzani's acceptance of a cease-fire with the GOI on 10 February 1964 without prior consultation with the KDP, creating serious friction between himself and the Political Bureau. The situation was made worse when the new

---

<sup>103</sup> Taubinger (1975) *op. cit.*, p. 251; McDowall (1996) *op. cit.*, p. 313.

<sup>104</sup> Taubinger (1975) *op. cit.*, p. 251; O'Ballance (1973) *op. cit.*, pp. 100-101. Talabani, in negotiations with Nasser at this time, was assured of his sympathy for the Kurds, but not for their autonomy.

<sup>105</sup> O'Ballance (1973) *op. cit.*, p. 101. McDowall provides a slightly different account, with the demands including a separate Kurdish armed forces, and that Kurdistan should receive  $\frac{2}{3}$  of the national oil revenue (McDowall (1996) *op. cit.*, p. 314).

<sup>106</sup> Taubinger (1975) *op. cit.*, p. 251.

<sup>107</sup> Ghareeb (1981) *op. cit.*, p. 67.

Provisional Constitution offered far less to the Kurds than previous agreements. Barzani had put his name to an agreement which omitted any mention of self-administration, let alone Kurdish autonomy, infuriating the Political Bureau.<sup>108</sup>

#### 4.3.2.2 The KDP Divided and the Aggregation of Left-Wing Groupings

The actions of Barzani created serious tensions in the ranks of the KDP. Whether Barzani did this to create a division and thereby have reason to attack the left wing of the KDP is unknown. However, his acceptance of an alliance with the new regime, the issuing of a warning stating that resistance to government forces would constitute a declaration of war against the Barzanis, and his indicating to the GOI that he had no objection to the abolition of political parties, certainly suggests that this was a plan to split the left-wing off the KDP.<sup>109</sup>

Kurdistan was totally divided. The KDP Political Bureau, which included Ibrahim Ahmed, Jalal Talabani, and Omer Mustafa vehemently opposed Barzani's actions which they described as being autocratic.<sup>110</sup> The Political Bureau travelled to Raniya to meet with Barzani and debate the agreement reached with the GOI. They argued that the agreement gave much less than Kurdish aspirations, whereas Barzani argued that the Kurdish people were tired and would be able to force autonomy at a later point. The Political Bureau attempted to create a negotiating body between Barzani and the KDP to present Kurdish demands to the GOI, but was blocked by Barzani, who instead demanded the resignation of Ibrahim Ahmed as Secretary-General.

The response of the Political Bureau was to hold a conference in Mawat on 4-9 April 1964. Attended by approximately 70 members, the conference resulted in the Political Bureau stripping Barzani of his authority to negotiate with the GOI. In response, Barzani expelled key *peshmerga* commanders including Omer Mustafa, Ali Askari, Kamal Mufti and Talabani. In the mind of Talabani, the KDP ceased to exist after 1964 due to the expulsion of its most capable members.<sup>111</sup>

<sup>108</sup> *Ibid*, p. 40; McDowall (1996) *op. cit.*, p. 315.

<sup>109</sup> McDowall (1996) *op. cit.*, pp. 315-316.

<sup>110</sup> Interviews with Kamal Mufti, Suleimaniyah, 9 June 1998; Kamal Khoshnaw, Suleimaniyah, 20 June 1998.

<sup>111</sup> Interview with Jalal Talabani, Kalarcholan, 5 September 2000.



However, Barzani's influence proved to be strong, particularly as he was famed for reviewing his forces in the field compared to Ibrahim Ahmed who rarely undertook reviews. The result was the KDP rank-and-file carrying out Barzani's decisions, with the Political Bureau being ignored.<sup>112</sup> To legalise his own decisions within the KDP, Barzani convened his own Sixth Congress in Baghdad where fourteen of the former members of the leadership were charged with treason and expelled, allowing him to form a new leadership.<sup>113</sup> Many commentators identify the events of 1964 as heralding the origin of the PUK. Nawshirwan Mustafa contends that;

*"In the history of the political movement of Iraqi Kurdistan, 1964 constitutes an ominous turning point, whose ramifications are deep-rooted in the Kurdish movement. The conflict between the leader of the party and the secretary-general penetrated into the core of the political and military organizations of the party and subsequently into all the people and the Kurdish movement and formed the inception and starting point of a permanent civil war."*<sup>114</sup>

However, this split should not be seen as the first alignment of what was to become the PUK. Important members of the contemporary PUK, such as Dr Fu'ad Massoum and Adil Morad, apart from Talabani, remained allied with Barzani in 1964. Similarly, characters who would later become staunch Maoists and core members of the PUK displayed considerable unity with Barzani against the Talabani-Ahmed line.

#### 4.3.2.3 An Analysis of the Division

Within the Political Bureau, three separate groups developed attempting to identify the best strategy of handling the division. The first group, which included Nawshirwan Mustafa, urged the Political Bureau to support the actions of Barzani; the second group, which included Shahab Shiekh Nuri, wanted the Political Bureau to fully support the Ahmed-Talabani line and split with Barzani, and; the third group, which included Abdel Sittar and Mulla Abdulla Mutto, espoused an additional strategy of supporting the GOI. Many members who would later become radical

<sup>112</sup> Amin (1999) *op. cit.*

<sup>113</sup> Those expelled included: Ibrahim Ahmed, Nuri Shawaise, Ali Abdulla, Omer Mustafa, Jalal Talabani, Hilmi Ali Sharif, Mulla Abdulla, and Sa'id Aziz Shamzini. The new leadership was formed from: Habeeb Karim, Dr. Mahmoud Othman, Salih Yousufi, Isma'il Arif, Abduli Soran, Siddiq Amin, Omer Sharif, Sheikh Muhammad of Harseen, Aziz Aqrawi, Dr. Fu'ad Jalal, Ali Sinjari and Yadulla Faili (Amin (1999) *op. cit.*).

<sup>114</sup> *Ibid.*

members of left-wing parties, such as Nawshirwan Mustafa, chose to stay with Barzani due to an understanding of *realpolitik* rather than any liking for him.<sup>115</sup>

One of the intermediaries between the Political Bureau and Barzani, Dr Kamal Khoshnaw, noted the futility of opposing Barzani and the GOI. They felt that in order to have any hope of surviving as a political unit, they had to exist in the mountains with Barzani and attempt to promote their left-wing ideals from within the party, rather than being part of a smaller faction with support only in urban areas which were occupied by the Iraqi army.<sup>116</sup> Such astute political thinking characterised the actions of Nawshirwan Mustafa in particular.

However, the Ahmed-Talabani faction remained opposed to Barzani. After they tried to rally support against Barzani, he expelled them from the KDP Central Committee and drove them and their 4,000 followers into Iran in July 1964. Barzani then demanded autonomy from Aref, using the very arguments of Ahmed and Talabani, and increasing his demands to include the oilfields of Kirkuk in October, forcing the GOI to launch an offensive against Kurdistan in March 1965.

The death of the Iraqi President Abdul Salam Aref in a helicopter crash in 1965 resulted in a ceasefire, but fighting was resumed with the assumption to power of Abdul Rahman Aref in 1966. The attempts of Prime Minister Bazzaz to secure peace appeared at first to be successful with a 15-point offer, the Bazzaz Declaration, fulfilling most of the Kurdish demands. However, army officers forced Aref to put pressure on Bazzaz, resulting in his resignation. His successor, Naji Taleb, an army officer, did not have any intention of implementing the Bazzaz Declaration.<sup>117</sup>

The disagreements between Barzani and the Ahmed-Talabani faction had not been forgotten, and had now developed into a bitter feud. The faction again broke with Barzani in January of 1966 and commenced hostilities against him, this time funded by the GOI and in cooperation with the *jash*, the Kurdish tribes fighting on the side of the government.

---

<sup>115</sup> Interview with Kamal Khoshnaw, Suleimaniyah, 20 June 1998.

<sup>116</sup> *Ibid.*

<sup>117</sup> McDowall (1996) *op. cit.*, pp. 317-320.



During this period, a ceasefire was in effect. Barzani used it to again consolidate his hold in Kurdistan, and increased his demands to the GOI, and it was at this time that the infamous link to Israel and also to Iran was developed. The link to these ideological enemies of the Iraqi regime proved to be devastating for the GOI. Faced with Kurdish *peshmerga* benefiting from Israeli assistance, and the capacity given by Iran to the *peshmerga* that they could evacuate to safe areas at times of attack by the Iraqi forces, resulted in the Iraqi military unable to deal with the Kurds. The weakness of the regime allowed the Second Ba'athist Coup to take place in 1968 under the leadership of Hassan Al-Bakr.

### 4.3.3 The Kurds Under the Ba'ath

The Ba'ath Party staged a *coup d'etat* against the regime of Abdul Rahman Aref on 17 July 1968, with Ahmed Hassan Al-Bakr becoming President. The party also declared that it intended to respect the aspirations of the Kurdish people and the declaration of the Bazzaz programme. However, this was probably more of an expression of the party's opposition to the previous regime rather than attempting to reach a peaceful solution to the Kurdish issue.<sup>118</sup>

#### 4.3.3.1 Internecine Fighting

Barzani was not supportive of this new Ba'ath position. Both sides were greatly suspicious of each other, particularly as Barzani had assisted Aref in bringing the Ba'ath regime down in 1963, and the Ba'ath offensive of 1963 had been one of the fiercest assaults against the Kurds.<sup>119</sup> However, the position of the Ahmed-Talabani faction, which was now in opposition to Barzani, was one of reconciliation with the new regime. The two groups fought sporadically in Iraqi Kurdistan in the autumn of 1968. The Ba'ath preferred to deal with the Ahmed-Talabani faction as they were seen to be ideologically similar.

However, Barzani retained military supremacy in Kurdistan. He attacked oil installations in Kirkuk at the beginning of 1969, and was having little trouble in

---

<sup>118</sup> Ghareeb (1981) *op. cit.*, p. 73.

<sup>119</sup> *Ibid*, pp. 74-75.

keeping the forces of the Ahmed-Talabani faction in check.<sup>120</sup> Fighting escalated throughout the summer, with the GOI backing the Ahmed-Talabani faction, and Iran supplying Barzani. Interestingly, the ICP also backed Barzani due to its hostile attitude towards the Ba'ath. However, the Ba'ath proceeded to consolidate its position and won over some Kurdish sentiment by granting lesser requests such as the establishment of the Kurdish new year (*Nawruz*) as a national holiday, the teaching of Kurdish in all Iraqi schools, the establishment of the University of Suleimaniyah, and the formation of Dohuk Governorate.

#### 4.3.3.2 Ba'ath – Barzani Rapprochement

The success of Barzani against the Ahmed-Talabani faction forced the GOI to negotiate with Barzani. The potential for outmanoeuvring the Ahmed-Talabani faction led Barzani into negotiations with the GOI in December 1969. The talks between the two parties stalled on the status of Kirkuk, with Barzani wanting it to be included in any autonomous Kurdish region. The Ba'ath insisted that the demarcation of the autonomous region would depend on where there was a proven majority, and that this would be decided either by plebiscite or census.<sup>121</sup>

The Ba'ath, ever concerned about the stability of their regime and the destructive effect the Kurds had had on their last period in power, were eager to obtain some form of agreement with the Barzani. The Vice-President of Iraq, Saddam Hussein, travelled to Kurdistan to meet with Barzani, who was presented with blank sheets of paper and told to write his demands. Saddam took back to Baghdad details that led to the March Agreement.

#### 4.3.4 The March Agreement and the *Ashbatal*

The March Agreement was the best deal ever offered to the Iraqi Kurds. At the time of signing, the Agreement was hailed as a sincere move towards solving the Kurdish problem by all parties. Although Barzani still did not trust the Ba'ath, Kurdish opinion was strong enough for him to sign the agreement. For the Ba'ath regime, the

---

<sup>120</sup> *Ibid*, p. 77.

<sup>121</sup> McDowall (1996) *op. cit.*, pp. 326-327.



agreement was born out of grim geopolitical necessity as, apart from the Kurds, the Ba'ath had no actual or potential political allies within Iraq.<sup>122</sup>

The GOI kept to its word in the implementation of the Agreement. A commission comprised of four Kurds and four Arabs was established, President al-Bakr reshuffled his cabinet appointing five Kurds in the process, and Barzani-KDP members were appointed as Governors of Suleimaniyah, Erbil and Dohuk. By the end of April, the Kurdish language was starting to be used in Kurdistan, Kurdish journals appeared and public organizations established.<sup>123</sup>

#### 4.3.4.1 The Golden Period

One of the Kurdish negotiators of the March Agreement, Sami Abdul Rahman, described it as being the start of a “*golden period*”. The period 1970-1974 saw *de facto* autonomy throughout the region with the KDP effectively controlling the region through the appointment of the governors. During this period, the Kurds learned the techniques of administration and governance. Sami was appointed the Minister of Northern Affairs, and, with reference to the period, noted that;

“[During 1970-1974 the Kurds gained] *four years [experience] of direct governance and administration in Erbil, Dohuk and Suleimaniyah governorates . . . . Kurds were also represented by five cabinet ministers in Baghdad. During this period, the KDP had a strong military force, and Kurdistan was peaceful.*”<sup>124</sup>

However, the trust between the KDP and the Ba'ath Party did not last for long. At the end of 1970 an attempt was made upon the life of Barzani's eldest son, Idris, in Baghdad, and arguments raged throughout 1971 concerning the demographic alteration of Kurdish areas by government Arabization policies.<sup>125</sup> Conversely, the Ba'ath suspected the Kurds of packing Kirkuk with Kurds from Iran and Turkey. Relations between the Ba'ath and Barzani deteriorated to the point when Barzani advocated taking up arms over the status of Kirkuk, and the GOI attempted to assassinate Barzani himself in September 1971.

<sup>122</sup> See The Times, 4 July 1970; McDowall (1996) *op. cit.*, p. 328.

<sup>123</sup> *Ibid*, p. 329.

<sup>124</sup> Interview with Sami Abdul Rahman, Salahadin, 3 April 1998.

<sup>125</sup> McDowall (1996) *op. cit.*, p. 329.

#### 4.3.4.2 The Involvement of External Powers

Barzani raised the stakes and demanded additional items to be included in the March Agreement, including the withdrawal of the Iraqi army from Kurdistan, and the inclusion of Kurds into the power-holding Revolutionary Command Council. 1972 saw Barzani behave increasingly antagonistically towards the government, particularly by not sealing the border with Iran, as required by the March Agreement, and appealing to the US for aid. The nationalisation of the oil industry by the GOI in 1972 drew the US closer to Barzani, as it did not like losing control of Iraqi oil.<sup>126</sup>

However, the KDP misjudged the situation. US policy towards the Kurds was one of keeping a delicate *status quo* in effect in order to secure its own vital interests, a policy which has arguably persisted to the present day. Having supported Israel during the 1967 Arab-Israeli War by occupying units of the Iraqi army in Kurdistan, Barzani also received Israeli support in return. The GOI was therefore massively concerned about the involvement of the Kurds with three rivals of the regime, namely the US, Iran and Israel. Both sides verbally attacked the other for not keeping to the terms of the agreement and the strength of the attacks brought about the collapse of the agreement. Both sides were guilty of failings which caused irreparable damage to the intrinsically fragile working relationship. McDowall contends that:

*“While Baghdad had to accept that its reluctance to implement the spirit of the accord left Mulla Mustafa with the irresistible temptation of resuming foreign friendships, the Kurds had to recognize that their outright association with ‘imperialist’ enemies had cost them dear inside Iraq.”<sup>127</sup>*

In 1974, the Ba’ath regime went ahead with a development of the autonomy law, and chose to negotiate with 600 independent and anti-Barzani Kurds, including the Ahmed-Talabani faction.<sup>128</sup> The GOI also sought to create rifts in Kurdish society by claiming that the KDP no longer fought for the interests of the Kurdish nation. Barzani, increasingly dependent upon Iranian supplies and assistance, was similarly preparing for a confrontation.

<sup>126</sup> *Ibid*, p. 331, quoting Ghareeb (1981) *op. cit.*, p. 141.

<sup>127</sup> *Ibid*, p. 332.

<sup>128</sup> *Ibid*, p. 333.



#### 4.3.4.3 The 1974 Autonomy Law

Negotiations between the two groups continuously floundered over the status of Kirkuk, with Barzani insisting upon its inclusion in a Kurdish autonomous entity as capital of the region, and the GOI pursuing a policy of removing Kurds from the city and introducing Arab settlers.<sup>129</sup> However, the GOI was willing to allow the Kurds to have Chamchamal and Kalar, and allow for some form of Kurdish representation in Kirkuk. Neither side was willing to budge, even though Erbil and Suleimaniyah were the two most important cities in terms of Kurdish culture, and arguably more suitable as a capital.

The GOI published its Autonomy Law on 11 March 1974. Barzani was given a fortnight to accept its proposals and join the coalition of parties known as the National Front. The Autonomy Law offered the Kurds far more than they had ever previously received, but it still fell short of the 1970 Agreement, and Barzani's demands regarding Kirkuk. The law effectively took away the power enjoyed by the governors and handed it to the central ministries in Baghdad. The President of the Republic had ultimate powers over the Executive Council of the Autonomous Region, and all decisions were subject to the Supreme Courts in Baghdad. In discussing these laws, McDowall notes that "*It is clear that these articles allowed Baghdad to retain powers which, by judicious exercise, could effectively strip the autonomous region of any real self-control.*"<sup>130</sup> Such opinions are supported by those Kurds who were part of the administrative system at the time. Sami Abdul Rahman stated that "*In 1974 the Ba'ath offered autonomy of a diminished nature. In practice it was called Paper Autonomy, and secretariats existed which answered directly to Baghdad.*"<sup>131</sup> Barzani and the KDP formally rejected the Autonomy Law, prompting yet another split within the Central Committee of the KDP, with prominent members, including Barzani's eldest son Ubayd Allah Barzani, feeling compromised by Barzani's alliances with three of Iraq's enemies.

By April, the sides were drawn for battle. However, because of the relationship with external powers, and particularly Iran, Barzani had prepared to fight in a

---

<sup>129</sup> *Ibid*, p. 335.

<sup>130</sup> *Ibid*, p. 336.

<sup>131</sup> Interview with Sami Abdul Rahman, Salahadin, 3 April 1998.

conventional manner, which proved to be disastrous. The Iraqi army succeeded in capturing Amadia, Aqra, Raniya, Rowanduz and Qala Diza by mid-1974. The Iranians were forced to provide large amounts of overt support to Barzani, including the deploying of regular forces and artillery. However, the Kurdish forces remained far inferior to the Iraqi army.

#### 4.3.4.4 The Military Organization of the KDP

During this time, the KDP can be viewed as divided between party and *peshmerga* affairs more so than in previous times. The *peshmerga* was still the dominant element of the party, with Zaid putting their numbers at 180,000–200,000 mobilised personnel, with 40,000 reserves.<sup>132</sup> They were divided into 3 divisions (presumably by governorate), and 17 brigades of varying size.<sup>133</sup> The leadership of the revolution was exercised through a structure known as the Command Council headed by Barzani and comprising 46 members who elected an Executive Bureau of 9 members. The KDP was represented on each of these by members of the Political Bureau and Central Committee. Figure 4.3 illustrates this organizational structure and the dominance of the Barzanis over both the political and military wings.

It would therefore seem that the division between the tribes and the intelligentsia would still be identifiable, with positions on the Executive and Command Councils being open to those tribal *peshmerga* commanders not actually in the KDP. The role of the Political Bureau was the political training of party cadres, the provision of primary education in liberated areas, and the collection of taxes and management of the judiciary.<sup>134</sup> It is interesting to note that the Kurdish leadership had also formed a number of administrative organs in place of the executive bodies of the GOI. Such offices included finance, agriculture, interior, employment, health, justice and education.<sup>135</sup>

---

<sup>132</sup> Zaid (1970) *op. cit.*, p. 10.

<sup>133</sup> *Ibid.*

<sup>134</sup> *Ibid.*

<sup>135</sup> It is possible to identify some of the previous holders of these positions in the mountains now holding similar positions within the KRG. For example, Hackam Khadr (Khadr Hama Jan) of the PUK was once a military judge in the *peshmerga* (Hackam means judge). He was then made head of Erbil Asayash (secret police) and then Governor of Suleimaniyah.



**Figure 4.3: Organizational Structure of KDP During the 1975 Revolution**<sup>136</sup>

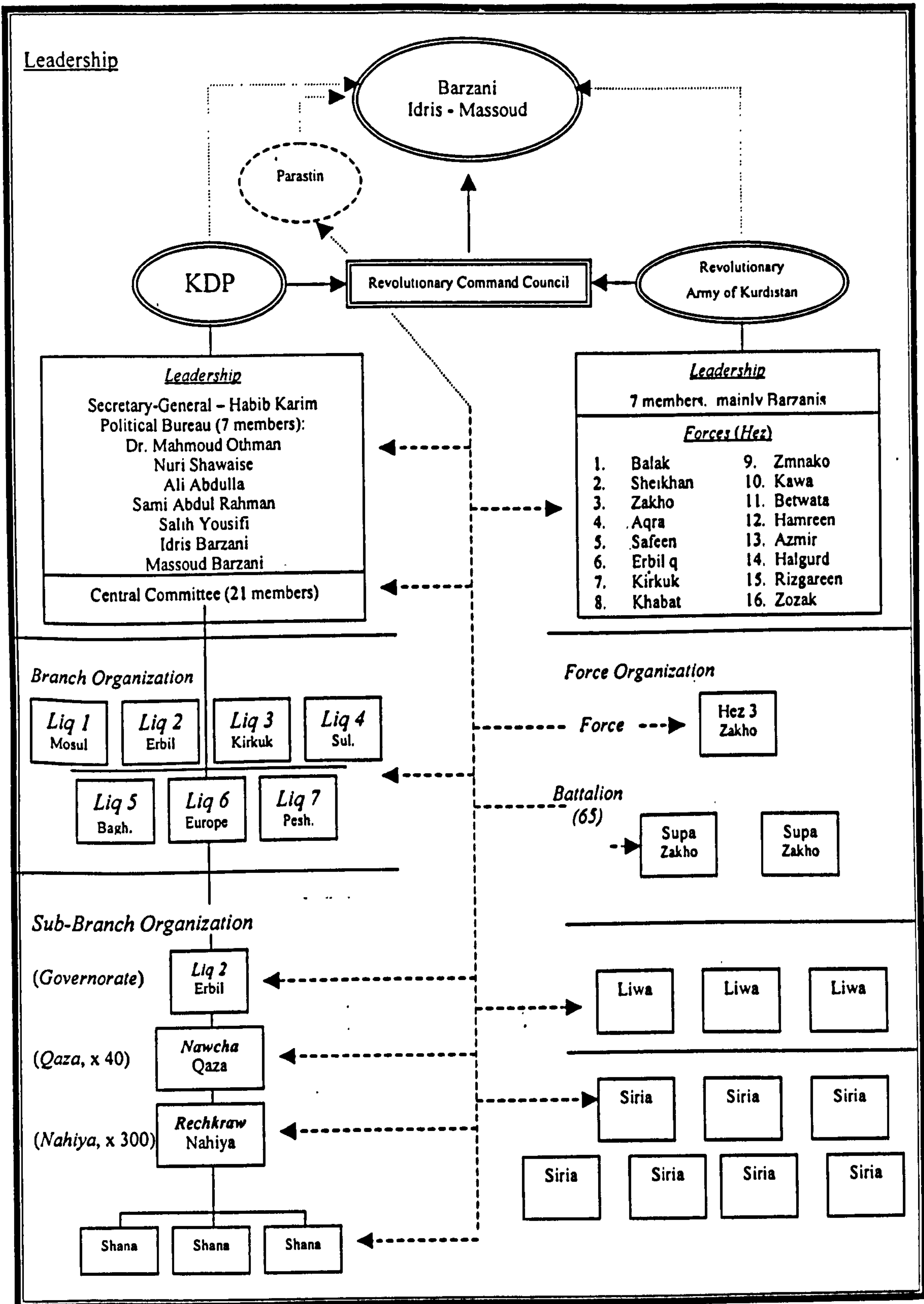

<sup>136</sup> Zaid (1970) *op. cit.*; Amin (1999) *op. cit.*

The *Parastin* became notorious as the secret information service ostensibly of the KDP but in reality of the Barzanis. Its tasks included collecting news and sundry information, facilitating assassinations and covert operations and sabotage. The number of *Parastin* personnel is impossible to ascertain, as is detail regarding the internal structure. However, as so much of the Iraqi Kurdish political structure seems to be based on a cellular-type arrangement, it is likely that the *Parastin* was so organized. The head of the organization in the mid-1970s was Massoud Barzani. In the 1990s, the head of this organization would become Nechervan Barzani, the son of Idris, and then after the Twelfth Congress of the KDP in 1999, Massoud's son Masrour appears to be increasingly prominent. However, the position of Massoud within the *Parastin* (which would later be renamed *Rechrastini Taybet*) remains unparalleled and he has kept a predominant position within the organization.

#### 4.3.4.5 The Algiers Agreement and the Ashbatal

The only possibility the Kurdish forces had against the GOI military was of a full-scale intervention on their behalf by Iran. However, it was not a particularly attractive option for the Iranians, particularly as the GOI had been in negotiations with them for months resulting in the Iraqis offering to cede the Shatt al-Arab waterway in return for Iran withdrawing its support for the insurgent Kurds. On 6 March 1975, at the Organization of Petroleum Exporting Countries (OPEC) Conference in Algiers, Saddam and the Shah of Iran formally settled all outstanding border differences, with both parties agreeing to maintain border security and prevent subversive infiltration, effectively destroying the lifeline of the *peshmerga*.<sup>137</sup> The Kurdish forces were devastated by this agreement. Barzani, Muhsin Dizayee and Mahmoud Othman met with the Shah on 12 March and were told that all support was finished.<sup>138</sup> Barzani's decision to end the Kurdish revolution was, perhaps, one of his most contentious. Jalal Talabani, for example, still claims that the decision was made due to Barzani's tribal interests;

---

<sup>137</sup> Jalal Talabani claims that he was notified in Cairo by the Soviet KGB officer Yevgeni Primakov (later Prime Minister of Russia) of the Algiers Agreement in early 1975, but the Barzani leadership refused to believe him. Patriotic Union of Kurdistan (1977) *Revolution in Kurdistan: The Essential Documents of the Patriotic Union of Kurdistan*. New York: PUK Publications, p. 1; McDowall (1996) *op. cit.*, p. 338; interview with Jalal Talabani, Kalarcholan, 5 September 2000.

<sup>138</sup> Interview with Feyeraadun Abdelkadir, Suleimaniyah, 10 August 1999.



*“The feudal leadership (the Barzanis) surrendered because of the lack of support from the West. They (the Barzanis) still had thousands of people under arms, at least US\$ 150 million, and stores of weapons and ammunition. He finished the revolution because of his position of leader of the tribe . . . . he wanted the money.”<sup>139</sup>*

The decision to abandon fighting was taken on 23 March 1975, and thousands of Kurdish families sought refuge in Iran or surrendered to the Iraqi army.<sup>140</sup> With the collapse of the Kurdish Revolution, the Ba’ath was free to implement the Autonomy Law.<sup>141</sup> The KDP was no longer a political force in Kurdistan, and overt political activism had been neutralised. Those who split from the Central Committee of the KDP were appointed to the Executive Council, with Hashim Aqrabi chairing it. The GOI moved quickly to secure its hold on Iraqi Kurdistan. A security belt was created along the Iranian and Turkish borders to an eventual width of 30 kilometres, and villages within the belt were systematically destroyed, with 600,000 people being deported to the collective towns, or to southern Iraq. A policy of arabization was enforced, particularly in Kirkuk, and a policy of assimilation was encouraged.

#### **4.4 The Patriotic Union of Kurdistan**

The period after the collapse of the Kurdish Revolution can be seen as a watershed. With the loss of the omnipresent influence of Barzani from the region, and the evacuation of the KDP leadership to Iran, the field was left open for left-wing groupings. Some remnants of the KDP were active, but were now under the influence of a new leftist programme developed by new decision-makers within the party. Barzani’s sons, Idris and Massoud, kept the Barzanis tied with the KDP, but they were now joined by a new line of commanders. However, this rump of the KDP was somewhat discredited amongst the Kurdish populace, and its support was limited to the Bahdinan areas.<sup>142</sup> Meanwhile, Talabani, now in Damascus, coordinated some left-wing groupings and formed what was to become one of the major organizations

<sup>139</sup> Interview with Jalal Talabani, Kalarcholan, 5 September 2000.

<sup>140</sup> The PUK name this event the *ashbatal*, which refers to leaving a table when the food is ready for eating. The KDP do not use this term as it is, in effect, a criticism of Barzani’s actions. Interview with Jalal Talabani, Kalarcholan, 5 September 2000.

<sup>141</sup> See Catudal (1976) “The War in Kurdistan: End of a Nationalist Struggle?” *International Relations*, Vol. 5; Feili & Fromchuck (1976) “The Kurdish Struggle for Independence.” *Middle East Review* 9, No. 1 (Fall 1976), pp. 47-59.

<sup>142</sup> Sheikmous (1999) *op. cit.*, p. 56.

in Kurdish politics, the PUK, from three groups displaying varying degrees of socialist ideology.

Alongside these internal political developments, the GOI was quickly implementing the Autonomy Law of 1974, and incapacitating the ability of the *peshmerga* forces to base themselves in the mountains. The large-scale destruction of the Kurdish rural landscape commenced, with mass-deportations to the infamous collectives, and the razing of agricultural lands.

This section aims to provide a basis for an understanding of the contemporary structures and decision-making processes of the political parties. A description and analysis of the establishment of the PUK is developed, and the position of the KDP in this period similarly forwarded. It is argued that the period between 1975 and 1980 can be seen as extremely significant in the development of the contemporary situation.

#### 4.4.1 The Establishment of the Patriotic Union of Kurdistan

The PUK was officially established on 1 June 1975 with the aim of:

*“organizing the revolutionary, patriotic and democratic forces of the Kurdish people in the form of a broad democratic and patriotic front that allows the fighting unity and coexistence of the different progressive tendencies under the leadership of a Kurdish revolutionary vanguard.”*<sup>143</sup>

The declaration, signed by the Founding Committee of the PUK and originating in Damascus, signified the re-commencement of opposition against the GOI, primarily through the party organizations of *Komala* and *Bezutnawa* in Iraqi Kurdistan, with *Heshtigishti* coordinating the external affairs of the struggle.<sup>144</sup> At the establishment,

---

<sup>143</sup> Patriotic Union of Kurdistan (1977) *op. cit.*, p. 6.

<sup>144</sup> The ‘founding fathers’ of the PUK were Jalal Talabani (Damascus) and Dr Fu’ad Massoum (Damascus). They then approached Adil Morad (Tehran) and Abdel Azad Faili (Tehran / Damascus). These four met in Damascus and provisionally founded the PUK. Talabani then travelled to Berlin and contacted Nawshirwan Mustafa (Vienna), Omar Sheikmous (Stockholm) and Dr Kamal Fu’ad (Berlin). These seven wrote the Declaration of Foundation. Interviews with Nawshirwan Mustafa Amin, Suleimaniyah, 10 August 1999; Jalal Talabani, Kalarcholan, 5 September 2000.



therefore, PUK was not a unified party in the sense of the KDP, but was more of a broad semi-front.<sup>145</sup>

#### 4.4.1.1 The Origins of the PUK

Much has been written about the formation of the PUK. Most analysts state that the PUK formed as a result of the political vacuum of 1975, that the PUK was the heir to the KDP Political Bureau which split with Barzani in 1964,<sup>146</sup> and that the PUK was directed by Talabani from Damascus. Within all of these comments, there are elements of truth, yet they are far too simplistic to portray what was the formation of perhaps the most complex of guerrilla movements / political parties in Iraq. Most importantly, the PUK did not form hastily, it had a lengthy period of planning and preparation behind it, as shown by the opening statement of the Declaration of Formation:

*“The formation of PUK was not a hasty and spontaneous action, as it is asserted by certain circles, on the contrary, it, was very long-processed synthesis of a revolutionary and realistic idea about the nature of the liberation movement, that engulfs many democratic, progressive and leftist tendencies that cannot be assembled within the ranks of a single political party. The emergence of PUK was a result of a conscious awareness of the needs of a liberation movement of an oppressed nation.”*<sup>147</sup>

Furthermore, the origins of the PUK can be traced to other pervasive influences. The following three-fold division illustrates the formative influences of the PUK:

1. The impact of the Ahmed-Talabani faction, and particularly the character of Talabani;
2. The activities of other KDP Political Bureau members, and;
3. Leftist influences and the formation of political groups with a Marxist, and increasingly Maoist, ideology.

The three groupings are not discrete and the relationships between them are complex. To understand these relationships it is necessary to address the split of the KDP in 1964, the growth of left-wing ideologies in Iraqi Kurdistan, and the formation of

---

<sup>145</sup> Interviews with Mohammad Tawfiq, Kalarcholan, 7 August 1999; Jalal Talabani, Kalarcholan, 14 September 1999, 5 September 2000.

<sup>146</sup> Gunter (1999b) *op. cit.*, p. 72.

what was to become the core organization of the PUK, the *Komala*.<sup>148</sup> As the history of the genesis and development of the PUK is linked with the KDP, the following sections also provide an analysis of the KDP during the period.

#### 4.4.1.1.1 *The 1964 Division*

Some commentators have stated that the division of 1964 is the origin of the PUK, with the Political Bureau developing in opposition to Barzani. However, while it may be seen as being the first development of some form of schism, there is little to suggest that this event can fully explain the subsequent rise of the PUK. During this period, key personnel of the future PUK remained alongside Barzani, and some of the anti-Barzani men of this time later became close allies. By 1970, the problem between Barzani and the Political Bureau was effectively finished, and *Komala* was established by totally separate people to the Political Bureau.

**Figure 4.4: Constituent Groupings of the PUK**

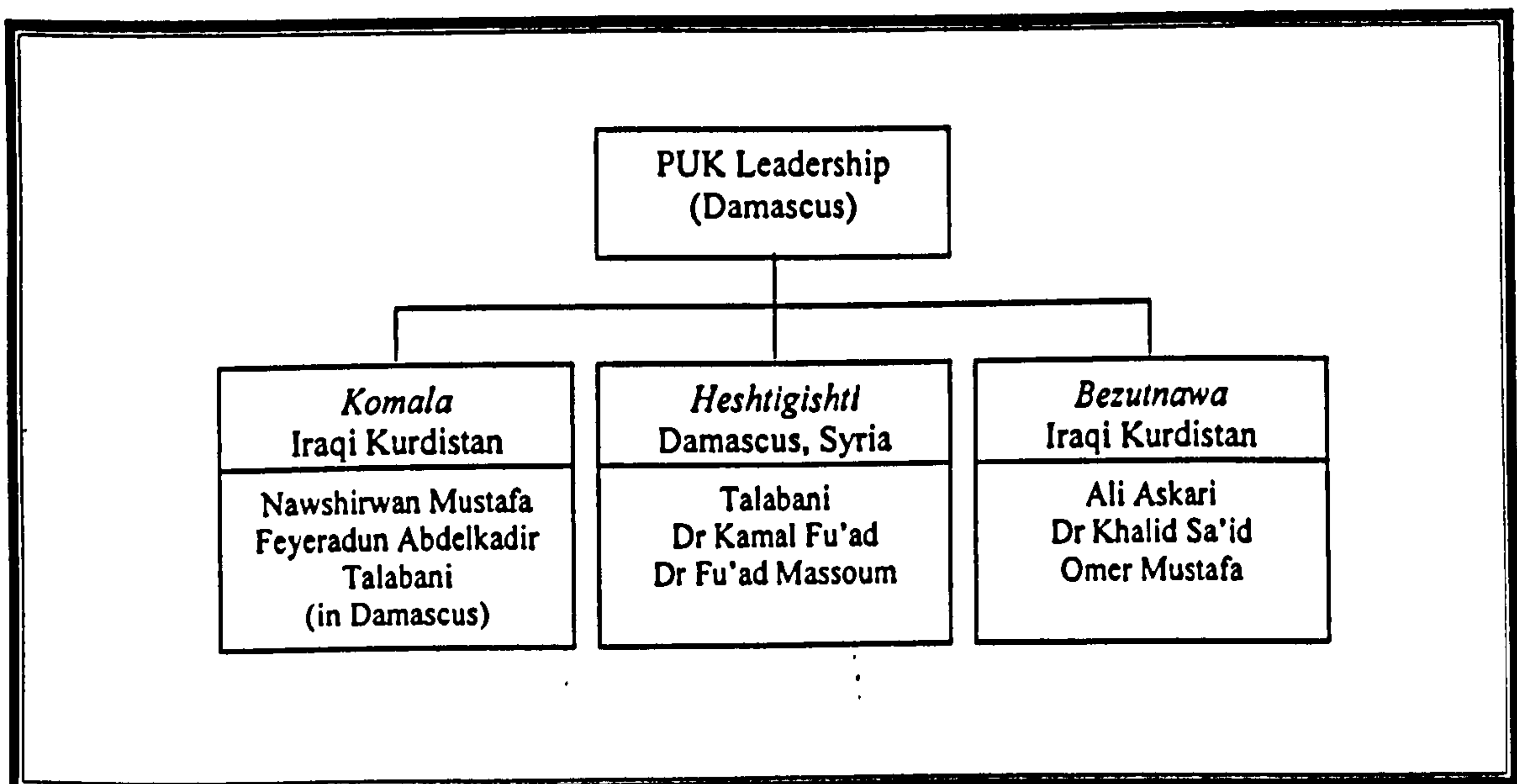

While the split of the Political Bureau is important in understanding the position of Talabani, it does not explain how he secured an increasing basis of widespread support and managed to form the PUK so quickly in 1975. Factors other than the split of 1964 must therefore be taken into consideration, particularly when it is

<sup>147</sup> Patriotic Union of Kurdistan (1977) *op. cit.*, p. 15.

<sup>148</sup> Formally known as Marxist-Leninist *Komala*.



realised that the only member of the 1964 division of the contemporary PUK in a decision-making position is Talabani.

#### 4.4.1.1.2 *The Influence of Maoist Doctrine*

During the late 1960s, young Iraqis as a whole, including Kurds, were drawn into the sphere of influence of socialist politics, with the result that political activism was coloured by left-wing ideals. However, the established set of left-wing ideology, that of Soviet Communism, was challenged by the Chinese Communists at the end of the 1960s, with the result that the Chinese Communists became known as 'Revisionists', effectively mixing communist internationalism with nationalist sentiment, leading national revolutions in a leftist manner. These changes reached Iraqi Kurdistan through left-wing parties in Iran, such as *Tafan* and *Tuda*, which were against the old-style Communist parties, and through Palestinian parties and literature.<sup>149</sup>

To young politically minded Kurds, such a combination of socialism with Kurdish nationalism proved to be highly attractive, particularly when faced with the increasing autocracy of Barzani and the infighting with the KDP Political Bureau. Feyeradun Abderkadir notes that "*the new ideologies created a basis of criticism against both wings of the KDP, arguing that none had the capabilities to make the revolution a success.*"<sup>150</sup>

The impact of Maoism on the students of Iraqi Kurdistan grew, with many of today's high-ranking cadres of the PUK originating from this period. Most notable of these cadres is Nawshirwan Mustafa who, in 1969, published his own left-wing magazine named '*Rizgary*', in which the new ideology was discussed with articles by himself and Talabani appearing.<sup>151</sup> These new ideologues were critical of both Barzani and the Ahmed-Talabani faction, yet still identified themselves with the Ahmed-Talabani faction, hence the involvement of Talabani with this group. The aims of the students appeared, at this stage, to be little more than trying to influence the KDP to adopt a

<sup>149</sup> For example, '*Al-Hadaf*' published by the Palestinian Liberty Front. (Nuri (1998) *My Memories in the Komala Organization, 1971-1983*. Suleimaniyah, p. 5). Interviews with Feyeradun Abdelkadir, Suleimaniyah, 10 August 1999; Nawshirwan Mustafa Amin, Suleimaniyah, 10 August 1999.

<sup>150</sup> Interview with Feyeradun Abdelkadir, Suleimaniyah, 10 August 1999.

<sup>151</sup> Nawshirwan Mustafa owned *Rizgary*, and it was edited by Shafiq Sayigh (Interview with Nawshirwan Mustafa Amin, Suleimaniyah, 10 August 1999). A further influential newspaper

socialist line rather than to promote a deeper, more militant, split. However, they would have a profound impact upon the direction of the Kurdistan national struggle within Iraq, and within the future PUK.

#### 4.4.1.2 The Formation of Komala

*“To understand the PUK, you have to first understand the Komala.”*<sup>152</sup>

The student groupings of Iraqi Kurdistan in the late 1960s were therefore influenced by three separate but interrelated inputs:

1. The polarization of Iraqi Kurdish politics between Barzani and the Political Bureau;
2. The introduction of new radical ideas, particularly Maoism, and;
3. The involvement of Talabani with this new way of thinking and his involvement with the training of party cadres in these new ideas.

The signing of the March Agreement of 1970 proved to be a catalyst in the thinking of these young radicals. They decided that the Ba’ath Party could not implement such an agreement, and Barzani was certainly in no position to force them, with the result that a ‘third way’ was increasingly discussed.<sup>153</sup> In May 1970 representatives of the Students’ Union, including Feyeradun Abdelkadir, held discussions with Talabani. It was agreed to establish a new, covert, Maoist-style party, but Talabani insisted that other groupings should be approached. The resultant discussions, which included Nawshirwan Mustafa, Feyeradun Abdelkadir and Fu’ad Keraki, led to the formation of *Komala*.

The first meeting of *Komala* took place in the Baghdad residence of Feyeradun Abdelkadir on 10 June 1970.<sup>154</sup> The operations of the *Komala* were intensely secretive as, not only were they in opposition to the GOI, they could not afford to

---

espousing similar political viewpoints was *Hawkarl*, which included the involvement of Shaswad Jalal (Martyr Aram) and Fu’ad Qaradaghi. (Nuri (1998) *op. cit.*, p. 4).

<sup>152</sup> Interview with Shwan Qliasani, Suleimaniyah, 4 August 1999.

<sup>153</sup> Interview with Nawshirwan Mustafa Amin, Suleimaniyah, 10 August 1999.

<sup>154</sup> Those present were Talabani, Shahab Sheikh Nuri, Fu’ad Keraki, Faza Mulla Mahmoud, Dler Sadiq, Rafad Mulla, and Feyeradun Abdelkadir.



allow Barzani and the KDP realise the extent of Talabani's involvement with such a potential powerful grouping as left-wing students.<sup>155</sup>

#### 4.4.1.2.1 *The Early Organizational Structure of the Komala*

The result of the first meeting was a decision to expand the membership of the *Komala* in an attempt to strengthen the fledgling organization. Secret cells commenced operations with the intention of recruiting new revolutionaries.<sup>156</sup> In this first month of work, the cells recruited 200 people in Baghdad, over 200 in Suleimaniyah, and between 30 and 40 in Erbil. These new cells (*shana*) were organised in groups of between 3 and 5, with only one person knowing the person above. At this point, the aims of these groups was purely to indoctrinate the members with the teachings of Mao Tse-Tung and left-wing nationalism. This early structure of the *Komala* was headed by a leadership composed of the original 7 cadres of the 10 June meeting, with Talabani being elected, in secret from the KDP, as the Secretary-General of the organization. The *Komala* accepted the peace between the Barzani wing and the Ahmed-Talabani faction, but to the leadership it became apparent that a gap had developed which *Komala* itself would try to fill.<sup>157</sup>

#### 4.4.1.2.2 *Ideological Divisions within the Komala*

The transition from Old-Communism to the new Revisionism proved to be a task not devoid of difficulty. Indeed, the division between the two groups which commenced in the first year of formation of *Komala*, characterised the internal political dynamics of the PUK throughout the 1980s. Some members of the *Komala*, headed by Faza Mulla Mahmoud and Fu'ad Keraki wanted the new organization to follow the Old Communist line of Iraqi Nationalism, the others, led by Talabani and Shahab Sheikh Nuri wanted to follow the Revisionist line. The rapprochement between the Ahmed-Talabani faction and Barzani in 1970 removed the urgency of the disagreement with Talabani being posted to Beirut and then Damascus by the KDP in 1972. However,

---

<sup>155</sup> Interview with Feyeradun Abdelkadir, Suleimaniyah, 10 August 1999.

<sup>156</sup> Of these new secret cells, the most important were those led by Martyr Aram (a code-name for one of the most important covert operatives of the Kurdish national movement in Iraq, Shaswad Jalal), Ibrahim Aso, Jafar Abdulwahid, and Ano Zurab (Interview with Feyeradun Abdelkadir, Suleimaniyah, 10 August 1999).

<sup>157</sup> Interview with Nawshirwan Mustafa Amin, Suleimaniyah, 10 August 1999.

he noted that this division remained with the *Komala* and, even after the *ashbatal*, a division existed with some members still wanting conciliation with the GOI.<sup>158</sup>

#### 4.4.1.2.3 *The Komala and the Formation of the PUK*

At the beginning of 1975, Talabani sent a letter to the leadership of the *Komala* pushing for the formation of a union of leftist parties. *Komala*, this time, agreed.<sup>159</sup> Before the plans could be put into action, the Algiers Agreement occurred and the left-wing Kurdish parties had immediate decisions to make about their future role. On 19 March, Barzani told all armed Kurds to hand in their weapons. *Komala* refused and on 18 March a meeting of all *Komala* leaders was held at the village of Qela near Penjwin, with 49 cadres in attendance, where it was decided to continue with the Revolution.<sup>160</sup> Fearful of being destroyed by the chaos of the *ashbatal* the leadership decided that a delay had to take place, otherwise the *Komala* would get sucked into the collapse.<sup>161</sup>

When people started returning to the cities on 23 March, *peshmerga* were sent to Kirkuk<sup>162</sup>, Koysanjaq<sup>163</sup>, Qaradagh and Suleimaniyah<sup>164</sup>, Sharazur-Halabja<sup>165</sup>, Erbil<sup>166</sup>, and Bahdinan.<sup>167</sup> These mobilizations are behind the claim that the PUK was the first party to re-establish the revolution in Iraqi Kurdistan – a claim vociferously denied by the field commander of the KDP at this time, Sami Abdul Rahman, who claimed that KDP returned on 26 May 1976, and the PUK had still not fired a shot in anger until 1977.<sup>168</sup>

<sup>158</sup> Interview with Jalal Talabani, Kalarcholan, 5 September 2000.

<sup>159</sup> Talabani had previously sent a similar letter in 1972, but the leadership of *Komala* rejected it (Interview with Feyeradun Abdelkadir, Suleimaniyah, 10 August 1999).

<sup>160</sup> Nuri (1998) *op. cit.*, pp. 7-8.

<sup>161</sup> At this time, it is estimated that over 150,000 KDP *peshmerga* were withdrawing.

<sup>162</sup> Led by Ali Peshkar, Azad Hawrami, Ali Saleh, Hami Destor, and 'Beston'.

<sup>163</sup> Led by Abdel Razaq and Mohammad Karim.

<sup>164</sup> Led by Sirwan Talabani and Mulla Ahmed.

<sup>165</sup> Led by Wasta Anwar.

<sup>166</sup> Led by Jafar Abdelwahid and Qadr Qabat.

<sup>167</sup> Led by Ibrahim Aso (all positions named by Feyeradun Abdelkadir, Suleimaniyah, 10 August 1999).

<sup>168</sup> Sami Abdul Rahman is extremely critical of the role played by *Komala*, stating that the aim of their cadres to introduce Maoism to the Kurds resulted in villagers ridiculing them. For notes on the return of the *peshmerga*, see Bulloch & Morris (1992) *No Friends but the Mountains: The Tragic History of the Kurds*. London: Penguin Books, p. 148 (interview with Sami Abdul Rahman, Salahadin, 27 June 1998).



At this point, *Komala* was operating independently of other militias but decided to accept the proposal of Talabani for it to come under the umbrella of the PUK. Feyeradun Abdelkadir travelled to Damascus to inform Talabani of the decision. It was agreed that a leadership should also be established in Kurdistan, which would include Ali Askari (at the time exiled in Nasiriya), Dr Khalid Sa'id, Shahab Sheikh Nuri, Shazad Sayigh, Omar Mustafa, Rasoul Mamand and Feyeradun Abdelkadir. At the time, these names were a mix between *Komala* members and other famous figures within the national movement.<sup>169</sup>

#### 4.4.1.2.4 *The Komala Leadership*

Messages were sent to Ali Askari in Nasiriya, Jafar Abdelwahid in Koysanjaq, and Dr Khalid Sa'id explaining the establishment of the *Komala* leadership. However, the GOI arrested the members of *Komala* and the PUK, which resulted in the incarceration of many leaders, including Shahab Sheikh Nuri, Feyeradun Abdelkadir, Omar Sa'id Ali and Jafar Abdelwahid.<sup>170</sup> Plans for the arrest were leaked to the leadership of the *Komala* which immediately identified replacements for the leadership positions. These included Azad Hawrami, Osman Bakeri, Arsalan Bayaez, and Abu Shahab.<sup>171</sup> The targeted men then went into hiding in Iran but were handed back to Iraq where three of them (Khala Shahab, Anwar Zorab, and Ja'afar Abdulwahid) were executed.<sup>172</sup> Martyr Aram continued to operate for *Komala* covertly and established a *Comita* of the *Komala* in each urban area.<sup>173</sup>

---

<sup>169</sup> Interview with Feyeradun Abdelkadir, Suleimaniyah, 10 August 1999.

<sup>170</sup> Of these members, Omar Sa'id Ali would later go onto being a PUK Political Bureau member and head of the PUK Branch of Suleimaniyah (*Melbendi Yek*).

<sup>171</sup> Of these members, Arsalan Bayaez would later go onto being a PUK Political Bureau member, head of PUK Central Organization Office (*Maktabi Reckhrastin*) and Minister of Education in the Third Cabinet (Suleimaniyah).

<sup>172</sup> Ibrahim Aso, a further member of the leadership of the *Komala*, managed to escape through Bahdinan, and was the first to return with *peshmerga* under the PUK name on 1 June 1976. (Nuri (1998) *op. cit.*, p. 13). Interview with Jalal Talabani, Kalarcholan, 5 September 2000.

<sup>173</sup> It was at this time that Mulla Bakhtiyar, Azad Hawrami, Salar Aziz and Abdel Razak rose through the ranks of *Komala*. Of these members, Salar Aziz would later go onto being a PUK Political Bureau member, a founder of an opposition group to the PUK (*Alay Shoresh*), returnee to PUK, Governor of Suleimaniyah, and Minister of Agriculture. Mulla Bakhtiyar would rise to prominence in the *Komala*,

#### 4.4.1.3 The Formation of Bezutnawa

Among the established cadres of the KDP, the events of 1964 had provided an impetus to form a party separate to the KDP. Chalaw Ali Askari, the son of Ali Askari, the leader of this grouping, stated that:

*“There was a long period of misunderstanding between Barzani and the Political Bureau of the KDP. Since 1963, Barzani always wanted agreement with the GOI, but the Political Bureau was against this. The Political Bureau was expelled to Iran in 1964, including Ali Askari, for 17 months. When they returned, Barzani tried to assassinate Ibrahim Ahmad, Talabani, Omer Mustafa, and Ali Askari. They fled, regrouped, and started to think about establishing another party.”*<sup>174</sup>

After the collapse of the revolution, Ali Askari, Omer Mustafa, Dr Khalid Sa'id, Sa'id Kaka, and Sa'ad Aziz were contacted by Talabani from Syria via *Komala* regarding the establishment of the PUK.<sup>175</sup> However, Askari would only recommence the fighting with the permission of Barzani, who he considered to be the only leader capable of leading a unified movement. Barzani's response was resolute. He would not see the recommencement of the revolution, and went as far as to say that he would fight against Askari if he chose to take up arms against the GOI.<sup>176</sup>

Unperturbed, Askari set about establishing his own political grouping independent of the KDP, *Bezutnawa* (SDM), in 1975.<sup>177</sup> The natural support base of this organization was the leftist cadres of the KDP who had felt concerned at the actions of Barzani in 1964, and who had remained in Iraqi Kurdistan with the Ahmed-Talabani faction. Askari requested all the politically active peoples who had fled to Iran with the *ashbatal* to return and join the SDM. This movement can therefore be seen as complementary to the younger more radical *Komala* membership, and, indeed, relationships between the two groupings were characterised by mutual

---

before similarly forming the opposition movement *Alay Shoresh* and then return to the PUK as head of the Office of Democratic Organizations. (Nuri (1998) *op. cit.*, p. 14).

<sup>174</sup> Interview with Chalaw Ali Askari, Suleimaniyah, 10 June 1998.

<sup>175</sup> Interview Jalal Talabani, Kalarcholan, 5 September 2000. McDowall (1996) *op. cit.*, p. 364.

<sup>176</sup> Interview with Chalaw Ali Askari, Suleimaniyah, 10 June 1998.

<sup>177</sup> *Bezutnawa* roughly translates as “movement” which is short for Social Democratic Movement (SDM). Interview with Mohammad Tawfiq, Kalarcholan, 7 August 1999.



respect and cooperation. *Komala* enjoyed better organization than *Bezutnawa*, but *Bezutnawa* commanded a wider support base and was a more populist party.<sup>178</sup>

#### 4.4.1.4 Operational Structure of the PUK

The early operations of the PUK were divided according to the divisions of *Komala* and *Bezutnawa*, with *mafareza* of both organizations operating independently. Each group had a discrete clandestine organization. Due to the ideological basis of *Komala*, and its 5-year history, its organizational structure was copied by *Bezutnawa*.<sup>179</sup> Figure 4.5 illustrates the structure of *Komala* and *Bezutnawa*.

The *reckhraw* performed a political role, including intelligence gathering, and implementing political decisions. The *kart* organization was essentially for the *peshmerga*, but there were also *reckhraw* for the *peshmerga* as well.<sup>180</sup> While the *mafareza* remained part of the respective party organizations, there was a certain degree of coordination provided by the PUK. At the level of leadership of the PUK, each organizational wing, *Komala*, *Bezutnawa* and *Heshtigishti*, forwarded representatives which composed the PUK Political Bureau. Talabani returned to Iraqi Kurdistan in 1977 to promote morale in the fledgling PUK, and set up his headquarters inside the Iranian border at Nawkan and in Iraqi Kurdistan at Qandil, from where he could direct the operations of *Komala* in Suleimaniyah, and *Bezutnawa* further west.<sup>181</sup> Furthermore, he established instituted procedures to formalise the *peshmerga* structure, commencing with appointing Ali Askari as *Peshmerga Commander*.<sup>182</sup>

The influence of Maoist doctrine on the Kurdish liberation movement is evidently clear. Talabani divided the *peshmerga* into *harams* (regiments), and each district (*qadha*) of Iraqi Kurdistan was allocated a *haram*. The organization of the *haram* was fluid, if the *qaza* was controlled by the *haram* then the *peshmerga* would establish a permanent base, otherwise, they would operate as a mobile *haram* and attack the forces of the GOI by night. The leaders of each *haram* constituted the

<sup>178</sup> Interview with Chalaw Ali Askari, Suleimaniyah, 10 June 1998.

<sup>179</sup> Interview with Mohammad Tawfiq, Suleimaniyah, 14 May 1998.

<sup>180</sup> *Ibid.*

<sup>181</sup> *Komala* would remain reasonably inactive in Erbil until the arrival of Kosrat Rasoul in the 1980s.

<sup>182</sup> Interview with Jabar Farman, Suleimaniyah, 18 June 1998.

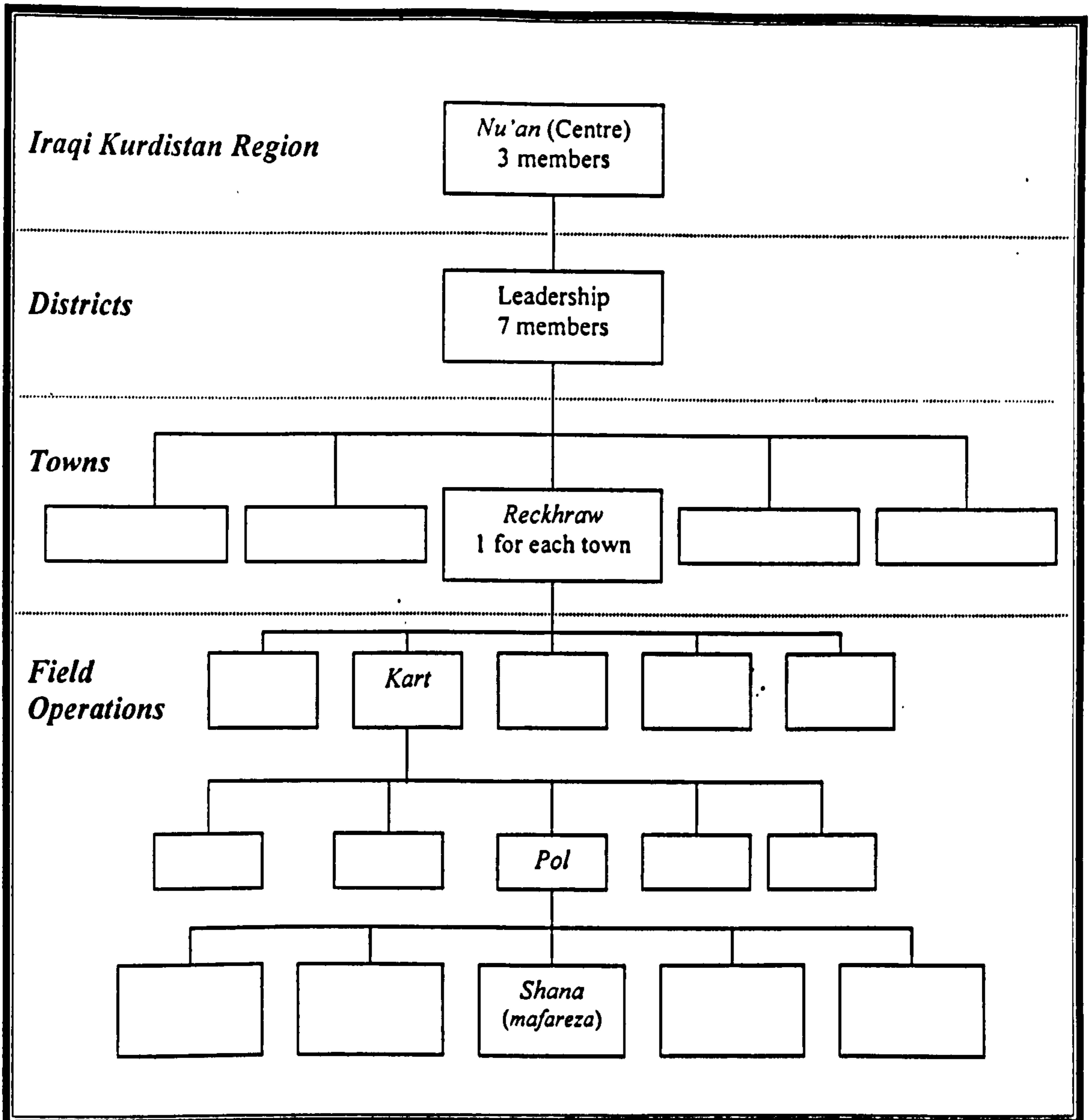
**Figure 4.5: The Hierarchy of *Komala* and *Bezutnawa*<sup>183</sup>**

Leadership Office of the PUK, and, due to the distribution of the various wings of the PUK, each faction would have approximately 6 members office. The Political Bureau was less systematically constructed, with 2 members simply being appointed from each party.<sup>184</sup>

The composition of the PUK allowed it to generate a great deal of popular support upon its formation. The three parties within the umbrella of the PUK represented

<sup>183</sup> *Ibid.*

<sup>184</sup> Interview with Dr Kamal Khoshnaw, Suleimaniyah, 13 May 1998; Interview II with Jabbar Farman, Suleimaniyah, 18 June 1998.



three major groupings of the populace of Iraqi Kurdistan. *Heshtigishti* was a natural focus for the more established intelligentsia; *Komala* was attractive for the new style of nationalists inspired by the teachings of Mao, and *Bezutnawa* became increasingly associated with the middle classes.

By 1977, the PUK had developed mass democratic organizations of different groups of people (e.g. farmers, students) which would later develop into the representative structure of the 1990s PUK.<sup>185</sup> At this time, the KDP had little else but a belief in the figure of Barzani and the strength of a certain few tribes.<sup>186</sup> However, within Iraqi Kurdistan, such loyalty to a charismatic leader and family was powerful and the strength of the KDP as a political and military force that enjoyed strong, if localised, popular support could not be underestimated.

#### 4.4.1.5 Conclusion

The origins of the PUK can be traced to several inter-related factors. The original division within the KDP between the Barzani-wing and the Ahmed-Talabani faction is obviously a strong factor, but this division was more of a reflection of the division within Kurdish society rather than a planned schism. While its importance is great, one has to look elsewhere for other formative elements, particularly as even in the 1964 and 1966 split, the cadres who would go on to form the PUK had not yet emerged.

The growth of left-wing political ideas, culminating in the establishment of *Komala* is a further important factor. It is from this organization that the majority of the current PUK leadership originate, that the structure of the PUK originated, and the left-wing ideals of the party nurtured. The PUK was dependent upon the organization of *Komala* as it was the only political grouping operating on a reasonably large scale within Iraqi Kurdistan. The *Komala* represented the young radically minded Kurds, many of whom were students at the time.

Similarly, the PUK was dependent upon *Bezutnawa* because of its wide support base amongst a slightly older generation which followed a less extreme brand of

---

<sup>185</sup> Interview with (Hackam) Khadr Hama Jan, Suleimaniyah, 6 September 2000.

socialism, thereby remaining attractive to those Kurds of a more conservative nature. This factor is reflected in the zones of operation of the factions, with *Bezutnawa* operating more freely in the Bahdinan out of the Baradost region (the traditional tribal heartland), and *Komala* operating out of Suleimaniyah.<sup>187</sup> However, the relationship between *Komala* and *Bezutnawa* was strong.<sup>188</sup>

The impact that *Komala* has had on the political development of Iraqi Kurdistan can be seen to be significant. The majority of the decision-makers of the PUK were originally members. However, the extreme leftist sentiment which characterised their actions from the outset, combined with their rejection of the right of an individual family, the Barzanis, to head the Kurdish national movement, magnified the divisions which existed between urban and rural areas, and particularly between the Suleimaniyah and Bahdinan regions. This enhanced segmentation of Iraqi Kurdistan is apparent today and is a major obstacle to the unification of the region and administration.

#### 4.5 The KDP and PUK in the Aftermath of the *Ashbatal*

After fleeing to Iran in 1975, the KDP returned to Iraqi Kurdistan on 26 May 1976, under the name of Kurdistan Democratic Party–Provisional Leadership (KDP-PL).<sup>189</sup> Figure 4.6 illustrates the progression of events during this period. The reformation of the KDP so soon after the collapse of 1975 can be traced to the establishment of the PUK a year before. Possibly shocked by the speed in which Talabani had constituted the PUK, the rump of the KDP moved with urgency to return to Iraqi Kurdistan. Talabani claims that the return of the KDP was supported by SAVAK of Iran and Turkish Military Intelligence (MIT) as both were concerned with the leftist orientation of the PUK, and its ties with Syria.<sup>190</sup> However, the KDP had been severely criticized because of its evacuation, and could not exercise power over the whole region.

---

<sup>186</sup> Interview with Daoud Baghstani, Erbil, 30 May 1998.

<sup>187</sup> McDowall (1996) *op. cit.*, p. 343.

<sup>188</sup> Interview with Dr Kamal Khoshnaw, Suleimaniyah, 13 May 1998.

<sup>189</sup> At the same time, a further organization established itself within Iraqi Kurdistan. The Kurdistan Democratic Party – Preparatory Committee (KDP-PC) was led by the previous Secretary General of the KDP, Dr Mahmoud Othman (McDowall, 1996, p. 344; interview with Sami Abdul Rahman, Salahadin, 27 June 1998; See Besifki (1996) *The Kurdish National Liberation Movement Since 1975: Success or Failure?* Unpublished PhD thesis, University of Southampton, p. 149.

<sup>190</sup> Interview with Jalal Talabani, Kalarcholani, 5 September 2000.

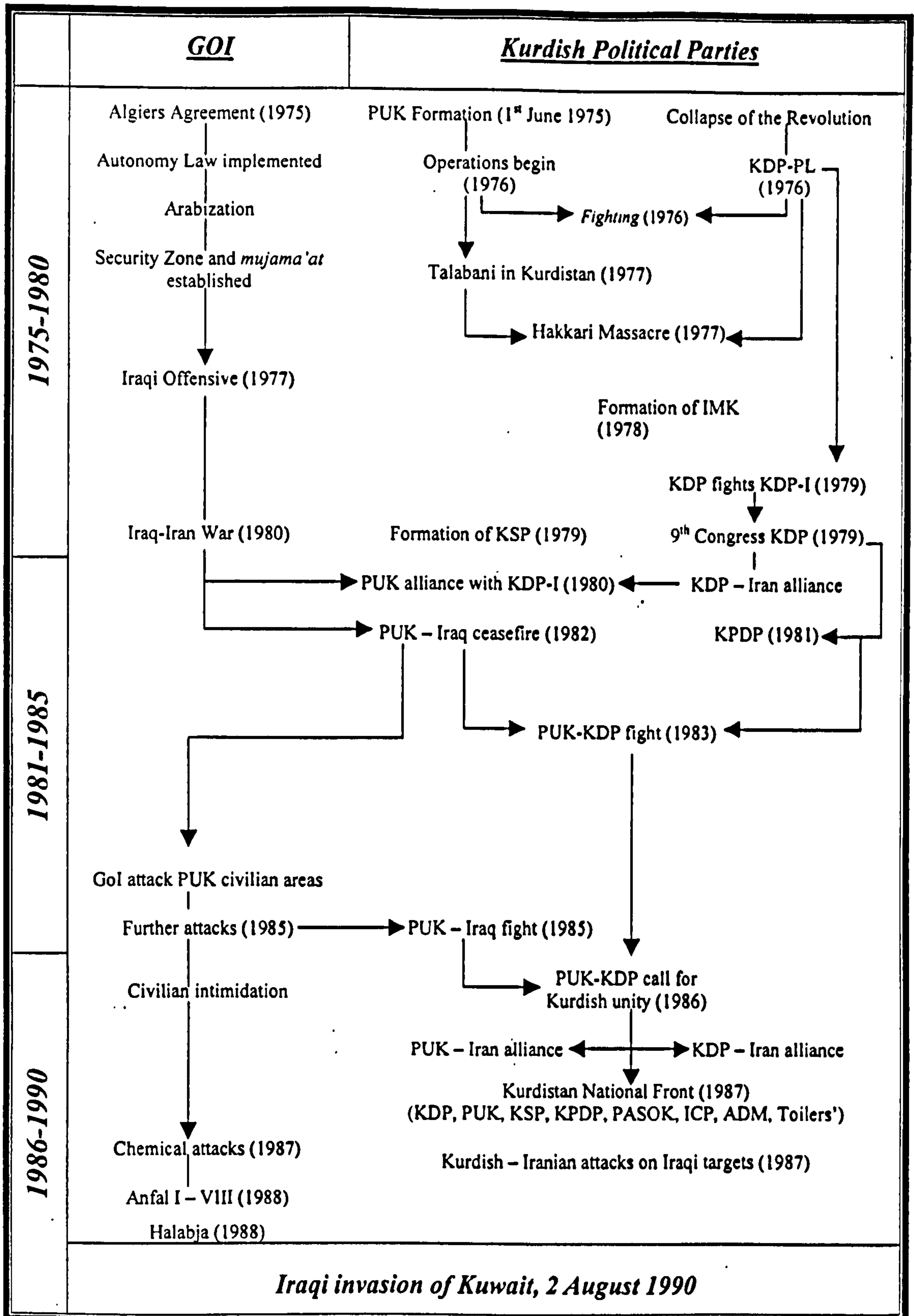

Figure 4.6: Chronology of Events, 1975-1990<sup>191</sup>

<sup>191</sup> Sources: Ghareeb (1981) *op. cit.*; O'Ballance (1996) *op. cit.*, pp. 74-163; McDowall (1996) *op. cit.*, pp. 323-339; Ghafour (1997) *op. cit.*, pp. 18-41; Key as for Figure 4.1.

The withdrawal of Barzani from the immediate political scene caused a major problem in the decision-making process of the KDP-PL, with new leaders surfacing in an unstable political climate. It is during this period that the figure of Sami Abdul Rahman comes to prominence. Sami, previously close to Barzani, had been the Minister of Northern Affairs in the 1970 cabinet of the GOI, and a member of the Political Bureau. With the collapse of the revolution in 1975, Sami was elevated to commander of the organization within Iraqi Kurdistan. Idris established his faction in Iran, and Massoud did not fully return to Iraqi Kurdistan until the death of his father in 1979.<sup>192</sup>

#### 4.5.1 The Power Struggle Within the KDP-PL

Tensions within the KDP-PL leadership, similar to the previous problems which existed between the Ahmed-Talabani faction and the Barzani-wing of the KDP, surfaced. This time, the traditionalist-wing was led by Barzani's son, Idris, and the leftist-wing can be identified as being led by Sami Abdul Rahman. The position of Sami at this time is interesting, particularly when his later positions of Political Bureau member and Deputy Prime Minister are taken into account. At the time, Sami noted that there was a need to replace the party which had failed the Kurdish people. Besifki notes that "*for Abdul Rahman and the other 'progressives' and the 'frustrated', the alternative was a proletarian leadership and party.*"<sup>193</sup>

Although this may seem to be initially difficult to understand when faced with the current situation, in the *Revolutionary Alternative*, Sami presents a scenario which shows an acceptance of Massoud by most of the factions within the KDP-PL.<sup>194</sup> However, Sami contends that Idris was plotting with 'reactionary' forces to capture the leadership for himself. With the assistance of the new Islamic regime in Iran, Idris commenced with the recruitment of *peshmerga* from Barzani refugees on the border, and near the end of May 1979 began advocating the importance of the Barzani family in leading the KDP, opening a campaign to discredit the leftist intellectuals.<sup>195</sup>

<sup>192</sup> McDowall (1996) *op. cit.*, p. 344.

<sup>193</sup> Besifki (1996) *op. cit.*, p. 150, quoting Abdul Rahman (1981) *Al-Badiel Al-Thawry fi Al-Harakah Al-Taharuryah Al-Kurdiyah* (Revolutionary Alternative in the Kurdish Liberation Movement), p. 19.

<sup>194</sup> Abdul Rahman (1981) *Al-Badiel Al-Thawry fi Al-Harakah Al-Taharuryah Al-Kurdiyah*.

<sup>195</sup> Besifki (1996) *op. cit.*, p. 150, quoting Abdul Rahman (1981) *op. cit.*, p. 31.



The power-struggle between Idris and Sami, with Massoud in the middle, came to a head in a meeting of the KDP-PL in the village of Shanawa. According to Sami, three factions emerged; the reactionary right wing (led by Idris), the progressive faction (led by Sami), and the centrists (led by Massoud). The meeting, which saw Massoud faced with an obvious dilemma, elected Massoud as provisional leader, established the Political Bureau, and chose Sami as Secretary-General.<sup>196</sup>

#### 4.5.2 The Hakkari Massacre

An event which was to have profound ramifications for the future of Iraqi Kurdish politics, and in particular the lack of trust within the system, took place in 1978. With so many individual *mafareza* operating in Iraqi Kurdistan, and so many opportunities for political advancement apparent to the leaders in the vacuum of the *ashbatal*, it was not too surprising that a major confrontation between different Kurdish groupings would take place. The disastrous feud which had taken place between Barzani and Talabani resulted in Talabani ordering *mafareza* of the PUK to attack the KDP-PL at any opportunity. The KDP commander, Sami Abdul Rahman, similarly was in “*no mood to deal softly with such enemies and was backed by Idris who bore a visceral hatred for Talabani*”.<sup>197</sup>

##### 4.5.2.1 Chronology of Events

In April 1978, Talabani sent Ali Askari and his deputy in *Bezutnawa*, Dr Khalid Sa'id, on a mission to pick up arms from Kurdish villages just inside the Turkish border. Talabani gave Askari written orders to destroy KDP-PL bases *en route*, an order which Askari ignored since he had already established a close working relationship with the KDP-PL in the Baradost area.<sup>198</sup> However, the orders manifested themselves to Sami who decided to act decisively.

After being weakened by both Iraqi and Iranian air and ground forces, the forces of *Bezutnawa* divided at Baradost. Askari made contact with the KDP-PL in Baradost as had happened previously, expecting no hostility. However, when he marched into Hakkari in Turkey, his forces were ambushed by a large formation of KDP

---

<sup>196</sup> *Ibid.*

<sup>197</sup> McDowall (1996) *op. cit.*, p. 344.

<sup>198</sup> *Ibid.*, p. 345.

*peshmerga* and surrendered after heavy losses. A similar fate befell the force of Dr Khalid. Both Ali Askari and Dr Khalid Sa'id were executed, some say on the orders of Sami, some on the orders of the Barzanis.<sup>199</sup>

#### 4.5.2.2 Analysis of the Hakkari Massacre

To analyse the Hakkari Massacre produces several informative insights into the political history of Iraqi Kurdistan, the development of the key political characters, and assists in understanding the decision-making process and hierarchy of power within the KDP and PUK in the 1990s.

Ali Askari was a politician who had enjoyed a long history with the KDP and, unlike most other political leaders, had the ability to galvanise support around him. Similarly, Askari was well respected as a *peshmerga*.<sup>200</sup> These factors meant that he was a threat to many other politicians of the left in particular.<sup>201</sup> A possible hypothesis based on these facts would therefore be that Ali Askari was killed by a conspiracy of leftist politicians who saw him as either being a threat within the organization he was already in (PUK), or occupying a political position deemed attractive by a potential adversary.

McDowall hints at the first possibility and notes that many cadres within the PUK at the time believed that Talabani may have sent Ali Askari to his death by collaborating with the KDP-PL.<sup>202</sup> It was certainly the case that the KDP-PL were consistently one-step ahead of the doomed *Bezutnawa*.<sup>203</sup> The second possibility focuses on Sami. After this affair, Sami split from the KDP and his writings indicate

---

<sup>199</sup> McDowall states that Ali Askari and Dr Khalid Sa'id were executed on the orders of Sami Abdul Rahman (*ibid*), however, Sami states that the order came from the Barzanis (interview with Sami Abdul Rahman, Salahadin, 3 April 1998). This was bad enough for intra-Kurdish relations, however, the reported manner in which Ali Askari was executed, by an RPG-7, made the matter even more serious. Other commentators have attributed the action of the KDP as avenging the killing of several of Barzani's nephews some months previously by the PUK *peshmerga* commander, Kamal Mufti. Whether true or false, this affair has reached a level of folklore within Iraqi Kurdistan.

<sup>200</sup> Interview with Chalaw Ali Askari, Suleimaniyah, 10 June 1998.

<sup>201</sup> *Ibid*.

<sup>202</sup> When I asked Talabani about this supposed involvement, he simply laughed and dismissed it. Interview with Jalal Talabani, Kalarcholan, 5 September 2000.

<sup>203</sup> McDowall (1996) *op. cit.*, p. 364.



his move to the left.<sup>204</sup> To do this effectively he needed to remove Ali Askari to control the popular support base occupied by *Bezutnawa*.<sup>205</sup>

Chalaw Ali Askari developed this hypothesis by broadening its scope. According to Chalaw, the USSR had asked to see Ali Askari at the Soviet Embassy in Lebanon as they had identified him as being the route by which the USSR would become more involved in Iraqi Kurdistan. The US, extremely concerned about the potential increase of the involvement of the USSR in Iraqi Kurdistan at this time, sent the Barzanis against Askari. Chalaw believes that this would explain the advantages the KDP-PL forces had in terms of intelligence, coordination with Turkish and Iranian military units, and the mobilization of tribal forces. A similar conspiracy theory, was forwarded by the Deputy-Commander of PUK *Peshmerga*, Jabar Farman, who was a *Komala peshmerga* at this time;

*“The whole incident was planned by the KDP, Turkey and Iran in an attempt to destroy the PUK. The left-wing ideology of the PUK frightened many surrounding countries who did not feel at ease with its Marxist – Maoist viewpoints.”*<sup>206</sup>

To further complicate the situation, Chalaw recalls that, after the killing, Massoud attended the funeral of Ali Askari and insisted that he know nothing about conspiracies to eliminate him. However, he reportedly admitted that it was a killing for political issues.<sup>207</sup>

#### 4.5.2.3 The Impact on the Political System

The impact of the Hakkari Massacre had far-reaching ramifications for the political system. Faced with the loss of 3 skilled commanders (Ali Askari, Dr Khalid Sa'id, and Sheikh Yazdi) along with approximately 700 *peshmerga*, and the rump of *Bezutnawa*, the PUK was forced into an extensive period of reorganization.

<sup>204</sup> Interview with Chalaw Ali Askari, Suleimaniyah, 10 June 1998.

<sup>205</sup> Chalaw Ali Askari, the son of Ali Askari, favoured this interpretation and would not accept any possibility of the involvement of Talabani in the death of his father. The relationship between Chalaw and Talabani is very close. Indeed, Chalaw is influential within the PUK and has had positions ranging from Deputy-Minister of Humanitarian Affairs to private adviser to Talabani on political issues. Chalaw supports his argument by referring to evidence obtained while operating for the PUK covertly against the KDP, including the retrieval of the diaries of Idris and Sami from the period.

<sup>206</sup> Interview with Jabar Farman, Suleimaniyah, 30 August 1998.

<sup>207</sup> Interview with Chalaw Ali Askari, Suleimaniyah, 10 June 1998. Nawshirwan Mustafa notes that Sami was ordered to undertake the act by Barzani himself (Amin (1999) *op. cit.*).

Political ramifications were equally serious, with the resulting splits in the socialist part of the PUK severely weakening the party. Rasoul Mamand, increasingly disillusioned, led some of the surviving *Bezutnawa peshmerga* out of the PUK and allied them with the KDP-PC of Mahmoud Othman, forming the Kurdistan Socialist Party (KSP).<sup>208</sup> With the demise of *Bezutnawa*, the PUK did not possess a focal point for the moderate-left of the Kurdish populace. Therefore, the radically-orientated *Komala* no longer had a calming counterbalance within the umbrella of the union.

Talabani embarked on a strategy of reorganising the union both in terms of structure and the introduction of new personnel, with the result that the 1980s saw the rise of many of today's decision-makers within the PUK, and the increasing dominance of *Komala*. Whether Talabani was involved or not with the Hakkari Massacre, he certainly benefited from the vacuum which developed within the decision-making structure of the PUK, and by the fact that popular opinion drastically turned against the KDP. The ramifications for the future of the events of this short period are still felt in the contemporary political system. The Hakkari Massacre is part of the folklore of the region, and some believe that the PUK will never forgive the KDP for its actions in 1978.

#### 4.5.2.4 *The Aftermath of the Hakkari Massacre*

After the Hakkari massacre, the age-old divisions within the party polarized, with the right-wing of Idris operating independently of the KDP-PL and collaborating with the Iranian forces against the KDP-I.<sup>209</sup> According to Sami's account, Massoud's position similarly moved towards supporting his brother and, in the Ninth Congress of the KDP which took place of 4 October 1979, the party split with Sami's faction becoming "*increasingly dissatisfied with the traditionalism implicit in Barzani leadership and its supporters*" and leaving the party and the leadership of the KDP

---

<sup>208</sup> Chalaw Ali Askari noted that, while the defection of the rump of *Bezutnawa* with Rasoul Mamand had a detrimental effect on the operational status of the PUK, it conversely strengthened the organization which now had fewer dissenting voices (interview with Chalaw Ali Askari, Suleimaniyah, 10 June 1998; McDowall (1996) *op. cit.*, p. 345).

<sup>209</sup> Besifki (1996) *op. cit.*, p. 150, quoting Abdul Rahman (1981) *op. cit.*, pp. 36-39; McDowall (1996) *op. cit.*, p. 346.



reverting fully to the Barzani brothers and, upon the death of Idris, to Massoud himself.<sup>210</sup>

This congress, the first to take place since the death of Barzani, was described by Massoud as being “*the most difficult and burdensome congress*”.<sup>211</sup> The progressive faction, led by Sami, went on to form the Kurdistan Popular Democratic Party (KPDP or *Parti Gel*) and Sami became a vociferous opponent of the dominance of the Barzanis in the political system of Iraqi Kurdistan.<sup>212</sup>

#### 4.5.3 The Iran-Iraq War and the *Anfal* Campaign

On 22 September 1980, Saddam Hussein launched a full-scale offensive against Iran.<sup>213</sup> The initial offensive, focused in the south of the country, stalled and resulted in a conflict which would last eight years.<sup>214</sup> This war saw the internationalisation of the Iraqi Kurdish struggle with inputs capable of making a difference to the strategic map and balance-of-power of the Middle East.<sup>215</sup>

The Kurdish parties were thrown into the frontline with the commencement of hostilities. They found themselves in a position to benefit from the fighting by acting as proxies for the combatant countries, a situation in which they have found themselves ever since. The subsequent success of the Iranian-Kurdish collaboration led to Iraq resolving to more lethal counter-measures, culminating in the use of chemical weapons in 1987, and the infamous *Anfal* Campaigns of 1988. It is estimated that perhaps as many as 100,000 noncombatant Kurds were killed in 1988.

---

<sup>210</sup> The name of the party also reverted back to KDP (McDowall (1996) *op. cit.*, p. 346).

<sup>211</sup> Kurdistan Democratic Party (1993a) *op. cit.*, p. 17.

<sup>212</sup> Besifki (1996) *op. cit.*, pp. 150-151, quoting Abdul Rahman (1981) *op. cit.*, pp. 23-45. The relationship between Sami and the Barzanis in the late 1970s is difficult to judge. However, Sami refuses to speak in bad terms about Barzani, and claims that he was very close to him. With regard to his work, *The Revolutionary Alternative*, he states that it was an attempt to guide the party programme of the KDP, rather than attacking the Barzanis (interview with Sami Abdul Rahman, Salahadin, 27 June 1998).

<sup>213</sup> For a comprehensive assessment of the Iran-Iraq war, see Chubin & Tripp (1991) *Iran and Iraq at War*. Boulder, Colorado: Westview Press.

<sup>214</sup> Bulloch & Morris (1992) *op. cit.*, p. 151.

<sup>215</sup> Some writers have been stating that the main difference of the Iraqi Kurdish predicament in the 1990s has been the internationalization of the problem, with the input of Turkey noted in particular. However, the Kurdish problem in Iraq has had a history of internationalization.

Perhaps the most infamous use of chemical weapons, although not strictly part of the *Anfal* campaign, was at Halabja, where 5,000 people were killed in March 1988.<sup>216</sup>

The situation was further complicated by different divisions within the parties, and by their differing aims. Within the PUK, the pro-Iranian elements of the party forced the PUK throughout the period 1980-1988 to develop closer ties with Iran (the KDP was already with Iran). However, alliance between an Islamic Republic and a party influenced heavily by left-wing doctrines proved to be difficult. The problem was compounded when the Iranian forces fought the KDP-I in 1982. This act resulted in the PUK supporting the KDP-I against the Iranians and, after the spring of 1983, the Iranian Government allied itself with the KDP to attack the forces of the PUK.<sup>217</sup> Such manoeuvring between the Iraqi Kurdish factions, Iran and Iraq were common throughout the duration of the Iran-Iraq War.

The aim of this section is to present the final development of the political system in Iraqi Kurdistan before the onset of hostilities over Kuwait in 1990 and focuses on the development of the indigenous political system of Iraqi Kurdistan. For reasons of clarity, I am choosing to focus primarily on the organs of the PUK. The KDP was certainly active within Iraqi Kurdistan throughout the 1980s, but not to the same extent as the PUK. Furthermore, in structural terms, the PUK would undergo numerous changes which are important to address, whereas the KDP would remain reasonably stable under the leadership of Massoud Barzani.

---

<sup>216</sup> The events of the *Anfal* Campaign are beyond the remit of this thesis. However, it is imperative that those wishing to become familiar with the political history of Iraqi Kurdistan have to understand the impact which the *Anfal* campaign has had on everyday life, economic activity, and political parties. The demographic problems created by the *Anfal* will take Iraqi Kurdistan many years to recover from, as will the environmental and long-term health problems caused by the use of both conventional and chemical weapons. References describing the *Anfal* campaign in detail include: Human Rights Watch (1990) *Human Rights in Iraq*. New Haven, CT: Yale University Press; (1993a) *Genocide in Iraq: The Anfal Campaign Against the Kurds*. New York: Human Rights Watch; (1993b) *The Anfal Campaign in Iraqi Kurdistan: The Destruction of Koreme*. New York: Human Rights Watch; Meiselas & Whitley (1994) "The Remains of Anfal." *MERIP Middle East Report* 189, no. 24 (July - August 1994), pp. 8-11; Bruinessen (1994a) "Genocide in Kurdistan? The Suppression of the Dersim Rebellion in Turkey (1937-38) and the Chemical War Against the Iraqi Kurds (1988)," in Andreopoulos, (ed.), *Conceptual and Historical Dimensions of Genocide*. University of Pennsylvania Press.

<sup>217</sup> Interview with Jabar Farman, Suleimaniyah, 18 June 1998.



#### 4.5.3.1 The Iran-Iraq War

At the commencement of the war, the PUK faced immense difficulties. With its support for the KDP-I, Iran's thrusts into Iraqi Kurdistan posed a threat to the PUK, pushing its headquarters away from the Iran-Iraq border area and closer to the forces of Iraq. The response of Talabani was to seek an accommodation with Saddam in 1984, allowing the PUK breathing space in which to reorganize. It also made it possible for the PUK to receive Iraqi weaponry, and for the Autonomy Law of 1974 to be further developed.<sup>218</sup> During this initial period of cooperation, the military structure of the party expanded, heralding the appearance of a new line of forceful and politically-minded cadres, including Mustafa Chaw Rash, Mam Risha, Mam Rostam, Sheikh Ja'efar, Mulazim Omer, and Mulla Bakhtiyar. Later, new military leaders appeared, including Kosrat Rasoul.<sup>219</sup>

##### 4.5.3.1.1 *Unity and Division within the PUK*

Since the demise of *Bezutnawa*, the PUK was somewhat unbalanced and ran the risk of alienating the middle classes of Iraqi Kurdistan with the radical exuberance of *Komala*. Dr Kamal Khoshnaw noted that if the two surviving wings continued as separate organizations, there would have been problems. Similarly, the practicalities of operating totally separate organizations under an umbrella of the PUK was increasingly cumbersome. It was therefore decided that the constituent entities of the PUK be brought together.<sup>220</sup> However, internal divisions, particularly in *Komala*, had not disappeared and the tensions of the political environment in the early 1980s brought them to the fore.

The completion of these plans, culminating with the formation of the PUK as it is today, would not take place until the 1990s. However, the first important step was taken in 1983, with the unification of the remainder of *Bezutnawa* with *Heshtigishti*. The new entity, named *Shoresh Garan*, was led by Dr Fu'ad Massoum, one of Talabani's compatriots from *Heshtigishti*. After 1982, the PUK therefore consisted of two separate wings.<sup>221</sup> The relationship between these two groupings proved to be

---

<sup>218</sup> For further details of the implications of these negotiations, see McDowall (1996) *op. cit.*, pp. 348-349; Sheikmous (1999) *op. cit.*, p. 60.

<sup>219</sup> Interview with Massoud Abdel Khaliq, Erbil, 18 July 1998.

<sup>220</sup> Interview with Dr Kamal Khoshnaw, Suleimaniyah, 13 May 1998

<sup>221</sup> Interview with Mohammad Tawfiq, Kalarcholan, 7 August 1999.

extremely cordial, although *Shoresh Garan* was almost certainly targeted to secure the support of the urban intelligentsia, with *Komala* remaining the wing of the more youthful revolutionaries. Again, *Komala* was by far the largest organization of the newly re-constituted PUK, yet the leadership of the PUK was evenly divided between the two wings.<sup>222</sup>

While the PUK was consolidating its internal structure, the ongoing negotiations between the leadership of the PUK and the GOI created serious ideological tensions within the ranks of the party. The initial doubt about the policies taken by the leadership can originally be traced to the division which characterised *Komala* from the moment of its inception, that of the pro-Iraqi communists versus the pro-Kurdish revisionists. The legacy of this disagreement did not dissipate with Talabani's seemingly pro-Kurdish bias, particularly when the most dominant man within *Komala* at the end of the 1970s, Mulla Bakhtiyar, favoured the pro-Iraqi solution. Within this struggle, Talabani favoured the pro-Kurdish line, represented by Nawshirwan Mustafa.<sup>223</sup>

Alongside this problem of ideology ran a clash of personalities. Within *Komala*, there was indignation against Talabani and his rapidly-ascending protege Nawshirwan Mustafa and, at the Third Conference of *Komala* in 1984, a problem became apparent when certain members were not selected for leadership positions.<sup>224</sup> The main opposition to the leadership of Talabani and Nawshirwan Mustafa came from a group led by Salar Aziz and Imad Ahmed.<sup>225</sup> The accusations levelled at the leadership concerned:

1. The power being given to *Shoresh Garan*.
2. Beliefs that Talabani was increasingly dependent upon the leaders of important villages and tribes.

---

<sup>222</sup> Interviews with Arsalan Bayaez, Suleimaniyah, 24 May 1998; Mohammad Tawfiq, Kalarcholan, 7 August 1999.

<sup>223</sup> Interview with Massoud Abdel Khaliq, Erbil,

<sup>224</sup> Amin (1999) *op. cit.*

<sup>225</sup> Salar Aziz would later become the Governor of Suleimaniyah and then Minister of Agriculture within the Third Cabinet (Suleimaniyah) for a short period. Imad Ahmed would later rejoin the PUK and enter the Political Bureau, as well as being Minister of Health and Social Affairs and, later, Minister of Power and Industry in the Third Cabinet (Suleimaniyah).



3. Rumours that Nawshirwan Mustafa was not a communist and had forced *Komala* to do as he desired for the ultimate benefit of *Shoresh Garan*.
4. *Komala* had deviated from the line developed by the work of figures such as Martyr Aram, and had become a bastion of nationalism at the expense of free ideology and political thought within the PUK.<sup>226</sup>

As the relationship between the PUK and the Ba'ath Party deteriorated and attacks both on the PUK and the *Komala* increased, the pro-Iraqi faction seized the opportunity to destabilise the PUK and created a party named *Alay Shoresh*.<sup>227</sup> An extensive propaganda campaign was undertaken against the PUK and *Komala* leadership, and *Alay Shoresh* members proceeded to leak plans and decisions of the PUK.<sup>228</sup> The PUK subsequently arrested Mulla Bakhtiyar and his compatriots, but Imad Ahmed escaped and managed to lead *Alay Shoresh* from Iran where he merged with the Toilers' Party of Abdul Khaliq Zangana. In 1992, both Mulla Bakhtiyer and Imad Ahmed rejoined the PUK Leadership Office in the political polarization which occurred after the elections. However, a great deal of damage had been done by this grouping to the position of the PUK, and the faultlines it created in the 1980s are still apparent twenty years later.<sup>229</sup>

#### 4.5.3.1.2 *The Collapse of PUK-GOI Negotiations*

The negotiations of 1984 between the PUK and GOI collapsed in January 1985. The subsequent *Anfal* Campaign and the series of military defeats suffered by the KDP and PUK at the hands of the forces of the GOI forced both parties to withdraw to the mountainous border areas between Iran and Iraq. It was these defeats and the huge scale of the *Anfal* campaign which forced both parties into bilateral talks in the summer of 1987.<sup>230</sup> These talks resulted in the formation of the Iraqi Kurdistan Front (IKF) in 1988.

<sup>226</sup> Amin (1999) *op. cit.*

<sup>227</sup> *Alay Shoresh* translates as 'Revolution Flag'.

<sup>228</sup> Amin (1999) *op. cit.*

<sup>229</sup> Sources requested anonymity. Also see Amnesty International (1995) *op. cit.*, pp. 10-11.

<sup>230</sup> Sheikmous (1999) *op. cit.*, p. 60.

#### 4.5.4 The Formation of the Iraqi Kurdistan Front

The final structural detail to note concerning the development of the political system was the formation of the IKF in May 1988. The IKF was established in order to coordinate opposition activity against the GOI.<sup>231</sup> The front was an umbrella covering the KDP, PUK, KPDP, KSP, PASOK, ICP (*Azadi*), KTP, and the ADM. The invasion of Kuwait by the forces of the GOI on 2 August 1990 acted as a catalyst for the re-invigoration of the Kurdish national movement in Iraq. According to members of the IKF, a meeting was held in Kasmorash (Iran) after the invasion of Kuwait in 1990. All parties and representatives were present and 3 scenarios were discussed.<sup>232</sup>

First, the IKF considered the possibility of Saddam holding Kuwait and effectively becoming the dominant Middle East power. In this case, the IKF acknowledged that the forces of the GOI could not be matched, and therefore planned to increase the size and scope of their covert forces, combined with a propaganda campaign. Second, the IKF studied the possibility of the Allied Coalition attacking Iraq and evicting Saddam's regime from Baghdad. If this were to happen, the IKF decided to attempt to unite Iraqi Kurdistan and bolster the *peshmerga* with Kurds returning from the Popular Army (conscripts) and *Jash* units. Once in a position of strength, they would seek autonomy, hoping that a post-Saddam Hussein Government would be more democratically minded.

Finally, the IKF considered the possibility of the Allies destroying the forces of Saddam Hussein, promoting a popular uprising in Iraq. The IKF considered that this would be the most likely option and plans were laid to strengthen the *mafraza* structure of the *peshmerga*, to increase communications between groups, and to regularize activities between the parties of the IKF. Sheikmous also forwards that these groups made significant efforts in winning over Kurdish *jash* forces and convinced the demoralised Iraqi forces to surrender without fighting.<sup>233</sup>

---

<sup>231</sup> Amnesty International (1995) *op. cit.*, p. 9.

<sup>232</sup> Interview with Jabar Farman, Suleimaniyah, 18 June 1998. See Sheikmous (1999) *op. cit.*, p. 61.

<sup>233</sup> *Ibid.*



On the eve of the Second Gulf War, the IKF had established a structure aimed at coordinating their component activities and taking advantage of the geopolitical flux which was about to occur. However, even after the defeat of the forces of the GOI, it would be a popular uprising rather than the *peshmerga* forces of the IKF which would signal the birth of the *de facto* state.

#### 4.5.5 Conclusion

The characteristics of the current political system can be seen to have developed directly from events occurring since 1961. At this time, the KDP could not be described as a unified party representing a particular grouping. Instead, it was an uneasy alliance between the feudally-minded Barzanis, and the radical intellectuals characterised by the Ahmed-Talabani faction. Certain events can be identified as being influential in forming the contemporary political system. First, the division within the KDP in 1964, which resulted in the expulsion of members of the Ahmed-Talabani faction, would change particularly the orientation of the KDP in the future, and ensure that it would be continuously dominated by the Barzani family. The internecine fighting of 1966 enforced this division, but also identified the future importance of Talabani to the neighbouring states. The events of 1975, which saw the KDP of Barzani evacuating from Iraqi Kurdistan as a military force, witnessed the re-emergence of Talabani with the formation of the PUK. However, the involvement of foreign national powers in the massacre at Hakkari ensured that no alliance would ever exist between the feudal Kurds and the leftist politicians as represented by the PUK. Indeed, the impact of the Hakkari massacre on both the structure and morphology of the future PUK, and the relationship between the KDP and PUK, is still being felt today.

The development of the party political system in Iraqi Kurdistan is best described as being characterised by punctuated equilibrium, with the steady development of the system being changed drastically by extraordinary events. Furthermore, the system can be seen to be increasingly politically polarized, particularly after the formation of the *Komala* and the return of the KDP-PL. This polarization was also heightened by the actions of the KDP-PL and PUK against each other, and, with each party enjoying localised support, the division of the Iraqi Kurdish political system was

mirrored culturally, with the division between the rural and urban areas, and between the Bahdini and Sorani regions.

Indeed, this division between the two geographic regions of Iraqi Kurdistan was only one of several cleavages which existed within Kurdish society at the time. Social cleavages were particularly apparent, particularly between the traditionally-minded rural Kurds, and the increasingly educated urbanites of the major cities which were growing in size. Tribal cleavages, which were to weaken but not disappear, remained influential, with tribes such as the Baradosti and Surchi maintaining significant militia, which neither Barzani nor Talabani could afford to ignore. Cleavages even reigned within the structures of the parties, with the KDP being characterized by an inherent division between party and peshmerga cadres, a division which has remained to the present day. As seen, the PUK was itself divided according to a more support-base pattern, reflecting the divisions within Kurdish society. Linguistic cleavages were particularly evident, with the KDP becoming associated with Bahdini speakers, and the PUK with Soranis. Perhaps in terms of confessional differences, the cleavages were not so clear cut or important, but the association of Barzani with the Naqishbandi sufic order, and Talabani with the Qadiri order, could only add to the conflagration of political cleavages which were occurring. Therefore, it can be seen that the Iraqi Kurdish political system, and the origin and development of its major political parties, has been significantly, and damagingly, influenced by the multiple schisms which existed in Kurdish society, culture, and demographic characteristics, in addition to the conflicting political ideologies permeating the Middle East at the time.



## Chapter 5

### The Organizational Structures and Decision-Making Processes of the KDP and PUK

#### 5.1 Introduction

Since the conception of the KDP, political parties in Iraqi Kurdistan have been a powerful variable in the development of the region. This has been especially the case in the 1990s. In this decade, the KDP and PUK, along with other smaller parties, have managed to overcome the traditional tribal power bases once pre-eminent in the Kurdish region and present themselves as organizations capable of mobilizing widespread popular support, military personnel, foreign national support, and substantial financial resources. However, while much has been written on Kurdish political history and the characters of the principal leaders of the Kurdish national movement, the internal aspects of organizational structure, decision-making processes and the characters of the parties have rarely been analysed and assessed.

The majority of analyses of the Iraqi Kurdish political parties, unfortunately in academic as well as journalistic literature, suffer from reductionist tendencies, with the KDP being described as tribal and the PUK as socialist. In discussing these reductionist viewpoints, Morris identifies the problems such analyses present to the understanding of Iraqi Kurdish politics:

*“A view has emerged over the years that [the] KDP and the PUK . . . . represent the two opposite poles of the Kurdish movement – the former rural and tribal, the latter urban and intellectual. This is an unhelpful simplification. On the one hand, both movements can be regarded as modern, if sometimes imperfect, political movements. On the other, the leaderships of both can often be seen behaving in a quasi-tribal way and using quasi-tribal methods to support their own political cause.”<sup>1</sup>*

#### 5.1.1 Aims

The aim of this chapter is to correct these reductionist tendencies and provide a detailed analysis of the operating mechanisms of the KDP and PUK. They are

---

<sup>1</sup> Morris (1999) *op. cit.*, p. 47.

described and analysed in terms of their organizational structures and decision-making processes. The aims can be summarized as follows:

1. To analyse and assess the organizational structure of the KDP and PUK in order to provide a basis for the analysis of the decision-making process.
2. To assess the decision-making processes of the KDP and PUK.
3. To identify power groupings, and their impact upon the overall decision-making process.

Such a study has inherent problems. It is not an easy task to produce an insightful analysis into the internal dynamics of Middle Eastern political parties. This is especially the case when the parties in question possess protective traits which are remnants from being conceived in a hostile environment and maturing in the face of extreme coercion from other states. Iraqi Kurdish parties are therefore elusive targets for academic inquisition. However, after spending four separate substantial periods in the field, and having discussed the political parties with members and non-members alike, my position to produce an insightful analysis is unique.

### 5.1.2 Structure

I commence with a chronological analysis of the development of the political system through the 1990s, identifying key moments of political history. Then, I present a description and analysis of the morphology of the selected political parties, developing on the findings of the preceding chapter. Once a morphological structure has been developed from observation, interviews and party documents, the decision-making process and operating procedures of the parties will then be presented.

## 5.2 Chronological Analysis of the 1990s

The 1990s has been characterised as a decade of lost opportunities for the Kurds, with the leadership of the KDP and PUK often blamed for squandering the chances presented to them after the Second Gulf War.<sup>2</sup> However, the 1990s may be seen to be a decade of political development, with the political system finding some sort of equilibrium in the milieu of geopolitical forces affecting it. Concerning the development of the PUK, Talabani noted that “*every party is like a man, and has a*

---

<sup>2</sup> See Gunter (1999a) *op. cit.*, p. 134.



*childhood [and] adolescence. The PUK is now at the first level of being mature.”*<sup>3</sup> Talabani’s sentiments can be applied to the Iraqi Kurdish political system in general throughout the 1990s. The system, and its failings, is best understood as undergoing the final stages of a transformation from being dominated by the control of central government and the guerrilla activities of political parties, to *de facto* statehood, with Kurdish government being established.

The current level of development is represented as a divided political system. The KDP and PUK are effectively separated by their inability to cooperate and compromise on issues relating to the distribution of power and wealth among their respective political elite. The aim of this chronological analysis, therefore, is to provide a political-history context of the 1990s in which to place an analysis of the structural organization and decision-making process of the principal political parties, illustrating the current level of the transformation with the solidification of this divided political system.

### 5.2.1 The Second Gulf War and the *Rapareen*

The invasion of Kuwait by the forces of Saddam Hussein in August 1990, the international reaction and subsequent decision to apply sanctions to Iraq as a whole, and the ultimate use of force to compel an unconditional withdrawal came almost as a miraculous reprise for the embattled parties of the IKF. After the defeat of Iraq by the coalition forces, a popular uprising occurred on 4 March, commencing in Raniyah.<sup>4</sup> By 10 March, Dohuk, Erbil and Suleimaniyah had fallen to the insurgency, and on 13 March Zakho also fell. As these cities fell, the *peshmerga* of the IKF returned in increasing numbers to Iraqi Kurdistan from Iran (Kasmorash) and joined

---

<sup>3</sup> Interview with Jalal Talabani, Kalarcholan, 14 September 1999.

<sup>4</sup> Sources in Kurdistan indicate that the *rapareen* (uprising) may have initially started in Erbil. After the *Anfal* campaign, the PUK and KDP returned covert groups of *peshmerga* back into the urban areas of Iraqi Kurdistan. These cells were active in promoting party ideologies, and in attempting to undermine the authority of the GOI. The presence of these units may have been a catalyst for the *rapareen*, however, independent sources within the region who have chosen to remain anonymous state that the *rapareen* of Erbil commenced after a popular demonstration took place on 10 March, led by members of the Kurdistan Communist Party. Interviews with Jabar Farman, Suleimaniyah, 18 June 1998; Shwan Qliasani, Suleimaniyah, 4 August 1999.

the insurgency. The forces of the IKF continued to advance and took Kalar, Kifri, Tuz Khurmatu, Chamchamal, and part of Kirkuk.<sup>5</sup> On 19 March, Kirkuk itself fell.<sup>6</sup>

The triumph was shortlived. With the uprising in the south of the country under control, Saddam moved the Republican Guard, heavy weapons and tanks north. The expected support from the US led coalition did not appear for the Kurds, and, on 28 March, Kurdish forces were forced out of Kirkuk, and then Erbil, Dohuk and Zakho.<sup>7</sup> The result of the return of the Republican Guard to Iraqi Kurdistan was the exodus of approximately 2.5 million people to the mountains bordering Iran and Turkey.<sup>8</sup>

On 5 April, the UN Security Council passed Resolution 688. It was an historic resolution as it was the first to ever mention the Kurds by name. It was also the first resolution in which the UN had insisted on the right of interference in the internal affairs of a member state by demanding an end to the repression of citizens of Iraq, particularly in the Kurdish regions.

But, on the ground, the danger had not diminished. By the end of April, 250,000 Kurds had reached the Turkish border with an equal number still on the way, and the majority were hopelessly equipped for winter in the mountains. In mid-April, the allied forces announced the establishment of a 'safe haven' inside Iraq, prohibiting Iraqi planes to fly north of the 36 parallel. The first Kurds moved into this haven on 28 April. This coincided with the massive relief operation mounted by NGOs that had begun unilaterally and then continued under the terms of an MOU signed by the UN and the GOI on 18 April 1998.

---

<sup>5</sup> The IKF offered a general amnesty to *jash* units. The KDP state that this was an initiative of Massoud, and helped to relieve the tension apparent within the political system at the time. However, the IMK refused to accept this and still refuse to operate with ex-*jash* personnel. Interviews with Ibrahim Tahir, Halabja, 19 June 1998; Hoshyar Zebari, Salahadin, 29 May 2000.

<sup>6</sup> Voice of the People of Kurdistan, Suleimaniyah, 7 March 1991 (SWB ME/1016), 8 March 1991 (SWB ME/1017); Interview with Jabar Farman, Suleimaniyah, 18 June 1998.

<sup>7</sup> The swift return of the forces of the GOI to the liberated areas is an indicator of the lack of fully mobilized *peshmerga* presence in the region. Indeed, anonymous sources indicated with some disdain that, initially, the *peshmerga* were welcomed into the areas liberated in the *rapareen*, expecting them to solidify the gains made. However, it is claimed that the *peshmerga* were tasked with ensuring the distribution of fuel amongst the vehicles of the parties of the IKF, leading some to say that they were more interested in guarding the fuel, rather than guarding Kurdistan.

<sup>8</sup> Sheikmous (1999) *op. cit.*, p. 62. Also see Abd al-Jabbar (1992) "Why the Uprisings Failed." *Middle East Report*, (May-June, 1992): pp. 2-14.



However welcome this initiative was in easing humanitarian hardships, it was little more than a stop-gap and certainly not an attempt at producing a political solution. The leadership of the IKF had little alternative but to negotiate with Saddam. Confederation was discussed between the two as both sides wanted to dig themselves out of an increasingly intractable position. By mid-June it was obvious that negotiations were drawing to a halt. Talks were inconclusive and in the summer of 1991, they consequently failed.<sup>9</sup>

In Kurdistan, disagreement was becoming apparent in the leadership. Talabani became more belligerent whereas Massoud seemed to be conciliatory towards the GOI. Frustration set in on both sides and, although in nominal control, GOI forces found it impossible to deny a *peshmerga* presence in Erbil and Suleimaniyah. Serious fighting broke out in October as both sides tested their defences and the response of the Coalition, and Kurdish autonomy appeared increasingly less likely.<sup>10</sup> In October, Saddam's government withdrew from the north and imposed an economic and administrative blockade on Iraqi Kurdistan leaving a vacuum which paralyzed the civil administration and its services. The GOI forces withdrew behind a defensive line, cutting off salaries to Kurdish employees, and imposing a second blockade on the Kurdish region. In doing so, the civil operation of Kurdistan was paralyzed.

### 5.2.2 The De Facto State

The IKF formally withdrew from the autonomy negotiations and announced its intention to replace the Iraqi Legislative Assembly with a freely elected KNA.<sup>11</sup> Multi-party elections occurred on 19 May 1992, resulting in an almost equal division between the KDP and PUK. The KNA was therefore divided equally between the two parties, and a power-sharing arrangement was established which resulted in the executive organs of the government being dominated throughout by the KDP and PUK in a structure which exhibited stability for only as long as the two main parties refrained from fighting.<sup>12</sup>

---

<sup>9</sup> Agence France Presse, Paris, 9 September 1991 (SWB ME/1173); Graham-Brown (1999) *op. cit.*, p. 219.

<sup>10</sup> Graham-Brown (1999) *op. cit.*, p. 219.

<sup>11</sup> Gunter (1993) *op. cit.*, pp. 88-93.

<sup>12</sup> The development of the 50-50 system is highly complex and fully analysed in Chapter 7.

Barzani and Talabani remained outside the official organs of governance and administration, acting as political arbiters controlling the activities of the *de facto* state from their respective political bureau. The political problems which plagued the government, alongside deteriorating socio-economic conditions and the polarization of the political system caused by the coalescing of smaller parties, meant that the political atmosphere of Iraqi Kurdistan did not remain calm, and the *de facto* state, by 1993, was on the verge of being rent apart.

### 5.2.3 The Conflict of 1994

These factors resulted in the administration failing to make inroads in meeting the people's high expectations after the success of the election. Mounting security problems also limited the power of the administration at this time. The response of the KRG was to regulate tightly the resources it controlled, which were considerable, but this rigid attitude of governance again stifled initiatives and resulted in the paralysis of the administrative decision-making process. The decline into conflict seemed to be a rapid, and inevitable, process.

The internal fighting of 1994 was due to many problems, but all of them can be traced to the struggle for power by the KDP and PUK. The manipulation of the KRG by both factions in 1993, and the operation of an aggressive alignment policy by both sides resulted in a serious rise of tension from September 1993 onwards. A push for fresh elections in 1995 by the KDP in January 1994 appeared to be the key to the PUK deciding that it must take power by a *coup d'état* rather than by more constitutional means.<sup>13</sup>

#### 5.2.3.1 The Involvement of the IMK

Relations between the PUK and the KDP started to become dangerously strained from September 1993 after the rounds of amalgamations of political parties. The Kurdistan Socialist Party (KSP) faction of Hama Haji Mahmoud, which had ostensibly merged with the KDP, attacked the KDP in Suleimaniyah. This action, which should be seen as part of the polarization process was not significant in

---

<sup>13</sup> See Chapter 7 for a full analysis of the polarization of the political system.



military terms, but heightened the tensions in the changing political arena.<sup>14</sup> An attempt at reconciliation by both leaders resulted in detailed discussions on all policy matters taking place for a two-month period, culminating with the signing of a strategic agreement between Barzani and Talabani establishing a Presidential Council on 20 December 1993. However, on this day, fighting erupted between the PUK and the IMK, with the IMK attacking and gaining Raniya and Betwata.<sup>15</sup> At this time, Talabani was abroad leaving the control of the situation in the hands of the Political Bureau. The Political Bureau decided to send its *Peshmerga* Commander, Jabar Farman, to recapture Raniyah. In a campaign which was to add to the ruthless image of Jabar, PUK forces fought between 24 and 27 December, and defeated the IMK. Jabar captured the leader of the IMK, Sheikh Othman Abdul Aziz, and handed him over to the KDP which had threatened to attack if he was harmed.<sup>16</sup>

The affair was alarming on two counts. First, it illustrated the amount of covert political manoeuvring that was taking place by both sides, even when the leaders were in close consultation, and, second, it showed that the PUK was willing to use great force to achieve its aims. The relationship between the KDP and PUK after this event deteriorated into serious armed conflict in May 1994.

### 5.2.3.2 KDP – PUK Conflict

The tensions which existed between the KDP and PUK in 1994 meant that the Presidential Council collapsed and political control remained with Political Bureaus. The situation was extremely volatile and only required a spark to ignite a serious confrontation. This was provided when a land dispute in Qala Diza between members of the two parties escalated, seemingly without the input of the leaderships.<sup>17</sup> The

<sup>14</sup> Gunter (1999a) *op. cit.*, p. 75; Graham-Brown (1999) *op. cit.*, p. 226.

<sup>15</sup> At this time, Raniyah was the stronghold of the IMK. Jabar Farman blamed this outbreak of fighting on the manipulation of the IMK by the Iranian Government, which was concerned about the establishment of the KNA and wished to destabilize Iraqi Kurdistan. According to Jabar, the KDP had a military agreement in place with the IMK and pushed them to provoke the PUK. Dr Ibrahim Tahir, the current Commander of IMK *Peshmerga*, did not confirm this, but hinted towards it by stating that, in 1993, "*Kurdish parties forced the IMK to fight*". This is somewhat difficult to prove or disprove, but it does illustrate that, behind every political event in Iraqi Kurdistan, there is always a web of underlying motives and actions. Interviews with Dr Ibrahim Tahir, Halabja, 19 June 1998; Kamal Haji Ali, Halabja, 19 June 1998; Jabar Farman, Suleimaniyah, 30 August 1998.

<sup>16</sup> Interview with Jabar Farman, Suleimaniyah, 30 August 1998.

<sup>17</sup> Kurdistan Democratic Party (1994) *What Happened in Iraqi Kurdistan, May-1994?* Salahadin, Erbil: KDP Research Department, p. 9; Graham-Brown (1999) *op. cit.*, p. 226; Gunter (1999a) *op. cit.*, p. 76.

PUK took the KNA and KRG institutions and pressed for military gains on the ground, particularly in Suleimaniyah Governorate. The KDP similarly mobilized and disorganised battles took place intermittently in Rowanduz, Shaqlawa, and Qala Diza until the end of August. While this fighting was ongoing, the IMK seized the towns of Halabja, Penjwin and Khormal from the PUK and, in doing so, received considerable support from the KDP.

Meetings were held between the leaderships of the PUK and KDP throughout June resulting in the signing of the Paris Agreement in July, which was ratified by an alliance pact of the two political bureaus.<sup>18</sup> However, fighting again erupted in December leaving thousands of displaced civilians, the city of Erbil in the hands of the PUK, and the administration effectively divided.<sup>19</sup>

1995 began with the struggle between the two parties unresolved, and with Iraqi Kurdistan partitioned into two main areas, and a smaller area for the IMK. With an election due in 1995 the tension again increased. The PUK was left in control of Suleimaniyah and Darbandikhan Governorates, and a substantial part of Erbil Governorate, including the city of Erbil itself. The KDP held Dohuk Governorate and the areas of Erbil Governorate north of Salahadin.<sup>20</sup>

#### 5.2.4 The Invasion of Erbil, 1996

The situation between the KDP and PUK remained tense throughout 1995 and by June 1996 there were reports of renewed confrontations, including the killing of Agha Surchi, the leader of the Kurdistan Conservative Party by the KDP during a disagreement over the allegiance of the powerful Surchi tribe.<sup>21</sup> The PUK accused Massoud of re-opening relations with Baghdad, and the KDP alleged that the PUK had assisted Iranian forces in their attack of a KDP-I camp in Koysinjaq in late July,

---

<sup>18</sup> Graham-Brown (1999) *op. cit.*, p. 226.

<sup>19</sup> Massoud and Talabani met in Erbil on 5 June and in Silopi (Turkey) on 13 June. Kurdistan Democratic Party (1994) *op. cit.*, p. 9. The KDP consistently contend that the plan had been pre-arranged by Talabani and the PUK, which explains his absence throughout the duration of the fighting, allowing the PUK *peshmerga* to make substantial military gains before he appeared to be in a position to call a cease-fire. The figure of Jabar Farman was heavily implicated in the escalation of the fighting.

<sup>20</sup> Graham-Brown (1999) *op. cit.*, p. 227.

<sup>21</sup> *Ibid*, p. 232; Gunter (1999b) *op. cit.*, p. 75.



where they also left a significant amount of arms for the PUK.<sup>22</sup> After Massoud failed to win support from the US in countering the perceived Iranian threat, he turned to the GOI for assistance. Ever cautious, Massoud defended his actions in language couched in terms of protecting Iraqi territorial integrity: “*After the United States and the West refused to listen to us, we agreed with the central government to end this foreign threat.*”<sup>23</sup> Later, in a similar vein, Sami Abdul Rahman of the KDP Political Bureau stated, with reference to the invasion of Erbil, that “[we] *would take any steps deemed necessary to protect the interests of the Kurdish people.*”<sup>24</sup>

On 31 August 1996, the KDP attacked Erbil City with the support of the GOI. The PUK was forced out of the city and the KDP then pressed home their advantage and took Suleimaniyah. However, the PUK received Iranian support and the subsequent counter-attack pushed the KDP out of Suleimaniyah and back into Erbil Governorate. Massoud disparagingly noted that “*Suleimaniyah was taken with the help of Iranian guards, Iranian weapons, and Iranian bombs.*”<sup>25</sup> The resulting cease-fire line developed from the subsequent stand-off between the two parties.

#### 5.2.4.1 Operation Vengeance Storm, 1997

Throughout the remainder of 1996 and the beginning of 1997, US and western powers were actively involved in attempting to solidify the cease-fire between the two parties. The Ankara peace process, initiated by the US, UK and Turkey, attempted to consolidate the tenuous cease-fire and promote the re-unification of the administration through four main initiatives:

1. The formation of an interim coalition government in Erbil;
2. Normalization of the city of Erbil;
3. Transferring of all Iraqi Kurdistan’s border revenues to a central bank, and;

---

<sup>22</sup> Middle East News Agency, Cairo, 15 July 1995 (SWB ME/2357); Iraqi News Agency, Baghdad, 15 July 1995 (SWB ME/2357); Voice of the People of Kurdistan, Suleimaniyah, 31 December 1995 (SWB ME/2499), 29 January 1996 (SWB ME/2523); Al-Hayat, London, 7 March 1996 (SWB ME/2556); Arm the Spirit Information Service, 30 July 1996 (SWB ME/2681); Voice of Iraqi Kurdistan, 17 August 1996 (SWB ME/2694), 22 August 1996 (SWB ME/2699); Voice of the People of Kurdistan, Suleimaniyah, 22 August 1996 (SWB ME/2699); Gunter (1999b) *op. cit.*, p. 75; Graham-Brown (1999) *op. cit.*, p. 232.

<sup>23</sup> Voice of Kurdistan, 23 September 1996, quoted in Gunter (1999a) *op. cit.*, p. 86.

<sup>24</sup> Interview with Sami Abdul Rahman, Salahadin, 27 June 1998.

<sup>25</sup> Quoted in Gunter (1999b) *op. cit.*, p. 76.

#### 4. Setting of a date for new regional elections.<sup>26</sup>

However, the Ankara initiative stumbled on the age-old issue of the revenue of Ibrahim Khalil. Tensions had also been seriously heightened by the alliance between the KDP and Turkish military which aimed to remove the PKK from Iraqi Kurdistan. The Turkish airforce reportedly attacked PUK positions as well as those of the PKK. The PUK and KDP met in London for the sixth round of talks in October 1997. However, when the KDP refused to agree to the immediate sharing of the revenue and the establishment of a coalition government, the PUK launched a large-scale offensive on 13 October 1997, code-named Operation Vengeance Storm.<sup>27</sup> The PUK made significant gains and deployed a large arsenal of heavy weapons including Soviet-made GRAD surface to surface missiles. However, the Turkish military assisted the KDP by deploying its airforce against the advancing PUK and, by the middle of November 1997, the KDP had regained the lost ground and the dividing line between the two reverted to the Degala-Koysinjq position.<sup>28</sup>

#### 5.2.4.2 Conclusion

The geographical result of the 1996 round of fighting was the KDP being located in the governorates of Erbil and Dohuk, and the PUK being in Suleimaniyah Governorate and parts of Erbil and Kirkuk Governorates. The cease-fire line was re-established between Degala and Koysinjq, and remains in 2000 (see Figure 3.3). The KDP's position appeared to be totally dominant, with full control of Ibrahim Khalil, Dohuk and Erbil cities. Talabani's position was more precarious. Farther away than ever from securing revenue needed for the party and, now, administration, the PUK had also been expelled from the natural seat of government in Erbil, and now had all of its high politicians in one small city. Perhaps more importantly, Talabani was now more reliant than ever on the support of surrounding countries. However, in terms of popular support, the KDP suffered. Many Kurds could not believe that Massoud had acted in collaboration with the GOI. Furthermore, the city of Erbil did not fully welcome the KDP, particularly with its GOI allies just south of its environs. Therefore, although not financially or geographically well placed,

<sup>26</sup> Gunter (1999a) *op. cit.*, p. 87.

<sup>27</sup> Radio Monte Carlo, Paris, 13 October 1997 (SWB ME/3050); Voice of the People of Kurdistan, Suleimaniyah, 13 October 1997 (SWB ME/3050); Gunter (1999a) *op. cit.*, pp. 88-89.

<sup>28</sup> Interview with Shwan Qliasani, Suleimaniyah, 4 August 1999; Gunter (1999a) *op. cit.*, pp. 89-90.



Talabani and the PUK did enjoy some form of resurgence of popular support in Erbil and Suleimaniyah.

Expulsions of opposing party members from Erbil and Suleimaniyah took place resulting in a large increase in the number of Internally Displaced Peoples (IDPs), stringent check-points were established, and both sides consolidated their power. In practical terms, the political system was now characterised by the division of the territory between the two most powerful parties, and each would now go ahead and establish its own regional administration. Perhaps surprisingly, this system has proved to be remarkably stable and has allowed, in the political party sphere, for the KDP and PUK to not be overly concerned with securing their power base vis-à-vis the other side. The reasonably stable environment has created a situation of political elite accommodation in which many internal party stresses have been addressed, and which has allowed the administration of the region to progress in a more technocratic, peaceful manner, rather than be coloured by partisan considerations.

### 5.2.5 The Washington Agreement of 1998

#### 5.2.5.1 The Shaqlawa-Koysinjaq Meetings

To their credit, the KDP and PUK established an indigenous peace process in the winter of 1997. After an exchange of letters took place between Talabani and Massoud in December of 1997, delegations from the two parties met, initially under the auspices of the Ankara peace process, but being characterised as wholly Kurdish, and chaired by the respected ex-KSP leader Aziz Mohammad. The first meeting took place on 12 February 1998 in Shaqlawa (territory controlled by the KDP). The KDP delegation was led by Sami Abdul Rahman, and also included Jawher Namiq Salim (Speaker of the KNA), and Bruska Nuri Shawaise (member of KDP Central Committee). The PUK delegation was led by Dr Kamal Fu'ad (PUK Political Bureau), and included Omer Sa'id Ali (Political Bureau) and Arsalan Bayaez (Political Bureau). This meeting formulated confidence building measures including the enforcing of the cease-fire, the ending of media attacks, the release of prisoners, the ending of expulsions, the establishment of a joint committee to ensure the implementation of SCR 986, and the promotion of increased coordination of public service ministries.

The meetings continued at approximately fortnightly intervals, and roughly alternated location between Shaqlawa and Koysinjaq in PUK territory, or occasionally at Degala. These meetings should be seen as important as they proved that the KDP and PUK could sit down at the same table and discuss technical issues separately from political issues. The specialised sub-committees formed to coordinate the public service sectors proved to be reasonably successful, and resulted in the reduction of check points between cities, and the easing of travel restrictions between Erbil and Suleimaniyah.

#### 5.2.5.2 The Washington Agreement

Following the renewal of the US political initiative in Iraqi Kurdistan, David Welsh, the Principal Deputy Assistant Secretary of State for Near Eastern Affairs, visited Iraqi Kurdistan on 17 July 1998 and met with both Massoud and Talabani, inviting both leaders to Washington DC for talks. The visit to Washington culminated with the Washington Agreement of 17 September 1998.<sup>29</sup>

The Washington Agreement built on the previous Shaqlawa–Koysinjaq meetings. In effect, it mirrors the advances made by those meetings, but, with the sponsorship of the US, gave the Kurds increased security against the potentially destructive policies of the Governments of Turkey and Iraq. The agreement was expected to draw the two political parties into closer cooperation and, hopefully, result in the formation of an interim administration, in Erbil, followed by multi-party elections to unify the KNA and the KRG.

However, its implementation has been characterised by limited cooperation on issues previously agreed at the Shaqlawa meetings. Issues such as the normalisation of travel between Suleimaniyah and Erbil, the supplementing of civil service positions from KDP revenues, and, until recently, the preservation of a ban on the use of media organs for propaganda purposes against the other side have been actively addressed with varying degrees of success.

---

<sup>29</sup> For a full analysis of the implementation of the Washington Agreement, see Stansfield (2000a) *op. cit.*, pp. 14-16. Also see Gunter (1999a) *op. cit.*, p. 100. For the full text of the Washington Agreement, see Appendix 2.



The implementation of some of the greater initiatives, such as the unification of the KRG and KNA, has proved to be problematic and subsequent disagreements have resulted in a significant increase of tension between the KDP and PUK, characterised by the resumption of media attacks and aggressive political maneuvering. The main problem with the implementation of the Washington Agreement is one of interpreting the key provisions, particularly with regard to:

1. The normalisation of the situation of Erbil, Suleimaniyah and Dohuk, with both parties able to operate in all cities;
2. Revenue-sharing, particularly with regard to the crossing-point of Ibrahim Khalil;
3. The establishment of a temporary unified government;
4. The re-unification of the KNA;
5. Security issues, especially with regard to the PKK;
6. The return of IDPs, and;
7. The timing of multi-party elections.

The PUK stated that the promotion of peace in Iraqi Kurdistan requires the following to be undertaken under the auspices of the Washington Agreement:<sup>30</sup>

1. A normalization of the situation in the capital, Erbil, then in Suleimaniyah and Dohuk.
2. A fair distribution of revenues.
3. The formation of a temporary government and the transferring of legislative authority to it.
4. After forming the government, ensuring the security on the borders with Iran and Turkey, and form a policy regarding the position of the PKK in Iraqi Kurdistan.
5. Return of the IDP's to their places of origin, with both the KDP and PUK releasing all prisoners.
6. Set a date for the next democratic elections, to be held no later than 3 months after the normalization of the situation of Erbil.

---

<sup>30</sup> The PUK was actively promoting these points in their two media outlets, *Kurdistanê Nwe* (in Kurdish), and *Al-Ittihad* (in Arabic). The above list is taken from *Al-Ittihad* and discussions with Jalal Talabani, Kalarcholan, 14 September 1999.

The interpretation of the Washington Agreement by the KDP proved to be somewhat different to that of the PUK. The following were their main areas of concern:<sup>31</sup>

1. The normalization of the situation in Erbil, Suleimaniyah, and Dohuk, and all other cities and towns at the same time.
2. The sharing of revenues between the KDP-controlled area and the PUK-controlled area should be dependent upon the current differences in revenue, and that such funding should only fund the public service ministries.
3. The necessity of forming a government and parliament according to the results of the election of 1992 (officially, the result suggested that the parliamentary division should be 51-49 in favour of the KDP, although this is a point of disagreement between the two KDP and PUK).
4. The KDP would not allow any concessions or conditions regarding the PKK, and would not allow them to be based in Iraqi Kurdistan.
5. Financial and material compensation for IDPs.
6. Elections should take place only after the normalization of relations in the major cities.
7. Issues regarding the composition of security forces are optional and no decision should, as yet, be made.

Such disagreements posed considerable problems to the leaderships of both parties. The PUK chose to focus mainly on the reliability of the results of the elections of 1992 and the size and eventual destination of revenues from Ibrahim Khalil. The KDP chose to focus on the issues of normalization between the cities and the necessity of having a system of government based on the official results of the elections (51-49), rather than on the 50-50 system employed in the previous first and second cabinets of 1992 to 1994.<sup>32</sup>

---

<sup>31</sup> Interview with Sami Abdul Rahman, Salahadin, 9 September 1999.

<sup>32</sup> Interviews with Sa'adi Ahmed Pira, Suleimaniyah, 13 September 1999; Hoshyar Zebari, Salahadin, 29 May 2000.



### 5.2.6 Conclusion

By mid-2000, the problems of implementing the Washington Agreement remained. Due to the efforts of both the KDP and PUK, the cease-fire has remained intact, and media attacks have remained few and far between. However, the initiative to draw the two parties into a unified administrative and political structure has failed and, if anything, the political system has been characterised by further divergence. After a seemingly fruitful meeting occurred between Nechervan Barzani and Talabani with the PUK Political Bureau in attendance in Suleimaniyah on 22 October, at the end of the month, the PUK surprisingly divided the last officially unified organ of the administrative structure, the judiciary, by establishing a second Supreme Court in Suleimaniyah.<sup>33</sup> Furthermore, the PUK went further and elevated Talabani to the position of the Leader of the Iraqi Kurdistan Region.<sup>34</sup> The impact on the unity of Iraqi Kurdistan is evident in the subsequent press release of the KDP, given by Sami Abdul Rahman:

*“The PUK’s decision is regrettable since it comes right on the heel of several KDP positive initiatives aimed at enhancing the peace process, mentioning in particular the recent visit by a high level KDP delegation headed by Nechervan Barzani to Jalal Talabani . . . . In return, the KDP was expecting a positive response not to deepen the segregation by setting up an illegitimate Cassation Court and partitioning the Judiciary in Kurdistan, which is the only institution remain[ing] intact in the region.”<sup>35</sup>*

The further promotion of municipal elections in the governorates of Suleimaniyah and Darbandikhan by the PUK again promoted a feeling of permanency to the current segregation. The elections, which occurred on 3 February 2000, were to select municipal councillors and the PUK won virtually all of the available seats. The KDP was again angered by the procedure, but intends to follow suit with similar elections in the near future. However, the KDP has not been innocent in the promotion of the segregation either. The provision of a regular tranche of revenue to

---

<sup>33</sup> See KDP press release of 25 October 1999, *Final Statement on the Joint Meeting Between the KDP and PUK*. The KDP delegation was headed by Nechervan Barzani and included Sami Abdul Rahman, Jawher Namiq, Dr Roj Nuri Shawaise, Azad Berwari, Zaim Ali, Falakadeen Kakayi, Sarbaz Harwami and Dr Abdullah Agreeen. The PUK delegation was composed of all members of the Political Bureau. The talks can be seen as an extension of the Shaqlawa-Koysanjaq meetings, with agreement being reached on prisoner exchanges, IDP repatriation, 986 implementation, freedom of movement, and revenue issues. Most importantly, the possibility of the KDP opening offices in Kalar and Suleimaniyah, and the PUK opening offices in Erbil and Dohuk was discussed.

<sup>34</sup> The story was first published in the PUK newspaper *Kurdistani Nwe*, 30 October 1999, no. 1987.

the KRG (Suleimaniyah) has not been upheld beyond the payment of one tranche of 50 million OID in 1999. Furthermore the establishment of the Fourth Cabinet in Erbil somewhat solidified the independence of the Erbil administration from that of Suleimaniyah, particularly as a political divide between constituent parties is still very much evident.

Two years after the Washington Agreement was signed, a range of options are available, and the US may be seen to be accepting the fact that it is somewhat difficult to unify immediately Iraqi Kurdistan.<sup>36</sup> Two obvious options would be to either promote a traditional-type of consociational system, with both the KDP and PUK joining in a power-sharing government in Erbil, or to continue on the current path of almost separate development in each of the administrative/factional areas. However, neither of these options is particularly attractive as the first course of action has already resulted in serious interfactional fighting, with neither party proving to be able to handle the political pressures created within such a system. The second option is again unattractive due to the serious inefficiencies which characterise the system, and the increasing disparity in wealth which is apparent between the Erbil and Suleimaniyah administrations.

An interpretation of the agreement includes possible areas of coordination in public service ministries, followed by a joint national assembly, and then possibly succeeded by a unified regional executive.<sup>37</sup> Such initiatives could be achieved with the adoption of a geographic-variant of a consociational political system, allowing the continued existence of two separate administrative structures, but with increased and enhanced coordination between the two, benefiting from progressive confidence-building measures at the political level, as envisaged by the Washington Agreement. The wisdom of bringing these two groupings back into one small city too quickly has to be questioned, particularly when this seemingly natural tendency of separation is being promulgated by the actions of the two parties, and indigenous peace processes are operating successfully due to the preservation of geographical areas of influence and security.

---

<sup>35</sup> KDP Europe, London, 2 December 1999.

<sup>36</sup> Interview with Hoshyar Zebari, Salahadin, 29 May 2000.

<sup>37</sup> *Ibid.*



## **5.3 The KDP and PUK**

### **5.3.1 Introduction**

As noted throughout the previous chapters, the political system of Iraqi Kurdistan is complex and has been characterised by tumultuous developments and events. The influence of particular leaders of the Kurdish national movement has been evident, and particularly the role of the Barzanis, Ibrahim Ahmed and Jalal Talabani. Further influential dynamics have also been identified, both in terms of political movements other than the KDP and PUK, and characters other than Massoud and Talabani. Whilst the preceding chapters have gone into considerable detail about the development of the political system and the characteristics of the movements concerned, it is necessary to develop an understanding of the internal structures and decision-making dynamics of the KDP and PUK.

#### **5.3.1.1 Structure**

In order to analyse the KDP and PUK in terms of internal characteristics/constraints and the relation between the parties and their external environment, the analysis commences with an assessment of their internal morphological structures. This is followed by an appraisal of the main channels of representation, as identified by the distribution of power within the party decision-making system. This corresponds to the first and second stage modelling process extemporised in the theory and methodology chapter.

An analysis and assessment is then presented which incorporates the findings of the fieldwork period and analyses the internal power structure of the party concerned, the influence of different power-groupings within each party, and the decision-making process within the party at a range of levels. The analysis of power groupings within the leadership structure illustrates that the parties are characterised by centralised leadership structures governing a politics of diffusion ensuring that pluralistic concerns are balanced within a hegemonic structure.<sup>38</sup> Finally, the chapter is concluded by identifying the main issues of the peace process which is ongoing between the KDP and PUK.

### 5.3.2 The KDP

The design of the KDP has at its foundation the influence of political parties from the moment of its inception, the influence of some influential Kurdish tribes and, subsequently, the influence of leftist thinkers such as Ibrahim Ahmed and Jalal Talabani. Many of the key political characters of the contemporary political system of Iraqi Kurdistan have been members of the KDP, and, therefore, the influence of the KDP on the physical design of other political parties is considerable. The analysis of the morphological structure of the KDP is undertaken in three stages: first, the leadership structure is developed; second, the main popular offices are identified, and; third, the recruitment and grass-roots offices are described. For the purposes of clarity, the structure described is that which was formulated by the Eleventh Congress of the KDP, held in 1993. Subsequent changes, particularly of personnel, are identified and analysed in later sections. However, the structure of the KDP did not change significantly between the eleventh and twelfth congresses.

#### 5.3.2.1 KDP Morphology

##### 5.3.2.1.1 *KDP Leadership Morphology*

Figure 5.1 displays the morphology of the leadership structure of the KDP. The leadership is constituted of three separate layers, each overlapping to a certain degree. The largest body, and supposedly the most influential, is the Central Committee (*maktabi nawandi*). The prescribed composition of the Central Committee is 37 *andams* (members) and 9 reserve personnel, chosen by secret ballot of the party Congress.<sup>39</sup> The committee is scheduled to meet once every month.<sup>40</sup>

The activities of the Central Committee are extensive, ranging from representation, oversight of party activities, and organizing of the party's internal elections. The main roles of the Central Committee include the providing of personnel and organizing of the KDP regional branch structure and Central Offices, and the identification of the Political Bureau.<sup>41</sup> The regional branch organizations are headed

---

<sup>38</sup> For further analyses of such systems in the Middle East, see Frisch (1998) *Countdown to Statehood: Palestinian State Formation in the West Bank and Gaza*. NY: State University of New York Press.

<sup>39</sup> Kurdistan Democratic Party (1993b) *Internal Programme of the Eleventh Congress of the Kurdistan Democratic Party*. Erbil. Article 6, paragraphs 2 and 3.

<sup>40</sup> See Appendix 3 for the members of the Central Committee as appointed by the Eleventh and Twelfth Congresses.

<sup>41</sup> *Ibid*, article 7, paragraphs 1, 13; article 8, paragraph 2



by a member of the Central Committee. The Central Offices of the KDP represent the administrative and policy implementation organs of the party. It is the role of the Central Committee to organise and staff these offices. However, these offices are normally headed by a member of the Political Bureau.<sup>42</sup>

The Political Bureau (*maktab sayarsi*) is, officially, the pre-eminent decision-making body of most Iraqi Kurdish political parties, and the KDP is no exception. It may be referred to as being the executive committee of the party.<sup>43</sup> As has been seen in the previous chapters, the KDP Political Bureau has been heavily involved in the development and history of the Kurdish national movement. Its members possess perhaps the most power of any political institution within Iraqi Kurdistan, and, as individuals, possess considerable power and influence themselves.

From studying Figure 5.1, it is clear that the Political Bureau is part of the Central Committee, as well as being considered a higher office. It is elected from members of the Central Committee by secret ballot.<sup>44</sup> The Political Bureau numbers 9 persons, and within the bureau there exists a steering committee whose role it is to oversee the running of the office.<sup>45</sup> The position of head of this committee is important and may be seen to be the highest official position within the party, apart from the immediate circle of the President. Between 1996 and 1999, the head of the steering committee was Sami Abdul Rahman, with the other members being Azad Barwari and Arif Taifour. Since the Twelfth Congress of October 1999, the previous Speaker of the KNA, Jawher Namiq Salim, has been head of the committee.<sup>46</sup>

The leadership structure of the KDP is headed by Massoud Barzani as President. Massoud is also a member of the Political Bureau and Central Committee. In addition, the President also has a number of his own private offices which act over a range of functions. Perhaps most importantly for the President, he retains control of

---

<sup>42</sup> *Ibid*, article 8, paragraph 7.

<sup>43</sup> Interviews with Sami Abdul Rahman, Salahadin, 3 April 1998; Muhsin Dizayi, Salahadin, 30 May 2000.

<sup>44</sup> Kurdistan Democratic Party (1993b) *op. cit.*, article 7, paragraph 1; article 8, paragraph 2.

<sup>45</sup> Interviews with Sami Abdul Rahman, Salahadin, 3 April 1998; Nechervan Barzani, Saryrash, 21 May 1998. Kurdistan Democratic Party (1993b) *op. cit.*, article 8, paragraph 1.

<sup>46</sup> Interview with Muhsin Dizayi, Salahadin, 30 May 2000.

**Figure 5.1: The Leadership Structure of the Kurdistan Democratic Party<sup>47</sup>**

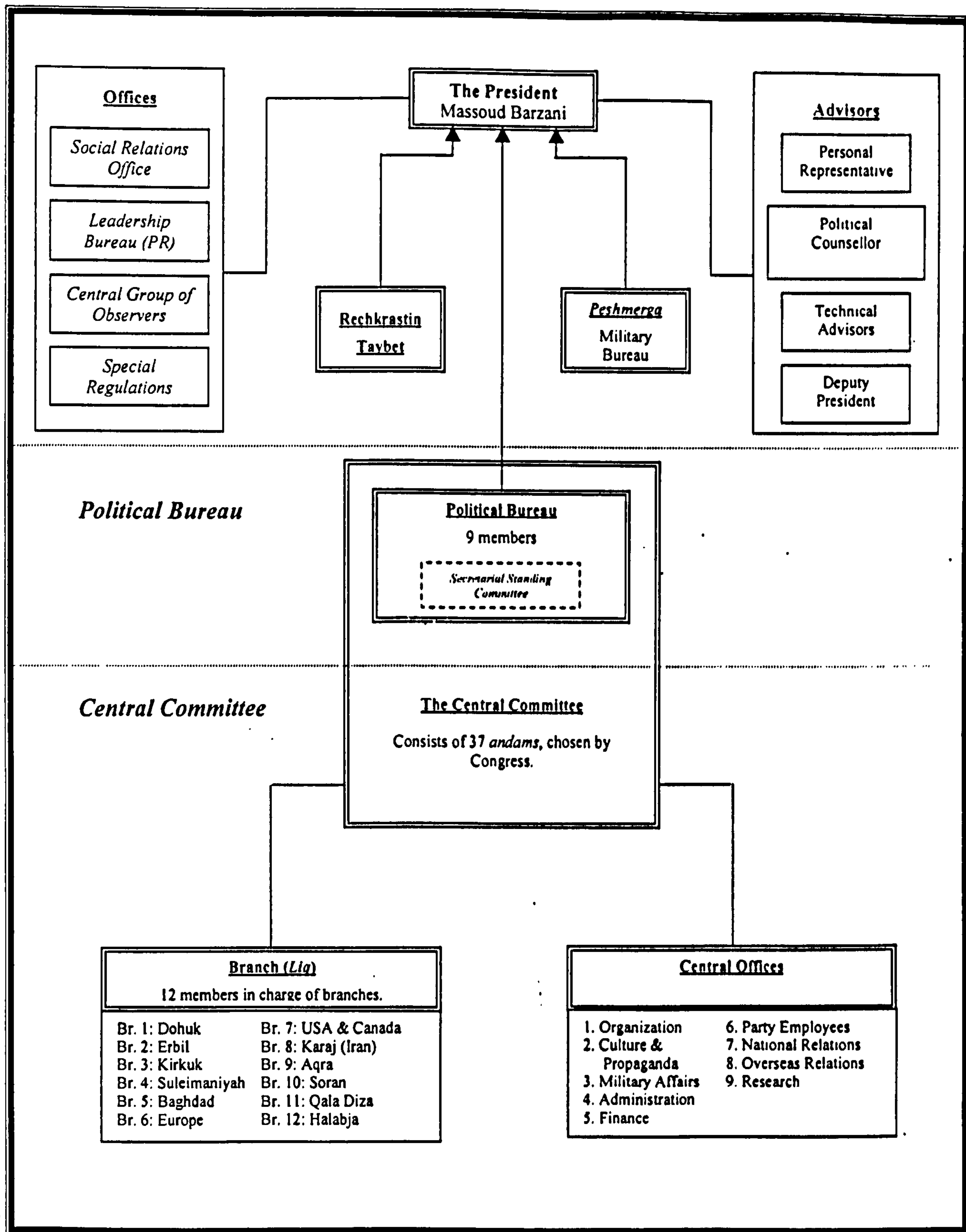

<sup>47</sup> Kurdistan Democratic Party (1993b) *op. cit.*; interview with Sami Abdul Rahman, Salahadin, 3 April 1998



both the intelligence service, the *Rechrastin Taybet (Parastin)*, and the military bureau.<sup>48</sup>

### 5.3.2.1.2 *Regional and Sub-Regional Structure*

As seen in Figure 5.1, the KDP geographic structure is headed by twelve regional branches (*liq*). Within each of these branches, the structure further subdivides into area offices (*nawcha*), then district organizational offices (*rechkrav*), community offices (*shana*) and, finally, recruitment cells. Figure 5.2 illustrates the morphology and relationship which exists between these organs. The *liq* may be seen to be the most public face of the party with regard to its interaction with the population of the region and represent, for the majority of the population, the highest office of the party dealing with immediate concerns and activities. The *liq* is the representative, and leader of, KDP activities in a large geographical area (defined by the Central Committee), and is appointed by and answerable to the Central Committee. Each *liq* is effectively a microcosm of the party itself, and contains representatives of each of the Central Offices, and a *Liq* Committee which manages the activities of the party within its region. The KDP, at this level, may be described as fractal, with the constitution of the lower offices being approximately the same as the higher ones.<sup>49</sup> The head of the *Liq* Committee has to be a member of the Central Committee, and it is the duty of the *Liq* Committee to forward reports on all party activities directly to the Political Bureau.

During the summer of 1998, I spent a considerable amount of time within the offices of *Leqi Du* (Branch 2, Erbil), discussing the operations of the office with its head, Sa'ad Abdullah. According to Sa'ad, the position of head of *liq* within the KDP is not considered to be permanent, and personnel are often rotated. Similarly, the internal structure of the branches are not the same and depend upon population size of the region, and political activity. *Liq* also exist even for those places which do not allow a KDP presence, including Suleimaniyah and Baghdad, but are currently based in Erbil with an attendant skeleton staff. Within *Leqi Du*, there are 12 *nawcha*, making a branch committee of 17 persons. Not all branches are organized according to the

---

<sup>48</sup> It should be noted that Massoud has been in charge of the *Parastin* and then *Rechrastin Taybet* since its foundation in 1964. Because of this, his knowledge of the personnel and procedures is unparalleled, giving him a great deal of personal security within the party.

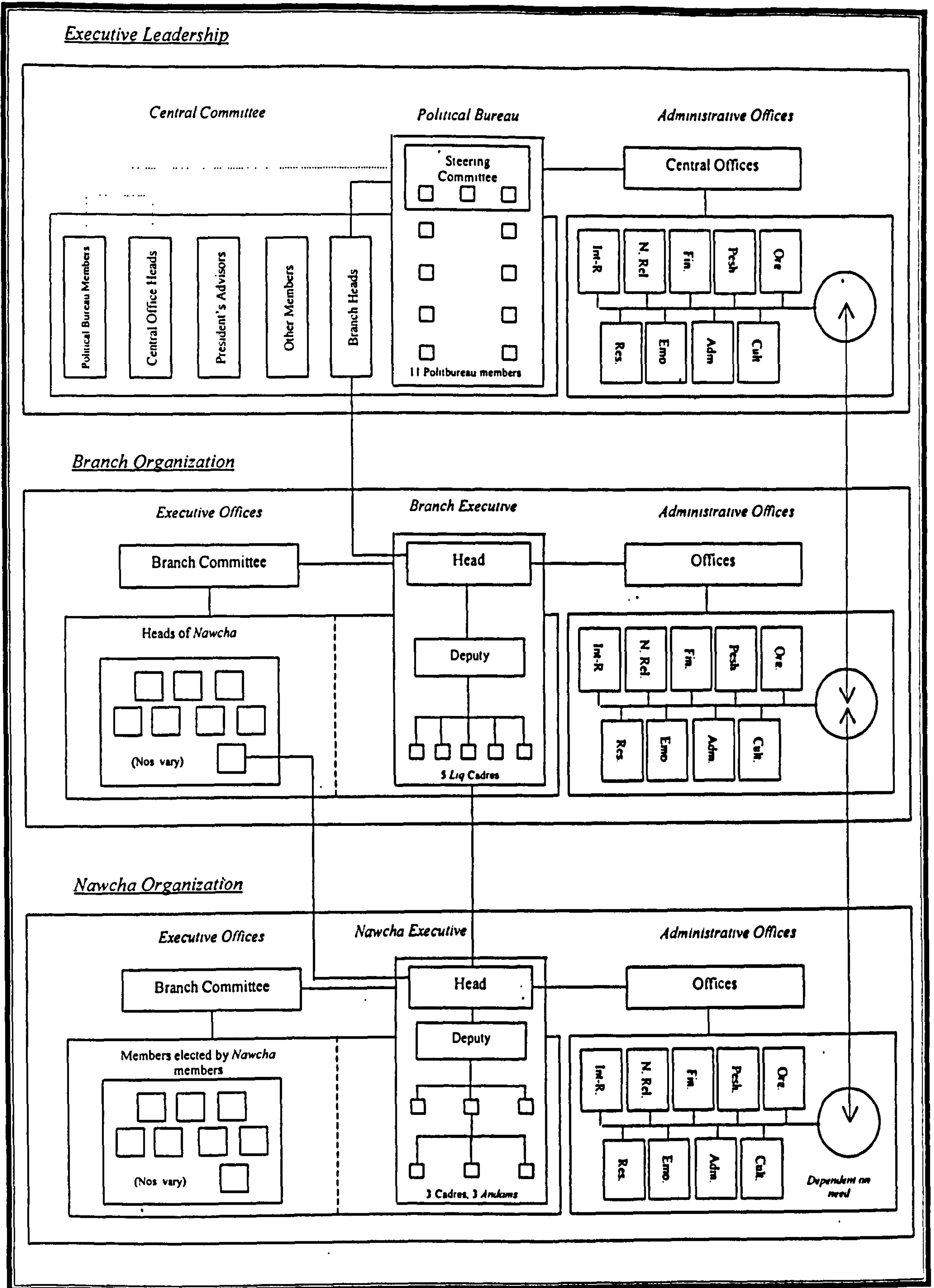

<sup>49</sup> Interview with Sami Abdul Rahman, Salahadin, 9 September 1999.



provisions of the party programme. In *Leqi Du*, for example, there are 17 members, but there be as many as 70 in other branches.<sup>50</sup>

The *nawcha* may be a geographic or trade union-based organization. For example, in the city of Erbil there are 2 geographic *nawcha* and 10 separate ones for different trades, including teachers, engineers, civil servants, and farmers. A similar system is also in operation for the organization of the *reckhraw*. The number of *reckhraw* per *nawcha* can vary between 7 and 20, and there are between 7 and 12 *shana* per *reckhraw*, with a *shana* numbering between 10-15 persons.<sup>51</sup>

Recruitment at the grass-roots level takes place at the level of the *shana*. The *shana* is a structure which developed during those times when the KDP had to operate covertly, and beneath the *shana* there are even smaller covert units. However, Sami stressed that, now that the KDP can be public, the operations of these units are less secretive and more open.<sup>52</sup>

#### 5.3.2.1.3 *Conclusion*

The above description depicts the outline of the KDP, and it is possible to apply this model to most political parties in Iraqi Kurdistan. However, whilst this description can go some way to in assisting with the understanding of the political system of the region, it misses many important aspects. For example, perhaps the most important aspect of the decision-making structure of the KDP is within the Barzani family itself. However, such structures would not appear in official documentation, or be a prescribed dynamic of the party. This factor is brought out in the later sections.

#### 5.3.2.2 *The Decision-Making Process of the KDP*

Critics of the KDP claim that the KDP decision-making process is dominated by the Barzanis, with the rest of the party being little more than the implementing agency of the family's wishes. In the following section, I examine the official decision-making process, as KDP documents and members describe it, before going on to address the views of KDP opponents. In the final section, I present an analysis of the internal

---

<sup>50</sup> Interview with Sa'ad Abdullah, Erbil, 9 September 1999.

<sup>51</sup> *Ibid.*

<sup>52</sup> Interview with Sami Abdul Rahman, Salahadin, 3 April 1998.

politics of the KDP in an attempt to fully assess and analyse its political decision-making process.

#### 5.3.2.2.1 *The Prescribed Decision-Making Process of the KDP*

Within the KDP, the highest recognised legislative authority is that of the Congress.<sup>53</sup> According to high-ranking members of the KDP, its decision-making process is fully democratic, with the direction of the party being decided by a Congress once every four years, with participants to the Congress being elected from the regional organizations at *nawcha* level. Congress then elects the Central Committee, Political Bureau and President. In identifying the position of the Congress in the KDP, Hoshyar Zebari noted to me that “*the KDP has been more democratic in the selection of its leadership than any other Kurdish party. Its leaders have always been elected, and never imposed.*”<sup>54</sup>

Just before the Twelfth Congress in 1999, I met with Massoud Barzani, who, in reference to the decision-making process of the party stated that;

*“It is worth noting that the KDP is the only party in Iraqi Kurdistan that has had a continuous programme of party congresses and conferences since its foundation in 1946. It is now nearing the Twelfth Congress. This shows one of the essences of the KDP when compared to other political parties. Congress is [its] highest authority.”*<sup>55</sup>

As well as electing personnel to the leadership offices, Congress also decides upon specific policies for political actions, and a plan of action for the development of the Iraqi Kurdistan region. The Central Committee is then responsible for implementing the decisions made by the Congress. To achieve this, the Central Committee elects from its members a Political Bureau. Between the two meetings of the Central Committee, the Political Bureau implements the decisions of the Central Committee. Furthermore, the *liq* organizations of the KDP are also elected, as are all the organs beneath it. Decisions made for the implementation of Central Committee directives are sent from the Political Bureau to the *liq*. For local issues, the *liq* may develop their own solutions, and every few months, the Central Committee evaluates

---

<sup>53</sup> Interviews with Sami Abdul Rahman, Salahadin, 9 September 1999; Hoshyar Zebari, Salahadin, 29 May 2000.

<sup>54</sup> Interview with Hoshyar Zebari, Salahadin, 29 May 2000.

<sup>55</sup> Interview with Massoud Barzani, Saryrash, 22 August 1999.



activities.<sup>56</sup> Such a system may seem to be idealised. However, Massoud is confident that such a process does take place, and that this democratic approach is insitutionalised within the KDP. He himself is particularly proud of this characteristic of the KDP, especially as he feels it is not too common in other political parties. With reference to this fact, he noted that “*the respect which KDP members have for each other and the procedures of the party is not found in the other political organizations.*”<sup>57</sup>

Before a Congress can take place, there has to be an extensive period of internal elections. The first stage of the KDP Congress election is held at the level of the *nawcha*. This stage elects the Congress delegates, and there is a constant ratio of 350 members per delegate. At the same time, the *liq* organizations form through this electoral process, with the *nawcha* committee being selected, followed by the formation of the *liq* committee. A special party committee coordinates all elections.<sup>58</sup>

#### 5.3.2.2.2 *Criticisms of the KDP Decision-Making Process*

Whilst this assessment depicts a structure which is undeniably democratic in plan, criticisms of the KDP abound, and particularly with regard to how power is exercised within the party. The prominence of Barzanis within the leadership has always been an immediate area of criticism which has been seized upon by all of the opponents of the KDP. When the leadership structure is analysed in detail, it is apparent that members of the Barzani family do indeed hold key positions within the party and government. Most notable of the family members is Nechervan, son of Idris and nephew of Massoud, who is in the steering committee of the Political Bureau, and is now Prime Minister of the KRG. Massoud has also strategically positioned his brothers around the world, with Farhad in Washington DC and Delshad in Berlin. Closer to home, Massoud’s youngest brother, Weji, is commander of the KDP special forces and his uncle, Hoshyar Zebari, is in charge of KDP foreign relations and representative to London. Furthermore, since the Twelfth Congress, Massoud’s son, Masrou, is now in the Political Bureau and Massoud’s brother, Sudat, has a position which may be likened to that of a whip of a UK political party.

---

<sup>56</sup> *Ibid.*

<sup>57</sup> *Ibid.*

It is therefore understandable why many analysts characterise the KDP as being dominated by the Barzanis. Members of the PUK describe the decision-making process of the KDP as being divided into three levels:<sup>59</sup>

1. Massoud, Nechervan, and some high level Barzani sheikhs.
2. Sami Abdul Rahman, Muhsin Dizayi, Falahkadin Kakai and advisors form an intellectual body, to present the decisions made by the Barzanis, with this group advising but having no power.
3. The Political Bureau and Central Committee approve and rubber stamp the policy.

However, should the supposed dominance of the Barzanis be a cause of concern, particularly in a democratic sense? Many legitimate regimes are dominated by families, is it fair to criticise this one for being so? The PUK certainly believe that the dominance of the Barzanis within the KDP is the main cause of corruption within the party.<sup>60</sup> However, Massoud has proven to be a leader willing to listen to the people around him and certainly values the expertise he has within the Political Bureau.<sup>61</sup> There is a consensus of opinion from KDP Political Bureau members that the majority of decisions are reached by democratic procedures, and on occasion go against the wishes of Massoud.<sup>62</sup>

Similarly, the Political Bureau under the leadership of Sami Abdul Rahman, and now Jawher Namiq Salim, is not without influence. The KDP is keen to point out that its Political Bureau possesses more intellectuals, graduates and doctorate holders than any other party's political bureau.<sup>63</sup> Furthermore, while the predominant position of

---

<sup>58</sup> Interviews with Sami Abdul Rahman, Salahadin, 9 September 1999; Sa'ad Abdullah, Erbil, 9 September 1999.

<sup>59</sup> Interview with Sa'adi Pira, Suleimaniyah, 9 June 1998.

<sup>60</sup> Interview with Hoshyar Zebari, Salahadin, 29 May 2000.

<sup>61</sup> The identification of Massoud as being a quiet, cautious, thoughtful man is common in the academic literature listed throughout this thesis, and has also been stated many times by others who have met him in a professional sense. I myself find Massoud to be the calmest of men. Such views are also shared by members of the Political Bureau who note that Massoud listens carefully to everything everybody says before speaking himself. Interviews with Phebe Marr, Durham, 9 July 1999; Massoud Barzani, Saryrash, 22 August 1999; Arif Taifour, Salahadin, 1 September 1999; Sami Abdul Rahman, Salahadin, 8 September 1999; Hoshyar Zebari, Salahadin, 29 May 2000.

<sup>62</sup> Interviews with Massoud Barzani, Saryrash, 22 August 1999; Arif Taifour, Salahadin, 1 September 1999; Sami Abdul Rahman, Salahadin, 8 September 1999; Hoshyar Zebari, Salahadin, 29 May 2000.

<sup>63</sup> Interviews with Arif Taifour, Salahadin, 1 September 1999; Sami Abdul Rahman, 8 September 1999; Hoshyar Zebari, Salahadin, 29 May 2000.



the Barzanis is obvious, the democratic procedures of the party are also readily apparent. While in Erbil, I followed closely the *nawcha* elections of the Second Branch of the KDP under the leadership of Sa'ad Abdullah. The elections were conducted with the utmost care, and the results of the elections (to the *nawcha* committees and to the Twelfth Congress) saw an increase in younger members at the expense of the old guard and, indeed, some Barzanis.

However, within the KDP, it is apparent that there is a horizontal division in existence within the decision-making process, with the leadership of the Barzanis not being too involved with the grass-roots activities of the parties, thereby allowing the promotion of democratic procedures at the level of the *nawcha* elections. At the level of the Political Bureau, the Barzanis exercise their power to the full. However, it is apparent the Massoud does not dictate to the KDP. Nechervan, in discussing the managerial skills of Massoud, stated that:

*“Massoud Barzani has many advisors and listens to many people while he is touring. He makes recommendations both to the Political Bureau and to the Administration. His style is to discuss and not to dictate.”*<sup>64</sup>

Massoud has always had a reputation of being quite, thoughtful, and keen to take the advice of those around him. This, at times, means that he appears more withdrawn than the effervescent Talabani, but Massoud does not suffer from the same accusations of being mercurial in argument and approach to leadership. However, perhaps more so than in any other political party in Iraqi Kurdistan, the KDP exhibits tendencies best described as 'democratic centralist'. A situation certainly exists within the KDP where discussion is evident, however, once a decision has been arrived at by the leadership, it is implemented without question by the lower echelons of the party.<sup>65</sup>

What is needed to assess fully and analyse the decision-making process of the KDP, and, indeed, any political party, is a set of events which illustrates the different dynamics which exist in the party at a particular moment in time. Fortunately, Such a window was provided in the late 1990s for the main political parties in the region.

---

<sup>64</sup> Interview with Nechervan Barzani, Saryrash, 21 May 1998.

With regard to the KDP, 1998 proved to be a remarkably successful year. The third cabinet became increasingly institutionalised within the region, relations with all neighbouring countries were reasonable, and the PUK was still suffering from the setbacks caused by their misguided attack of 1997. However, toward the end of 1998, and then through 1999, the KDP underwent some changes which exposed many of the complexities of the decision-making process, and illustrating that, rather than considering the KDP leadership dynamics to be a case of the Barzanis dominating over the party, we should be looking at what is happening amongst the Barzanis themselves.

### 5.3.2.3 Analysis and Assessment of the KDP Leadership Structure

In 1998, the KDP could be characterised as being a strong political party which was largely devoid of internal division, particularly when compared with the PUK. Benefiting from reasonably reliable revenues from the border crossing at Ibrahim Khalil, the political and administrative spheres increasingly diverged, with both less reliant on the other for securing or employing power. However, the negative side of this success occurred with the mismanagement of finances and political manoeuvring within the party leadership structure.

Throughout 1999 and 2000, the undeniable strength of the KDP in military, political and economic terms was readily apparent, however, it was also the case that this strength was fragile and Massoud, with one eye constantly on the opinion polls, realised that the party was ultimately reliant upon the electorate and being seen by it and the international community as a party of integrity.<sup>65</sup> Furthermore, and perhaps of more pressing concern for Massoud, the KDP was increasingly being affected by factionalisation around two wings – Massoud's own, and that of his nephew Nechervan. As the KDP has grown throughout the 1990s, so has the influence of different groupings within the power structure. The changes forced upon both the KDP and PUK by the changing external environment, for example, in becoming parties which have to administer rather than fight, has presented the leaders with the task of being seen to be maintaining democratic structures, yet not allowing for

---

<sup>65</sup> Interview with Hoshyar Zebari, Salahadin, 29 May 2000.

<sup>66</sup> Stansfield (2000a) *op. cit.*, pp. 14-16.



opponents to gain too much power. It is the management of this problem which has opened a window onto the power-structure of the KDP.

#### 5.3.2.3.1 Power Groupings

Throughout the late 1990s, the leadership of the KDP has been dominated by two Barzanis, not one. This structure, however, is an established feature of the KDP. The leader has always been supported by a member of the Political Bureau with almost equal power to the leader himself. During the mid 1970s, for example, Sami Abdul Rahman may be seen to be the support to Massoud. During the 1980s, Idris supported Massoud as President and, since the Tenth Congress in 1989, Nechervan is now the supporting Barzani.<sup>67</sup> However, Nechervan has been actively creating a support base within Dohuk Governorate and has accumulated a vast amount of wealth through various business dealings. The extent of his power is unrivalled within the KDP region, in both terms of political influence and financial control, and the management of this dynamic has been an issue which Massoud has been targeting particularly since 1998.

Within the KDP, there are therefore different power groupings. The first, and most powerful group, is that of Massoud. As party leader, his position is unassailable (particularly since the Twelfth Congress), as he has surrounded himself with family members and, lately, his son Masrour. With Massoud, it is always important to remember that he is half-Barzani, half-Zebari, and the younger of the two 'Barzani Brothers' who led the KDP in the late 1970s after the demise of Mulla Mustafa.<sup>68</sup> The death of his brother, Idris, resulted in Massoud becoming undisputed leader. However, feelings for Idris have remained strong in some sectors of more traditional Kurdish society and the KDP, and are now focused on the figure of Idris's son, Nechervan.

The second grouping is, therefore, led by Nechervan. As grandson of Mulla Mustafa and son of Idris, he has enjoyed a rapid rise up the hierarchy of the KDP and now

---

<sup>67</sup> Interview with Hoshyar Zebari, Salahadin, 29 May 2000.

<sup>68</sup> However, it should not be thought that Massoud is not the favoured successor of Mulla Mustafa. Of his three wives, Barzani's favourite was the second, Massoud's mother. It has often been stated in Iraqi Kurdistan that Massoud and Idris used to make a show out of having different mothers in an

occupies a position in the Steering Committee of the Political Bureau and is Prime Minister of the KRG. Nechervan has also developed a power base within the city of Dohuk and has links with many of the lucrative import-export businesses in the city, as well as administering the revenue earned at the border crossing point with Turkey at Ibrahim Khalil. Furthermore, Nechervan operates the Kurdish part of a GOI-Kurdish initiative shipping oil from Mosul to Turkey. The result of these operations is that Nechervan is a tremendously wealthy individual with a very strong power base within the KDP.

The third grouping is more of a collection of highly influential personnel under the leadership of Sami Abdul Rahman. As seen in previous chapters, Sami has not always been in the KDP, and in the 1980s led a vociferous opposition grouping which was highly critical of the tribally-orientated KDP, and particularly of Idris Barzani.<sup>69</sup> However, in the late 1990s, Sami was undoubtedly portraying himself as a true KDP man whatever his past may indicate, but remained highly influential amongst his previous party cadres within the KDP. Personnel of Sami's previous party (KPDP, and then UPK) now represent the intelligentsia of the KDP and the inclusion of the UPK can now be seen to have been a move which has broadened the support base of the KDP, and benefited the party with the inclusion of politicians of a very high calibre. However, whilst Sami's background and history which has often been in opposition to the Barzanis, Massoud is keen to keep him close to the decision-making process.

The interaction of these three groupings can be seen when the Twelfth Congress of the KDP is studied. The Congress, which occurred in October 1999, resulted in some major changes within the KDP. Perhaps most importantly, Massoud significantly strengthened his own position by bringing his son, Masrour, into the Political Bureau. Sami's appointment to the position of Deputy Prime Minister is also seen as a political move which originated with Massoud. Similarly, other members of the cabinet which Nechervan wanted removed have remained in key positions. However, the appointment to what may be considered a cabinet watch-dog position of Minister

---

attempt to encourage people into believing that there may have been a problem between them when, in reality, there was no issue present.

<sup>69</sup> See Chapter 4 for an assessment of the political career of Sami Abdul Rahman.



of the Cabinet of Shawkat Sheikh Yazdeen, a Nechervan supporter, may indicate that the Prime Minister still wields considerable power.

#### 5.3.2.3.2 *Conclusion*

The divisions within the KDP are still in an early stage and it is possible that nothing will come of these groupings. Massoud is undeniably in control of the situation and has gone a considerable way in promoting the KDP as a party of Kurdistan rather than of the Barzanis. It has been said that the KDP is a 'tribe behaving like a party', which is a reasonable assessment on one level.<sup>70</sup> The KDP displays strong internal cohesion of its party organs and, at least at the grass-roots level, has instituted a considerable degree of democratic procedures, particular with regard to the election of individuals to decision-making bodies. It should be noted that many members of the KDP do not consider it to be a party. Hoshyar Zebari stressed that the number of KDP members is actually quite limited, yet the KDP enjoys a great deal of support. He therefore characterised the KDP as a 'movement' which benefits from taking a middle, cautious, line in the resolution of the Kurdish problem in Iraq.<sup>71</sup>

Furthermore, it is interesting to note that the KDP adhere to the principals of electing personnel to the Central Committee and Political Bureau much more rigidly than does the PUK. For example, the KDP Political Bureau established by the Eleventh Congress in 1993 was unchanged throughout the next six years apart from the enforced changes caused by the death of an original member. The Twelfth Congress subsequently altered the composition of the office. This is quite different from what happens within the PUK, where appointments to the Political Bureau and Leadership Office are much more fluid and are by agreement between the different groupings which exist within the leadership itself.

#### 5.3.3 The PUK

Structurally, the PUK has a similar morphology to that of the KDP, which is perhaps not surprising when it is realised that their origins and development have been

---

<sup>70</sup> The identification of the KDP as a party of the tribes is somewhat flawed, as most of the powerful tribes of the region, including the Surchis and Baradostis, still dislike the KDP. Massoud noted to me that the KDP represents tribal peoples, intellectuals and technocrats alike, and has combined the forces of tribalism with those of Kurdish nationalism. Interview with Massoud Barzani, Saryrash, 22 August 1999.

inextricably linked. However, the manifestation of extreme-leftist political groupings has had a structural impact upon the PUK, and it is possible to trace many of the design features to *Komala*, one of the founding parties of the union. Notable differences include aspects of terminology, and in some more detailed areas regarding representation within the decision-making process. Perhaps the biggest structural difference can be seen to exist in the leadership apparatus, and particularly in the position of Talabani. The appraisal of the morphological structure of the PUK is identical to that of the KDP, enabling a close comparison to take place.

### 5.3.3.1 PUK Morphology

#### 5.3.3.1.1 PUK Leadership Morphology

Figure 5.3 displays the morphology of the leadership structure of the PUK. The similarities with the KDP are obvious, with both employing the same overlapping type structure. However, there are some apparent differences. The PUK equivalent to the Central Committee is the Leadership Office (*maktab sakredayeti*). The prescribed composition of the Leadership Office is 17 *andams* (members), however, in practice, the number is approximately 35, although this varies considerably depending upon who is in the region at any particular time.<sup>72</sup> The activities of the Leadership Office, as prescribed in the programme of the PUK, are virtually identical to those of the PUK, as are the roles of the subordinate offices of the structure. However, differences are apparent in the high-leadership structure, with Talabani being effectively the official head of all PUK Central Offices, with Deputies appointed to direct their daily operations. For example, the head of the Foreign Relations Bureau is Talabani, with Sa'adi Pira being his Deputy. A similar system is in force with the *peshmerga*, with Talabani being commander, and Jabar Farman running the organization as his second-in-command.<sup>73</sup> All offices are therefore answerable to Talabani, via the Political Bureau. Each of the Central Offices are also coordinated by a member of the Political Bureau, with these offices also having representatives in each geographical *melbend*.<sup>74</sup>

---

<sup>71</sup> Interview with Hoshyar Zebari, Salahadin, 29 May 2000.

<sup>72</sup> Patriotic Union of Kurdistan (1993) *Internal Programme and Method of the PUK*. Erbil. Article 7, paragraph 7. See Appendix 3 for the members of the Leadership Office.

<sup>73</sup> Interview with Sa'adi Pira, Sulaimaniyah, 9 June 1998.

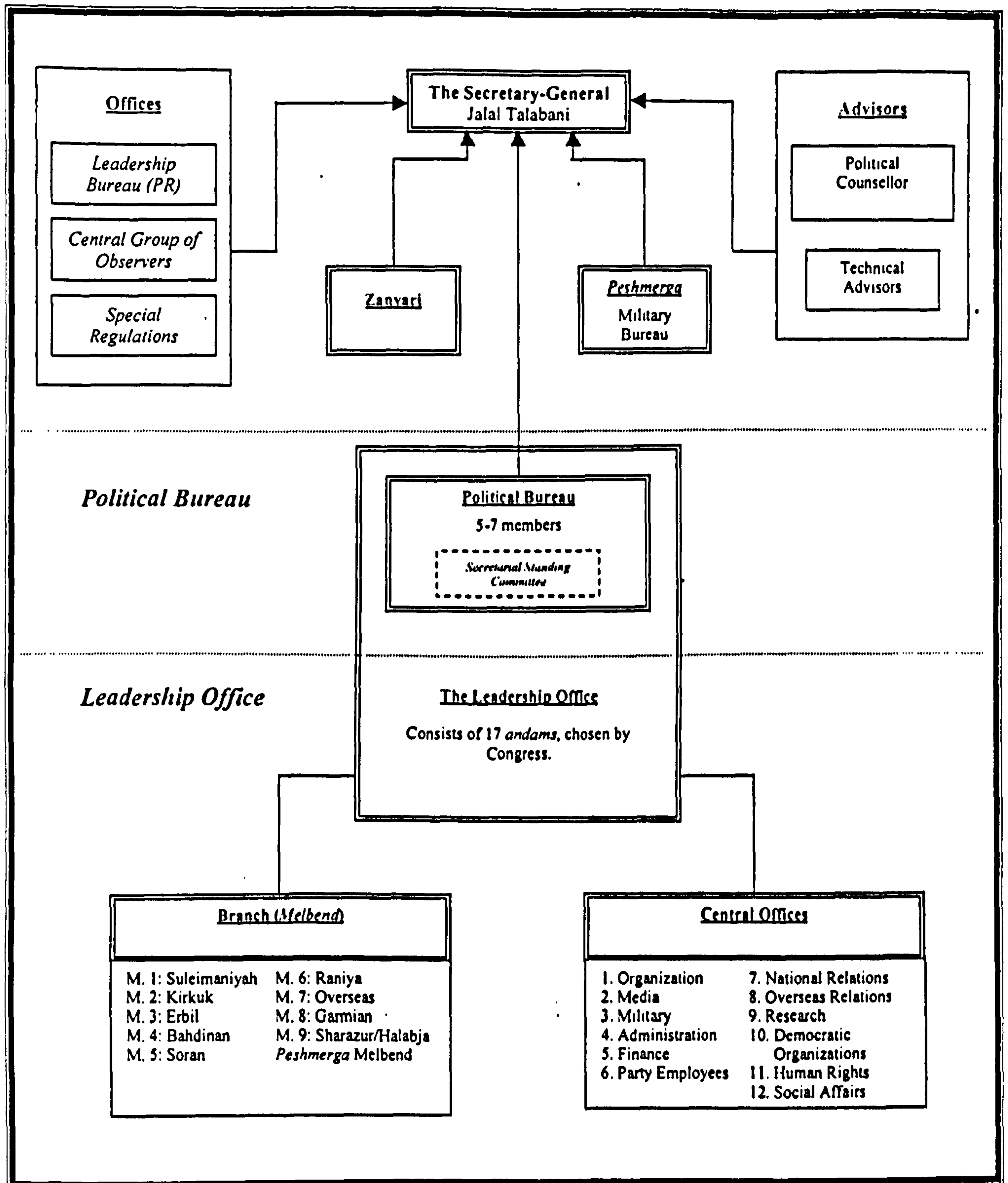

Figure 5.3: The Leadership Structure of the Patriotic Union of Kurdistan<sup>75</sup>

<sup>74</sup> Interviews with Arsalan Bayaez, Suleimaniyah, 24 May 1998; Sa'adi Pira, Suleimaniyah, 9 June 1998.

<sup>75</sup> Patriotic Union of Kurdistan (1993) *op. cit.*; interviews with Mohammad Tawfiq, Suleimaniyah, 14 May 1998; Arsalan Bayaez, Suleimaniyah, 24 May 1998; Sa'adi Pira, Suleimaniyah, 9 June 1998; Shwan Qliasani, Suleimaniyah, 18 June 1998; Omar Sa'id Ali, Suleimaniyah, 20 June 1998.

### 5.3.3.1.2 *Regional and Sub-Regional Structure*

The PUK geographic structure is headed by nine regional branches (*melbend*). When in Suleimaniyah, I had the opportunity to spend time in *melbendi yek* (Branch One), under the coordination of the PUK Political Bureau member Omar Sa'id Ali. As centre for the PUK in Suleimaniyah, it provides a useful comparison with *Leqi Du* of the KDP in Erbil. The structure of the regional and sub-regional structure is similar to that of the KDP, therefore Figure 5.2 is a useful reference. The following analysis highlights those areas which exhibit differences.

Within the Suleimaniyah *melbend*, there are 41 members, 18 of whom are women. The organization is headed by Omer Sa'id Ali along with two deputies. There is then a Steering Committee of 6 members, and beneath this there are the *Comita* Representatives, which number 23. The remainder of the members are in the offices of sectors, and each office is headed by one of the Steering Committee.<sup>76</sup>

The *melbend* is the PUK's central organizing office. Within the KDP areas, the *liq* manage the structure which is mainly geographical, with some trade union-type organizations as well. Within the PUK areas, it appears that the reverse is the case, with a greater focus on trade union organizations, and then geographic ones. To coordinate the activities of the PUK and provide feedback channels, the *melbend* has within it smaller organizations called *comita*. Within *melbendi yek* there are 23 such *comitas* mainly according to profession, with some for geographical locations in more rural parts of Suleimaniyah.<sup>77</sup>

The *comita* break down further into *kart*. The *kart* are built on a professional / geographical level such as a grouping of shops for example. Each member of the *Comita* Committee is responsible for one *kart*, which can number between 150 and 250 members. The head of the *kart* has a committee consisting of approximately 10 members. Each of these is responsible for a further subdivision known as a *pol*. A *pol* is composed of approximately 4 *shana* with each *shana* containing 10-15 people.<sup>78</sup>

<sup>76</sup> Interview with Omar Sa'id Ali, Suleimaniyah, 20 June 1998.

<sup>77</sup> Interview with Arsalan Bayaez, Suleimaniyah, 24 May 1998.

<sup>78</sup> Interview with Omar Sa'id Ali, Suleimaniyah; 20 June 1998.



### 5.3.3.1.3 *Conclusion*

The influence of both the heritage of the KDP and the impact of the structures of the extreme left factions such as *Komala* can be readily seen in the structural morphology of the PUK, with elements of both the geographic approach of the KDP, and the trade union-style approach to politics of the leftist groupings being combined. Furthermore, many of the terms used within the PUK were first employed within *Komala*. However, there are certainly more similarities than differences in the structure of these two parties. Nechervan Barzani commented upon this point, identifying that ideology was not the source of conflict between the KDP and PUK:

*“The programmes of both parties are virtually identical, and the goals are the same. The problem is one of who has power, and this may be solved by either elections or violence . . . . Believe me, there is no apparent external difference between the KDP and PUK, it is a personal matter.”<sup>79</sup>*

### 5.3.3.2 *The Decision-Making Process of the PUK*

If opinions relating to the decision-making process of the KDP are strong, the reverse is the case for the PUK. Within Iraqi Kurdistan, rather than being to identify one personality in which all power resides, as the KDP is so often accused, the power-exercising structures of the PUK are seemingly more opaque. Critics of the PUK describe Talabani's approach as being dictatorial, and PUK Political Bureau meetings as being highly charged and chaotic. It does appear that common preconceptions of the PUK within Iraqi Kurdistan see the party as being dominated by arguments and tense discussion. In this section, I provide an analysis of the PUK decision-making process, again both prescribed and actual. In the final part of this section, I again present a reading of contemporary PUK political activity in an attempt to provide insights into its decision-making processes.

#### 5.3.3.2.1 *The Prescribed Decision-Making Process of the PUK*

According to the official programme of the PUK, it is of no surprise that the highest official decision-making authority within the party is, again, the Congress.<sup>80</sup> The procedures by which it is organised involve a democratic voting system, and renewal once every two years. As in the KDP, the PUK have elections for the different party

---

<sup>79</sup> Interview with Nechervan Barzani, Saryrash, 21 May 1998.

positions up to the *melbend* and Central Offices. The heads of the *melbend* and Central Offices then form a plenum which then elects the congress. At the Congress, the Leadership Office is elected, the party programme reviewed, as are the policies of the PUK in general, again in an identical manner to the KDP. The Leadership Office then elects the Political Bureau. The Political Bureau is in charge of implementing the decisions of the Leadership Office between the two meetings of the Leadership Office, which is required to meet four times a year.<sup>81</sup>

However, whilst the PUK system may be seen to be identical to the KDP on paper, in practice it is very different as the last PUK Congress took place in 1992, and there has not been one since. Before the unification of the PUK took place in early 1990s into one party, the separate groupings of the union, *Komala* and *Shoresh Garan* held their own congresses, so there is not a continuous history of PUK Congresses as such. This fact is often seized upon by the KDP as an example that it is the PUK is command driven rather than the KDP.<sup>82</sup> Probably because the last congress was a considerable time ago, there is little discussion concerning congress activities when one investigates the decision-making process of the PUK. However, there is much more discussion regarding the grass-roots activities and the involvement of the rank and file of the party, which is possibly a reflection of its socialist origins.<sup>83</sup>

Within the PUK, the *comita* are identified as the main source of policies. According to PUK members, recommendations usually commence in the *comita*, and progress to the *melbend* before being forwarded to the Political Bureau. Within the Political Bureau, the forwarded issues are discussed beforehand in two separate Leadership Office meetings then recommendations are passed to the Political Bureau for a final decision. Decisions are therefore reached in the Leadership Office. The Political Bureau checks / ratifies these decisions, but may also take some decisions by its own authority.<sup>84</sup> This mechanism is less centralised than that found in the KDP, but may

---

<sup>80</sup> Patriotic Union of Kurdistan (1993) *op. cit.*, article 11.

<sup>81</sup> Interview with Mohammad Tawfiq, Kalarcholan, 7 August 1999.

<sup>82</sup> Sami Abdul Rahman noted that the PUK Political Bureau has changed several times since 1993, and never with the permission of the Party Congress. Interviews with Sami Abdul Rahman, Salahadin, 9 September 1999; Hoshiyar Zebari, Salahadin, 29 May 2000.

<sup>83</sup> The Second Congress of the PUK is due to take place in January-February 2001.

<sup>84</sup> Interviews with Kamal Khoshnaw, Suleimaniyah, 13 May 1998; Mohammad Tawfiq, Suleimaniyah, 14 May 1998; Arsalan Bayaez, Suleimaniyah, 24 May 1998; Sa'adi Pira, Suleimaniyah, 9 June 1998.



be characterised as a form of democratic centralism, as the final directive from the Political Bureau has to be implemented throughout the whole organization.

Within the Political Bureau, the Steering Committee appears to have greater predominance over activities than the KDP committee does over its own meetings. The secretary of the committee, Dr Kamal Fu'ad, develops the proposals before the meeting of the Political Bureau, where they are discussed and ratified. Before 1999, the Steering Committee used to be composed of the most dominant members of the Political Bureau. However, an important change occurred in May 2000. Talabani decided that members of the Political Bureau Steering Committee could only hold one post, and they all therefore had to choose whether to remain within the committee, or retain their additional posts. The result saw Kosrat Rasoul resigning from the committee, choosing to retain his position of Prime Minister. Jabar Farman chose to resign his position of Commander of PUK *Peshmerga* and retain his committee position. The other members of the committee are now Dr Kamal Fu'ad, Mohammad Tawfiq, Khadr Haji Ali, and Omer Abdullah.<sup>85</sup> Within the PUK, the Political Bureau members acknowledge that Talabani is the overall decision-maker, and he appears to be more active in this position than does Massoud Barzani. Many PUK members see Talabani as a form of guide for the party due to his institutional memory and widely reported voracity for reading and learning in general.<sup>86</sup>

The PUK operates a less rigid system than the KDP with regard to the membership of the Political Bureau. Whereas the KDP is proud of the fact that its Political Bureau only changes after a Congress, the PUK is equally proud of the fact of the fluidity of personal within its Political Bureau. The Political Bureau and the steering committee alters depending on who is in the country at the time.<sup>87</sup> The position of Talabani within this overall decision-making structure is interesting. While Talabani is indeed the head of all PUK Central Offices and *Peshmerga*, he apparently has few of his

---

<sup>85</sup> Interview with Jalal Talabani, Suleimaniyah, 11 September 2000. It was also decided that no minister could serve for more than three years, and a policy was forwarded to identify technocrats for ministerial positions rather than members of the PUK Political Bureau and Leadership Office. After this decision, the administration was reshuffled, with some non-PUK personnel being appointed to ministerial level, for example, Dr Yedgar Hishmat to the Ministry of Health and Dr Jamal Fu'ad to the Ministry of Humanitarian Affairs & Cooperation.

<sup>86</sup> Interviews with Chalaw Ali Askari, Suleimaniyah, 10 June 1998; Talabani, Kalarcholan, 14 September 1999.

<sup>87</sup> Interview with Arsalan Bayaez, Suleimaniyah, 24 May 1998.

own personal offices as Massoud Barzani does, and makes a specific point of visiting as many of the lower offices of the PUK as often as possible.<sup>88</sup> The political openness of Talabani is often compared to the more reserved actions of Massoud Barzani. During the summer of 1998, for example, Talabani visited the Suleimaniyah *melbend* twice to discuss separate party issues with its members.

#### 5.3.3.2.2 *Criticisms of the PUK Decision-Making Process*

Even with the lack of a recent Congress, the evidence from interviews with members of the PUK indicate that the organization is one which operates a convincing democratic process down through the grass-roots of its structures and up into the Political Bureau as well. However, the dominance of Talabani in all the affairs of the PUK is often quoted as a major weakness by the KDP especially, as is the existence of supposed power groupings within the Political Bureau, meaning that many PUK decision-making meetings are weakened by bitter internal disagreements.<sup>89</sup> Furthermore, according to Hoshyar Zebari of the KDP, members of the PUK leadership have confided in him that the decision-making process of the KDP is more coherent than that of the PUK, with Talabani proving to be somewhat argumentative even with decisions where consensus had been achieved.<sup>90</sup>

Certainly, the PUK is not a totally unified party. As we have seen, its strength in the past has been secured by appealing to a wide range of leftist-sentiments by being an umbrella of different groupings and, even now, the PUK is still characterised by some vertical divisions within its structure. However, should the fact that the PUK Political Bureau decision-making process is often volatile means that it is any less effective? The members of the Political Bureau do not deny that, at times, their meetings are often highly charged. A senior Political Bureau member, Mohammad Tawfiq, noted that while there is free discussion within the meetings, the proceedings are of course dominated by strong personalities.<sup>91</sup> In regard to this, Talabani himself said, with strong inference to the KDP, that "*in the Political Bureau, I am not always in the majority. Each member obviously has a personality, and their own prestige.*

---

<sup>88</sup> *Ibid.*

<sup>89</sup> The KDP Political Bureau member (Eleventh Congress) Arif Taifour, noted to me that when Talabani is angry, nobody will disagree with him. Interview with Arif Taifour, Salahadin, 1 September 1999.

<sup>90</sup> Interview with Hoshyar Zebari, Salahadin, 29 May 2000.



*We are not all yes men.*"<sup>92</sup> Furthermore, he noted that "it is a dream that [the] PUK is divided through our arguments. It is a strength, showing the party is alive. It is a signal of the capability and seriousness of the party."<sup>93</sup> According to Talabani, the result of this lack of command from any one person within the decision-making apparatus has meant that the PUK is not constrained, and, for this reason, may sometimes appear to be chaotic. However, he also stated that he was quite prepared to encourage this as a means of promoting a democratic process within the party.<sup>94</sup>

With regard to the presence of strong power groupings within the PUK, again, Talabani did not deny this. He instead identified it as evidence illustrating that those politicians who have acquired a great degree of popular support are now in the Political Bureau, whereas those who have lost support are no longer in office. He noted that the original founders of the PUK are either no longer in the party at all, or are in the lower Leadership Office, such as Adil Morad for example, a founder member of the PUK who is now in charge of the media office. Members who were not in the PUK from the beginning but joined at a later stage and then became popular, such as Kosrat Rasoul, are now in the Political Bureau and have developed influential positions due to their popular support.<sup>95</sup>

However, even with such observations from Talabani, the internal political dynamics of the PUK suggest that the party is characterised by vertical divisions which originate in the Political Bureau. These divisions became particularly apparent after 31 August 1996 when the PUK was forced out of Erbil. It is therefore at this date that the analysis of the contemporary power structure of the PUK will commence.

### 5.3.3.3 Assessment and Analysis of the PUK Power Structure

The PUK under the leadership of Talabani has been officially in existence since 1975, yet its roots go back much further. As a party of the urban intelligentsia, it enjoys a strong support base in urban areas, similar to that enjoyed by the KDP in the more rural areas. However, unlike the KDP, the PUK does not possess the same unity

---

<sup>91</sup> Interview with Mohammad Tawfiq, Kalarcholan, 7 August 1999.

<sup>92</sup> Interview with Jalal Talabani, Kalarcholan, 14 September 1999.

<sup>93</sup> Interview with Jalal Talabani, Suleimaniyah, 11 September 2000.

<sup>94</sup> Interview with Jalal Talabani, Kalarcholan, 14 September 1999.

<sup>95</sup> *Ibid.*

and internal cohesion and, indeed, disunity has been a characteristic avidly promoted by Talabani himself. While the PUK may be described as being a more democratic party than the KDP and perhaps possessing a more dynamic leadership, the party is divided by design.

#### 5.3.3.3.1 Power Groupings

The leadership technique of Talabani can be identified as managing the natural divisions apparent in the PUK. Talabani's leadership tactic has been characterised by managing to balance two opposing factions. For example, between the radical *Komala* with the more traditional *Shoresh Garan*, and now, balancing between the PUK organization of Erbil and that of Suleimaniyah. Figure 5.4 illustrates the development of the divisions within the PUK.

**Figure 5.4 :The Divisions of the PUK, 1975-1999**

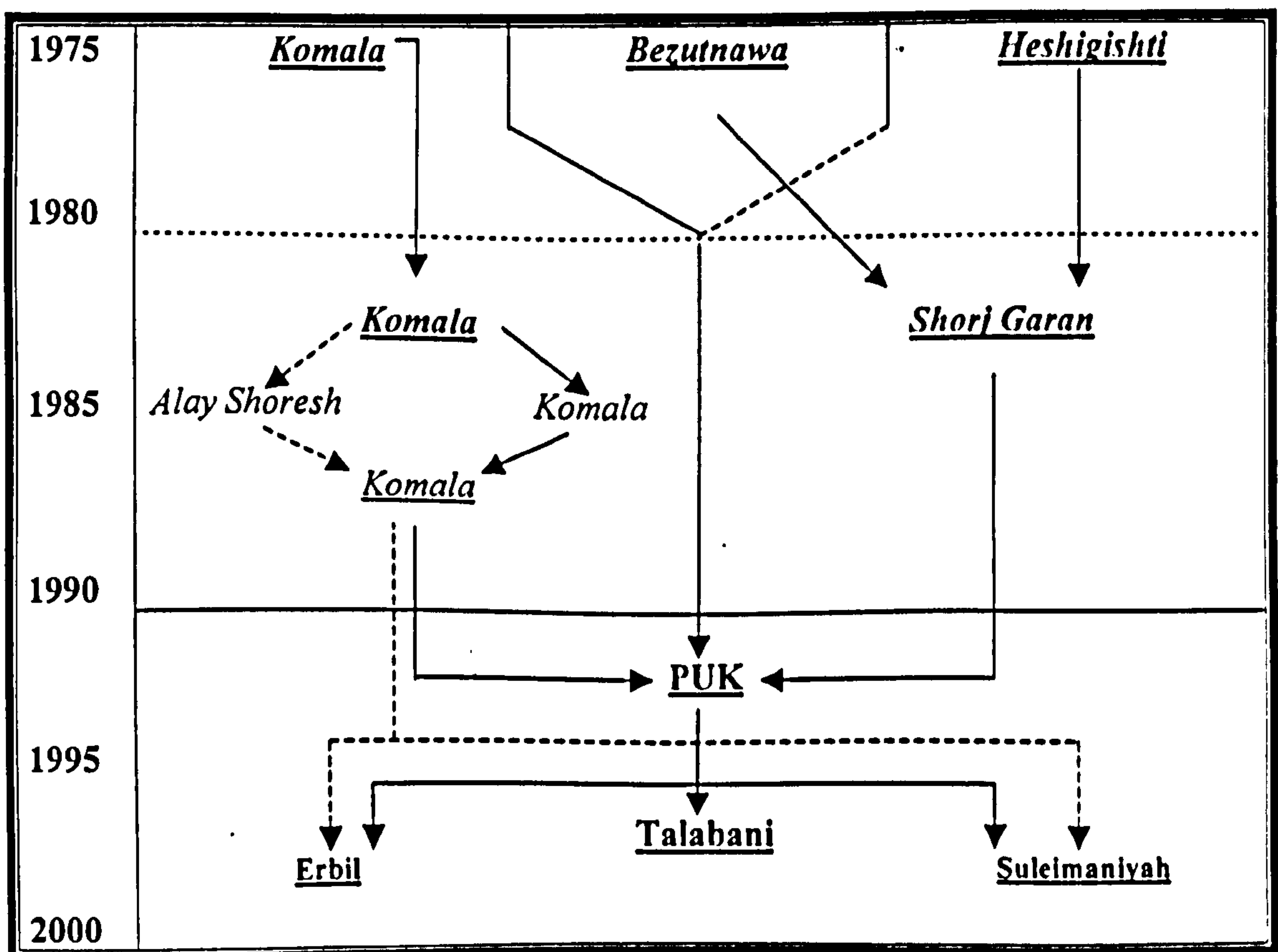

Throughout its history, the PUK has been characterised by some form of internal division. Such a division is a manifestation of the promotion of socialist ideology within an inherently traditional, tribal, society. The successful management of this



division is one of the primary reasons why the PUK remained popular throughout the 1980s. It is also apparent that Talabani's skilful management of these inherent stresses and strains have benefited his position as leader, as he has often managed to associate the most popular of the PUK leaders with his own charismatic personality. Talabani achieved this task in the 1980s when this division was apparent in a planned manner with the existence of the two wings of the PUK, the *Komala* and *Shoreh Garan*.

However, in the late 1990s, the division within the PUK was more geographical rather than ideological. Particularly becoming apparent after the GOI-KDP invasion of Erbil in 1996 and subsequent PUK retreat to Suleimaniyah, the PUK division can be characterised as being between those members from Suleimaniyah, and those from Erbil.

The PUK organization within Erbil, led by Kosrat Rasoul, fled to Suleimaniyah. The integration of the Erbil personnel with the Suleimaniyah organization has not proven to be a straightforward task for the PUK. However, unlike past divisions, this new division is potentially difficult for Talabani to manage as Kosrat enjoys an unprecedented popular support base. Those *peshmerga* units from Erbil, and indeed many from Suleimaniyah, pledge their allegiance to Kosrat, and he is also the Prime Minister of the KRG based in Suleimaniyah.

In the aftermath of the evacuation of Erbil by the PUK, Suleimaniyah became literally overcrowded with too many PUK politicians, particularly as Kosrat brought many of his Erbillian supporters and civil servants with him.<sup>96</sup> The Suleimaniyah equivalent at this time was Jabar Farman, the Commander of PUK *peshmerga*, who had achieved a high degree of notoriety by defeating the IMK in 1994. Kosrat naturally assumed the position of Prime Minister of the KRG (Suleimaniyah) and put many of his Erbillian staff in key positions in the ministries. This was administratively a very wise move, as many of the Erbillian staff had experience of administration and the new administration was in a position to start work quickly.

---

<sup>96</sup> In terms of numbers, however, Jalal Talabani noted that, in August 1996, the total number of PUK members in Erbil was approximately 45,000. Of these, only 5,000 evacuated to Suleimaniyah. Interview with Jalal Talabani, Suleimaniyah, 11 September 2000.

Talabani proceeded to play each of these characters off against the other. Kosrat was appointed as Prime Minister of the KRG, and Jabar remained in command of the *peshmerga*. However, Kosrat was politically active in developing his Erbillian power base and eroding what many consider to be the old guard of the PUK, whereas Jabar appeared to be allying himself more closely with Talabani and drawing his strength from this source. As already stated, Suleimaniyah became a politically claustrophobic place with the arrival of the Erbillian element of the PUK with tension immediately became apparent between the offices of the Suleimaniyah Governor and Erbil Prime Minister. Mohammad Tawfiq noted that:

*“There were originally problems with all the Erbillians coming to Suleimaniyah, but they were mainly problems of logistics as Suleimaniyah is a much smaller place than Erbil.”<sup>97</sup>*

The territory controlled by the PUK had been cut drastically, and the small city of Suleimaniyah now had a full executive cabinet alongside the offices of the Governor of Suleimaniyah, essentially making them moribund. Kosrat succeeded in replacing the governors (Feyeradun Abdulkadir and then Salar Aziz) with his old Erbillian Chief of *Asayash* (police), Hackam Khadr Hama Jan. The strength of Kosrat has now reached a point where he is almost unassailable. In discussing this, Sami Abdul Rahman of the KDP stated that *“Kosrat has always been important for the PUK as they considered that he could take Erbil for them. He couldn't, but he is now taking Suleimaniyah instead.”<sup>98</sup>*

However, it should be noted that, perhaps more than any other politician in Iraqi Kurdistan, Kosrat Rasoul is seen as a man of people. His support base is strong particularly amongst the working classes of the region, and his exploits as a *peshmerga* have generated a significant degree of idolatry. Similarly, his fighting history means that he feels free to speak his mind to any politician of either the KDP or PUK. Within the PUK, he is obviously a player of paramount importance and influence. However, he is also respected by most cadres of the KDP, and particularly by Massoud.<sup>99</sup>

<sup>97</sup> Interview with Mohammad Tawfiq, Kalarcholan, 7 August 1999.

<sup>98</sup> Interview with Sami Abdul Rahman, Salahadin, 9 September 1999.

<sup>99</sup> The relationship between Kosrat and Massoud is interesting as it appears to have commenced rather antagonistically. Kosrat was one of the Commanders of the PUK forces which expelled the KDP from Erbil in 1994. In a subsequent news propaganda report, Massoud taunted the pedigree of Kosrat



A further change in this complex game has occurred with the return of the traditional second-in-command of the PUK, Nawshirwan Mustafa, from an extended sojourn in London. His reappearance has provided the members of the PUK from Suleimaniyah with a political personality of at least equal abilities and ambition to Kosrat. The position of Talabani in this potential power struggle is one of interest. Reports indicate that Talabani requested the return of Nawshirwan in order to preserve the balance of power within the PUK. Certainly, Nawshirwan is gaining in influence, especially as he was already a hugely popular figure within Iraqi Kurdistan in general and Suleimaniyah in particular before he arrived. He also commands a great deal of loyalty due to him previously being the leader of *Komala*, which formed the core of the *peshmerga* throughout the 1980s. Nawshirwan was elected to the Political Bureau of the PUK in 2000, even though he did not want the position and did not stand for it.<sup>100</sup> His position is one of political counsellor to the PUK in general, and he enjoys a position of being recognised as an academic authority on Kurdish politics, as well as the reputation of being the charismatic leader of *Komala*:

#### 5.3.3.3.2 Conclusion

The PUK is in a period which it will be strengthened or be divided. The divisions within the party are highly unstable. However, Kosrat is perhaps the one Kurdish politician who possesses the ability to unite disparate political groupings around him. His reputation as a *peshmerga*, and particularly the stories surrounding his evacuation from Erbil in 1996 elevated him to a supremely powerful position within the PUK, one which can only be countered by the ever-impressive Nawshirwan Mustafa. The balance of power within the PUK between these two persons in the future will be a key dynamic in the future development of Kurdish politics in Iraq.

The management of this balance, as always, lies with Talabani. For the PUK to successfully negotiate the forthcoming years intact will rest on the ability of Talabani, and, to a lesser extent Nawshirwan and Kosrat, in guiding the fractious party through this difficult period. In 2000, the PUK has staged a remarkable recovery from instability. As a political party, the PUK is still very popular within

---

Rasoul, stating that nobody knew his father, and that Massoud is the son of the legendary Barzani. Kosrat responded by saying that his father was a poor man, but he still managed to remove the famous man's son. Since this, however, Massoud in particular appears to rate the abilities of Kosrat.

Suleimaniyah and also in Erbil. The population seem to find it easy to give its support to the enigmatic Talabani and his cohorts, and the washing of the PUK's dirty linen in public is something which the Iraqi Kurdish population have been used to for a considerable period of time. Talabani's health appears to be reasonably strong despite rumours to the contrary and, with the return of Nawshirwan and evidence of Kosrat and Nawshirwan cooperating, the tensions within the PUK are decreasing. Again, this could be a reflection of Talabani recognising the popular position of Kosrat, but it has surely been facilitated by the shrewd political actions of Nawshirwan.

#### 5.3.4 Conclusion

The above analysis of the PUK and KDP, at a variety of different levels, has indicated many areas of similarities and differences. Structurally, and officially, the two parties exhibit few differences from each other. Both of their internal organizations are similar, and both have a similar structure of authority. However, when the power structures of both parties are assessed, it is clear that they are radically different, with the KDP being characterised by a strong central leadership and by democratic centralist tendencies. While there are divisions apparent within the leadership of the KDP, they are being managed in a subtle manner by Massoud, and the stability of the party should remain. Within the PUK, the central leadership possesses strong personalities with their own support bases and, while they are all loyal to Talabani, the decision-making process within the PUK suffers from these divisions. The leadership of the PUK has gone a considerable way to easing some of the tensions which were apparent in their midst towards the end of the 1990s, but there is still some way to go before it can be said that the PUK is as stable as the KDP.

Perhaps most importantly, however, both parties exhibit strong patrimonial tendencies within their leadership structures, with both Massoud and Talabani manoeuvring themselves into positions where they remain in command of their organizations, while attempting to encourage more democratic processes within their respective parties. In 2000, it appears that these internal dynamics are being

---

<sup>100</sup> Interview with Jalal Talabani, Suleimaniyah, 11 September 2000.



controlled effectively by both parties, and that some form of internal balance is being achieved, particularly in the KDP. However, there are still many difficulties ahead for both parties, and time is needed for both Massoud and Talabani to further increase the stability of their parties before they are once again reunited into the same political system.

If the Washington Agreement is successful and the KDP and PUK are indeed reunited into one system, it is highly likely that the instabilities apparent in the divided political system will be magnified, as they were between 1994 and 1996. Neither the KDP nor the PUK are, as yet, political mature enough in terms of the stable operation of their internal decision-making processes for them to become involved in a political system in which they are not the undisputed main players. Until this stability is obtained, a divided consociational political system allows them to target their internal inconsistencies without being overtly concerned with the activities of 'the other side'. Any united system without adequate consociational safeguards, with both parties in one government for example, would simply result in a transference of internal party instabilities into the greater political arena.

## Chapter 6

### The Organizational Structure of the Kurdistan Regional Government

#### 6.1 Introduction

Self-governance has developed from being an ethereal aim of the political parties to being a reality at the core of the political system. The events of the early 1990s, which commenced with the Iraqi invasion of Kuwait and culminated with the defeat of Iraq, the *rapareen*, and the withdrawal of the administrative organs and military forces of the GOI from the north of the country provided the Kurds with a unique opportunity to administer their own region. It is not an exaggeration to consider the establishment of the KRG as being the most important single event in the history of the Kurdish national movement in Iraq.<sup>1</sup>

Criticism of the Kurds' attempts to govern themselves is widespread both in the academic literature and journalists' accounts. Academics have questioned the success of the entity particularly in terms of its internal security and order. Gunter, for example, after noting the formation of the KRG in 1992, begins his analysis of the "*Kurdish Predicament in Iraq*" by asking "*How did everything go so wrong*"?<sup>2</sup>

To criticise the KRG experience up until 1996 is a relatively easy task. The Kurdish political parties commenced with good intentions with a multi-party election in May 1992. The subsequent 50-50 system was a workable but extremely fragile consociational-type of governmental organization, dependent upon the preservation of a balance of power between the KDP and PUK. When this balance was altered, the system became unworkable and provided yet another catalyst for the decline into confrontation and conflict.

It is incorrect to continue with these criticisms with regard to the two third cabinets of the KRG which have been in existence since the summer of 1996. It is true that the

---

<sup>1</sup> This statement is strongly supported by Nawshirwan Mustafa of the PUK. Interview with Nawshirwan Mustafa Amin, Suleimaniyah, 29 July 1999.



events of August of that year were one of the most painful of the 1990s for the Kurds and damaged the unity of the party political front. However, the resultant situation is now characterised by a stable structure by which the divided KRG is actively governing the region, albeit with an arrangement that is cumbersome and inefficient.

It is my intention to analyse the KRG in two separate chapters. It is first necessary to concentrate on the failings of the first and second cabinets which led to inter-factional fighting, and to then focus on the characteristics of the divided third cabinets. It is in my opinion that the Kurds stumbled onto a system which provides the answer to the question of how to satisfy both the KDP and PUK, at the same time as alleviating the concerns of neighbouring states and the western powers. Such an analysis is only possible by first examining the internal structure and framework of the KRG, and then drawing conclusions regarding its role, success and operational mechanisms. Therefore, I will address these morphological aspects of the KRG and prescribed operating mechanisms in this chapter, and, investigate the decision-making process and incipient strengths and weaknesses of the system in the proceeding chapter.

### 6.1.1 Aims

The existence of the KRG is a cause of great concern to the neighbouring states which do not wish to see the strengthening of the Iraqi Kurdish political system by the founding and subsequent institutionalization of an indigenous administration. Therefore, the analysis of the governmental system is as difficult as that of the political parties themselves. Furthermore, as Iraqi Kurdistan is still under double sanctions, many of the procedures expected of an administration are often chaotic and therefore difficult to analyse. The aims of this chapter are therefore:

1. To provide a political history of the formation of the KRG;
2. To analyse the elections of 1993, and;
3. To model the organizational structure / morphology of the KRG.

---

<sup>2</sup> Gunter (1999a) *op. cit.*, pp. viii – ix.

### 6.1.2 Structure

Before commencing with the analysis of the organs of governance and administration of the Iraqi Kurdish political system, it is essential to develop an accurate understanding of the layout of the constituent parts of the KRG (morphological modelling). Then, it is necessary to analyse the prescribed manner in which the system is conjectured to work (information flow modelling).

Such an exercise serves numerous purposes. First, it illustrates the morphological sophistication of the KRG. Second, it provides the starting point of the forthcoming analysis of the decision-making process. The KRG has undergone many changes over its lifetime and it is beneficial to have some comprehension of what the KRG originally was and has developed into. Third, the provision of a morphological analysis of the KRG provides the first step of understanding the decision-making process. For the purposes of this chapter, I am choosing to divide the KRG into the KNA (the assembly), the KRG (the executive), and the judiciary. The role of leadership is constantly referred to in subsequent sections, particularly when the decision-making process and control of policy is analysed.<sup>3</sup>

### 6.2 The Aftermath of the *Rapareen*

The short period after the withdrawal of the GOI from Iraqi Kurdistan may be seen to be instrumental in the development of the *de facto* state in Iraqi Kurdistan. The IKF was forced to make rapid decisions regarding the emergency administration of the liberated areas, and to decide upon the best method of governing Iraqi Kurdistan without incurring the wrath of neighbouring states. Alongside these stiff tasks, the IKF was facing a rapidly deteriorating military situation, then negotiations with the GOI, and then an internal economic embargo and the withdrawal of all the administrative organs of the central government.<sup>4</sup>

After the withdrawal of the GOI, the leaders of the IKF held several meetings with the technocrats of Iraqi Kurdistan. In describing these meetings, Massoud Barzani

---

<sup>3</sup> This division corresponds with standard divisions found in texts of comparative government. I am choosing not to address the military as the military capability of the KRG is still in the hands of the dominant political parties and is not controlled by the KRG itself. For comparative government texts, see Hague, *et. al.* (1992) *op. cit.*; Blondel (1995) *op. cit.*; Peters (1998) *op. cit.*

<sup>4</sup> Interview with Jawher Namiq Salim, Erbil, 8 September 1999.



told them that his experience, and the experiences of the *peshmerga* were in destroying bridges, cutting electricity and destroying roads.<sup>5</sup> Massoud therefore claimed that he and the leadership of the IKF requested assistance from builders, engineers and technocrats in order to assist in the rebuilding of the infrastructure and administration of the region. When focusing on the role of the KDP in this exercise, Massoud stated that *“the KDP had the assistance of many experts who cooperated with the political parties to provide stability. There was good coordination between the peshmerga and the technocrats.”*<sup>6</sup>

### 6.2.1 Emergency Government

The initial governance of the region was exercised through the governorate structure and the *peshmerga* of the political parties.<sup>7</sup> It is important to realise that, at this time, the majority of the population was in urban areas due to the destruction of the rural infrastructure which had taken place over the previous ten years. This necessitated the need for an emergency system for the cities and towns.<sup>8</sup> Nawshirwan Mustafa noted that, *“. . . . at this time there was not too much left to govern. The Iran-Iraq war had wiped out the villages, and the Anfal had destroyed the rest. All that was left were the cities and the collectives, no villages or towns.”*<sup>9</sup>

The IKF divided the urban areas into regions governed by committees comprised of members from the different parties of the IKF. Suleimaniyah, for example, was governed by a committee composed of the PUK, KDP, PASOK, and the KSP.<sup>10</sup> In this emergency period, the governing committee commonly reflected the political colouring of the region under its control, meaning, in practical terms, that each region was controlled by a particular political party.<sup>11</sup>

The situation lasted for one month before the GOI launched their successful counterattack against the *peshmerga* of the IKF, capturing most of the areas

<sup>5</sup> Interview with Massoud Barzani, Saryrash, 22 August 1999.

<sup>6</sup> *Ibid.*

<sup>7</sup> *Ibid.*

<sup>8</sup> Interviews with Nawshirwan Mustafa Amin, Suleimaniyah, 10 August 1999; Massoud Barzani, Saryrash, 22 August 1999.

<sup>9</sup> Interview with Nawshirwan Mustafa Amin, Suleimaniyah, 10 August 1999.

<sup>10</sup> Interview with Mohammad Tawfiq, Kalarcholan, 7 August 1999; Nawshirwan Mustafa Amin, Suleimaniyah, 10 August 1999; Massoud Barzani, Saryrash, 22 August 1999; Arif Taifour, Salahadin, 1 September 1999.

previously lost.<sup>12</sup> The GOI then withdrew, placing Iraqi Kurdistan under an economic embargo from the south as well as from the international community. The IKF then returned to the area committee system of governance, combined with the structure of the governorate, until the elections of 1992.<sup>13</sup> There was extensive reliance upon the organs of the governorate structure during this emergency period. Even with the absence of central government, the governorate structure remained intact, even if it was simply nominal offices with no staff because all of the pro-GOI civil servants had fled. Even so, the Kurdish civil servants had experience of working within this system under the GOI administration.<sup>14</sup>

This initial emergency system of governance was haphazard in the extreme and had many serious problems, with the IKF displaying neither consistent decision-making powers nor the ability to fully control its own forces.<sup>15</sup> Jalal Talabani identified the crux of the initial problems when he stated that, "*we came from the mountains, we were trained as fighters, and now we had to run cities.*"<sup>16</sup> Further problems were identified by Gunter who, quoting a report from early 1992, forwarded that "*. . . the remnants of Iraqi civil authority in this region, deprived of leadership and money from Baghdad but lacking direction from any central Kurdish authority, are nearly paralysed.*"<sup>17</sup>

Furthermore, the decision-making process within the newly founded Kurdish power structure proved to be problematic. In a scenario which would appear after the elections of 1992, the Kurdish drive for fairness and democracy within its fledgling decision-making apparatus was hamstrung by the inclusion of provisions rarely found even in established liberal democracies. Each member of the IKF, for example,

---

<sup>11</sup> Talabany (1999a) *The Kurdish View on the Constitutional Future of Iraq*. London, p. 144.

<sup>12</sup> For an account of the counterattack of the forces of the GOI, see the interview with Nawshirwan Mustafa in Randal (1998) *After Such Knowledge, What Forgiveness: My Encounters with Kurdistan*. New York: Farrar, Straus & Giroux, pp. 46-50.

<sup>13</sup> Interview with Nawshirwan Mustafa Amin, Suleimaniyah, 10 August 1999.

<sup>14</sup> Interviews with Sami Abdul Rahman, Salahadin, 27 June 1998; Hoshyar Zebari, Salahadin, 29 May 2000.

<sup>15</sup> Interview with Hoshyar Zebari, Salahadin, 29 May 2000.

<sup>16</sup> Interview with Jalal Talabani, Kalarcholan, 14 September 1999.

<sup>17</sup> Gunter (1993a) *op. cit.*, p.88, quoting "*Barzani Cited on Disputes within Kurdistan Front*," *Al-Hayat*, London, 22 December 1991, p.5, cited in *FBIS-NES*, 3 January, 1992, p. 25.



had the ability to exercise a veto power, resulting in few decisions of importance being made.<sup>18</sup>

### 6.2.2 The Establishment of Legal Provisions for Government Formation

The IKF desperately needed to formulate some form of constitutional procedure before tackling the issue of self-governance. However, their political position was treacherous. The withdrawal of the GOI administration from Iraqi Kurdistan was seen by many of the Kurdish leadership as a trap. The temptation to declare an autonomous state was huge. However, such an action would have been met with strong opposition from Iran and Turkey, as well as Iraq itself. Mohammad Tawfiq noted that *"we could have no constitution, as such, as the IKF had to exercise extreme caution in promoting separatist type changes in 1991."*<sup>19</sup>

The direction decided upon by the IKF was to legitimise its authority by forming an assembly with the aim of administering the region and establishing a legal authority by democratic elections.<sup>20</sup> Ever mindful that its regional neighbours would see this move as an exercise in independence rather than as a step towards emergency administration in the short-term, the leadership of the IKF formed an electoral steering committee from judges and lawyers rather than politicians. Their task was to ascertain the best methodology for the construction and formation of the proposed KNA.<sup>21</sup> Table 6.1 lists the members of the committee.

The committee met between 23 December 1991 and 28 January 1992. Its findings were accepted and confirmed by the political leadership of the IKF and formed the core of Law Nos. 1 and 2 of 1992: the Laws of the KNA and the Leader of the

<sup>18</sup> Gunter (1993a) *op. cit.*, p. 89.

<sup>19</sup> Interview with Mohammad Tawfiq, Kalarcholan, 7 August 1999.

<sup>20</sup> There is some disagreement between the KDP and PUK as to which party forwarded and supported the idea of handing over power to a democratically elected assembly. Massoud Barzani, Sami Abdul Rahman and Hoshiyar Zebari state that it was a KDP initiative, Jalal Talabani and other members of the PUK said that it was the PUK which promoted the initial committee structure of emergency government and then forwarded the development of a national assembly. Similar disagreements are apparent over the issue of the need for a constitution. Interviews with Sa'adi Pira, Suleimaniyah, 9 June 1998; Fuad Massoum, London, 21 June 1999; Massoud Barzani, Saryrash, 22 August 1999; Arif Taifour, Salahadin, 1 September 1999; Jalal Talabani, Kalarcholan, 14 September 1999; Hoshiyar Zebari, Salahadin, 29 May 2000. Kurdistan National Assembly (1995) *Demokrasi Parliament u Hukumeta Basura Kurdistan*. South Kurdistan: SILC.

<sup>21</sup> Mohammad Tawfiq noted that the Iranian Government stated that, at this time, it preferred to see a vacuum rather than an administration develop. Interviews with: Dr. Kamal Fu'ad, Suleimaniyah, 5 May 1998; Dr. Shafiq Qazzaz, Erbil, 18 May 1998; Mohammad Tawfiq, Kalarcholan, 7 August 1999.

**Table 6.1: The Electoral Steering Committee of 1991-1992<sup>22</sup>**

	<b>Name</b>	<b>Position</b>
1.	Rashid Abdul Kadil	Judge, President of Kurdistan Supreme Court
2.	Marouf Ra'uf	Judge, Minister of Justice in the Regional Ministry's of the Front
3.	Nathem Hwaezi	Judge, Head of Erbil Court of Appeal
4.	Ameer Hwaezi	Judge, Member of Erbil Court of Appeal
5.	Shamssaddin Mufti	Lawyer
6.	Mohamad Baban	Lawyer
7.	Dr Sa'adi Barzinji	Dean of College of Law and Policy in Salahadin University
8.	Dr Khurshid Shawkat Rowanduzi	Professor in College of Law and Policy in Salahadin University
9.	Mustafa Askari	Lawyer
10.	Firsat Ahmed	Lawyer, Secretary of Iraqi Kurdistan National Assembly
11.	Dr Qais Dewali	Lawyer, Councillor of Iraqi Kurdistan
12.	Hassan Abdul-Karim Barzinji	Lawyer, Councillor of Iraqi Kurdistan
13.	Bakhtiyer Haydar	Lawyer, Councillor of Iraqi Kurdistan
14.	Khadir Jabari	Minister of Justice, Second Cabinet, Representative of the IKF (KSP)
15.	Franso Hariri	IKF Representative (KDP)

Kurdistan Liberation Movement. These laws, as stated, were not intended to be constitutional, but were rather identified as rules governing the relationships between different political and administrative powers.<sup>23</sup> However, while in name these documents were not a constitution, in style and in practice they moulded the political characteristics and direction of the *de facto* state.

<sup>22</sup> Kurdistan National Assembly (1995) *op. cit.*; interview with Nawshirwan Mustafa Amin, Suleimaniyah, 10 August 1999.

<sup>23</sup> Interview with Mohammad Tawfiq, Kalarcholan, 7 August 1999.



### 6.2.2.1 Law No. 1, The Law of the Iraqi Kurdistan National Assembly

Law No. 1, signed on 8 April 1992,<sup>24</sup> detailed the principles and procedures of the proposed KNA; the electoral rules and procedures, conditions of candidature, the voting procedure, and the role of the KNA. Both the KDP and PUK continuously refer to Law No.1 as having immense political, historical and cultural meaning for the Kurds, and they have a strong case for doing so. Falak al-Din Kakai, a member of the KDP and subsequently elected MP in the KNA, described Law No. 1 as being;

*“ . . . the first law in the history of modern Iraq to be enacted by a de facto Kurdish authority exercising power and assuming decision-making rights within the Kurdish region of Iraq, irrespective of the central government in Baghdad. The resolution to hold a general election in Iraqi Kurdistan in May 1992 was a crucial element in this assertion of authority.”*<sup>25</sup>

The principles and procedures described in Law No. 1 for the formation of the KNA were developed from the study of parliamentary democracies in a variety of countries.<sup>26</sup> The main principles and procedures are summarized as follows:<sup>27</sup>

1. The KNA should consist of no less than 100 members, each representing approximately 30,000 people (Section 1, article 1).
2. The KNA operates according to a secret ballot (Section 1, article 2).
3. Equality exists between men and women in electoral candidature (Section 5, article 1).
4. The election of candidates is according to proportional representation, and according to the party lists (Section 8, Article 36.1).
5. Parties have to secure 7% of the overall vote to obtain seats in the KNA. Exceptions were made for the Christians (Section 8, Article 36.3).<sup>28</sup>

<sup>24</sup> Law No. 1 was signed by the 'political leadership of the Iraqi Kurdistan Front', which consisted of the following members: Jalal Talabani (PUK), Massoud Barzani (KDP), Abdullah Agreen (PASOK), Rasul Mamand (KSP), Aziz Mohammad (KCP), Sami Abdul Rahman (KPDP), Kadir Aziz (Toilers), Yakub Yousif (ADM).

<sup>25</sup> Kakai (1992) *op. cit.*, p. 118. Kakai refers to Law No. 1 as 'Rule 1 of the Iraqi Kurdistan Front'. During my sojourns in Iraqi Kurdistan, the article in question was always labelled as a 'Law'. However, as the use of the word 'Law' does carry some constitutional connotations, it is perhaps understandable why Kakai uses the term 'Rule'.

<sup>26</sup> Interview with Nechervan Barzani, Saryrash, 21 May 1998.

<sup>27</sup> The main sources for this section come from the text of Law No. 1 itself; a subsequent publication by the Kurdistan National Assembly entitled *Demokrasi Parliament û Hukûmeta Basûba Kurdistan* (Parliamentary Democracy and Governance in Southern Kurdistan); and interviews with individuals involved in the formation of the laws.

<sup>28</sup> This ruling was subsequently dropped.

6. It is not permitted to combine a Council position with that of Public Staff (Article 4.1)
7. An electoral committee to be established on order to supervise the proceedings of the election. The duties of this committee includes the positioning of ballot boxes, establishing local committees, and provide guidance to the electorate (Article 6.1 – 6.3).

The conditions of candidature forwarded by Law No. 1 were similarly constructed with reference to established liberal democracies. A candidate for election to the KNA had to meet the following criteria:

1. Be a civilian of Iraqi Kurdistan, and resident in Iraqi Kurdistan.
2. To be fully qualified and be of at least 30 years of age.
3. The candidate must be literate.
4. The candidate should not have committed violations of moral codes.
5. The candidate should not have committed murder or larceny.
6. To not have been involved in crimes planned by the central government against the population of Iraqi Kurdistan.

The elections were based upon a system of proportional representation with each competing party submitting a list of candidates. The liberated area was divided into 4 electoral regions,<sup>29</sup> and each region was then divided into electoral centres,<sup>30</sup> dependent upon the decision of the electoral committees.<sup>31</sup> Parties were free to coalesce, which many did including the PUK with the Toilers' Party, and the Islamist parties merged (although remained dominated by the IMK). The parties representing the Christian minority competed on a closed list, thereby guaranteeing that there would be 5 Christian seats within the KNA.

#### 6.2.2.2 Law No. 2: The Leader of the Kurdistan Liberation Movement

It was envisaged that the executive power in the Kurdistan region would be headed by the Leader of the Kurdistan Liberation Movement, elected according to Law No. 2. The Executive Leadership would consist of the Leader and the Council of

---

<sup>29</sup> Law No.1, Sec. 2, Art. 9.

<sup>30</sup> Law No.1, Sec. 2, Art. 10.

<sup>31</sup> Law No. 1, Sec. 1, Art. 6-7.



Ministers, formed according to Law No. 3. A presidential-style system was therefore planned by the IKF, with both the President and the assembly being elected, with the assembly appointing the Government Executive, but with the President possessing a veto.

The electoral principles and procedures for the election of the Leader of the Kurdistan Liberation Movement were identical to those of Law No. 1, with provisions made for a secret ballot, and for the two elections to be run at the same time. The main provisions of the position and requirements of candidature were as follows;

1. The term of the Leadership of the Kurdistan Liberation Movement is for 4 years (Article 2).
2. The candidates must be no less than 40 years old (Article 5.1).
3. He should be a citizen of Iraqi Kurdistan and live within its territory (Article 5.2).
4. The Kurdistan Liberation Movement represents and speaks on both internal issues and foreign affairs (Article 1).
5. The leader is the Commander for all Kurdish armed *peshmerga* units in Iraqi Kurdistan (Article 12).
6. The leader invites the KNA to hold ordinary and extraordinary sessions (Article 10.1).
7. The leader sanctions agreements validated and confirmed by the KNA (Article 10.2).
8. He enacts laws and regulations confirmed by the KNA (Article 10.3).
9. He issues decisions on laws and regulations decided upon during the recess of the KNA or in urgent circumstances. The decisions have to be presented to the KNA at the earliest opportunity (Article 10.4).
10. The leader proposes laws to the KNA (Article 10.5).
11. He announces the proceedings for the election of the KNA during a fifteen day period before the end of the final session.
12. He orders the establishment of the executive authority of the KRG through the KNA (Article 11.1).

13. He develops a general set of policies for the region with the executive authority (Article 11.5).
14. The leader may sanction the use of a death penalty, or choose to alleviate to a lesser sentence (Article 11.6).

Perhaps most importantly for the political dynamics of the future, Article 13 allowed for the Prime Minister to replace the Leader of the Kurdish Liberation Movement when absent from his duties, and Article 14 allowed for the Speaker of the KNA to replace the Leader temporarily if the position became unoccupied, until a new Leader could be elected within a period of 2 months.

### 6.2.2.3 The Laws of the IKF as de facto Constitution?

Constitutions are concerned primarily with the organization of governments and indicate the formal distribution of authority.<sup>32</sup> Differences in constitutions reflect differences in the approach to the embodiment of political principles such as 'power to the people', 'popular sovereignty' and 'federalism'.<sup>33</sup> Constitutions cover three main areas of governmental organization: the executive, the assembly (parliament), and decision-making structures. Their provisions specify how the central decision-making body is to be organized, the structures and powers of the representative body, including the relationship with the executive (e.g. the distinction which differentiates between separation of powers systems and parliamentary systems), and the extent to which public decisions are taken at different levels, and therefore the apparent level of decentralization.

As we have seen, prominent Kurdish politicians in the KDP and PUK were not keen to identify the laws of the IKF as constitutional; as it would imply that their aim was to establish an independent Kurdish state. However, it is possible that these laws may be considered the basis of a *de facto* constitution. Constitutions aim at organizing the operation of governments, however, some countries do not have a document identifiable as 'The Constitution', but instead have a set of conventions, customs, rules and statutes which shape the organization of the government. There is no single written constitution in the United Kingdom for example, but there are many statutes

---

<sup>32</sup> Duchacek (1973) *Power Maps: The Comparative Politics of Constitutions*. Santa Barbara, Calif.: ABC Clio; Hague, et. al. (1998) *op. cit.*, p. 262.



which display constitutional character as they organize governmental institutions.<sup>34</sup> To some extent, the constitution may relate to the actual organization of the polity, and simply be a description of the structure and operating procedures of existing institutions.

With regard to such references, Colin Turpin suggests a definition of the Constitution of the United Kingdom which may have be useful to apply to the Laws of the IKF: “[the Constitution is] *a body of rules, conventions and practices which describe, regulate or qualify the organization and operation of government in the United Kingdom.*”<sup>35</sup>

Nouri Talabany, a constitutional lawyer, supports the notion that the laws of the IKF may be identified as having constitutional functions:

“... any government that does not come to power through election by the people is not a legitimate government. The exercise of power is determined by legal principles set down by peoples' representatives and thus the constitution is considered which as the highest legal standard, supersedes all laws. . . . The people of Iraqi Kurdistan, too, have a right to govern themselves through a legitimate, elected body. They were exercising this right when, on May 19 1992, they elected their first Regional Parliament in a free atmosphere. . . .”<sup>36</sup>

Therefore, in identifying the constitution, it is not necessary that a document named ‘The Constitution’ should exist. In studying the *de facto* state, it appears that the tenets of the Laws of the IKF could be seen to exhibit considerable constitutional-type powers and authorities, and the subsequent Laws of the KNA have gone even further in their intentions to organize the structure of authority and decision-making responsibilities within the *de facto* state. However, in order to preserve their delicate situation, Kurdish politicians refuse to name any of the Laws as fully constitutional. Perhaps a satisfactory solution would be to identify the laws as a *de facto* constitution for the *de facto* state.<sup>37</sup>

---

<sup>33</sup> Blondel (1995) *op. cit.*, p. 225.

<sup>34</sup> Turpin (1990) *British Government and the Constitution: Texts, Cases and Materials*. London: Weidenfeld and Nicolson, p. 3.

<sup>35</sup> *Ibid.*

<sup>36</sup> Talabany (1999a) *op. cit.*, p. 1.

<sup>37</sup> It is interesting to note that Nouri Talabany prepared a draft constitution which was adopted by the Electoral Committee of Kurdish jurists in 1992. The draft was then presented to the KNA on 4 October 1992, when 1/3 of the assembly presented their support to the Speaker in written form. The

### 6.2.3 The Elections

Elections took place according to Law No. 1 on 19 May 1992, under the observation of human rights organisations, MPs from other states and foreign journalists.<sup>38</sup> An immediate problem faced by the Electoral Supervising Committee was how to plan the election in the absence of a regional census. The IKF originally estimated a figure of 1.1 million eligible voters but, as a consequence of the demographic upheavals caused by the catastrophic events of the 1980s, the existing electoral registers of the GOI were of little use.<sup>39</sup> However, the figure of 1.1 million remained and Iraqi Kurdistan was divided into four electoral districts, forming the basis of the geographical organization of the election.

#### 6.2.3.1 Analysis of Results

The election was one of the most democratic to be held in the Middle East, with an unprecedented number of people voting. Hoff, *et. al.*, stated that “*practically the entire electorate, both men and women turned up,*” with IKF spokesmen estimating that 90% of the electorate had actually voted. Independent observers present during the elections wrote that “*the turnout was an unambiguous sign of the population's awareness of the importance of democratic principles, and of protest against Saddam's regime.*”<sup>40</sup>

##### 6.2.3.1.1 The KNA Results

For both elections of the KNA and the leader of the Kurdistan Liberation Movement, the polling process commenced at 8 am with the finishing time extended from 8 pm to 12 am due to the large turnout. However, the results, announced on 22 May 1992, have proved to be a constant source of confusion. In the election of the KNA, the KDP secured a marginal victory, which they claimed would have given them 51 seats out of 105.<sup>41</sup> However, figures from the PUK taken from the same period claim that the true result, while giving a marginal victory to the KDP, resulted in an equitable

---

draft constitution includes many aspects of the Laws of the IKF, and places them in a framework of federalism within the Iraqi state. Talabany (1999a) *op. cit.*

<sup>38</sup> Voice of Rebellious Iraq, Salahadin, 23 January 1992 (SWB ME/1288). The sources employed in this section include interviews with politicians from the period, documents provided by the KDP and PUK, and the comprehensive article by Hoff, *et. al.* (1992) *op. cit.*

<sup>39</sup> *Ibid*, p. 9.

<sup>40</sup> *Ibid*, p. 11.

<sup>41</sup> Interview with Muhsin Dizayi, Salahadin, 30 May 2000.



division of seats.<sup>42</sup> Appendix IV presents the figures range of results presented by the KDP and PUK.

Irrespective of the results, the outcome would be decided by force. Sources in Kurdistan indicate that the PUK was following a militant line and would fight rather than become an opposition party in the new assembly.<sup>43</sup> The final result was the sharing of the seats equally between the PUK and KDP, with the Christian parties receiving their guaranteed five seats.<sup>44</sup>

**Table 6.2: The Competing Parties of the May 1992 Elections**

<b>List No.</b>	<b>Party Name</b>	<b>Acronym</b>
1.	Kurdistan Democratic Party	KDP
2.	Kurdish Socialist Party (inc. Kurdistan Socialist Party)	PASOK
3.	Kurdistan Popular Democratic Party	KPDP
4.	Iraqi Communist Party	ICP
5.	Islamic Movement of Kurdistan	IMK
6.	Independents	---
7.	Patriotic Union of Kurdistan (inc. Kurdistan Toilers Party)	PUK
<b>Christian Lists</b>		
8.	Assyrian Democratic Movement	ADM
9.	Kurdistan Christian Unity (pro-KDP)	KCU
10.	Democratic Christians (pro-PUK)	DC
11.	Kaldo-Ashur Democratic Party (pro-ICP)	KAD

<sup>42</sup> PUK Foreign Relations Bureau, Suleimaniyah, document provided on 28 August 1999, entitled *The Result of Distributing the Seats in the National Assembly of Kurdistan*. It is indicated on the document that the results were produced by the University of Salahadin, presumably at the time of the election.

<sup>43</sup> Interview with Massoud Barzani, Saryrash, 22 August 1999.

<sup>44</sup> See Appendix 4 for list of the KNA members of 1992.

**Table 6.3: The Electoral Regions of the 1992 Election**<sup>45</sup>

<b>Electoral Region</b>	<b>Polling Stations</b>
Erbil Governorate	64
Dohuk Governorate	56
Suleimaniyah Governorate	42
Darbandikhan Governorate	16
<b>Total</b>	<b>178</b>

#### 6.2.3.1.2 *The Leadership Results*

The election for leader of the Kurdistan Liberation Movement took place on the same day as the elections to the KNA. The candidates for the position were Massoud Barzani of the KDP, Jalal Talabani of the PUK, Sheikh Othman Abdul-Aziz of the IMK, and Dr Mahmoud Othman of the KSP.

**Table 6.4: Votes and Percentages for the Leadership Election**<sup>46</sup>

<i>The Candidate</i>	<i>Votes Cast</i>	<i>Percentage</i>
Massoud Barzani (KDP)	466,819	47.51
Jalal Talabani (PUK)	441,507	44.93
Othman Abdul-Aziz (IMK)	38,965	3.97
Mahmoud Othman (KSP)	23,309	2.37
<b>Total</b>	<b>970,600</b>	<b>100</b>

Again, the results have again been a cause for much debate. Barzani and Talabani dominated the ballot, as their respective parties did in the KNA elections, but neither was capable of securing an absolute majority.

<sup>45</sup> *Ibid*, p. 10.



### 6.2.4 Conclusion

The results being so evenly divided between the two main parties and the two main candidates for leader presented the political system with a difficult problem. Law No. 2 allowed for such an outcome by providing for a further election to take place fifteen days after the first round. However, Massoud and Talabani agreed to stay out of the official organs of governance after the first round and this arrangement was retained for the next two years.<sup>47</sup> This effective isolation of the two pre-eminent political leaders from the fledgling administrative structure, combined with the equal division of power in the KNA and, subsequently, the KRG would result in the increasing politicization of the governmental system and the migration of the decision-making process into the political bureaux of the KDP and PUK.

### 6.3 The Morphology and Prescribed Operating Procedures of the KNA

The KNA held its inaugural session on 4 June 1992 in the parliamentary buildings of Erbil.<sup>48</sup> The duration of the KNA was to be three years (ordinary sessions), unless an extraordinary state of affairs became predominant in the region and then extraordinary sessions would be held.<sup>49</sup> It was prescribed that the KNA would have two sessions a year, with the first session commencing in March and culminating in June, and the second sitting from September to December.<sup>50</sup>

#### 6.3.1 The Morphology of the KNA

Figure 6.1 illustrates the morphological design of the KNA. The KNA is still in existence, albeit in a modified state. The following description focuses on the legal requirements for the KNA, rather than on what currently exists which will be developed at a later point. The assembly has a full membership of 105 MPs (although this was halved after the invasion of Erbil in 1996) of whom 99 were male, and 6 female. The distribution of MPs by governorate were as follows: Dohuk - 20.2%; Erbil - 30%; Suleimaniyah - 34.3%; New Kirkuk - 15.2%.

---

<sup>46</sup> Hoff, *et. al.* (1992) *op. cit.*, p. 14. Of the 982,649 votes cast, 12,079 votes were deemed void and/or unreadable.

<sup>47</sup> Natali (1999) *op. cit.*, pp. 9-11.

<sup>48</sup> Kurdistan Democratic Party (1994) *op. cit.*, p. 5.

<sup>49</sup> Kurdistan National Assembly (1994) *op. cit.* An extraordinary session of the KNA was held on 27 May 1995 in Daraban village where it was agreed that the duration of the KNA would be extended from 4 June 1995 to 4 June 1996. (Iraqi Kurdistan National Assembly Proceedings, Vol. 13, 1997).

<sup>50</sup> Kurdistan National Assembly (1998) *op. cit.*, p. 29.

**Figure 6.1: Kurdistan National Assembly (KNA) Morphology**

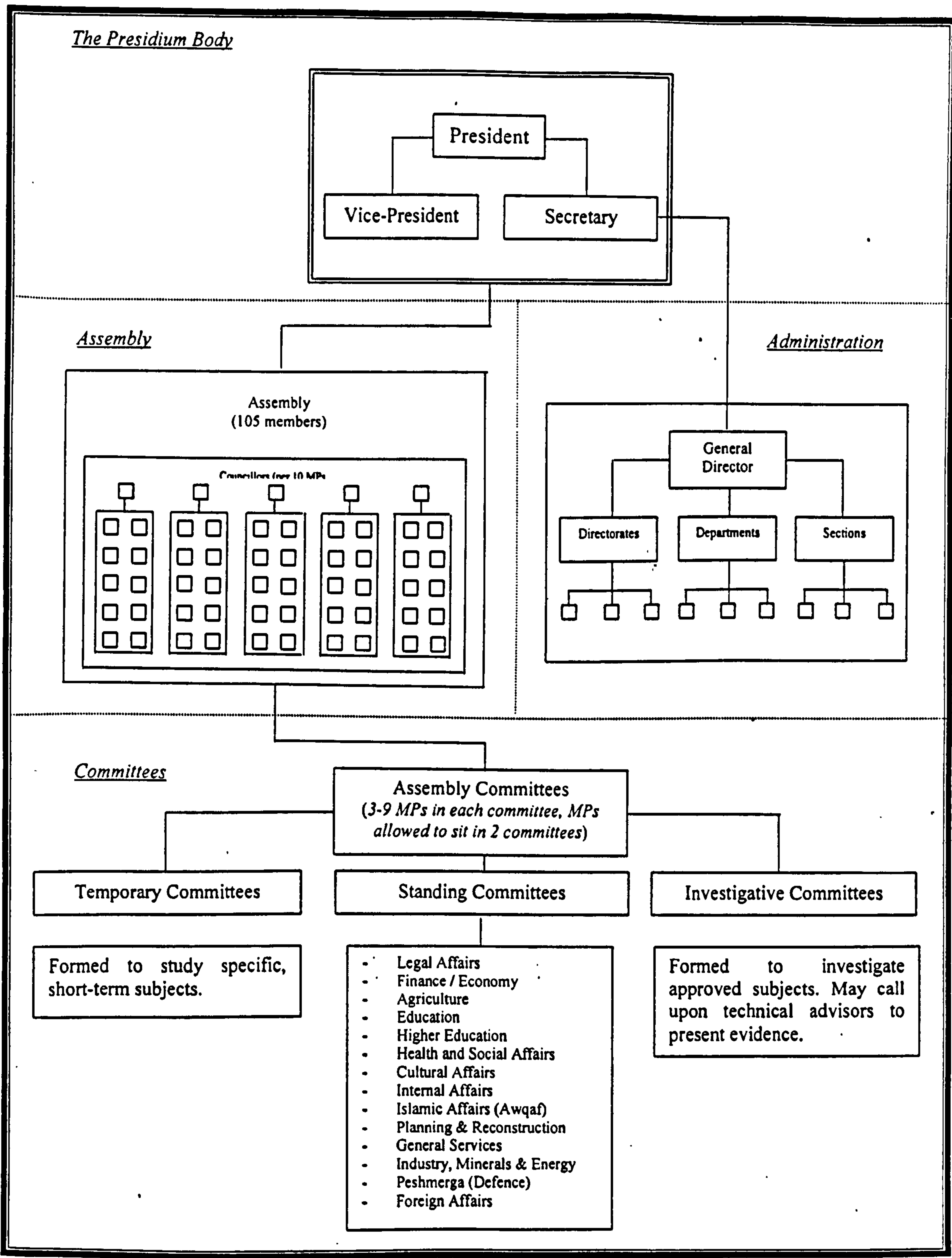



As expected, Dohuk was the electoral stronghold of the KDP, and Suleimaniyah of the PUK with Erbil in the middle, politically as well as geographically.<sup>51</sup>

The KNA is unicameral in structure, which is a remnant of the previous provincial assembly of the GOI, and also a reflection of the need for simplicity due to the time constraints imposed upon the IKF. Tribal leaders were actively promoting the idea of forming an advisory committee, effectively acting as a second, higher, chamber. However, such initiatives were rejected.<sup>52</sup> For each ten MPs there exists a Parliamentary Councillor. The task appointed to this position is to forward proposals to the Presidium of the KNA for further discussion. Similarly, for a proposal to be forwarded, it is necessary that it is supported by no less than 10 MPs.

#### 6.3.1.1 Principles and Procedures

The duties of the KNA, as defined by KNA protocol and interviews with members of the KNA, are as follows:<sup>53</sup>

1. To legislate laws.
2. To decide and debate the critical issues facing the Iraqi Kurdish people, and determine the legal relationship with the GOI.
3. To name the Prime Minister.
4. To support or criticise ministerial offices.
5. To determine development strategies for the population.
6. To supervise the activities of the executive offices.
7. To form investigation and over-sight committees when required.
8. To establish an internal system of administration, determine its possessions and appoint staff to offices.
9. To form permanent and interim committees to regulate the internal system.
10. To keep records of indictments and try civil servants who breach the oath of honour.

---

<sup>51</sup> Kakai (1992) *op. cit.*, p. 122.

<sup>52</sup> Natali (1999) *op. cit.*, p. 35.

<sup>53</sup> Kurdistan National Assembly (1994) *op. cit.*, p. 33; interviews with Mohammad Tawfiq, Suleimaniyah, 14 May 1998; Jawher Namiq Salim, Erbil, 8 September 1999.

### 6.3.1.2 Offices and MPs

The KNA is headed by a Presidium body composed of the Speaker, the Vice-President, and the Secretary. All positions are elected by the KNA at the first session. Both the KDP and PUK were in agreement in the appointment of the Speaker and Vice-President, with Jawher Namiq Salim of the KDP Political Bureau becoming Speaker and Mohammad Tawfiq of the PUK Political Bureau becoming Vice-President (later to be replaced by Nazad Aziz Agha of the same party).<sup>54</sup> As to be expected, these decisions were reached by the political bureaux of the two main parties and then forwarded to the KNA for ratification. However, while this suggests that two political systems were developing, each with separate political elites and decision-making bodies, the subsequent disagreement over the position of Secretary of the KNA illustrates the democratic thinking which the Kurdish political parties were following at this time. The KDP nominated Firsat Ahmed to the position, against the PUK nominee Ayad Namiq. The KDP nominee won after a secret ballot of the MPs.<sup>55</sup>

The duties of the Presidium are straightforward and involve the organization and daily activities of the KNA. They are as follows:<sup>56</sup>

1. To form an agenda for each session.
2. To settle points of dispute between and among committees.
3. To apply the rules formulated by KNA sessions.
4. To certify the minutes of the sessions.
5. To propose the establishment of Investigative Committees.
6. To form Investigative Committees during the recesses.

### 6.3.1.3 Committees of the Assembly

Kayshap observes that '*an assembly is known by the committees it keeps*', and the KNA is no exception.<sup>57</sup> The KNA has two main types of committees – permanent

<sup>54</sup> Jawher Namiq would remain in this position until the re-shuffle of the Erbil administration by the KDP Twelfth Congress in October 1999.

<sup>55</sup> Kurdistan National Assembly (1994) *op. cit.*

<sup>56</sup> *Ibid*, p. 33; interview with Jawher Namiq Salim, Erbil, 8 September 1999; Mohammad Tawfiq, Suleimaniyah, 7 August 1999.

<sup>57</sup> Kayshap (1979) "Committees in the Indian Lok Sabha," in Lees and Shaw (eds.) *Committees in Legislatures: A Comparative Perspective*. Durham, NC: Duke University Press, p. 321, quoted in Hague, *et. al.* (1998) *op. cit.*, p. 289.



and temporary, with both being known as investigative committees. The permanent committees, formed at the first session of the assembly, duplicate ministerial portfolios and effectively act as watchdogs over ministerial activities. Temporary committees address extraordinary problems which are of a more limited duration such as the drought of 1999. MPs are allowed to be in no more than 2 permanent committees, with restrictions being relaxed for temporary committees.

The committees themselves have to contain between 3 and 9 MPs and are formed by majority agreement.<sup>58</sup> They can also be formed by the Presidium alone when the assembly is in recess. The Presidium has the right to call any technical or expert advisor to present evidence to the committees.

**Figure 6.2: The Formation of Committees of the KNA**<sup>59</sup>

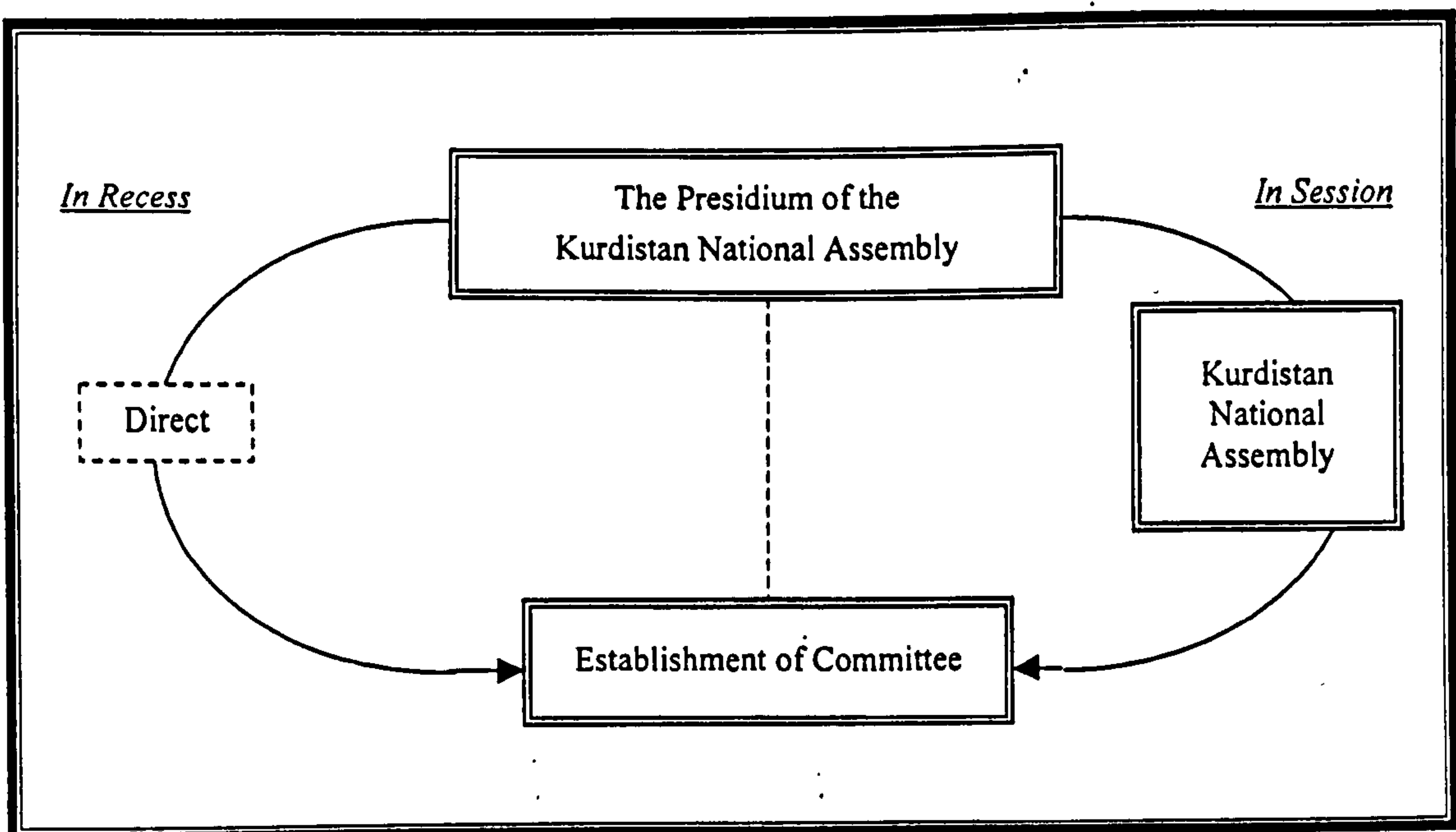

### 6.3.2 The Legislative Process

Figures 6.3 and 6.4 illustrate the legislative process which is the prescribed practice of the KNA. Laws and regulations are proposed to the KNA from two main sources: Parliamentary Councillors and the Council of Ministers. Councillors have the right to propose laws and resolutions to the Presidium which represent the opinion of ten or

<sup>58</sup> Kurdistan National Assembly (1994) *op. cit.*, pp. 29-31; interview with Jawher Namiq Salim, Erbil, 24 August 1998.

more MPs. The Council of Ministers may propose motions to the KNA, and then the proposals are entered into the KNA agenda.

6.3.2.1 *The Passing of Laws*

Drafts of agreed motions are sent to the Permanent Legal Affairs Committee and the specialist technical committee relevant to the proposal. It is then distributed to the assembly by means of the leaders of the Parliamentary blocks. The proposal and

**Figure 6.3: Schematic Representation of the Proposal of Laws and Regulations<sup>60</sup>**

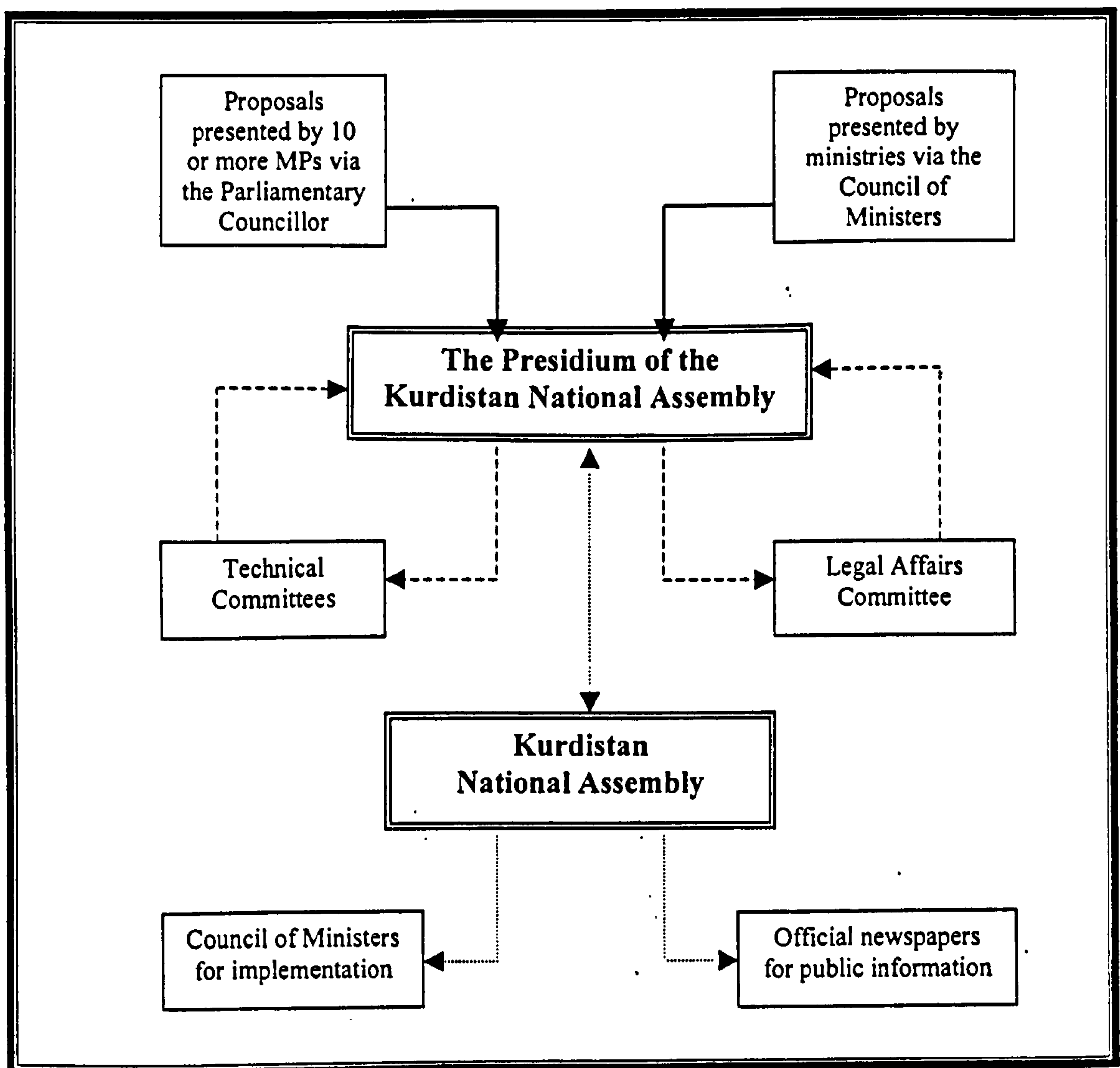

comments are then returned to the Presidium by the assessing committees and redistributed again. The draft is then entered into the agenda of the assembly for

<sup>59</sup> *Ibid.*



discussion by all members. The second route available for the passing of laws is by the Council of Ministers which has authority to present proposals to the KNA. A similar system of commentary is employed and the confirmation of a proposal requires a majority vote in the KNA, unless there is a call for a special majority.

#### 6.3.2.1.1 *Parliamentary Questions*

Any MP is allowed to ask questions from the floor to the Speaker and/or Council of Ministers representatives about subjects of interest to themselves and/or the findings of Committees. Figure 6.4 illustrates the questioning and answering process of the KNA:

**Figure 6.4: Questioning and Answering in the KNA**<sup>61</sup>

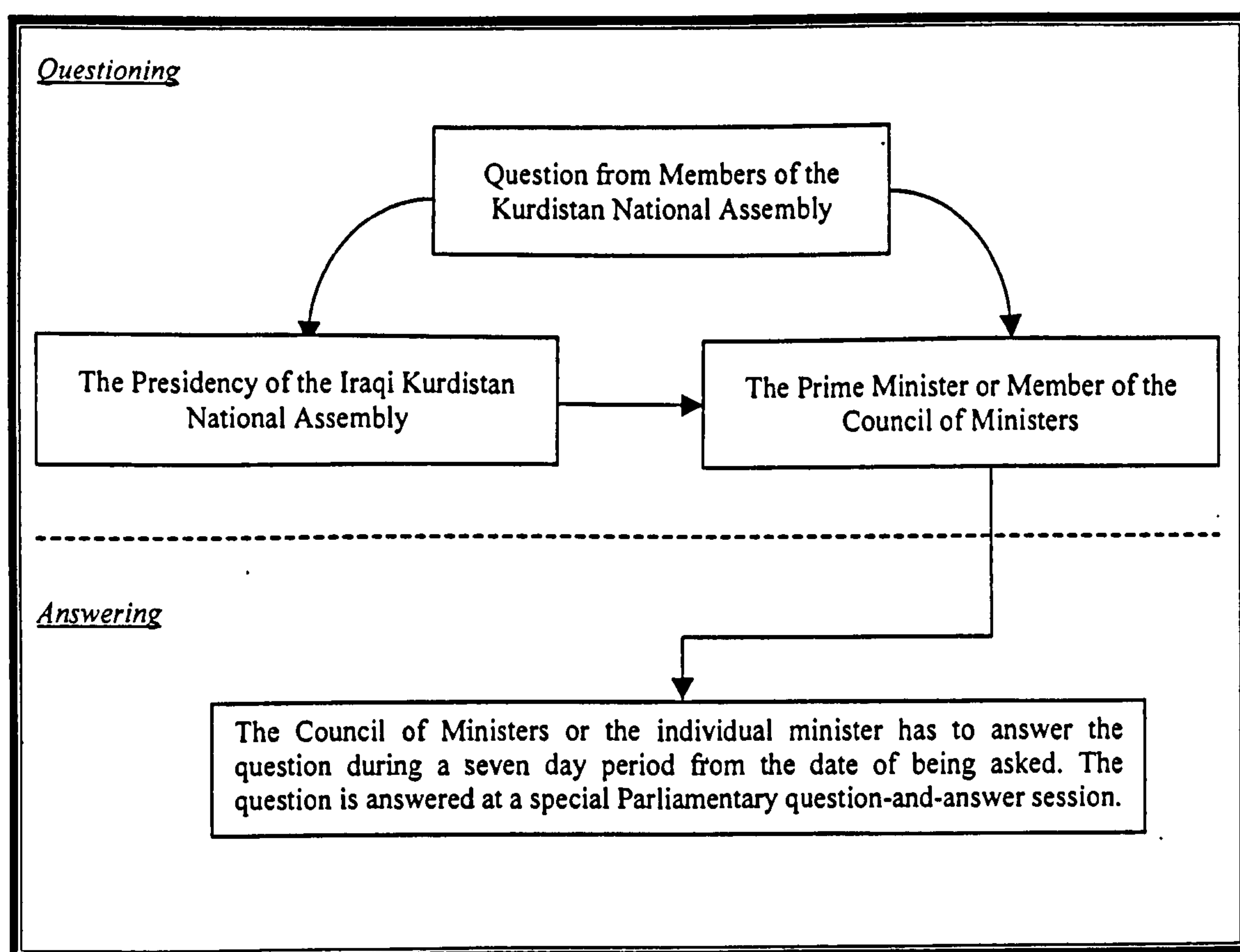

<sup>60</sup> *Ibid*, p. 40; interview with Jawher Namiq Salim, Erbil, 8 September 1999.

<sup>61</sup> Source: Kurdistan National Assembly (1994) *op. cit.*, p. 40; interview with Jawher Namiq Salim, Erbil, 8 September 1999.

### 6.3.3 Conclusion

Until August 1996, the KNA held 193 ordinary sessions and 15 extraordinary sessions. 140 laws and resolutions were promulgated and the Assembly had a key role in establishing a cease-fire between the KDP and PUK during the internal fighting of May-June 1994. While ultimately failing to achieve a comprehensive cease-fire between the KDP and PUK, the KNA demonstrated that it was an institution of considerable influence and power even in the most troubled of times. The verve with which the legislature was addressed by the newly elected MPs resulted in a plethora of legislation establishing the executive offices, regularising the judiciary, and attempting to bring some normality to the region. As a legislature, the KNA seemed to thrive on a divided political system, which enhanced the negotiating powers of participant parties and was a useful non-combative arena in which party politics could be played out. Dr Fu'ad Massoum noted that "*even with these inherent problems [of internal fighting], the KNA did not suffer one day of verbal abuse between different members or groupings, even at times of tension.*"<sup>62</sup> For these reasons, as an institution, it is difficult to argue that the KNA should be anything but unified and, as such can only strengthen the political system of Iraqi Kurdistan.

### 6.4 The Morphology and Prescribed Operating Procedures of the Executive Offices of the KRG

The first cabinet was formed on 4 July 1992 according to Law No. 3 of 1992. The number of participant ministers in the cabinet was 15 besides the Prime Minister and Deputy Prime Minister. Only parties who competed in the 1992 election contributed to the cabinet as most non-participant parties were established after the election. The major ministries were divided between the two main Parliamentary Blocks of the KDP and PUK. The KCP was granted the Ministry of Health and Social Affairs and the Toilers' Party, as it was in coalition with the PUK in the KNA, was granted the Ministry of Agriculture and Irrigation. The ADM was granted the Ministry of Public Works and Housing.

Existing alongside the newly formed executive structure of the KRG was the local executive structure of the governorates. As the highest official organ of the GOI

---

<sup>62</sup> Interview with Dr. Fuad Massoum, London, 21 June 1999.



within Iraqi Kurdistan, the office of the Governor held an unusual amount of power and influence in the region.<sup>63</sup> However, instead of vowing allegiance to the GOI, the governors of the newly formed *de facto* state were KDP or PUK appointees, depending upon which party was dominant in a particular governorate.

In this section, I address both the ministerial executive structure of Iraqi Kurdistan, and the local executive structure as in an attempt to illustrate the overlapping authorities and linkage between the two systems, and the impact that individual characters can have on the workings of a political system.

#### 6.4.1 The Morphology and Prescribed Planning Process of the Regional Executive

Upon passing Law No. 3 of 1992 which established the executive authority of the KRG, the KNA undertook an extensive programme of establishing the constituent ministries and mandates.<sup>64</sup> The ministries, and their mandates, were based upon the previous GOI administration for the northern governorates, and simply upgraded, so that the previous General Directorate for Health in the Northern Governorates now became the Ministry of Health of the Iraqi Kurdistan region. However, the division between Iraqi Kurdistan and the central government, and problems peculiar to the north, forced the formation of four new ministries, namely: Humanitarian Aid & Cooperation (to liaise with the rapidly growing international NGO and UN presence); Reconstruction & Development (to address the redevelopment of the devastated rural areas); *Peshmerga* Affairs (to coordinate the joint *peshmerga* forces), and; Culture.<sup>65</sup>

##### 6.4.1.1 Cabinet Composition

The cabinet is composed of the Prime Minister, the Deputy Prime Minister, all ministers with portfolios, and 5 ministers of state. The cabinet holds regular meetings every Wednesday, commencing at 11 am. The Council Bureau (the Prime Minister

---

<sup>63</sup> Even when compared to the rest of Iraq, the Governors of Iraqi Kurdistan have always been characterised as enjoying enhanced executive authority due to the central administration relying heavily on the governor for the maintenance of security in the Kurdish regions. Interview with Sami Abdul Rahman, Salahadin, 3 April 1998.

<sup>64</sup> See Appendix 5 for a complete set of organograms illustrating the morphology of each ministry.

<sup>65</sup> The Ministry of Humanitarian Affairs and Cooperation is effectively a thinly disguised Ministry of Foreign Affairs. However, due to the status of the administration of the *de facto* state and lack of international recognition of its legitimacy, the Public Relations Office of the KDP and the Foreign Relations Bureau of the PUK handle the foreign affairs of the KRG. Interviews with Sa'adi Pira, Suleimaniyah, 17 April 1998; Dr Shafiq Qazzaz, Erbil 18 May 1998.

and his offices, in consultation with Ministers' bureaux) prepares an agenda to structure the meetings. According to KNA protocol regarding the executive process, the naming of the Prime Minister and Deputy Prime Minister is made by the KNA,

**Table 6.5: Ministry Establishing Laws of the KNA**<sup>66</sup>

<i>Ministry</i>	<i>Law</i>	<i>Year</i>
The Cabinet	3	1992
Education	4	1992
<i>Peshmerga</i> Affairs	5	1992
Interior	9	1992
Culture	11	1992
Justice	12	1992
Finance & Economic Affairs	13	1992
Municipalities & Tourism	15	1992
Health & Social Affairs	1	1993
Transport & Communications	2	1993
Power & Industry	5	1993
Awqaf & Islamic Affairs	7	1993
Agriculture & Irrigation	10	1993
Reconstruction & Development	11	1993
Public Works & Housing	13	1993
Humanitarian Aid & Cooperation	20	1993

after consultation with the Parliamentary Blocks. The KNA has the authority to support or withdraw its confidence in the Council of Ministers, effectively resulting in its dissolution.

#### 6.4.1.2 Cabinet Procedures

The agenda (which includes policy project proposals) is discussed in the cabinet, and decisions are a collective responsibility. The budget for ministerial programmes is

<sup>66</sup> Kurdistan National Assembly, Parliamentary Protocols; Voice of the People of Kurdistan, Salahadin, 26 April 1993 (SWB ME/1674); Voice of the People of Kurdistan, Salahadin, 21 December, 1993 (SWB ME/1880).



**Figure 6.5: Morphology of the Council of Ministers**

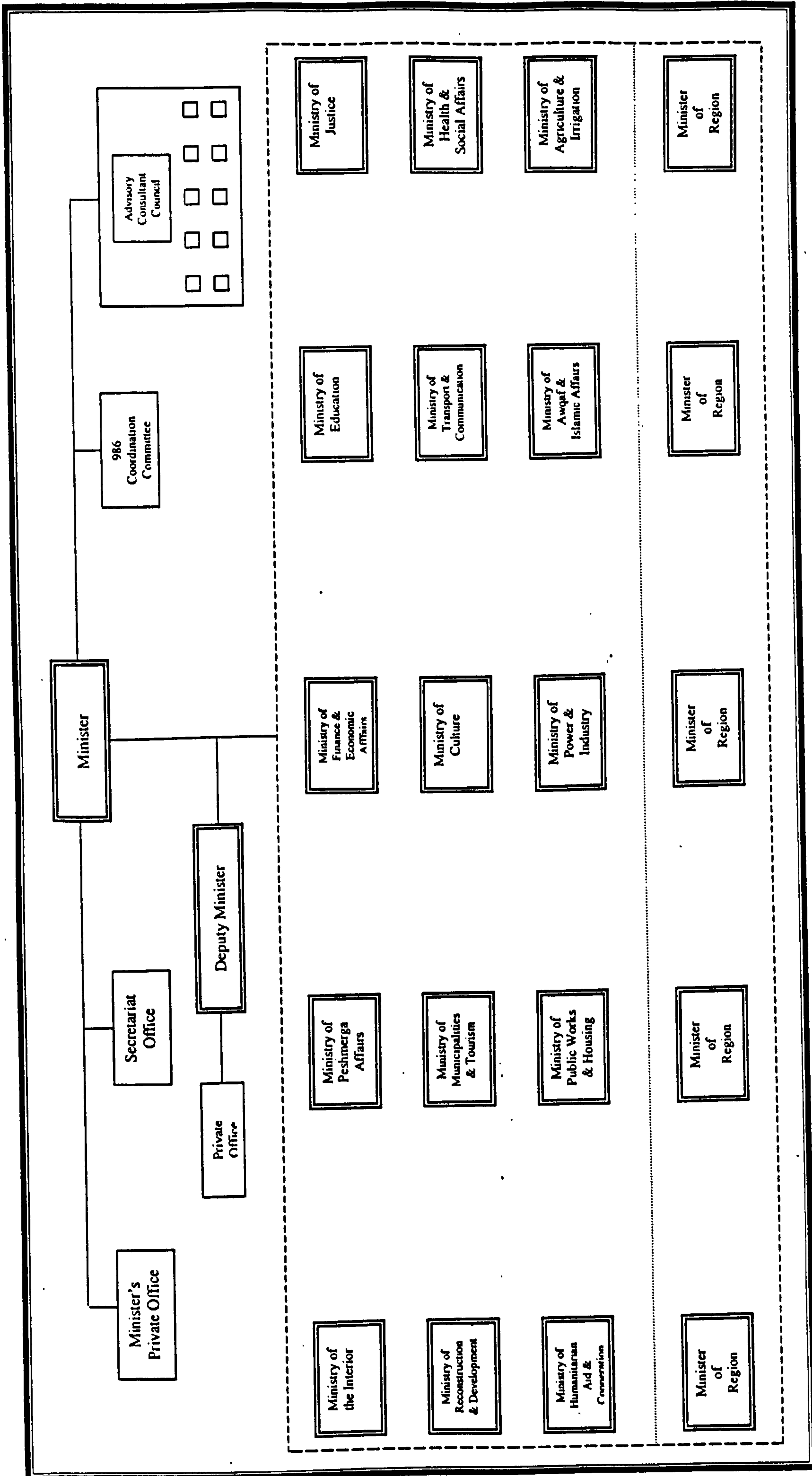

agreed in cabinet, with the approval of the Ministry of Finance and Economic Affairs. Proposals for new legislation is also prepared by the cabinet and forwarded to the KNA for acceptance and ratification.<sup>67</sup> It is the task of each ministry to develop an annual plan through the operations of its own bureaucracy which is then submitted to the Council of Ministers upon completion. Then, a specialist committee studies all the plans (normally technicians from the field in question). The proposals are then forwarded to the Cabinet with recommendations where it is then again discussed. It is finally forwarded with recommendations to the Ministry in question, along with an agreed budget.<sup>68</sup>

#### 6.4.2 The Executive Offices of the Governorates

Iraqi Kurdistan is divided into governorates which represent the highest level of executive power within a specified geographic area apart from that of the President and the Prime Minister.<sup>69</sup> The Governors are powerful individuals, appointed by the KDP or PUK, whose position is to be the representative of the President (or leader of movement) within his (there are no female governors) designated governorate.<sup>70</sup> This power structure is maintained in the division of the governorate, with the *Qaimaqamiyat* possessing the powers of the governor with his *Qaza*, and *Mudir al-Nahiya* possessing the same within his *Nahiya*.<sup>71</sup>

---

<sup>67</sup> Interviews with Sa'adi Pira, Suleimaniyah, 17 April 1998; Ahmed Sharif, Suleimaniyah, 13 May 1998; Dr. Shafiq Qazzaz, Erbil, 18 May 1998; Neechervan Barzani, Saryrash, 21 May 1998; Dr. Fu'ad Massoum, London, 2 June 1999; Raf'ad Abdullah, Suleimaniyah, 9 July 1998; Mohammad Tawfiq, Kalarcholan, 7 August 1999; Kosrat Rasoul, Suleimaniyah, 8 August 1999.

<sup>68</sup> Interviews with Ahmed Sharif, Suleimaniyah, 13 May 1998; Nechervan Barzani, Saryrash, 21 May 1998; Kosrat Rasoul, Suleimaniyah, 8 August 1998; Krekar Abdullah, Suleimaniyah, 10 July 1998; Raf'ad Abdullah, Suleimaniyah, 9 July 1998. Chalaw Ali Askari, Suleimaniyah, 13 May 1998; Sheikh Ma'amon Brifkani, Erbil, 20 May 1998; Abu Hikmat, Erbil, 9 May 1998; Bahman Hussein, Suleimaniyah, 11 July 1998; Dr Fu'ad Massoum, London, 2 June 1999; Badrea Osman, Erbil, 1 July 1998; Sa'adi Pira, Suleimaniyah, 17 April 1998; Shafiq Qazzaz, Erbil, 28 February 1998; Idris Hadi Saleh, Erbil, 19 May 1998; Sheikhallah Ibrahim Sheikhallah, Erbil, 1 July 1998.

<sup>69</sup> The governorate system in Iraq, including the designation of powers, was formalised in the 1969 Iraqi Governorate Law. The KNA has the authority, according to its own operating procedures to alter the tenets of the law, but did not do so during the first two cabinets. However, unconfirmed reports suggest that the KDP-dominated KNA in Erbil will promote the formation of two new governorates in the immediate future, possibly in the regions of Soran and Aqra. Interviews with Aso Sheikh Nuri, Suleimaniyah, 5 May 1998; Mahdi Khoshnaw, Erbil, 14 June 1998.

<sup>70</sup> Due to the present ambiguous situation surrounding the election of the Leader (President) of the Iraqi Kurdistan region, the governors are official appointed by the Prime Minister, to whom the appointed persons have to swear an oath. Interview with Aso Sheikh Nuri, Suleimaniyah, 5 May 1998.

<sup>71</sup> See Chapter 4 for a description of the governorate structure of Iraqi Kurdistan. The structure of the governorates in Iraq was established by Article 2 of the Iraq Governorate Law of 1969. Interviews with Mahdi Khoshnaw, Erbil, 14 April 1998; Aso Sheikh Nuri, Suleimaniyah, 5 May 1998.



While the system so far appears to be structurally straightforward, with corollaries in Iraq proper and the Middle East in general, it is apparent that, at times, there has been a significant amount of confusion caused due to the official legality of the position of the governor compared to the *de facto* legality of that of a Minister of the KRG. This division has been compounded by the fact that the governors, as the executors of activities within the governorate, control and oversee the activities of all general directorates, whereas the Kurdish system implemented since 1992 quite clearly places the general directorates, in a technical sense, beneath the ministerial structure. The following section investigates the structure of the governorate and its role in the administration of Iraqi Kurdistan since 1991.

#### 6.4.2.1 Principles and Procedures of the Governorate Executive Process

According to the Deputy Governor of Suleimaniyah, Aso Sheikh Nuri, the clearest way of describing the role of the governorate structure is that it is responsible for the administration of the governorate, overseeing the implementation of programmes and policies promulgated by the ministerial structure. The primary areas of concern for the governor include all public services and the protection of public property.<sup>72</sup>

In achieving these roles, the governor relies on two important relations, one to the Ministry of the Interior to which he is administratively subservient, and the other to the sectoral ministries whose directorates are tasked with implementing policies and programmes within the governorate.<sup>73</sup> The governor therefore possesses a considerable amount of authority over the activities of the directorates within the governorate, if not over the prescription of their activities which comes from the ministries. This level of control covers all general directorates and directorates of all ministries, apart from those directorates of the Ministry of Justice and the organs of the judicial system. Similarly, the governor has no authority over the universities or military forces.

In general, directorates and general directorates receive their instructions from the ministry concerned, and a copy of these instructions must be sent to the governor. The role of the governorate structure is then to order and monitor the activities

---

<sup>72</sup> Interview with Aso Sheikh Nuri, Suleimaniyah, 5 May 1998.

detailed in the instructions and report on the activity of the lower executive organs to the ministry concerned, and the Ministry of the Interior.<sup>74</sup>

The ministries also employ the infrastructure of the governorate and hand over some administrative rights to the governor. The governor then is free to establish committees which work in conjunction with the ministries providing public services within the governorate, effectively creating a miniature government for the governorate.<sup>75</sup> For example, in Suleimaniyah, the governor is the chairman of several committees, including the Suleimaniyah Security Committee, the Agriculture Committee, and the Education Committee. The committees have branches in the qaza and nahiyas, with the head of the area as the chairman. These committees submit reports to the Ministry of the Interior, and have the power to submit directives, requests and advice to individual ministries concerning policies within the governorate.

#### 6.4.3 Conclusion

The governorate represents more than the title would suggest, and the Prime Minister of the first cabinet, Dr Fu'ad Massoum, acknowledged that governors had created problems on several occasions.<sup>76</sup> In a position which essentially requires a technocrat to follow the sectoral activities of the executive, the appointees of the KDP and PUK were politicians and members of either the KDP Central Committee or the PUK Leadership Office.<sup>77</sup> This resulted in the governor possessing at least the same degree of political power as ministers, if not more, particularly as the governorate system had been operational since 1969, and the KRG only since 1992, enhancing the legitimacy of the governor.<sup>78</sup> Sami Abdul Rahman highlighted some of the situations this has led to, with governors exercising their considerable political power:

---

<sup>73</sup> Interview with Fadhil Merani, Erbil, 26 August 1999.

<sup>74</sup> Mahdi Khoshnaw, the Deputy Governor of Erbil, explained the system with reference to the implementation of education policies in Erbil. The Ministry of Education is responsible for fixing the dates of exams and forming a regional curriculum, while the Governorate of Erbil is responsible for implementing and supervising these orders. Interview with Mahdi Khoshnaw, Erbil, 14 June 1998.

<sup>75</sup> Interview with Dr Shafiq Qazzaz, Erbil 18 May 1998.

<sup>76</sup> Interview with Dr Fuad Massoum, London, 21 June 1999.

<sup>77</sup> The Governor of Dohuk until 1999 was Abdel Aziz Tayyib (KDP Central Committee); Erbil, Franso Hariri (KDP Central Committee); Suleimaniyah, Hackam Khadr Hama Jan (PUK Leadership Office); Kirkuk, Jalal Jawher (PUK Leadership Office).

<sup>78</sup> Interviews with Gerhard Mortier, Erbil, 9 March 1998; Dr. Shafiq Qazzaz, Erbil 18 May 1998.



“[In Erbil and Dohuk] *both governors are in the Central Committee. This is different to Iraq. In Iraq, the regime places technocrats in such positions who are not willing to argue, politicians and peshmerga will argue more.*”<sup>79</sup>

There is a structural control in place in the fact that the immediate superior of the governor, the Minister of the Interior, is always a member of the Political Bureau. However, it is apparent that the relative strength of the governors has been enhanced and supported by UN agencies. Caught in a minefield of legal prerequisites by the GOI, UN agencies have had to work primarily with the official organs of the GOI, including those in Iraqi Kurdistan.<sup>80</sup> As the GOI does not recognise the ministries of the KRG, the UN is forced to work directly with the governors which, at times has proved to be problematic both for the implementation of UN SCRs and the development of clear administrative structure within the *de facto* state.<sup>81</sup>

## 6.5 The Judiciary

With the withdrawal of the GOI in 1991 came the need for the IKF to establish a judicial system to restore law and order across the territory. Civilian police forces were reconstituted and placed under the control of the local committees of the IKF. Similarly, local courts and judicial institutions were reopened and operated through the organizational structures of the governorate.<sup>82</sup> Before an official legal system could be formed by the KNA, the police and courts of the region operated according to the Penal Code and Code of Criminal Procedure of Iraq, which, according to an Amnesty International report, fell short of international standards.<sup>83</sup> This was compounded by the fact that many aspects of these emergency procedures appeared to be more party orientated rather than independent, resulting in several reported cases of miscarriages of justice.<sup>84</sup>

---

<sup>79</sup> Interview with Sami Abdul Rahman, Salahadin, 3 April 1998.

<sup>80</sup> Interview with Dr Shafiq Qazzaz, Erbil 18 May 1998.

<sup>81</sup> Interviews with Gerhard Mortier, Erbil, 9 March 1998; Dr Shafiq Qazzaz, Erbil 18 May 1998. Gerhard Mortier, the UN Field Delegate for Erbil during 1998, believed the position of governor, particularly in Dohuk, to be noticeably more influential than the ministerial structures. Similarly, the position of Franso Hariri, the Governor of Erbil until 1999, was bolstered by him also being an MP, Minister of Region (without portfolio), and member of the KDP Central Committee.

<sup>82</sup> For details regarding this earlier period, see: Amnesty International (1995) *op. cit.*, p. 25.

<sup>83</sup> Penal Code, Law No. 111 of 1969; Code of Criminal Procedure, Law No. 23 of 1971. Amnesty International (1995) *op. cit.*, p. 25.

<sup>84</sup> *Ibid.*

### 6.5.1 Principles and Procedures

Law No. 44 of the 28 December 1992 established judicial power in the region, according to Law No. 14 of 1992.<sup>85</sup> The judiciary was designed to be an independent establishment of the KRG, independent from all other institutions, including political parties. The Kurds certainly had the expertise to design and implement such a system, with an extensive legal system previously operating in Iraq requiring the training and provision of significant numbers of legally trained personnel. Courts of the Judiciary were to sentence in the name of the people of Iraqi Kurdistan, and had authority over all persons, including those in positions of authority in the KRG. The design of the judicial system (and the organization of the courts), either civil or criminal, corresponded to the Iraqi system. Correspondingly, the courts apply the laws of Iraq in all cases. However, they retained the right, through the KNA, to nullify any Iraqi law issued before the date of the GOI withdrawal. The judicial system also retained the right to implement those laws issued by the KNA after this date, according to Law No. 11 of 31 August 1992.<sup>86</sup> The most important of the laws establishing the Judiciary was the Judicial Authority Law of December 1992.<sup>87</sup> This law affirmed the independence of the Judiciary and allowed for the establishment of a Supreme Court in Iraqi Kurdistan.

### 6.5.2 The Organization of the Judiciary

The highest court in Iraqi Kurdistan is the Supreme Court (Court of Cassation), which was originally designated to reside in Erbil and be responsible for reviewing the entire region. Beneath the Supreme Court there are two appeal districts based in Erbil and Suleimaniyah (previously Kirkuk).

The Supreme Court was perhaps the only aspect of the Judiciary which was created wholly by the Kurds after 1991. In order to operate under Iraqi law, the services of a Supreme Court were required, however, the only one which existed in Iraq was in Baghdad.<sup>88</sup> In addition to this, the hierarchy of courts in the region already existed within the previous Iraqi system and are as follows: 1. Court of Appeal; 2. Court of

---

<sup>85</sup> Voice of the People of Kurdistan, Salahadin, 27 November 1992 (SWB ME/1551).

<sup>86</sup> Interviews with Khadir Jabari, Erbil, 30 June 1998; Abdul Rahman Nurisi, Suleimaniyah, 19 July 1998.

<sup>87</sup> Law No. 14, December 1992. See Amnesty International (1995) *op. cit.*, p. 44.

<sup>88</sup> *Ibid.*



Figure 6.6: Morphology of the Iraqi Kurdistan Judiciary

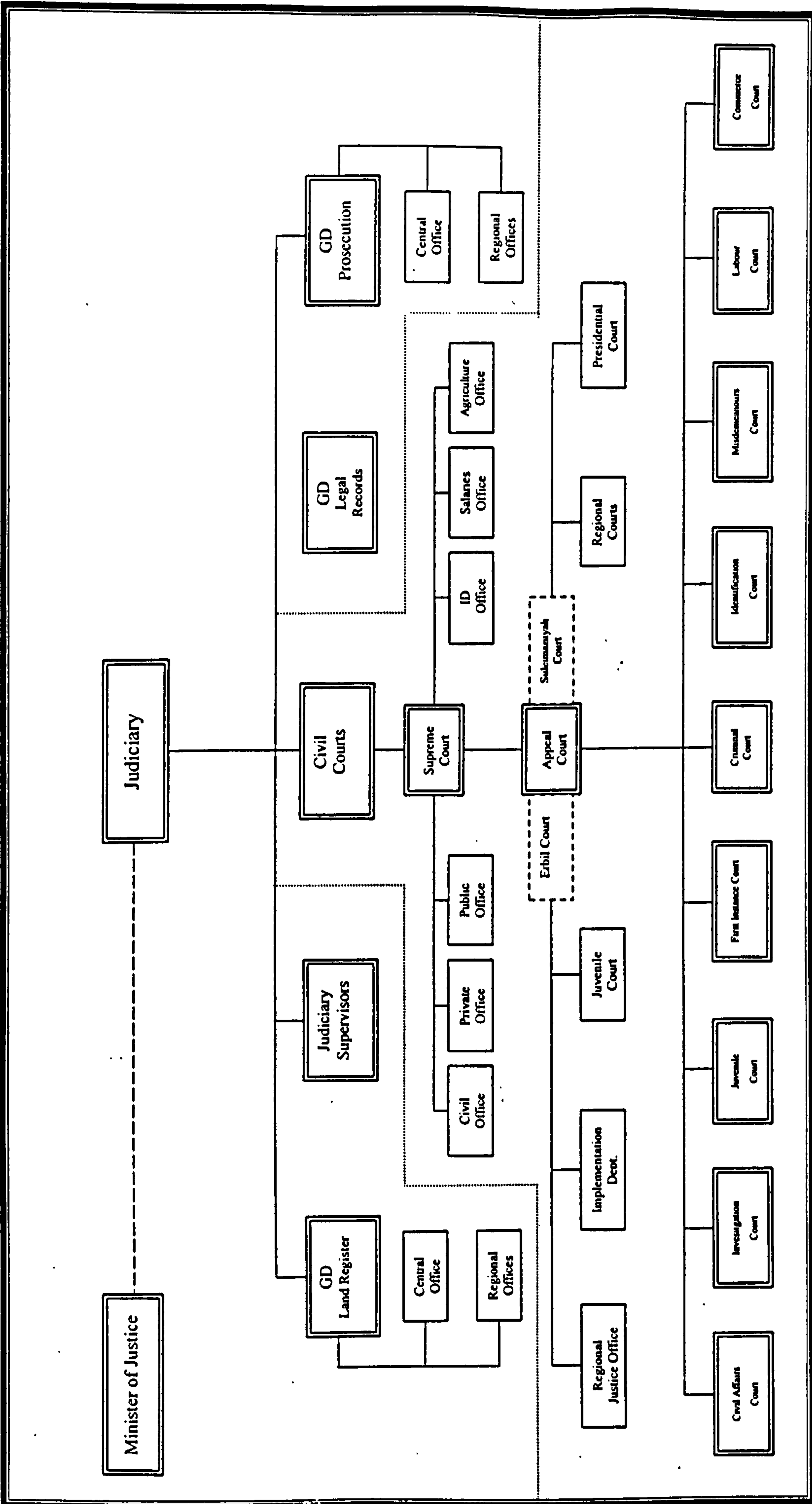

First Instance; 3. Personal Status Court; 4. Criminal Court (Court of Assizes); 5. Misdemeanours Court; 6. Court of Accidents; 7. Industrial Tribunal Court; and 8. Investigation Court.

### 6.5.3 Conclusion

The judicial system of Iraqi Kurdistan is perhaps the most difficult of the institutions of government to analyse. The description of the morphology and the analysis of its formation have been provided, but to assess the decision-making process beyond what it prescribed by the KNA is somewhat problematic. In such an area as Iraqi Kurdistan, which has suffered from severe problems of internal security in the early 1990s, and the input of political parties' interests into the operations of the judiciary, it is perhaps not to be expected that the activities of the judiciary are beyond reproach. Analyses provided by organizations such as Amnesty International indicate that, particularly in the earlier periods covered by the first and second cabinets, party political issues dominated the judicial process, particularly because the most dominant, antagonistic political entities were not only in the same geographical area together, but were also within the same organs of governance.

However, since 1996 and the separation of the parties, the party political rivalries have subsided considerably. The judicial system of Iraqi Kurdistan still has many problems, but, as Nawshirwan Mustafa opined, with regard to the levels of law and order in the streets of Suleimaniyah, when compared to neighbouring states, the levels of civilian security in Iraqi Kurdistan certainly may be judged in at least a comparable light. Of course, this does not allow one to hide the inadequacies of the current system. However, it is an indicator that, in the present political climate, the judicial system has been organised with the input of the previous national system, changes imposed by the KNA, and enforced changes caused by the changes which occurred in the political system of Iraqi Kurdistan in 1996. While still needing to progress considerably, there are signs that the political parties, the KRG, and the judiciary are attempting to promote legal as well as civil society in Iraqi Kurdistan.

## 6.6 Conclusion

The organizational structure and prescribed decision-making processes of the institutions of the KRG are extremely sophisticated, especially considering the



timeframe in which they have been developed. While it is a relatively easy task to identify flaws in the manner by which Kurds have been governing Iraqi Kurdistan for the last decade, the circumstances, in both political and economic terms, in which these institutions have been conceived and developed should not be overlooked.

This chapter has presented the bases for an in-depth analysis of the development of the KRG to take place. By employing a methodology grounded in comparative study of governance systems, it has been possible to place the institutions and processes of the Iraqi Kurdish governance system in some form of comparable perspective with other, perhaps more established systems.

This chapter has effectively established the skeleton of the administrative system, and the reasons and inputs for the initial formation and processes at the beginning of the 1990s. It has also presented aspects of defending the legality of the system, at least in a *de facto* sense. This now needs to be combined with an approach which identifies the way in which this system has operated over the last decade. The proceeding chapter attempts to provide such an analysis by addressing the different variables which have effected the system in the last decade, and by employing a methodology which allows the system to be studied at first hand.

## Chapter 7

### The Kurdistan Regional Government 1992-2000

#### 7.1 Introduction

In the political environment of Iraqi Kurdistan, the development of the KRG cannot be separated from the status of the relationship between the KDP and PUK, and the impact of the revenue generated by SCR 986. The KRG commenced the decade as a unified administration encompassing the two most dominant parties in a coalition executive and legislative, but suffered by being inextricably linked to the party political dynamic and by seriously lacking funds. It finished the decade divided geographically and politically between the cities of Erbil and Suleimaniyah, mirroring the division of the KDP and PUK respectively, with both administrations receiving SCR 986 revenue equivalent to the GDP of a small country.

Whilst this current division undoubtedly causes immense problems for the administration of the region, it has resulted in a system of government which is able to operate more effectively, if not more efficiently, than the previous 50-50 government. It is apparent that the initial system of coalition government adopted after the elections of 1992 promoted a system of governance dominated by two competing parties, effectively resulting in a moribund governmental process. The separating of these two unconciliatory political forces has promulgated the development of a divided system of government which, while being cumbersome and highly overstaffed, has proved to be a more successful system and one which has promoted political stability.

This chapter charts the development of the KRG throughout the 1990s and the characteristics of the operating procedures of the three separate cabinets of the period. The starting point is the formation of the KRG after the elections of 1992. The first attempt at power-sharing in a traditional consociational manner (the 50-50 system) is analysed, as are the reasons for its ultimate failure and subsequent decline into conflict. The geographically-divided political system which has existed from 1996 until the present is again analysed, and reasons for the increased stability which



has been apparent particularly since 1997 are identified. It is argued that this system is a geographic variant of a consociational political system and, whilst being unsuitable as a long-term solution for political development in Iraqi Kurdistan, is an ideal mechanism for the promotion of confidence-building measures between the KDP and PUK and the enhancement of administrative cooperation.

## **7.2 The Kurdistan Regional Government, 1992-1996**

The election results of 1992 presented the participating parties with a quandary. The KDP and PUK were so close that neither party achieved a majority within the KNA. After negotiations occurred between the two competing parties, a system was devised which was intended to provide some form of administration for the region and satisfy the KDP and PUK in the short-term until a new election took place. The design adopted, which effectively divided all executive and legislative positions equally with real power being unofficially vested in the political bureaus of the KDP and PUK, became known as the 50-50 system.

### **7.2.1 The Power Sharing System of the First and Second Cabinets**

While designed to alleviate the ever-present tensions apparent in the political arena, the 50-50 system was dependent upon the goodwill and support of the sources of the tension. However, within 2 years, Iraqi Kurdistan would be characterised by fierce interfactional fighting, with the power-sharing system perhaps being a catalyst rather than constraint. In analysing the development of the political system in these difficult years, I address the tensions developed by this specific power-sharing system identifying the problems of bringing the KDP and PUK together in supposed governmental harmony.

#### **7.2.1.1 The Establishment of the 50-50 System**

Events in the immediate aftermath of the elections were somewhat chaotic, with KDP personnel insisting that the PUK was preparing to fight in the precincts of Erbil rather than to become the opposition in the KNA, and the KDP similarly being provocative against the PUK. Even though several important cadres in the PUK, led by Nawshirwan Mustafa, were pushing for the PUK to become the party of the opposition, the deal brokered between the two sides resulted in an even division of power between the KDP and PUK in the KNA. However, while the system was

called 50-50, it was apparent that the KDP relinquished a considerable number of key ministerial portfolios as well as a seat in the KNA. Sami Abdul Rahman noted that *“the 50-50 was not so, it was 3:1, but the KDP tolerated it.”*<sup>1</sup> Nechervan Barzani supports this fact by naming the system “70-30”, and states that the KDP accepted the deal because they believed that another election was forthcoming.<sup>2</sup>

#### 7.2.1.2 The Aim of the 50-50 System

The aim of the system was to achieve, at least on the surface, an even division of power between the KDP and PUK in all government offices throughout the territory. Such a balance was deemed to be particularly appropriate as the two leaders of the parties remained out of the official governmental equation, postponing dealing with the most problematic issue of who was to be President. However, the exclusion of the two leaders would ultimately be identified as a serious flaw.

As seen, the Presidium of the KNA was divided between KDP and PUK personnel, with Jawher Namiq Salim of the KDP becoming the Speaker, and Mohammad Tawfiq his Deputy. An identical division was then applied to the cabinet, with the minister being from one party and the deputy from the other. However, the decision-making process of the administration was still ultimately dominated by the KDP and PUK, thereby preserving the influence of the parties' elite. Mohammad Tawfiq of the PUK Political Bureau noted to me that:

*“With the first and second cabinets, there was an unwritten understanding between the political bureaus of the KDP and PUK that all the decisions of the KRG must have [their] prior approval. So, there was a consensus of taking a decision. Both political bureaus discussed the main issues and then issued a message to the government. Sometimes it would be the government who would propose a policy, but it would still require the political bureaus to issue a decision. The political bureaus met weekly, sometimes twice weekly to discuss such issues.”*<sup>3</sup>

At the ministerial level, the deputy enjoyed the same power and influence as the minister as each needed the support of the other to plan policies and implement programmes, with each, similarly, possessing a veto. This typology of division

<sup>1</sup> Interview with Sami Abdul Rahman, Salahadin, 9 September 1999.

<sup>2</sup> Interview with Nechervan Barzani, Saryrash, 21 May 1998.

<sup>3</sup> Interview with Mohammad Tawfiq, Kalarcholan, 7 August 1999.



existed throughout the governmental structures, from the cabinet to the town councils, and also including schools, health facilities, and internal security positions.

### 7.2.2 The First Cabinet of the KRG

The first cabinet of the KRG was presented with an unenviable task of attempting to govern the newly formed *de facto* state. Within the territory, UN sanctions and the GOI embargo were creating immense socio-economic problems, in addition to the unease created by the tense political environment. Furthermore, the first cabinet had to manage several internal and structural problems. Dr Fu'ad Massoum, the PUK Prime Minister of the first cabinet, noted that;

*"We had many problems, the first problem being that the GOI system was massively overstuffed. The second problem was that the Kurdish leadership did not have enough skilled personnel, and the third problem was the Iraq had never enjoyed any democratic tradition."*<sup>4</sup>

The first cabinet targeted these problems highly effectively and the achievements of this cabinet have often been overlooked due to the subsequent breakdown of inter-party relations and the formation of the second cabinet under the premiership of Kosrat Rasoul of the PUK.

#### 7.2.2.1 Ministers and Deputies

According to most reports of the first cabinet, perhaps the greatest problem presented to the decision-making process was the equality of power which existed between ministers and their deputies creating an administration effectively hamstrung by the contrary political motivations of its highest executive members. However, in the region itself, the first cabinet, and Dr Fu'ad in particular, is often held in high regard for what they managed to achieve, and the manner by which they achieved it.

According to Dr Fu'ad, there were undeniably some problems with the minister-deputy division. However, as most decisions had actually been made in the political bureaus of the KDP and PUK with the approval of Talabani and Barzani, any

---

<sup>4</sup> Interview with Dr Fu'ad Massoum, London, 21 June 1999. Wimmer, quoting the findings of Bozarlan, suggests that the parties enlarged the bureaucratic apparatus in order to grasp the support of the professionals. Within the governorate of Suleimaniyah, the civil service staff was increased from 80 to 150,000 persons between 1991 and 1996, according to these sources. (Borzalan (1997)

**Table 7.1: The First Cabinet of the Kurdistan Regional Government****(4 July 1992)<sup>5</sup>**

<i>Name</i>	<i>Position</i>	<i>Party</i>
Fu'ad Massoum	Prime Minister	PUK
Roj Nuri Shawaise	Deputy Prime Minister	KDP
Amin Mawlud	Industry and Power	PUK
Amin Abdulrahman	Deputy	KDP
Sherko Bekass	Culture	PUK
Ahmed Salar	Deputy	KDP
Mohammad Tawfiq	Humanitarian Aid	PUK
Kamal Kirkuki	Deputy	KDP
Idris Hadi Saleh	Transport and Communication	KDP
Feyeradun Rafiq	Deputy	PUK
Younadim Yousif	Housing and Public Works	ADM
Tayyib Jabir Amin	Deputy	PUK
Nasih Ghafour	Education	KDP
Uthman Hasan	Deputy	PUK
Kadir Aziz	Agriculture	KTP
Akram Izzat	Deputy	KDP
Kamal Mufti	Peshmerga Affairs	PUK
Azad Fattah	Deputy	KDP
Ma'ruf Ra'uf	Justice	Independent
Salah al-Din Hafidh	Finance and Economic Affairs	PUK
Salah Dalo	Deputy	KDP
Kaffia Suleiman	Municipalities and Tourism	PUK
Salih Ahmed	Deputy	KDP
Kamal Shakir	Health and Social Affairs	ICP
Abd al-Ahad Afram	Deputy	KDP
Mohammad Mulla Qadir	Islamic Affairs ( <i>Awqaf</i> )	KDP
Mohammad Salih	Deputy	PUK
Ma'moun Brifkani	Reconstruction and Development	KDP
Hussein Sinjari	Deputy	PUK
Younis Rojbayani	Interior	KDP
Ahmed Sharif	Deputy	PUK

"Kurdistan: Kriegswirtschaft – Wirtschaft im Krieg" in Borck, et. al. (eds.) *Kurdologie, Ethnizitat, Nationalismus, Religion und Politik in Kurdistan*. Lit. S, pp. 79-112; Wimmer (1998) *op. cit.*, p. 5)

<sup>5</sup> Kakai (1992) *op. cit.*, pp. 123-124.



subsequent disagreement between the executive officers would be relatively straightforward to resolve as their role was essentially to implement what had already been decided.<sup>6</sup> The success of the 50-50 system therefore seemed to be guaranteed for as long as the KDP and PUK relationship remained secure, both in terms of popular support and political power. Mohammad Tawfiq of the PUK, with reference to this version of power-sharing, insisted that “[the 50/50 system] *was a very suitable and proper form of governing the region.*”<sup>7</sup>

Apart from having a decision-making process obviously dominated by the political elite of the KDP and PUK, Dr Fu’ad insists that, as Prime Minister, he was never asked to undertake anything in favour of one party or the other, and, beyond the influences exhibited by the respective Political Bureau, there was little negative interference from the parties. While still making obvious his own political convictions, Dr Fu’ad stated that;

*“There was not one day when Jalal Talabani asked the Cabinet to do anything according to the line of the political parties. Occasionally, Barzani would ask the Cabinet to perform some tasks, but this was not very often.”*<sup>8</sup>

The actual decision-making process of the cabinet therefore appears to have been managed by some form of coordination between the two political bureaus. However, there was a problem with achieving a balance within the governmental structure with regard to the inclusion of civil servants trained by the GOI, and those Kurds who had spent their lives fighting in the *peshmerga* brigades.<sup>9</sup> The civil service of the GOI had been grossly overstuffed, and Kurdistan was no exception and the inclusion of extra personnel presented the fledgling KRG with an immense problem. Dr Fu’ad noted that;

*“The problem of a large number of civil servants within the system was serious. After the Kuwait Crisis, 210,000 people of the Popular*

---

<sup>6</sup> Dr Fu’ad noted to me how close his working relationship with his deputy, Dr Roj Nuri Shawaise of the KDP Political Bureau, was, and how he went to great efforts to make sure that he consulted both Barzani and Talabani personally. He further noted that, when tensions increased and fighting broke out between the KDP and PUK, French political counsellors immediately focused upon the problems posed by the ‘equal deputy’. Interviews with Dr Fu’ad Massoum, London, 2 June 1999; Mohammad Tawfiq, Kalarcholan, 7 August 1999.

<sup>7</sup> Interview with Mohammad Tawfiq, Kalarcholan, 7 August 1999.

<sup>8</sup> Interview with Dr Fu’ad Massoum, London, 21 June 1999.

<sup>9</sup> Interview with Hoshyar Zebari, Salahadin, 29 May 2000.

*Army returned to the north, many of them civil servants, they were in addition to the civil servants we already had, and the women [in the administration] had never left their posts either.”<sup>10</sup>*

Alongside these civil servants, the political parties strove to secure positions for their most valued cadres, men who had been *peshmerga* most of their lives and committed to fighting for the cause of their parties.<sup>11</sup> Dr Fu’ad, identifying both dynamics within the governmental system, stated that he wanted to use both groupings of personnel, but that difficulties arose as a *peshmerga* thinks quite differently to a GOI trained bureaucrat.<sup>12</sup> The attempts at achieving a balance between these two groupings would create the first signs of tension between the KDP and PUK, with both sides accusing the other of placing *peshmerga* personnel into positions which required a technocrat.

### 7.2.3 The Second Cabinet of the KRG

Towards the end of 1992, the first cabinet of the KRG was becoming embattled. Faced with increasing partisan problems caused by the seemingly inextricable problem of revenue control at Ibrahim Khalil, the leadership of the cabinet attempted to become more technocratic in the face of the politicization of the governmental structures by the KDP and PUK.<sup>13</sup> This approach led to Dr Fu’ad and his cohorts becoming somewhat alienated from the decision-making bodies of the KDP and even the PUK. He noted that *“the KDP accused me of being secretive. The PUK even accused me of being so. They did not like my technocratic approach and would have preferred me to be more political in my position.”<sup>14</sup>*

The result of this attempted division between administration and party, and the effective isolation of party elites not in the administration was that the Political Bureaus of both parties would forward recommendations directly to the cabinet for

<sup>10</sup> Interview with Fu’ad Massoum, London, 21 June 1999.

<sup>11</sup> Interview with Hoshyar Zebari, Salahadin, 29 May 2000.

<sup>12</sup> Interview with Fu’ad Massoum, London, 21 June 1999.

<sup>13</sup> The arguments over the revenues of Ibrahim Khalil are somewhat confusing. Whilst the area still remained a KDP stronghold, it was the case that, as the Prime Minister, Minister of Finance and Economic Affairs, and Head of the Central Bank were all members of the PUK, the grip of the Barzanis should have been somewhat relaxed. Whenever this issue is raised amongst members of the KDP, they certainly note that the PUK indeed controlled the key administrative positions. However, the PUK retort is that the KDP *peshmerga* loyal to the Barzanis, along with the KDP Governor of Dohuk ensured that their hold on Ibrahim Khalil was not weakened at all. Interviews with Nechervan Barzani, Saryrash, 21 May 1998; Muhsin Dizayi, Salahadin, 30 May 2000.

<sup>14</sup> Interview with Dr Fu’ad Massoum, London, 2 June 1999.



implementation, a tactic which Dr Fu'ad identifies as a key weakness and a reason why he was replaced. However, this is presented somewhat differently by other PUK members. Kosrat Rasoul, the man who was to replace Dr Fu'ad as Prime Minister, explained that the removal of Dr Fu'ad was due to reasons of old age rather than his attempt to secure neutrality for the cabinet in the face of the polarization of the political system.<sup>15</sup>

### 7.2.3.1 The Formation of the Second Cabinet

The second cabinet was formed on 25 April 1993 and is characterised by the replacement of Dr Fu'ad Massoum with Kosrat Rasoul as Prime Minister of the KRG. Dr Roj Nuri Shawaise remained as the Deputy Prime Minister. Kosrat was duly given a majority vote by the KNA, and thereby legally elected to the position. It was felt that a *peshmerga* commander with a prominent background (and none were as infamous as Kosrat) could motivate the civil service at a very difficult time for the *de facto* state.<sup>16</sup> Other notable PUK appointees during this period were the enigmatic Sa'adi Ahmed Pira to the Ministry of Agriculture & Irrigation, and the infamous Jabar Farman to the Ministry of Peshmerga Affairs. Khadir Jabari of the UPK became the Minister of Justice.<sup>17</sup>

### 7.1.3.2 Analysis of the Second Cabinet

This cabinet is commonly criticized as being more partisan than that of its predecessor, and dominated by the charismatic figure of the new Prime Minister, Kosrat Rasoul.<sup>18</sup> This partisanship of the governmental structures is considered a primary reason for the subsequent fall into conflict which occurred in 1994. However, the dynamics of the second cabinet, and particularly the character of Kosrat Rasoul, may be seen to be more subtle. As a renowned *peshmerga* commander with an infamous fighting reputation, it was and is an easy task for members of the KDP to describe him as uneducated and volatile. However, he proved to be able to mobilize public support behind his cabinet and his premiership

---

<sup>15</sup> However, Dr Fu'ad's current position of head of PUK outside Iraqi Kurdistan suggests that he is not too infirmed.

<sup>16</sup> Interviews with Kosrat Rasoul, Suleimaniyah, 8 August 1999; Shwan Qliasani, Suleimaniyah 8 August 1999.

<sup>17</sup> The UPK was an amalgamation of several smaller left-wing parties, including the KPDP, the KSP and elements of PASOK. It was under the leadership of Sami Abdul Rahman.

<sup>18</sup> See Gunter (1999a) *op. cit.*, p. 75.

far more effectively than the more technically minded Dr Fu'ad. Furthermore, he was, and is, keen to portray himself as a man of the people and, particularly in Erbil, achieved this aim with great success.

**Table 7.2: The Second Cabinet of the Kurdistan Regional Government**

<i>Name</i>	<i>Position</i>	<i>Party</i>
Kosrat Rasoul Ali	Prime Minister	PUK
Dr Roj Nuri Shawaise	Deputy Prime Minister	KDP
Younis Rojbayani	Interior	KDP
Kadir Aziz Mohammad Jabari	Justice	UPK
Dr Idris Hadi Saleh	Transport and Communication	KDP
Muhammad Amin Mawloud	Industry and Power	PUK
Shirko Fayk Abdu-Allah Bekar	Culture	PUK
Dara Skeikh Nuri	Finance and Economic Affairs	PUK
Sa'adi Ahmed Pira	Agriculture and Irrigation	PUK
Kaffia Suleiman	Municipalities and Tourism	PUK
Kamal Shakir	Health and Social Affairs	KSP
Jabar Farman Ali Akbar	Peshmerga Affairs	PUK
Ma'amoun Brifkani	Reconstruction and Development	KDP
Mohammad Tawfiq	Humanitarian Aid	PUK
Mohammad Abdullah Kadir	Awqaf and Islamic Affairs	KDP
Dr Nasih Ghafur Ramadan	Minister of Education	KDP
Younadam Yousif Kana	Public Works and Housing	ADM

The truth of the activities of the second cabinet is, as perhaps to be expected, found somewhere in the midst of allegations of partisanship and the political strengths of the cabinet. KDP members have deep-rooted feelings regarding Kosrat in particular and attribute much of the failings of the 50-50 system to his influence, including his alleged use of government funds to promote his own enterprises.<sup>19</sup> However Kosrat, as an Erbillian, undeniably enjoyed huge support within the city where he came from



and, to a significant degree, deserved it for the direction he gave to the KRG at this difficult time. However, the political atmosphere in which the second cabinet had to operate was intense, with the tension between Barzani and Talabani remaining high, and neighbouring and interested countries becoming increasingly exasperated with the fact that the KRG was seemingly becoming more institutionalised in the region with the successful, and peaceful, reformation of the cabinet. As events show, in this scenario, with both major parties located in the *de facto* capital of Erbil, any change in the balance-of-power which existed between them would be critical enough to through them into a downwards spiral of violence resulting in open conflict. The following section traces the dynamics which resulted in the collapse of the 50-50 system of governance, and one of the most destructive internecine conflicts yet to take place in Iraqi Kurdistan.

#### 7.2.4 The Polarization of the Political System

As seen with the results of the elections of 1992, a structural problem was the setting of the threshold to secure a seat in the KNA at 7 percent, effectively ruling out all of the smaller parties, and several highly capable and influential politicians, including the leader of the KPDP, Sami Abdul Rahman.

##### 7.2.4.1 The Changing Position of the Smaller Parties

Realizing this weakness, the KDP and PUK agreed to lower the threshold, but, recognizing the problems faced by the new-born KNA, the smaller parties refused to take part and chose to remain in the sidelines until the next elections. After the elections, Sami led a merger of his party along with two others, the KSP and PASOK, to form the UPK. The relationships between these parties had been apparent before the elections, when the KSP and PASOK formed a joint leadership. This arrangement was then expanded after the elections to include the KPDP resulting in the formation of the UPK in August 1992. After the unification, both the KPDP and PASOK dissolved themselves placing themselves under the leadership of Sami

---

<sup>19</sup> The names normally associated with causing problems for the KDP in the Second cabinet are Kosrat Rasoul, Jabar Farman, and Dara Sheikh Nuri. Between the three of them, they exerted a huge amount of influence over the activities of the Second cabinet.

Abdul Rahman. The KSP continued to operate under the leadership of Rasoul Mamand.<sup>20</sup>

#### 7.2.4.2 Party Amalgamations

In December 1992, the KSP was dissolved as Rasoul Mamand joined the PUK Political Bureau. This event was followed by the Eleventh Congress of the KDP in August 1993, when the UPK subsequently merged with the KDP,<sup>21</sup> resulting in three of its leaders joining the KDP Political Bureau, including Sami Abdul Rahman and Muhammad Haji Mahmoud, formerly of the KSP.<sup>22</sup>

The KDP certainly fared better than the PUK from these polarizations in terms of securing increased electoral support, and perhaps increased their share of the vote in a future election by as much as 3percent.<sup>23</sup> The reasons behind this coalescence of parties, and particularly the move of Sami Abdul Rahman to the KDP, are again difficult dynamics to understand fully, particularly when one remembers the vociferous criticism aimed at the KDP and the Barzanis by Sami in the 1980s. However, it is commonly assumed that a combination of political necessity and a certain amount of pressure were responsible.

These changes did indeed send shock waves through the PUK camp and altered the balance between the groupings partaking in the already strained consociational

---

<sup>20</sup> Amnesty International (1995) *op. cit.*, p. 9; Graham-Browne & Zackur (1995) "The Middle East: The Kurds – A Regional Issue." December 1995, WRITENET Country Papers, UNHCR, Switzerland, para. 3.4; interview with Sami Abdul Rahman, Salahadin, 8 September 1999.

<sup>21</sup> The KDP refer to this union as "*sending shock-waves through the PUK camp*". It is also interesting to note that, for a brief period, the KDP became known as the Unified KDP (U-KDP). However, this was not to last. Jalal Talabani remains adamant that it was the PUK which benefited most from the amalgamations of this period. Kurdistan Democratic Party (1994) *op. cit.*, p. 7; Gunter (1996a) "The KDP - PUK Conflict in Northern Iraq." *Middle East Journal* 50, no. 2 (Spring 1996) pp. 225-241, p. 232. Interview with Jalal Talabani, Suleimaniyah, 11 September 2000.

<sup>22</sup> Mohammad Haji Mahmoud would then split from the KDP in October and re-establish the KSP under his leadership. (Amnesty International, 1995, p. 10). At the Second Conference of the KSP in November 1994, the party was renamed as the Kurdistan Socialist Democratic Party (KSDP). The Political Bureau of the KSDP was removed to an obscure location between Sa'id Sadiq and Halabja, and very close to the Iran-Iraq border, prompting several rumours that Mohammad Haji Mahmoud was receiving funds from the Government of Iran. The merger of the KSP with the KDP was an unexpected move, as many expected it to instead merge with the PUK. Jalal Talabani noted that Mohammad Haji Mahmoud was encouraged to merge with the KDP by the UK Secret Intelligence Service (SIS) which was keen to keep a balance within the political system. Interview with Jalal Talabani, Suleimaniyah, 11 September 2000.



system of governance. Prior to these changes, the two main parties were careful in their dealings with each other and effectively played the smaller parties out of the picture. The system had developed into a structure which exhibited stability through its inability to make a decision quickly. However, the inclusion of the smaller parties created a sharp polarisation between the PUK and KDP, with the KDP feeling in a stronger position to alter the perceived imbalance within the government and reduce the influence of the PUK in Erbil, and the PUK aiming to increase its own control over the revenue of Ibrahim Khalil. At the same time, Mohammad Tawfiq noted that an increase in the involvement of the neighbouring states had occurred, allowed by the division of administration and the polarization of party politics, promoting internal destabilization. These factors, throughout 1993, resulted in the efficiency of the second cabinet being reduced and the ability of the KRG to govern the *de facto* state to be dramatically weakened, particularly after the increase of the internal sanctions imposed by the GOI. The polarization of the parties also politicized the population by reintroducing politics back into society as the two main groups became more competitive. The ability of the KRG to govern the region and not allow party political colouring to invade the decision-making process became progressively weaker until public service, for example, was dependent upon overt loyalty to the controlling party.<sup>24</sup>

In January 1994, the Central Committee of the KDP met and, believing to have been strengthened by coalescing with the smaller parties, decided that the 50-50 system was no longer the favoured method of power-sharing. Massoud subsequently proposed to the KNA that a new election should take place in the immediate future.<sup>25</sup> The result of this move towards elections caused by the polarization of the parties was the decline into warfare and the division of the KRG.

---

<sup>23</sup> Interview with Nechervan Barzani, 21 May 1998. Other sources put the potential increase in support caused by this union at 9percent, calculated from the total amount of votes these three parties received in the 1992 elections (Kurdistan Democratic Party (1994) *op. cit.*, p. 7).

<sup>24</sup> For an account of life under this political system, see Suleiman (1994) "The Politics of Green and Yellow," *Dialogue*, September 1994.

<sup>25</sup> Arif Taifour of the KDP Political Bureau noted that, at this time, the KDP was increasing its military capabilities, received positive publicity from the return of the bodies of Mulla Mustafa and Idris Barzani to Iraqi Kurdistan, won the university elections, and benefited from the inclusion of the UPK. However, Talabani notes that it was he who negotiated the return of the bodies, and escorted them to Barzan, promoting his position as being the political heir to Barzani. Interviews with Arif Taifour, Salahadin, 1 September 1999; Jalal Talabani, Suleimaniyah, 11 September 2000. Kurdistan Democratic Party (1994) *op. cit.*, p. 7.



### 7.2.5 Conclusion

It is incorrect to state that the 50-50 system was doomed to failure from the outset. Indeed, the division of positions within the governmental structure was cumbersome, but the political will for the initiative to succeed in the early 1990s was sincere and resulted in the first cabinet proceeding reasonably well for a short period. While the decision-making process of the cabinet was essentially externalised due to neither Talabani nor Massoud being part of the official structures of governance, as long as the political balance remained between them, it seemed that stability would remain within the governmental sphere. Certainly, the early relationship between Massoud and Talabani suggests that their absence from the official structures was not problematic. However, if they had participated from this early point, and also included prominent politicians, such as Sami Abdul Rahman and Nawshirwan Mustafa,<sup>26</sup> it is possible that many of the subsequent problems could have been solved in a manner more acceptable to each party.<sup>27</sup> The two leaders effectively wielded political power, but did not affiliate officially with the administration, in either the legislative or the executive, resulting in a very weak system of government.<sup>28</sup>

Further fundamental problems existed which were never fully addressed. The KDP and PUK handed over control of revenue sources to the KRG in name only,<sup>29</sup> and the KRG exerted little control over the main crossing points, and particularly Ibrahim Khalil.<sup>30</sup> Similarly, the control of *peshmerga* forces was nominally handed over to the Ministry of Peshmerga Affairs, but in reality the KDP and PUK both retained full

---

<sup>26</sup> It is interesting to note that both of these important figures would later become intrinsic parts of the administrative structures, with Sami Abdul Rahman becoming Deputy Prime Minister of the KRG (Erbil), and Nawshirwan Mustafa assuming a position of senior advisor to the KRG (Suleimaniyah). Nawshirwan Mustafa has a reputation of being a 'hawk' within the PUK. However, his ideas on the development of the KRG and political system of Iraqi Kurdistan remain more balanced than his critics would suggest.

<sup>27</sup> Dr Fu'ad Massoum noted that, in 1995, the PUK suggested that both Massoud and Talabani should participate in the KRG. The KNA agreed that whatever Massoud wanted (he was reportedly offered first choice by the PUK), then Talabani would take the other position (the positions being Prime Minister and Speaker of Parliament). However, the arrangement fell through, with Barzani's supporters suggesting that he was too great to assume a governmental position, and the PUK subsequently responding likewise, resulting in the demise of the initiative. Interview with Dr Fu'ad Massoum, London, 21 June 1999.

<sup>28</sup> Interview with Dr Shafiq Qazzaz, Erbil, 18 May 1998.

<sup>29</sup> See Natali (1999) *op. cit.*, for a good assessment of the various crossing points available to the KDP and PUK at this time.

<sup>30</sup> Graham-Brown & Zackur (1995) *op. cit.*, para. 3.4.2.



control of their respective militia with the PUK Minister of Peshmerga Affairs, Jabar Farman, controlling the official financial resources. The security structures remained separated and dominated by Karim Sinjari on the KDP side, and Hackam Khadr Hama Jan on the PUK side.<sup>31</sup>

There were therefore positive and negative aspects. Positive aspects included the maintenance of a balance between the two political parties, allowing a built-in method of self-regulation. However, the negative side was that the system was essentially unworkable if the political balance did not remain and, if imbalances became apparent as they did, the inadequacies of the system would multiply as members became increasingly politically-minded in their positions.<sup>32</sup>

### **7.3 Divided Government and the Establishment of the Third Cabinets**

The culmination of the political problems which had become apparent within the second cabinet were combined with problems which existed between the major political parties, including the IMK and KSDP, resulting in the commencement of fighting in December 1993.<sup>33</sup> Neighbouring powers, notably Iraq and Iran, were also heavily involved with the deterioration of the relationship between the KDP and PUK. The result of this fighting saw the KDP expelled from Erbil and establishing a ministerial committee in Salahadin, administering the northern part of Erbil Governorate and the whole of Dohuk Governorate.<sup>34</sup> The PUK controlled the ministerial and parliamentary infrastructure of Erbil, and governing the eastern parts of Erbil Governorate, the whole of the Suleimaniyah Governorate, and the Kurdish-controlled parts of Kirkuk Governorate.<sup>35</sup>

<sup>31</sup> *Ibid.*; Gulf Newsletter, 1994, No. 10, "Conflict in Iraqi Kurdistan", p. 2; interviews with Sa'adi Ahmed Pira, Suleimaniyah, 17 April 1998; Fadhil Merani, Erbil, 26 August 1999; Karim Sinjari, Salahadin, 30 May 2000; Hackam Khadr Hama Jan, Suleimaniyah, 6 September 2000.

<sup>32</sup> Interview with Nawshirwan Mustafa Amin, Suleimaniyah, 10 August 1999.

<sup>33</sup> Gunter (1999a) *op. cit.*, p. 75. See Chapter 5 of this thesis for a comprehensive analysis of the fighting of 1993-1994.

<sup>34</sup> Interview with Arif Taifour, Salahadin, 1 September 1999.

<sup>35</sup> Officials of the KDP consistently state that it planned to forcibly retake Erbil from the PUK, but was prevented from doing so by the international community. The Drogheda peace talks which occurred between 9 and 11 August 1995 indicate the importance of maintaining a cease-fire for western powers, particularly with regard to the stability of the city of Erbil. Voice of the Islamic Republic of Iran, Tehran, 28 June 1994 (SWB ME/2035).

There were no links between the two cabinets, and the overall efficiency of both structures was fundamentally undermined by the ongoing tensions which existed between the KDP and PUK until the invasion of Erbil on 31 August 1996 by the joint forces of the KDP and GOI.<sup>36</sup>

### 7.3.1 The Division of Iraqi Kurdistan

On 31 August 1996, the combined forces of the KDP and GOI invaded Erbil, expelling the PUK from the city. The subsequent routing of PUK forces saw the KDP fully controlling Suleimaniyah Governorate.<sup>37</sup> However, successful Iranian-supported PUK counterattacks resulted in the PUK recapturing the city of Suleimaniyah, all Kurdish controlled parts of Kirkuk Governorate, and the eastern part of Erbil Governorate, centred on the town of Koysanjaq.<sup>38</sup>

A further round of serious fighting took place in 1997, but a cease-fire was reached and the division between the KDP and PUK reverted to the *status quo ante*. Particularly after the 1997 conflagration, the two political areas of Iraqi Kurdistan developed into two administrative areas, dominated by the KDP in Erbil and Dohuk Governorates, and by the PUK in Suleimaniyah and New Kirkuk Governorates. Both sides claimed legality for themselves and scorned the illegality of the other, with the political system of Iraqi Kurdistan becoming characterised by two separate, almost identical, political and administrative systems.<sup>39</sup>

---

<sup>36</sup> Interview with Mohammad Tawfiq, Kalarcholan, 7 August 1999; Voice of Iraqi Kurdistan, Salahadin, 28 May 1994, 1 January 1995, 8 March 1995 (SWB ME/2009; 2191; 2248); Voice of the People of Kurdistan, Suleimaniyah, 3 January 1995, 4 January 1995 (SWB ME/2193; 2194); Al-Hayat, London, 16 September 1996 (SWB ME/2720).

<sup>37</sup> Interview with Rast Nuri Shawaise, Erbil, 25 April 1998. Rast Nuri Shawaise was appointed Governor of Suleimaniyah for the short period which the KDP held the city. Also see Radio Monte Carlo, Paris, 6 September 1996 (SWB ME/2712); Voice of Iraqi Kurdistan, Salahadin, 8 September 1996, 10 September 1996 (SWB ME/2713; 2715); Iraqi TV, Baghdad, 9 September 1996 (SWB ME/2714); Islamic Republic News Agency, Tehran, 9 September 1996 (SWB ME/2714).

<sup>38</sup> For details of the counter-attack, see: Islamic Republic News Agency, 16 September 1996 (SWB ME/2719 & 2720); Voice of the People of Kurdistan, Suleimaniyah, 23 September 1996, 13 October 1996 (SWB ME/2726; 2743); Radio Monte Carlo, Paris, 14 October 1996 (SWB ME/2742). Also see Gunter, 1999, pp. 86-87, quoting Voice of the Islamic Republic of Iran, Tehran, 13 October 1996 (FBIS-NES)

<sup>39</sup> Dr Fu'ad Massoum described both situations as possessing aspects of illegality. Interview with Dr Fu'ad Massoum, London, 21 June 1999. For statements from the KDP and PUK concerning the illegality of the opposing administration, see: *Milliyet*, Istanbul, 22 September 1996 (SWB ME/2725); Voice of Iraqi Kurdistan, Salahadin, 27 January 1997 (SWB ME/2829).



While being extremely inefficient, this system has proved to be a stable alternative to the previous power-sharing arrangement, at least in the interim period. It has managed to preserve the influence of the political elite of both parties, and also allows governance and administration to take place with less consideration for party politics than when all political groupings were located in Erbil. Furthermore, the divide in the system implies that the potential for the *de facto* state to become more institutionalised has been somewhat diminished, thereby reducing the necessity for neighbouring states to promote instability within a unified structure.<sup>40</sup>

The system may be characterised as a geographic variant of a consociational political system. While extreme in design, however, it is argued that the cabinets of the divided administration have been the most effective of the Kurdish political institutions formed since 1991. The ability of the two main factions to dominate the administrations within their strongholds has enabled both entities to relax somewhat and promote a more effective system of administration.

The following analysis presents an assessment of 1) the structure and personnel of the third cabinets of the KRG, and 2) the strengths and weaknesses of the system, focusing primarily on a comparative analysis of the operating procedures of the PUK and KDP dominated administrations.

### 7.3.2 The Establishment of the Post-1996 Political System

The events of August 1996 culminated with the establishment system of government divided between two geographically distinct regions. The KDP consolidated its hold on Erbil and established the third cabinet of the KRG under the premiership of Dr Roj Nuri Shawaise with Nechervan Barzani as his deputy.<sup>41</sup> Similarly, the PUK secured its own stronghold of Suleimaniyah and established its own third cabinet again under the premiership of Kosrat Rasoul Ali.

---

<sup>40</sup> It is interesting to note that the regular meetings which took place between Syria, Iraq, Iran and Turkey regarding Kurdish affairs in northern Iraq ceased upon the division of the administration. They were resurrected in mid-2000 due to the obvious consolidation of the strength of the KDP and PUK. See Stansfield (2000).

### 7.3.2.1 The Formation of the Third Cabinets

Both parties staffed their cabinets with personnel from their respective political parties, or from other allied parties. However, the situation was somewhat different in Suleimaniyah as the political system of which Kosrat's third cabinet was a constituent part did not operate with a functioning legislative, whereas the system in Erbil retained a rump KNA. The KNA, while truncated with the majority of the PUK MPs fleeing the city, managed to retain a quorum with the 50 remaining KDP members, alongside the 5 representatives of the Christian community.<sup>42</sup>

The arguments concerning the respective legality of each administration may be seen as a regression, with each side appealing to earlier and earlier dates to justify their own bending of the rules. The KDP claimed that its formation of a new cabinet was legal, particularly as it believed the actions of PUK members in the second cabinet to be illegal, as was the subsequent expulsion of the KDP from Erbil in 1994. The KNA, even in its diminished form, still maintained a quorum according to Law No. 1 and therefore had the authority to alter the constitution of the cabinet. In doing so, it appointed Dr Roj Nuri Shawaise the new Prime Minister.

The PUK, similarly, declared that its administration in Suleimaniyah was the legal regional government, particularly as Kosrat Rasoul had been legally, and unanimously, elected as Prime Minister by the last full session of the KNA and had not resigned or removed legally.<sup>43</sup> With regard to the KNA, the PUK invoked parts of Laws Nos. 1 and 2, claiming that Erbil had been invaded, and transferring all legislative powers to the Prime Minister.<sup>44</sup>

---

<sup>41</sup> The third cabinet (Erbil) was formed on 26 September 1996. Voice of Iraqi Kurdistan, Salahadin, 16 September 1996, 26 September 1996 (SWB ME/2720, 2729).

<sup>42</sup> The rump-KNA held an extraordinary session on 3 September 1996 at the assembly buildings in Erbil. The aim of the session was to legitimise the gathering of the remaining KDP MPs as a legal quorum, and for extending the duration of the assembly. The assembly commenced with a symbolic count of members, which numbered 56, and identification of a quorum. The duration of the KNA was then extended to 4 September 1998 (Kurdistan National Assembly, Extraordinary Session No. 1, 3 September 1996).

<sup>43</sup> Interviews with Sa'adi Pira, Suleimaniyah, 9 June 1998; Dr Fu'ad Massoum, London, 21 June 1999; Mohammad Tawfiq; Kosrat Rasoul, Suleimaniyah, 8 August 1999.

<sup>44</sup> For opposition to this move from the KDP, see: Voice of Iraqi Kurdistan, Salahadin, 27 January 1997 (SWB ME/2829).



The ministerial structures established in Suleimaniyah were identical to those found in Erbil. However, both sides experienced initial difficulties. Suleimaniyah did not possess a ministerial infrastructure, and many of the General Directorates and governorate offices were overshadowed by the presence of the new KRG organs. Erbil had no such infrastructural problems and the KDP took over an administrative structure which was well established. However, the KDP had to contend with a reduced KNA, whereas the PUK invoked Law No. 2, giving legislative power to the Prime Minister, allowing a smooth transition of authority to take place.

### 7.3.2.2 The Divided Political System

Iraqi Kurdistan was therefore divided geographically and politically between a KDP-dominated axis of Erbil-Dohuk, and a PUK-dominated axis of Suleimaniyah-Darbandikhan. Within each area, the respective political party dominated the administration and, indeed, political life in general resulting in further polarization. However, the creation of this system enabled smaller parties to enjoy more political power as both the KDP and PUK realised the dangers of being seen to be too overly dominant, both to the Iraqi Kurdistan populace in particular, and the international community at large. Some smaller parties were included in the cabinets and virtually all of the other political parties, including those in the cabinets, operated through a structure which covered the entire Kurdish-controlled area. In this respect, it was the KDP and PUK which were anomalies and, while each dominated the political system of one-half of the area, they possessed no official presence in the opposing area.<sup>45</sup> However, no single party appeared in both cabinets, thereby polarizing the system further. Whilst the administration remained divided between Erbil and Suleimaniyah, the judiciary remained unified and was headed by the Supreme Court of the Iraqi Kurdistan Region based in Erbil. It was the presence of this unified institution, and the unwritten agreement not to alter the interim status of the position of President which seemed to exist between Talabani and Barzani, which provided a small degree of unity to Iraqi Kurdistan.

---

<sup>45</sup> Unofficially, both parties operated, and still operate in each others area, with the KDP possessing *liq* for all areas outside their control, and the PUK similarly operating *melbend* covering areas outside their own jurisdiction. From these offices, each party coordinates a system of secret cells as part of the intelligence and propaganda apparatus, alongside the offices of the *Rechrastini Taybet* (KDP intelligence) and *Zanyari* (PUK intelligence). See Chapter 5 for further details.

**Figure 7.1: Divided Government: Constituent Parts of the Political System of Iraqi Kurdistan, 1996**

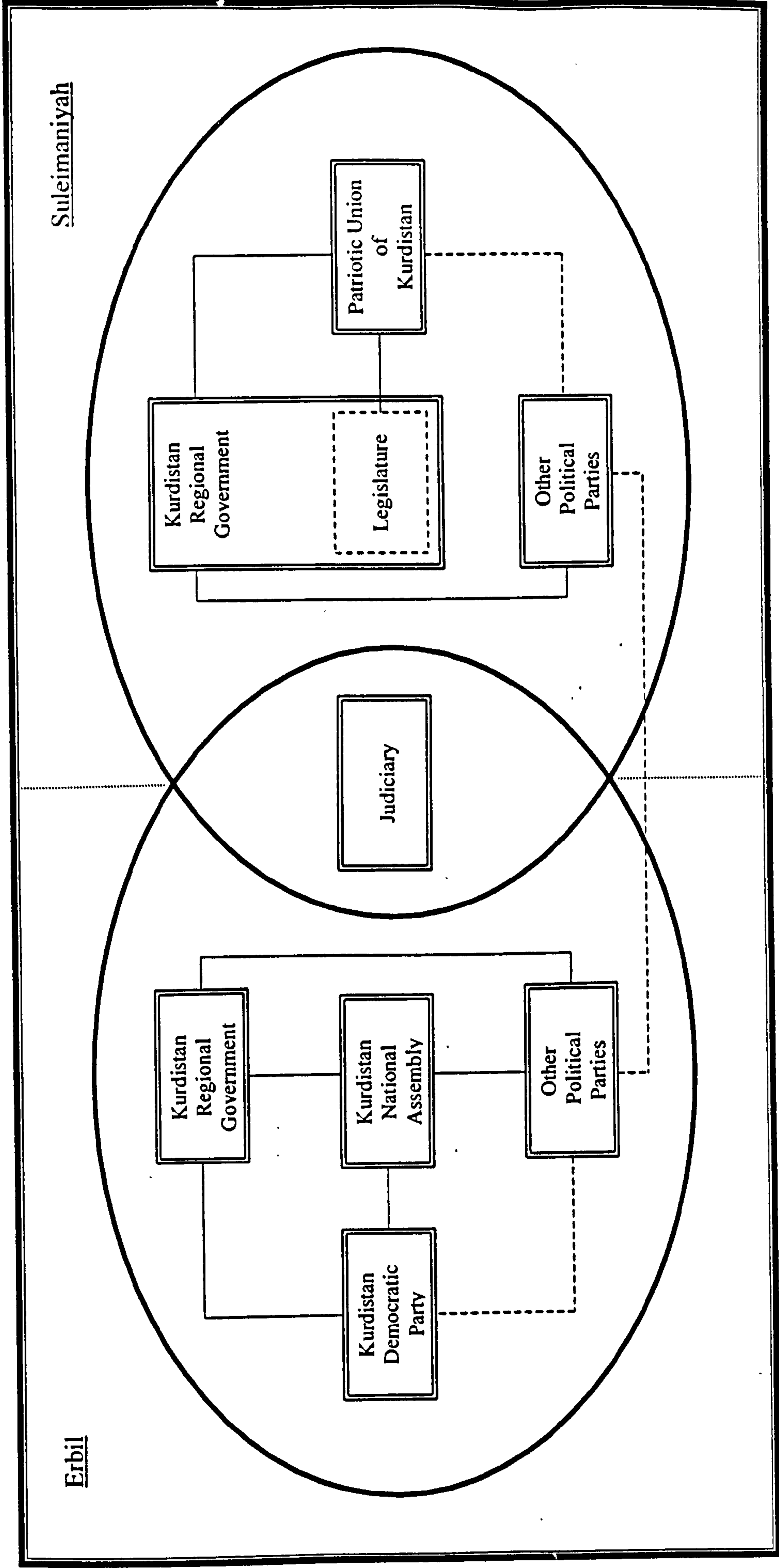



### 7.3.3 Conclusion

The two systems were dominated by the two political parties in their respective areas. Such a division has led to both parties criticizing the other system with identical claims of domination of the administrative process by the respective political party. For example, KDP cadres claim that the third cabinet (Suleimaniyah) was totally dominated by the characters of Kosrat Rasoul and Jalal Talabani (and, increasingly, Nawshirwan Mustafa), while the PUK similarly claimed that the third cabinet (Erbil) was wholly controlled by the Barzanis.<sup>46</sup>

Whilst the spheres of influence of the two KRGs undeniably present a divided system, this was not the case in the party political arena, with only the KDP and PUK not operating over the entire territory. All of the other political parties retained a party structure which covered the entire region. Furthermore, the judiciary, on paper at least, remained unified and the potentially highly divisive issue of President remained suspended.<sup>47</sup>

However, the internal dynamics of the PUK and KDP, and particularly in the leadership structures, were and are not necessarily homogenous and it is somewhat simplistic to state that the administrations were and are controlled by either Massoud or Talabani. The third cabinets were certainly heavily influenced by their respective parties, but, perhaps more so by the internal divisions within them and prevailing aspects of the political economy as dictated by the continuing development of the UN oil-for-food programme. However, it is my contention that the operating procedures of these cabinets display a situation where party politics was more removed from the administrative structures than in the previous two cabinets.

## 7.4 The Third Cabinets of the Kurdistan Regional Government

The following analysis studies the morphology, prescribed mechanisms and decision-making processes of the governance structure during the period of the third cabinets

---

<sup>46</sup> It is a strong belief of PUK members that Dr Roj Shawaise, the Prime Minister of the third cabinet (Erbil), while being a highly capable politician, was nothing but a façade due to the presence of Nechervan Barzani as his deputy. Interviews with Nechervan Barzani, Saryrash, 21 May 1998; Sa'adi Pira, Suleimaniyah, 9 June 1998; Mohammad Tawfiq, Kalarcholan, 7 August 1999.

<sup>47</sup> It was the PUK's change on the status of the Judiciary and the President in late 1999 would create an upsurge in tension between the two parties.

(1996-1999), and the early stages of the fourth cabinet (Erbil), and the re-organized third cabinet (Suleimaniyah) of early 2000.

#### 7.4.1 The Kurdistan Regional Government (Erbil)

##### 7.4.1.1 General Morphology and Prescribed Mechanisms of the Political System

After the expulsion of the PUK from Erbil, the KDP dominated the city and, indeed, the KNA. All ministries remained intact, as they would also later do in Suleimaniyah. The KNA continued with, according to the KDP rump, a legitimate quorum. The judiciary continued to operate over the entire territory, with the Ministry of Justice dealing with its administrative affairs within the sphere of influence of the KDP. The design and structure of the administrative system did not deviate from that prescribed by the earlier laws of the IKF and the KNA. The KDP was vociferous in its claims of the legislative possessing real power within the decision-making structure, and the judiciary remaining truly independent of any party-political colouring.<sup>48</sup>

##### 7.4.1.2 Cabinet Composition

The KDP wasted little time in consolidating its hold on Erbil and solidifying its new position. The KDP-dominated KNA convened on 1 September 1996 in Erbil, dissolved the previous cabinet and asked Dr Roj Nuri Shawaise to accept the position of Prime Minister, a position which he duly accepted. The design of the third cabinet was identical to that of previous cabinets, but was composed almost entirely of members of the KDP.<sup>49</sup> In the initial composition, the IMK was given two portfolios. However, these were subsequently withdrawn by the KDP when the IMK joined the third cabinet in Suleimaniyah.<sup>50</sup> Other parties which participated included the ADM and ILP. Each of these parties had reasonably strong links with the KDP, either through their inclusion in the KNA (as was the case with the ADM), or simply hoping to benefit from the increased legitimacy offered by securing a seat in the regional executive (as in the case of the ILP).

<sup>48</sup> Interview with Dr Shafiq Qazzaz, Erbil, 18 May 1998.

<sup>49</sup> Dr Shafiq Qazzaz noted that, even though the *de facto* state had been a reality for 5 years, it was still not possible to upgrade the Ministry of Humanitarian Affairs and Cooperation to a Ministry of Foreign Affairs. He suggests that the reasons for this were perhaps more to do with the fact that external governments had become used to going directly to Massoud and Talabani rather than the Prime Minister due to the administration not being internationally recognised. Interview with Dr Shafiq Qazzaz, Erbil, 18 May 1998.

<sup>50</sup> Voice of Iraq Kurdistan, Salahadin, 9 August 1997 (SWB ME/2994).



**Figure 7.2: The Constituent Parts of the Political System of Erbil-Dohuk**

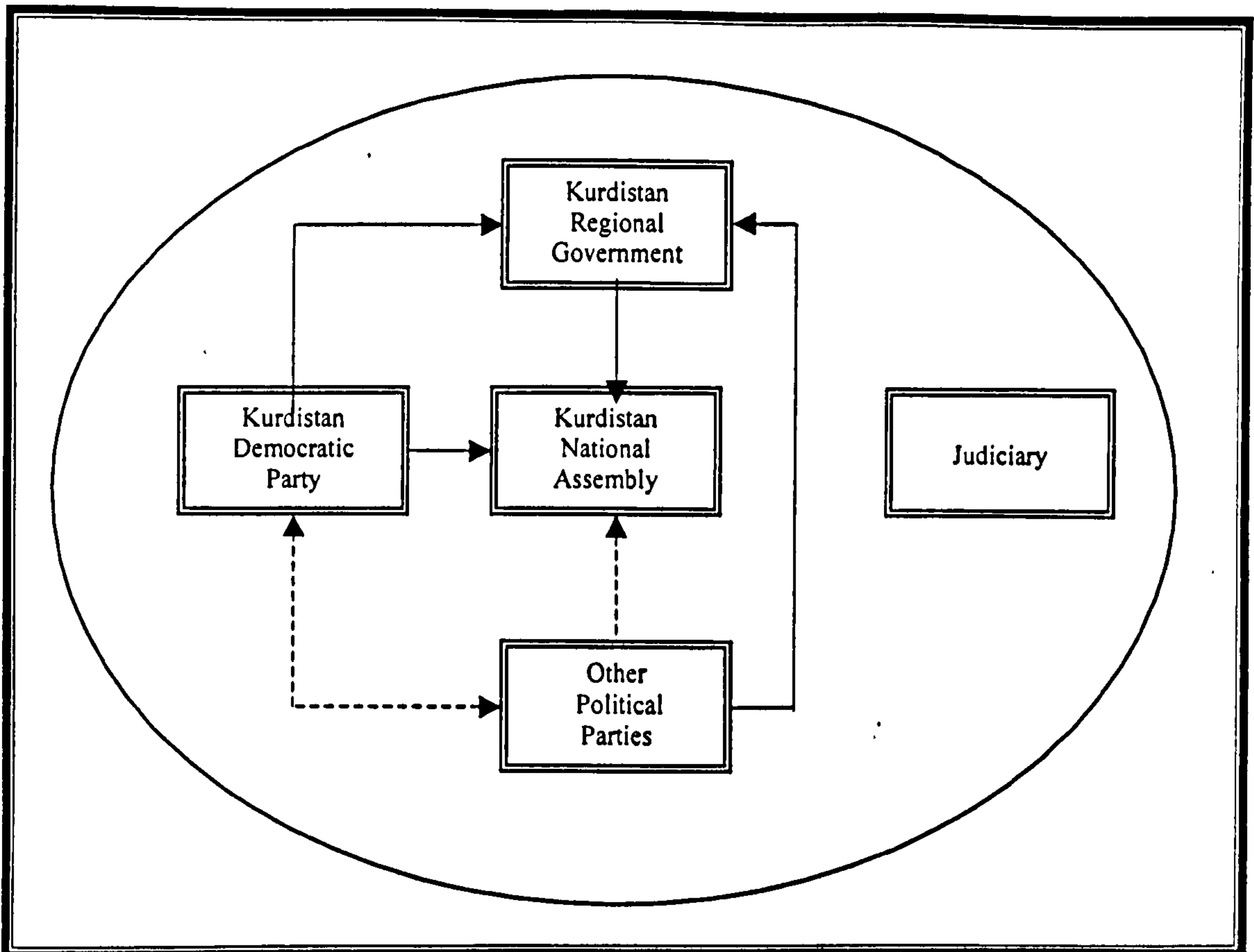

#### 7.4.1.3 The KDP and KRG Relationship

The third cabinet (Erbil) presents numerous points of interest. It is reasonably straightforward to see that the KDP dominated its composition in terms of its members holding all of the key ministerial portfolios. Furthermore, the KDP held 51 of the 56 seats of the KNA, with the Speaker and Secretary also being members of the party. However, whilst many see these factors as obvious indicators that the executive and legislative was controlled from Saryrash by the Barzanis, it is apparent that, when the backgrounds of individual ministers are investigated, this cabinet benefited from the inclusion of some highly educated and technically minded individuals. For example, the cabinet had 5 members with doctorates and several trained engineers, in addition to the regular quota of *peshmerga* cadres.<sup>51</sup>

**Table 7.3: The Third Cabinet (Erbil) of the Kurdistan Regional Government**

<i>Name</i>	<i>Position</i>	<i>Party</i>
Dr Roj Nuri Shawaise	Prime Minister	KDP
Nechervan Barzani	Deputy Prime Minister	KDP
Shawkat Sheikh Yazdeen	Finance & Economic Affairs	KDP
Younadim Yousif Kana	Public Works & Housing	ADM
Khadir Jabari	Justice	KDP
Abu Hikmat	Agriculture & Irrigation	ILP
Dr Jerjees Hassan	Minister of Education	KDP
Dr Shafiq Qazzaz	Humanitarian Aid	KDP
Dr Idris Hadi Saleh	Power & Industry	KDP
Sheikh Ma'amoon Brifkani	Reconstruction & Development	KDP
Fadhil Merani	Interior	KDP
Falakadin Kakai	Culture	KDP
Hussain Sinjari	Municipalities & Tourism	KDP
Dr Hameed Acrayi	Transport & Communication	KDP
Kamal Shakir	Health & Social Affairs	KCP
Kawa Mahmoud Hafeed	Awqaf & Islamic Affairs	KDP
Za'een (Rafiq) Ali	Peshmerga	KDP
Dr Jasim Elias	Minister of Region	KDP
Franso Hariri	Minister of Region	KDP

#### 7.4.1.3.1 *The Position of Massoud Barzani and the Political Bureau*

As with the 1992-1996 system, Massoud Barzani did not have an official position within the post-1996 governmental structure. However, it is undeniable that he exerted a significant influence over the actions of the administration through the Political Bureau of the KDP, of which many of the ministers were also members. The relationship between the Political Bureau of the KDP and the cabinet and structures of governance is a key issue to develop and analyse. It is unrealistic to expect the KDP not to exert an influence over the administration to some extent and criticisms

<sup>51</sup> Interview with Hoshyar Zebari, Salahadin, 29 May 2000.



of the partisanship of the Iraqi Kurdish administrations are somewhat unfair. It is a fact of a party political system that administrations often adopt the colouring of the party in power. However, the degree of control exerted by the party over the administration is of interest, and particularly the amount of autonomy the administration does, or does not, have over its supposed mandated areas.

Members of the KDP, as expected, describe the political system of Erbil and Dohuk as exhibiting a division between the constituent parts as identified in Figure 7.2. The position of the KNA in this system may seem to be somewhat weakened with it being dominated by KDP MPs, and with the KDP Political Bureau and third cabinet seeming to be somewhat interchangeable in terms of members.

The Deputy Prime Minister of the third cabinet (Erbil), and, later, Prime Minister of the fourth cabinet, Nechervan Barzani, admitted that critics see the KNA as a superficial entity, particularly with his own involvement in the executive office. However, he noted that the KNA often rejected proposals from the cabinet regarding possible policies, or prevented the cabinet from undertaking actions deemed to have been planned without regard for the methods in the prescribed laws.<sup>52</sup>

Dr Shafiq Qazzaz, the erudite Minister of Humanitarian Affairs & Cooperation, when describing the reasons as to why the third cabinet may have been described as operating independently from the KDP, stated that:

*“Massoud Barzani stayed outside the formal structure of Government for the duration of the third cabinet. He ha[d], both as leader and President of the KDP given great freedom of action to the administration and supported the government in financial [terms] and [by the] provision of personnel. [He] allowed the cabinet to work*

---

<sup>52</sup> Specific examples provided by Nechervan Barzani of the KNA exercising its authority include the following: The KNA nullified the appointment of a deputy minister made by the cabinet in April 1998. The KNA rejected the appointment according to Laws 1, 2 & 3, as the mandate of the cabinet does not cover senior appointments. A second example is of the Security Committee of Erbil deciding to execute individuals convicted of serious crimes with the approval of the cabinet. The KNA again refused to allow this and referred it to the Courts. Jawher Namiq Salim, the Speaker of the KNA, whilst being a member of the KDP Political Bureau, similarly went to great lengths to illustrate that the KNA, as an institution, was not under the influence of the KDP, or, indeed, any other party, citing the famous sit-in of 1994 which was conducted against both the KDP and PUK in an attempt to stop the fighting. Interviews with Nechervan Barzani, Saryrash, 21 May 1998; Jawher Namiq Salim, Erbil, 8 September 1999.

[and] *did not breathe down the necks of ministers – the government was allowed to function as a government.*"<sup>53</sup>

In discussing his relationship with the administration and the third cabinet, Massoud Barzani himself notes the preponderance of KDP Political Bureau cadres, but still claims that the administration is independent. When discussing these points, he promoted a realistic view of the relationship between the KRG and KDP by stating that *"the KDP cannot interfere with the technocratic ministries, and instead will always support them. But they are not separate as the KDP guides the general political development of the KRG in Erbil."*<sup>54</sup>

Such guidance includes controlling the personnel of the higher echelons of the executive in particular. For example, cabinet re-shuffles are decided upon by the Political Bureau and, similarly, changes in the composition of planning departments and ministerial oversight committees have come directly from the Political Bureau. Sami Abdul Rahman noted that *"no Political Bureau member is allowed to directly interfere with the running of the administration. However, all ministerial and governors positions have to be selected and approved by them."*<sup>55</sup>

One of the most influential members of the KDP Political Bureau, Fadhil Merani, also held the position of Minister of the Interior in the third cabinet, and subsequently kept it in the fourth cabinet. He again describes a political system characterised by the separation of roles and believes that it is in the interests of the KDP to be seen to operate this type of system as it enhances the legality of both organizations. When illustrating the relationship between party and government, he noted that;

*" . . . many members of the leadership of the KDP are also in the third cabinet, and we meet weekly in the Political Bureau as well as in the cabinet. Plans for government are certainly discussed in the Political Bureau, but instruction is passed through the Prime Minister. The cabinet then takes a decision. It is possible for the cabinet to reject proposals. Similarly, with the legislative, the Speaker of Parliament is also in the Political Bureau and relays requests from the Political Bureau to the Assembly where they are accepted or rejected by the expert committees."*<sup>56</sup>

<sup>53</sup> Interview with Dr Shafiq Qazzaz, Erbil, 18 May 1998.

<sup>54</sup> Interview with Massoud Barzani, Saryrash, 22 August 1999.

<sup>55</sup> This was also supported by Nechervan Barzani. Interviews with Sami Abdul Rahman, Salahadin, 3 April 1998; Nechervan Barzani, Saryrash, 21 May 1998.

<sup>56</sup> Interview with Fadhil Merani, Erbil, 26 August 1999.



Particularly with regard to the daily procedures of government, KDP-KRG officials admit that many issues have not been thought through comprehensively, particularly with regard to the relationship between local government offices and party offices in the districts and sub-districts. Hoshyar Zebari noted that this weakness stems from the fact that the KDP, and the other political parties, have always been reacting to a situation which is highly dynamic. Now, within Erbil, Hoshyar noted that difficulties may arise over security and between the offices of the Governor and *Leqi Du* of the KDP, particularly due to the fact that the current Governor, Akram Mantik, used to be a member of the security service of the KDP, and the current head of *Leqi Du*, Franso Hariri, used to be the Governor of Erbil.<sup>57</sup> In principle, the KDP is informing their party offices to stay out of the affairs of the KRG and administration, however, in practice it is sometimes proving to be difficult.

A further interesting relationship between the KDP and the KRG (Erbil) can also be seen before and after the Washington Agreement. Before the agreement, the KDP position toward the administration was one of indirect intervention. However, after the agreement, with its calls for elections, the KDP has been increasingly keen to associate itself with the activities of the KRG, and particularly the public service ministries, and promoted highly visible programmes such as road building and infrastructural developments within the cities. Since August 1997, the Ministry of Finance and Economic Affairs estimates that it has spent a total of 237 million OID (US\$ 13 million) on infrastructural development projects in the governorates under its jurisdiction.<sup>58</sup>

#### 7.4.2 The Kurdistan Regional Government (Suleimaniyah)

After the evacuation of Erbil by the PUK and the subsequent counterattack in the autumn of 1996, the PUK part of the KRG resurrected itself in Suleimaniyah. While

---

<sup>57</sup> Similarly, Hoshyar joked that when Sami Abdul Rahman was the head of the Political Bureau he insisted that the Political Bureau was the centre of the decision-making process. Now, as Deputy Prime Minister, his opinion has changed somewhat. Interview with Hoshyar Zebari, Salahadin, 29 May 2000.

<sup>58</sup> The impact of these activities on the citizens of Erbil has been one of appreciation alongside an understanding that the KDP is trying to buy allegiance for the future. For example, when I asked an inhabitant of Erbil city what his opinion was of a new road widening scheme which had taken place between Erbil and the KDP stronghold of Salahadin, his reply was that it would allow the constant

seemingly similar in terms of possessing an identical executive structure, the KRG in Suleimaniyah displayed some considerable differences compared to the previous system left behind in Erbil.

The problems faced by the KRG in Suleimaniyah were a reflection of the polarised geopolitical position the PUK found itself in after August 1996. The PUK suffered from a lack of revenue, compounded by the fact that it now had a full government structure, albeit substantially reduced in size, and a large body of pro-PUK civil servants who had fled Erbil. These problems of finance and imbalance in party-personnel structure were added to the simple fact that Suleimaniyah, whilst being a cultural and educational centre for Iraqi Kurdistan, did not possess the necessary infrastructure to support an administration.

#### 7.4.2.1 General Morphology and Prescribed Mechanisms of the Political System

The PUK re-established all the ministries of the second cabinet. However, there was a problem with reforming the KNA in Suleimaniyah as any gathering under its name would not achieve a quorum as the KDP and Christian MPs remained in Erbil, as did a handful of PUK members. Therefore, the PUK, through the Prime Minister, invoked certain articles of Laws No. 1 and 2. Their interpretation of the laws officially handed legislative authority to the Prime Minister, Kosrat Rasoul, but in reality to the PUK Political Bureau. The judiciary continued to operate within Suleimaniyah and Darbandikhan in a unified manner under the Supreme Court of Erbil. However, the administrative affairs of the judiciary within the sphere of influence of the third cabinet (Suleimaniyah) were handled by the new Ministry of Justice.

#### 7.4.2.2 Cabinet Personnel

The position of the PUK with regard to the establishment of the third cabinet is that, as the previous cabinet had not been legally dissolved by the KNA, Kosrat Rasoul was still the Prime Minister of the KRG and, due to the invasion of Erbil, had the legal right to establish any administration he saw fit in the new political situation. The PUK therefore proceeded to establish the third cabinet in late 1996. This cabinet

---

flow of ministers which run between Erbil and Salahadin to receive their daily instructions more



was again a coalition of parties, but parties already in the Erbil coalition were not included. Parties included in the Suleimaniyah coalition were the PUK, KTP, Conservatives, and, at a later date, the IMK.<sup>59</sup> The PUK held all the major portfolios, although many deputy positions were awarded to the coalition partners, including the

**Figure 7.3: The Constituent Parts of the Political System of Suleimaniyah**

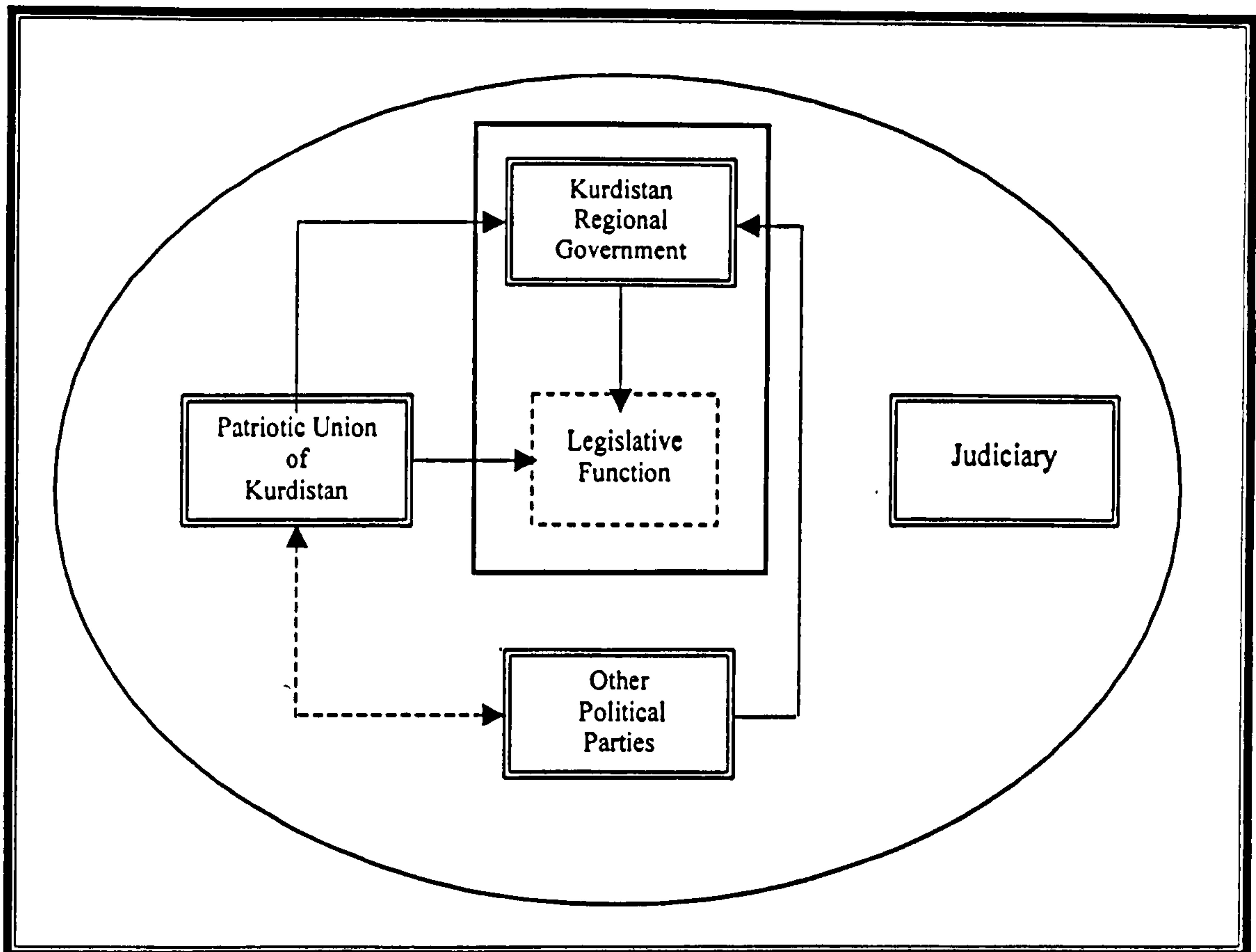

Ministry of the Interior which was handed to the IMK. The parties in the cabinet were a mix of those who were directly aligned with the PUK, as in the case of the KTP; those which had little in common with the PUK apart from opposition to the KDP, as was the case with the Conservatives; or those which were forced into coalition and which had to join due to the strength of the PUK in their geographic area, as was the case with the IMK.<sup>60</sup>

easily.

<sup>59</sup> KTP: Kurdistan Toilers' Party; Conservatives: Kurdistan Conservative Party, led by Agha Surchi, this party is directly opposed to Barzani and the KDP. When the IMK joined the Suleimaniyah cabinet in 1997, the KDP expelled the IMK from the third cabinet (Erbil).

<sup>60</sup> The IMK's stronghold of Halabja is in the governorate of Suleimaniyah and comes under the executive authority of the PUK Governor. Furthermore, the proximity of Halabja to Suleimaniyah

**Table 7.4: The Third Cabinet (Suleimaniyah) 1998**

<i>Name</i>	<i>Position</i>	<i>Party</i>
Kosrat Rasoul Ali	Prime Minister	PUK
Dr Kamal Fu'ad	Deputy Prime Minister	PUK
Dara Sheikh Nuri	Finance & Economic Affairs	PUK
Adil Nasr	Public Works & Housing	PUK
Abdul Rahman Nawrasi	Justice	IMK
Salar Aziz	Agriculture & Irrigation	PUK
Arsalan Bayaez	Education	PUK
Sa'adi Pira	Humanitarian Affairs	PUK
Bahman Hussein	Reconstruction & Development	KTP
Mu'alizim Omer Abdullah	Interior	PUK
Jamal Abdullah	Culture	PUK
Kaffia Suleiman	Municipalities & Tourism	PUK
Najim Hussein Surchi	Transport & Communication	Conservative
Ihmad Ahmed	Health & Social Affairs	PUK
Mohammad Abdul Aziz	Awqaf & Islamic Affairs	IMK
Kamal Mufti	Peshmerga Affairs	PUK

#### 7.4.2.3 The PUK and KRG Relationship

The establishment of the third cabinet (Suleimaniyah) was a brave move by the PUK, and their subsequent intelligent legal defence of their actions has been a match for the KDP, even if the tenets of Laws Nos. 1 and 2 were at times stretched. Once again, the new cabinet certainly contained some impressive members. Many of the previous ministers of the second cabinet retained their posts, and these were joined by a number of resourceful technocrats, including Bahman Hussein of the Toilers' and the Yezidi, Adil Nasr. Perhaps the most important of the additions to the cabinet was the assiduous Dr Kamal Fu'ad of the PUK Political Bureau, a founder member of the

---

made it imperative that the IMK should attempt to conciliate with their foe of 1994 if they were to continue to enjoy some security within Halabja. The inclusion of the IMK into the third cabinet (Suleimaniyah) did not overtly antagonise the KDP, with whom the IMK continued to have good relations, but the KDP was not prepared to keep a governmental coalition partner of the PUK within its own cabinet.



PUK and a character with the political experience to complement that of the Prime Minister and also act as the proxy of Talabani within the cabinet.<sup>61</sup>

However, life for the new cabinet was never going to be easy, with the PUK in an embattled position and even further away from the sources of revenue, as well as having to cope with being located in one small city. The concentration of cadres caused by the influx of PUK personnel from Erbil into Suleimaniyah created many serious problems. As Prime Minister, Kosrat Rasoul formed his new government quickly, and was understandably dependent upon his trained staff from Erbil. However, the geographical division which had become increasingly apparent within the PUK, and with which Kosrat was associated, now became focused within the structures of the administration.<sup>62</sup>

The resultant atmosphere within the city becoming highly charged, with so many ministers, party personnel, governors and the Prime Minister all being in one place.<sup>63</sup> One of the first indicators of a change occurring within the political elite of the PUK was the expulsion from Suleimaniyah of a string of governors including Salar Aziz and Feyeradun Abdelkadir, both Suleimaniyah-members of the PUK. Their replacement with the previous Head of *Asayash* (secret police) of Erbil, Hackam Kadr Hama Jan, emphasised the distinctly Erbil-styling which became common in Suleimaniyah.<sup>64</sup>

#### 7.4.2.3.1 *The Position of Jalal Talabani and the Political Bureau*

As was the case with Massoud Barzani, Jalal Talabani did not have an official position within the third cabinet. However, in the claustrophobic political maelstrom of Suleimaniyah after 1996, it was to be expected that the most influential of political characters would exert a significant degree of control over the administrative system.

---

<sup>61</sup> Dr Kamal Fu'ad is a lawyer by training and held the Chair of Kurdology at the University of Suleimaniyah for a number of years.

<sup>62</sup> See Chapter 6 for details of this division.

<sup>63</sup> Nawshirwan Mustafa noted with considerable humour that Suleimaniyah was home to '*at least 10 governors, everybody wants to be governor*'. Interview with Nawshirwan Mustafa Amin, Suleimaniyah, 10 August 1999.

<sup>64</sup> Interview with Hackam Khadr Hama Jan, Suleimaniyah, 6 September 2000.

The cabinet had, at any one time, no less than 5 ministers who were also members of the PUK Political Bureau, and several who were in the Leadership Office.<sup>65</sup>

Once again, PUK members are keen to forward the opinion that there remains a division between administration and party within the third cabinet, and to a greater degree than what occurs in Erbil, possibly due to the personality of Kosrat Rasoul.<sup>66</sup> However, it is interesting to then note that those same members of the PUK do not describe this division as being clear-cut. Mohammad Tawfiq, a well-respected member of the PUK Political Bureau and minister of the first cabinet, stated the following:

*"[it is] the PUK [which] administers the area. The administration is meant to be independent of the political parties, but the Political Bureau dominates and nominates down to even the headmaster of a school. In the 50/50 administration, everything was controlled by the administration, but after the split, the administration became heavily dependent on the parties. In technical matters, experts advise on general policy, and this will always be accepted by the Political Bureau."*<sup>67</sup>

Such a relationship between the PUK and KRG is grounded in both the political and economic conditions found in Suleimaniyah since August 1996. It is no secret that the economic situation of the PUK within Suleimaniyah is severely constrained by the inability to secure significant revenue from its border crossings, and this has filtered down to the KRG. One of the major impacts of this lack of funds is the drawing together of the administration and the PUK, with the Political Bureau having a pre-eminent position in the decision-making process. In addition to these reasons, Mohammad Tawfiq, includes the lack of international recognition for either of the fledgling administrations:

*"In the political bureau, all subjects, including government and administration, are discussed. The states surrounding Iraqi Kurdistan will not deal with the KRG and therefore the political bureau is the*

<sup>65</sup> It is difficult to put an exact figure on the numbers of personnel who were also in decision-making organs of the PUK as both the Political Bureau and the third cabinet (Suleimaniyah) were characterised by a much higher turnover of personnel than what occurred with the KDP Political Bureau and the third cabinet (Erbil).

<sup>66</sup> Conversely, Nechervan Barzani, now Prime Minister of the KRG (Erbil), stated that the Suleimaniyah administration is totally dominated by Kosrat Rasoul and Jalal Talabani. Interview with Nechervan Barzani, Saryrash, 21 May 1998.

<sup>67</sup> Interview with Mohammad Tawfiq, Suleimaniyah, 14 May 1998.



*main [conduit of contact] between the political parties and the surrounding governments. Therefore, for this reason, the political bureau ends up ordering the government.”<sup>68</sup>*

When discussing this relationship, the then Minister of Humanitarian Aid & Cooperation, Sa’adi Pira, went to great lengths to describe the division which exists between the party and administration within Suleimaniyah. However, he also identified that, at times, it is more beneficial for both the party and administration to ‘join’ certain aspects of their structures, using his own position as an example. From 1996 to 1999, he was Minister of Humanitarian Aid & Cooperation, and also headed the PUK Foreign Relations Bureau. Both positions are complementary, with the ministry dealing mainly with NGOs and UN agencies within Iraqi Kurdistan, and the Foreign Relations Bureau representing the PUK in particular to the outside world. As well as the minister being involved with both offices, several civil servants/party cadres similarly performed a dual party-administration role.<sup>69</sup>

#### 7.4.3 Conclusion

The divided system of government which has characterised Iraqi Kurdistan since 1996 has been responsible, to a significant degree, for the maintenance of a fragile peace. In addition, the socio-political tensions created by having the KDP and PUK held together in a tight power-sharing system were relieved and both sides could address the domestic affairs of the *de facto* state in a more efficient manner, without worrying about the activities of their counterparts. Fadhil Merani, the Minister of Interior of the third cabinet (Erbil), is responsible for security within Erbil and Dohuk Governorates. He noted that, since 1996, the KDP and PUK have controlled the security of their respective regions in a more satisfactory manner than when they were together. He attributed this change to the organs of security now receiving instruction from one source, rather than from two:

*“After the separation of 1996, security was much improved, even in Suleimaniyah, because of the recognition of one executive power in both places. Each party and administration had less need to worry about the internal party situation within their respective areas, each*

<sup>68</sup> Interview with Mohammad Tawfiq, Kalarcholan, 7 August 1999.

<sup>69</sup> Interview with Sa’adi Pira, Suleimaniyah, 9 June 1998.

*was also trying to show that they were legal, powerful, and had an operating security and justice system.”*<sup>70</sup>

According to the minister, evidence of this change can be seen in the lower crime rates characterising Iraqi Kurdistan.<sup>71</sup> Similarly, Hoshyar Zebari noted that the current system is much easier for both the KDP and PUK to operate, mainly because there is no longer competition between them in staffing the offices of the KRG.<sup>72</sup>

The major problem now facing the KRGs is that of finances combined with an inefficient planning mechanism. Any government has to know the sources of income before they know how it is going to spend the money. However, as governments, neither cabinet knows the future level of inputs into the system, especially as income is dependent upon the actions of, and relationships with, Iran, Iraq, Turkey, the UN and the internal relationship with the other party. Even though the KDP controls considerable resources at Ibrahim Khalil, its vulnerability has been shown on numerous occasions when Turkey has stopped the flow of trade. Furthermore, due to the *de facto* status, neither side can receive loans and, due to the constantly changing socio-economic situation and emergency situation, personal taxation has proved impossible to implement.

Furthermore, both Prime Ministers (Kosrat Rasoul and Nechervan Barzani) recognise that the ability of the KRGs to adequately plan policies and programmes is also severely limited, and is, in part, detrimentally affected by the huge amounts of funds being circulated in Iraqi Kurdistan by the oil-for-food deal, via UN agencies. As we shall see, the provision of such sums has created a culture of dependency not only in Kurdish society, but also within the administrative structures, with both Prime Ministers and Political Bureaus now attempting to resolve this problem.<sup>73</sup>

---

<sup>70</sup> Interview with Fadhil Merani, Erbil, 26 August 1999. Fadhil Merani is also a highly influential member of the Political Bureau.

<sup>71</sup> *Ibid.* In support of this argument, the minister discussed the problems faced by the Judiciary during the 50-50 system. Even if the Justice Department gave an order to arrest a suspect, the implementation of the order it would always depend upon the political party of which the suspect was associated allowing the arrest to take place. These sentiments were also supported by Hackam Khadr, who was the PUK appointee for security issues within the joint-KRG. Interview with Hackam Khadr, Suleimaniyah, 6 September 2000.

<sup>72</sup> Interviews with Hoshyar Zebari, Salahadin, 29 May 2000; Muhsin Dizayi, Salahadin, 30 May 2000; Karim Sinjari, Salahadin, 30 May 2000.

<sup>73</sup> Interviews with Sami Abdul Rahman, Salahadin, 1 August 2000; Kosrat Rasoul, Suleimaniyah, 26 August 2000, 1 October 2000; Nechervan Barzani, Saryrash, 22 October 2000.



The development of the Kurdish political system in terms of political parties and institutions of government has now been established. The peaceful development of the political system, particularly since 1997, is evidence of the current suitability of the geographic-consociational system which has been in existence since 1996. The following section provides an analysis and assessment of the decision-making process of the two cabinets, identifying areas of similarities and differences, and possibilities for the enhancing of governmental cooperation and consolidation. Even if party political differences remain severe enough to keep the Iraqi Kurdish region administratively divided, an ongoing programme of cooperative activities between the administrations could be an area of collaboration which encourages the normalization of the political system in Iraqi Kurdistan, firstly to a standard consociational power-sharing system, and eventually to a fully-fledged democratic system of government.

## **7.5 Analysis of the Policy Making Process of the Third and Fourth Cabinets**

While it is certainly the case that I have benefited from numerous interviews with officials of the KRGs and political parties of the region, as well as observers of Kurdish politics in general, any conclusions based on such findings would suffer to a certain degree from bias and ambiguity. This fact is not a fault of the officials who have been kind enough to spend considerable amounts of time discussing their perceptions of the political system, but rather of the nature of the political atmosphere within Iraqi Kurdistan. In order to corroborate the analysis constructed from interviewing those politicians who hold decision-making responsibility within the administration, I requested, and was allowed, to undertake a further programme of research within the administrative structures themselves.

### **7.5.1 Framework of Analysis**

The ministries I targeted for this most important aspect were those which I considered to be the most accessible and which provided evidence of most aspects of the policy making process of the administration and possible cross-linkages with other components of the political system, including the executive offices of the governorate and the political parties. I therefore targeted the ministries of agriculture

& irrigation, education, reconstruction & development, municipalities & tourism, and health & social affairs within the two administrative systems.<sup>74</sup>

Once inside the ministries, I identified a range of governmental activities which together would illustrate comprehensively the manner in which the administrative structure operates, in terms of planning and implementation. With a set of target programmes, I then assembled all the relevant paperwork and interviewed personnel involved with the particular assignment, as well as sometimes visiting the area targeted by the programme if applicable. It should be noted that the findings represent a 'snap-shot' of the Iraqi Kurdish administrative process in action. As such, they do not pertain to account for all possibilities, but serve as indicators of governmental activities.

### 7.5.2 Analysis of the Kurdistan Regional Governments

Within the KRGs, I studied primarily the programmes of the Ministries of Reconstruction & Development, Education, Municipalities & Tourism, Health & Social Affairs, and Agriculture & Irrigation. From these ministries, I selected a range of case studies which showed the decision-making process in full, and illustrated cross-agency cooperation (including NGOs), and programmes which may be deemed as failures as well as those considered successful.

#### 7.5.2.1 The Initial Planning Process

A point of great concern for the Prime Ministers is the initial planning process. The lack of reliable data within the local authority structure, combined with a seemingly patrimonial system of distribution supported by the huge funds being made available by the oil-for-food programme through the UN agencies, has resulted in the poor targeting of policies and programmes. Both Nechervan Barzani and Kosrat Rasoul, for example, cited this as the major weakness within the administrations which they

---

<sup>74</sup> As these ministries are also key public service ministries, the civil servants within these institutions were more used to working with foreigners, something which is not common within Iraq, and the majority of their ministerial programmes would not be considered politically confidential, as would be the case with the Ministry of Peshmerga Affairs, for example.



are attempting to correct. In doing so, both Prime Ministers have passed legislation allowing for the establishment of a Central Statistics Office (CSO).<sup>75</sup>

The problem may be identified as serious. Few ministers, for example, could provide detailed information regarding the origin of policies beyond mentioning engineers and surveyors within their respective ministries. The ones which could manage this were of the technocratic variety and included individuals such as Sheikh Ma'amoon Brifkani and Bahman Hussein (Ministers of Reconstruction & Development in Erbil and Suleimaniyah respectively). However, even these members recognise the existence of this weakness within their own ministries.<sup>76</sup> Other ministers and deputies tended not to become too involved with technical affairs but relied more on technically trained subordinates for advice relating to more technical issues.<sup>77</sup> However, the lack of comprehensive databases of information by which policies, programmes, and the distribution plan for SCR 986 could be adequately planned means that the direction of many KRG policies remains unguided, resulting in overall poor targeting of both indigenous governmental policies, and the SCR 986 programme.<sup>78</sup>

Therefore, at the level of macro-planning, the KRGs need significant support and assistance. However, once a policy has been identified, however misguided it may be, the procedures within the administrations display considerable thoroughness. Upon identification, public service programmes are developed through an initial planning procedure which exhibits a high degree of thoroughness, including the presence of feed-back loops within the system, and oversight committees on

---

<sup>75</sup> The legislation still has to be approved in Erbil due to it having to pass through the KNA. Within Suleimaniyah, Kosrat Rasoul has the authority to approve the legislation, with the support of the PUK Political Bureau.

<sup>76</sup> Interviews with Sheikh Ma'amoon Brifkani, Erbil, 20 May 1998; Bahman Hussein, Suleimaniyah, 11 July 1998.

<sup>77</sup> Interview with Falah Mustafa Bakr, Erbil, 21 May 1998.

<sup>78</sup> Certain organizations have been attempting to assist the KRGs in alleviating this problem, amongst them the Iraqi Kurdistan Research Programme (IKRP) of the University of Durham. The database created by the University of Durham-KRG programme is intended to form the starting block for the future CSO within the KRG in Suleimaniyah. Further, Nechervan Barzani has recommended to his cabinet that the distribution plan for SCR 986 should be designed in consultation with this new database, illustrating in real terms the drive of the Prime Minister in attempting to adopt an information-based decision-making process. Interviews with Nechervan Barzani, Saryrash, 22 October 2000; Dr Barham Saleh, Suleimaniyah, 3 November 2000.

technical and budgetary issues. The problem is not with the design of policies and programmes once agreed, but with the initial identification of the policy direction.

This system is sometimes short-circuited, in both administrations. Again both Prime Ministers remain open about this weakness.<sup>79</sup> For example, in an environment as economically constrained as Suleimaniyah currently is, and with perhaps the harshest socio-economic problems caused by the actions of the GOI in the 1980s and subsequently population displacement from Kirkuk, it is perhaps not too surprising that some people turn towards the PUK for assistance. The process can take the form of a direct appeal to the Prime Minister, who has continued with his weekly public audience session, or can go through the PUK hierarchy and commence with a petition to the local *Comita*. The latter route resulted in the residents of Zerinek, a collective settlement almost within the city limits of Suleimaniyah, receiving a health centre in an unusually quick time. A similar method can be seen with regard to the villagers of Sheney, who, after an audience with Talabani, benefited from the construction of a new water project by Ministry of Reconstruction & Development.<sup>80</sup>

However, in such circumstances, it could be seen that such short-circuiting and fluidity may have some benefits. Certainly with regard to Zerinek, as internally displaced peoples from Erbil and Kirkuk, the population did not have the same recourse of action to approach the Governor of Suleimaniyah, as they are not covered by his jurisdiction. The only organization they could approach was the PUK itself, particularly as it had two *Comita* within the collective.

Both cabinets state that they are striving to reduce this patrimonial-type approach to the design of programmes and policies. It is, perhaps, most notable in Erbil where the Deputy Prime Minister, Sami Abdul Rahman, instigated a removal of civil servants identified as being inefficient or corrupt up to the level of Director-General. Within Suleimaniyah, where finances are problematic, there has been less of an overt drive to reduce this characteristic.

---

<sup>79</sup> Interviews with Kosrat Rasoul, Suleimaniyah, 23 May 2000; Nechervan Barzani, Saryrash, 22 October 2000.

<sup>80</sup> The following sources are quoted with reference to the order used in Appendix 6 which displays a full catalogue of programme paperwork. The reference here refers to the number of the document in



Figure 7.4 schematicizes the planning process undertaken by the selected public service ministries identified in the case studies. Programmes start in a variety of ways, but rely heavily on the infrastructure of the executive organ in question. The initial process may involve some preliminary field investigations, negotiations with NGOs, and comparison with available data. This latter point is somewhat weakened by the fact that the KRGs suffers from a severe lack of available data due to a combination of much information being held in the counterpart ministry of the GOI, and by the sheer confusion of having a plethora of humanitarian agencies operating in the territory, each with its own data-set.

Once an initial identification of a possible programme has taken place, a provisional programme passes through the executive infrastructure, being passed through relevant planning offices of the directorates, and culminating with the General Directorate of Planning, and the relevant technical general directorate in the ministry concerned. The provisional programme may also be processed by the Governorate office, although this seems to be more probable if the initial impetus occurs either through public petition or through NGO/UN operations. The final part of this initial process is achieved when the minister and minister's bureau accepts a final proposal with which he/she then presents to the Council of Ministers for consideration.<sup>81</sup>

Once agreed within the ministry, the minister then forwards the proposal to the Council of Ministers for consideration by the planning directorate of the council, and for discussion with the other ministers. At this point, the Ministry of Finance and Economic Affairs becomes part of the official process with regard to planning the possible budget for any new programme. The programme proposal is then examined

---

the appendix, the date it was issued, and its official KRG number. Sources: MRD, Suleimaniyah, (1), Doc. Nos. 1 (1423), 30 July 1996; 2, 2 July 1996. MRD, Suleimaniyah, (4).

<sup>81</sup> MMT, Erbil, (1), Doc. Nos. 1 (2475), 26 March 1997; 3 (1639), 27 April 1997. MMT, Erbil, (2), Doc. Nos. 1 (5295), 30 December 1997; 2, 15 January 1998 (petition); 5 (302), 21 January 1998. MHSA, Erbil, (3), Doc. No. 1 (1450), 18 May 1997. MHSA, Erbil, (4), Doc. No. 2 (3598), 29 June 1997. MAI, Erbil, (5), Doc. Nos. 1 (8090), 17 November 1993; 2, 29 November 1993 (8383); 3 (6958), 1 December 1993; 4 (8547), 6 December 1993; 6 (479), 9 August 1994. MAI, Erbil, (6), Doc. Nos. 2 (204), 6 November 1996; 3, 30 November 1996. MRD, Suleimaniyah, (1), Doc. Nos. 1 (1423), 30 July 1996; 2, 2 July 1996. MRD, Suleimaniyah, (2), Doc. Nos. 1, n.d.; 3, n.d.; 8 (2603), 2 October 1997. MRD, Suleimaniyah, (3), Doc. No. 1, MHSA, Suleimaniyah, (4), Doc. Nos. 1, 5 August 1997; 2 (783), 6 August 1997; 3 (2046), 17 August 1997. MHSA, Suleimaniyah, (5), Doc. No. 1 (5880), 25 December 1996. MMT, Suleimaniyah, (6), Doc. Nos. 2, 21 July 1997; 3 (231), 26 July 1997.

**Figure 7.4: Schematic Representation of the Initial Planning Process of the KRGs**

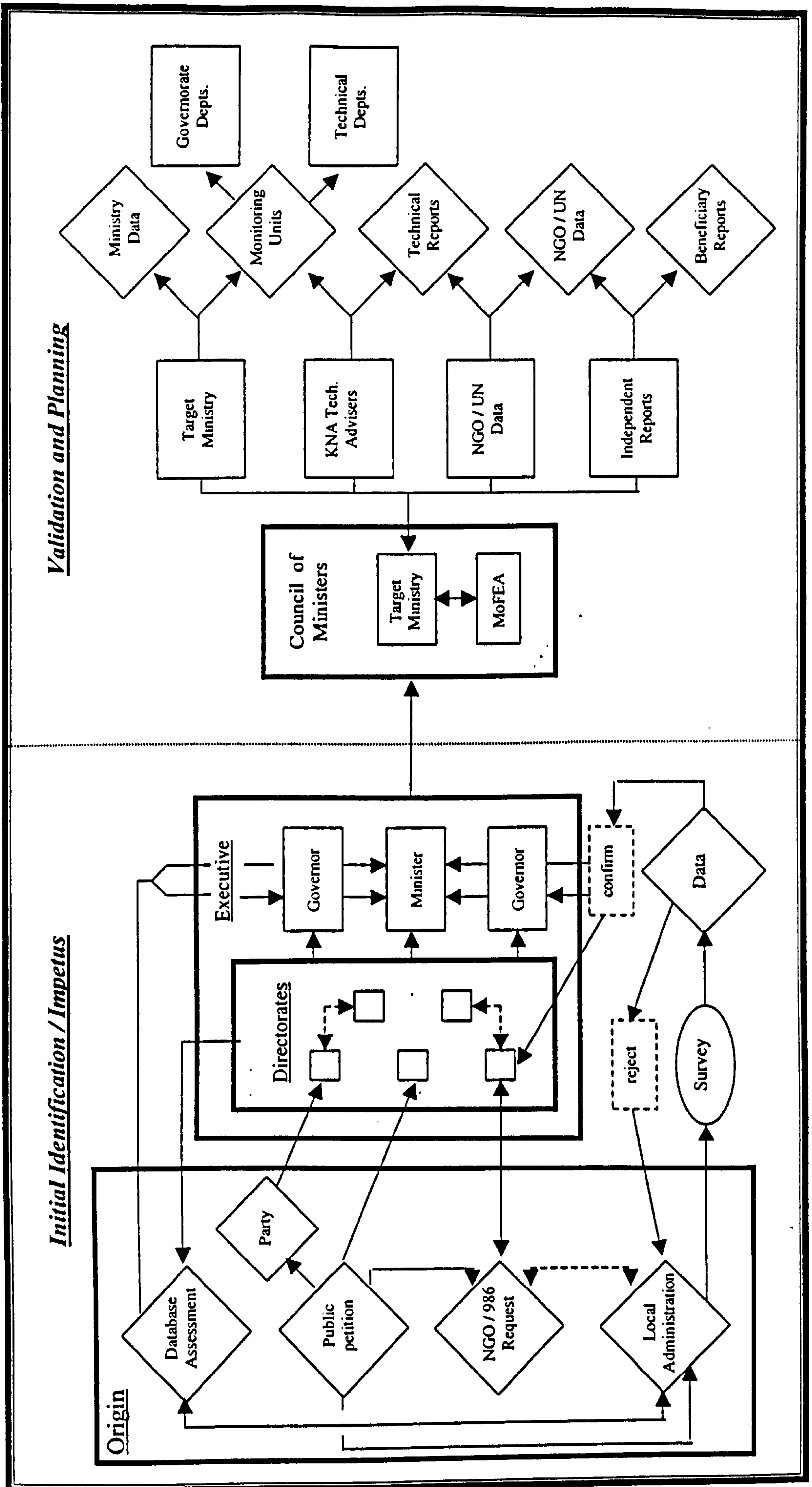



in more detail by a combination of ministry offices, technical offices of the legislative, or independent reports from consultants or international agencies.<sup>82</sup>

#### 7.5.2.2 Budgetary Planning

Perhaps the easiest aspect to investigate with regard to the operational procedures of the KRGs is how programmes within the administration are financed. Particularly during the latter stages of the third cabinet, the KDP have felt increasingly open about discussing financial issues, mainly because they are benefiting from the highly significant revenue-generating region of Ibrahim Khalil. The increases in the amount of funds being made available to the KRG in Erbil is a policy which the KDP wishes to make increasingly public, particularly as current peace initiatives emphasise the need for multi-party elections in the future. The KDP is keen to be seen to be a party which supports the administration within its territory, and is therefore quite open about the finances it allows for the KRG, if not for its own party organization or private coffers of the Barzanis.

Conversely, the PUK is reasonably open about most governmental activities, but is somewhat reticent regarding budgetary issues. It is painfully obvious that the KDP are putting far more financial reserves into the KRG in Erbil, and it is an issue which the PUK cannot hope to match. The initial response of the KRG in Suleimaniyah was to attempt to hide the figures, with the KDP subsequently being extremely forthright about its openness compared with the secrecy surrounding the finances of the KRG in Suleimaniyah. However, recently, the PUK and KRG in Suleimaniyah have been using this issue of lack of finances to their own advantage in an attempt to win favour with the US and to force the KDP into sharing revenue from Ibrahim Khalil in order to target perceived and actual differences in socio-economic standards in the region.

The impact of this difference upon the operating procedures of the two administrations has been profound. The KRG (Erbil) enjoys an extensive public sector activities programme largely funded from the coffers of the KDP. It still operates alongside UN agencies and NGOs, in particular with regard to the

---

<sup>82</sup> Sources: MMT, Erbil, (1), Doc. Nos. 3, 27 April 1997 (1639); 4, 23 June 1997 (2599). MHSA, Erbil, (3), Doc. Nos. 2, 25 May 1997 (2678). MAI, Erbil, (5), Doc. Nos. 1, 17 November 1993 (8090); 4, 4 December 1996 (328). MRD, Suleimaniyah, (1), Doc. No. 3, 30 July 1996.

implementation of SCR 986, but is not ultimately dependent on this source. However, the KRG (Suleimaniyah) is much more dependent on the revenue derived from the oil-for-food deal and NGO activities, with the result that many of its ministries are almost wholly dependent upon UN contracts and support to carry on functioning. This, at times, has created problems between UN staff and their KRG (Suleimaniyah) counterparts, as the KRG (Suleimaniyah) has attempted to exercise more control over the spending of these funds compared with their counterparts in Erbil.

Figure 7.5 illustrates the initial budgetary planning process undertaken by the selected public service ministries identified in the case studies. The initial budget preparation is somewhat interlinked with the initial identification of the programme, and it is the lower levels of the administrative structure which undertakes this preliminary work. At this level, it is apparent that there are significant cross-linkages between different directorates and departments of different ministries and governorate offices, particularly with regard to planning the sharing of equipment and pooling of resources. Within Suleimaniyah, there is also a significant element of approaching NGOs for additional funding for programmes. The provisional budget planning is an element of the preliminary survey procedure, and feed-back loops can be identified within the system if the local office considers the budget to be unacceptable.<sup>83</sup>

Once agreed, the budget is passed either through the ministerial structure, or, more unusually, directly to the counterpart planning office within the Ministry of Finance and Economic Affairs. The budget is discussed alongside the programme plans by the Council as a whole, and then between the technical departments of the ministry concerned and the Ministry of Finance and Economic Affairs. The budget is then either accepted or rejected. If rejected, the programme could either be scrapped or suspended, but more likely to be re-budgeted by the department which constructed

---

<sup>83</sup> Sources: MMT, Erbil, (1), Doc. No. 2, 23 April 1997. MMT, Erbil, (2), Doc. No. 1 (5295), 30 December 1997; 5 (302), 21 January 1998. MHSA, Erbil, (3), Doc. No. 1 (1450), 18 May 1997. MAI, Erbil, (5), Doc. No. 2 (8383), 29 November 1993; 3 (6958), 1 December 1993; 6 (479), 9 August 1994. MAI, Erbil, (6), Doc. No. 5 (346) 23 December 1996. MRD, Suleimaniyah, (1), Doc. Nos. 1 (1423), 30 July 1996; 2, 2 July 1996. MHSA, Suleimaniyah, (4), Doc. No. 3 (2046), 6 August 1997. MHSA, Suleimaniyah, (5), Doc. No. 1 (5880), 25 December 1996. MMT, Suleimaniyah, (6), Doc. No. 4, 26 July 1997. MAI, Suleimaniyah, (7), Doc. No. 1 (480), 5 April 1997.



**Figure 7.5: Schematic Representation of the Budgetary Planning of the KRGs**

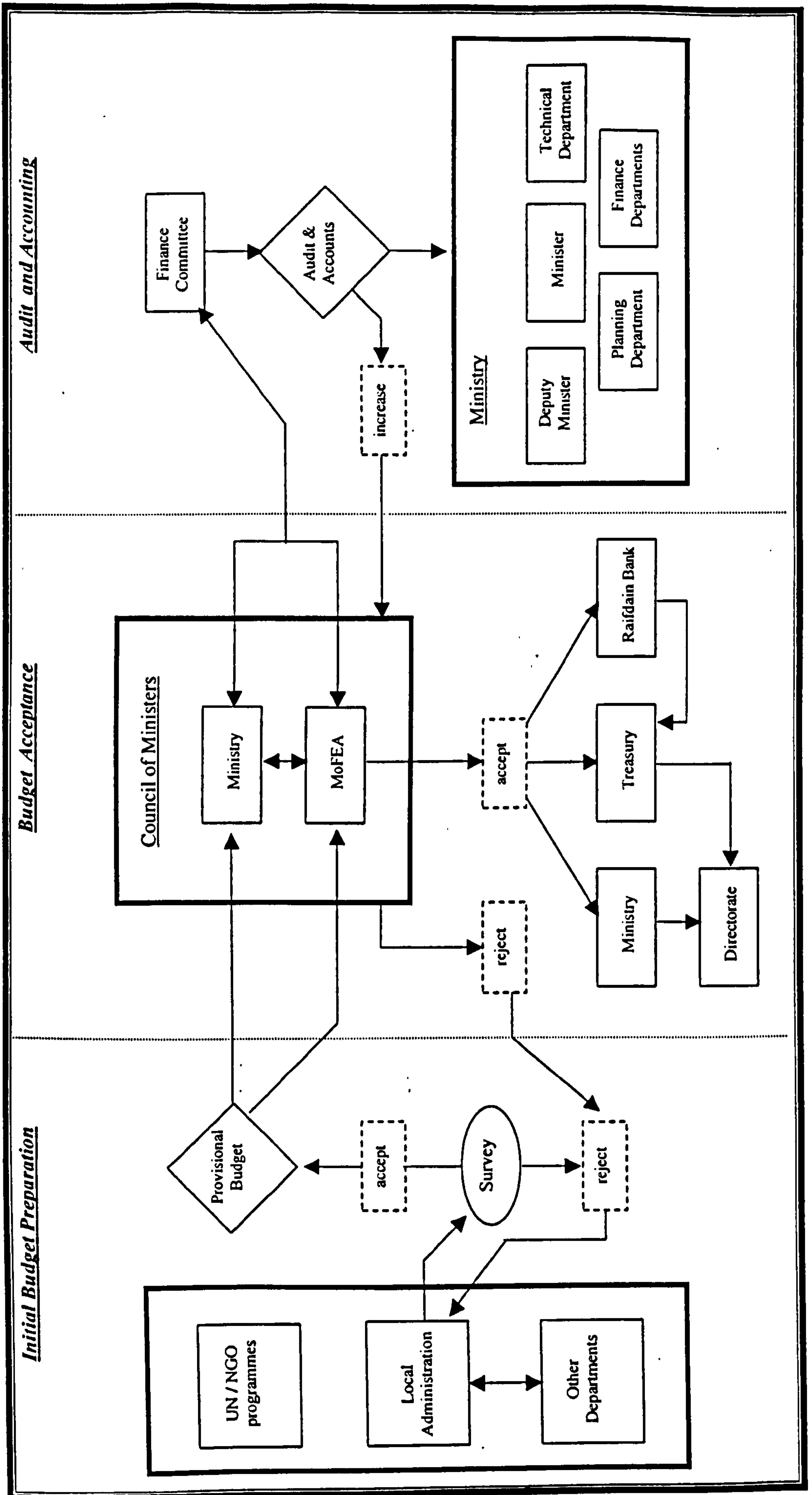

the original proposal. If accepted, the Ministry of Finance and Economic Affairs notifies the ministry concerned that the agreed funds have been released, and informs the Governorate Treasury (where the work is planned to take place) to release the required sum either from the agreed account of the ministry in question, or from emergency funds specially designated by the Council of Ministers.<sup>84</sup>

To oversee the programme spending and expenditure, a Finance Committee is established jointly between the sectoral ministry and the Ministry of Finance and Economic Affairs. The reports of this committee are returned to the Council of Ministers, the target ministry, and the Ministry of Finance and Economic Affairs. The directorates of the sectoral ministry itself addresses any problems highlighted by the audit, and necessary increases are forwarded to the Council of Ministers, which are then addressed through the same procedures. It is apparent that the KRG (Suleimaniyah) operates a much less obvious system of financial regulation, almost certainly due to the fact that the majority of revenue which passes through its system is budgeted and audited externally by UN agencies and NGOs.<sup>85</sup>

### 7.5.2.3 The Implementation Process

The process of converting the plans and budget for governmental programmes to actual improvements in the physical fabric and/or living conditions of the society is initially easy to follow with a definite output at the end to measure against the requirements of the original programme. However, it is necessary to understand this process from within the administrative infrastructure, which includes analysing the

<sup>84</sup> Sources: MMT, Erbil, (1), Doc. Nos. 3 (1639), 27 April 1997; 4 (2599), 23 June 1997; 5 (3749), 6 July 1997; 6 (537), 6 July 1997; 7 (3186), 12 July 1997; MMT, Erbil, (2), Doc. Nos. 1 (5295), 30 December 1997; 9 (353), 9 February 1998; 14 (937), 24 February 1998; 15 (1342), 24 March 1998. MHSA, Erbil, (3), Doc. Nos. 1 (1450), 18 May 1997; 2 (2678), 25 May 1997; 3 (2464), 12 June 1997; 4 (3437), 23 June 1997. MHSA, Erbil, (4), Doc. Nos. 1 (2544), 15 June 1997; 2 (3598), 29 June 1997; 3 (2201), 17 July 1997. MAI, Erbil, (5), Doc. Nos. 14, 23 May 1997; 17 (3252), 2 August 1997; 18 (4957), 25 August 1997. MAI, Erbil, (6), Doc. Nos. 5 (346), 23 December 1996; 6 (1752), 29 December 1996; 7 (32), 7 January 1997; 9 (273), 20 January 1997; 14 (23), 1 July 1997; 25 (1296), 29 September 1997; 33 (1477), 27 October 1997. MRD, Suleimaniyah, (1), Doc. Nos. 12 (1130), 17 November 1997; 15 (1230), 17 December 1997. MRD, Suleimaniyah, (2), Doc. Nos. 4 (692), 16 August 1997; 5 (1734), 19 August 1997; 6 (4611), 23 August 1997. MHSA, Suleimaniyah (4), Doc. No. 4 (4671), 25 August 1997.

<sup>85</sup> Sources: MMT, Erbil, (1), Doc. Nos. 10 (2671), 7 August 1997; 12 (4023), 25 August 1997; 13 (4123), 28 August 1997; 14 (4192), 3 September 1997; 15, 23 November 1997. MMT, Erbil, (2), Doc. No. 13 (685), 14 February 1998. MHSA, Erbil, (3), Doc. No. 6 (4294), 31 July 1997. MHSA, Erbil, (4), Doc. No. 5 (220), 2 September 1997. MAI, Erbil, (6), Doc. Nos. 8 (207), 20 January 1997; 9 (273), 20 January 1997; 35 (1564), 10 November 1997. MMT, Suleimaniyah, (6), Doc. No. 6 (5739), 19 August 1997.



mechanisms by which the local authorities implement a policy/programme (whether by their own directorates / departments and staff, contracting out to private firms, or seeking the assistance of NGOs, for example), how the programme is assessed throughout the implementation period, and possible quality control procedures which may be taken.

Figure 7.6 illustrates the generic implementation process. Once the budget and programme plan has been accepted by the ministry concerned, then the Council of Ministers and Ministry of Finance and Economic Affairs, the ministry concerned and the Ministry of Finance and Economic Affairs forms a committee to oversee the implementation of the proposed programme, working alongside the equivalent audit committees. This committee is then responsible for identifying technical staff with the ministry and directorates, including those within governorate offices, and negotiating with local private contractors if expertise is required outside the regular capabilities of the ministerial structures. During and after implementation, the work is assessed by the implementation committee, and/or by bodies headed by the minister or deputy for particularly high profile programmes. In addition to this set of procedures, the KRGs are often asked to receive programmes started by NGOs or UN agencies. In such cases, the KRGs have usually been involved with the programme, normally during the implementation phase. The programmes implementation process studied of this type suggest that the KRG shadows the different phases of implementation and covers some of the costs of the programme. However, the later success of this enterprise in particular suffered apparently due to a lack of coordination between the administration and NGO concerned.<sup>86</sup>

---

<sup>86</sup> Sources: MMT, Erbil, (1), Doc. Nos. 8 (3284), 20 July 1997; 11 (2708), 12 August 1997; 17, 3 November 1997; 18 (5500), 4 November 1997; 19 (5511), 4 November 1997. MMT, Erbil, (2), Doc. Nos. 13 (685), 14 February 1998; 16 (853), 28 March 1998; 17, 28 March 1998. MHSA, Erbil, (2), Doc. Nos. 5 (2321), 26 July 1997; 6 (4294), 31 July 1997; 7 (1330), 25 October 1997; 8 (7013), 16 November 1997. MHSA, Erbil, (2), Doc. Nos. 5 (220), 2 September 1997; 7 (398), 30 December 1997. MAI, Erbil, (1), Doc. Nos. 7 (1579), 23 April 1997; 8 (383), 28 April 1997; 9 (389), 3 May 1997; 12 (345), 12 May 1997; 14, 23 May 1997; 16 (648), 3 July 1997. MAI, Erbil, (1), Doc. Nos. 11 (502), 17 February 1997; 12 (239), 29 June 1997; 13 (40), 30 June 1997; 17 (837), 5 July 1997; 26 (1303), 1 October 1997; 29, 13 October 1997; 32, (1396), 15 October 1997. MRD, Suleimaniyah, (1), Doc. No. 13 (3371), 9 December 1997. MRD, Suleimaniyah, (2), Doc. Nos. 9 (57), 10 November 1997; 10 (3407), 10 November 1997. MRD Suleimaniyah, (3), Doc. Nos. 2 (1206), 13 May 1997; 4 (1344), 31 May 1997; 8 (1536), 25 June 1997. MMT (Suleimaniyah), (6), Doc. No. 6 (5739), 19 August 1998.

Figure 7.6: The Implementation Process of the KRGs

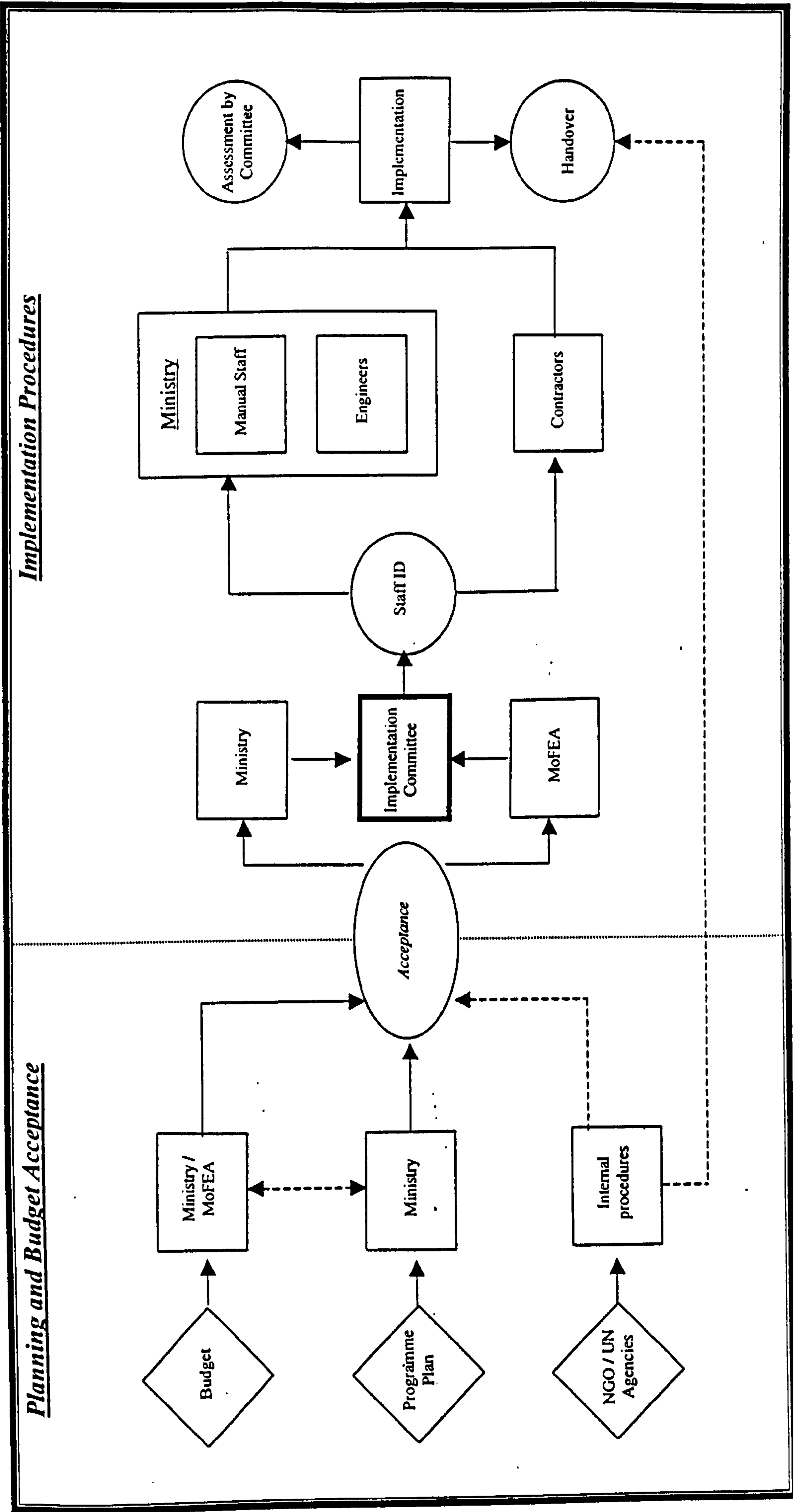



### 7.5.3 Conclusion

The decision-making process of the KRGs may be described as operating along identical precepts in both Erbil and Suleimaniyah, with its institutions and prescribed tenets governing the process rather than individuals. This largely disagrees with most analyses of Kurdish politics which see the political arena of the region being largely character-driven. Whilst this may be true in the party political sphere, within the administrative sphere, governmental officials do attempt to work as such rather than as individual politicians. There are some notable exceptions. Kosrat Rasoul has undoubtedly stamped his own personality on the KRG (Suleimaniyah), as has Nechervan Barzani in Erbil. However, the decision-making process of these administrations displays a significant degree of order, cohesion, and a limited but increasing amount of accountability.

Differences in the decision-making process between the administrations of Erbil and Suleimaniyah are apparent. Within Suleimaniyah, the more fluid process of administration and the closeness of the PUK with the KRG are reflections of the financial constraints effecting Suleimaniyah and Darbandikhan caused by geopolitical and geo-economic disadvantages. This has resulted in a system which has had to adapt to targeting specific areas and sectors of hardship with the assistance of the PUK's party system to identify problems. Within Erbil, the KRG benefits from a significantly more substantial, if still fragile, income derived from the KDP customs points at Ibrahim Khalil. The effect of this has been to increasingly allow the KDP to separate itself from the KRG, and for the KRG to be less dependent upon UN agencies and NGO programmes.

However, both administrations exhibit serious weaknesses in terms of the ability to plan for the longer term, primarily due to a shortage of data and the fact that there is no Ministry of Planning or formalised planning institution within either structure. These problems are compounded by the fact that the implementation of the oil-for-food deal (SCR 986) encourages little forethought in planning and UN agencies simply require the local authorities to provide them with 'shopping lists', which are then submitted to the GOI as part of the distribution plan. The result of these dynamics is two administrations which are characterised by inefficiency and, at times, a lack of professionalism. There are increasing moves to rectify these

problems, with Kosrat Rasoul heading an initiative to centralise all ministerial planning departments, and with Sami Abdul Rahman investigating the possibilities of establishing a central planning authority, but such institutions would be dependent upon enduring political stability and the normalization of revenue inputs.<sup>87</sup> Furthermore, the establishment of a planning authority may indicate the reinforcement of a longer-term development plan for the Iraqi Kurdish region, which would create consternation in the neighbouring capitals.

## 7.6 Conclusion

The KRG has developed from being a unified organization at the beginning of the 1990s to being divided into two separate systems 10 years later. However, rather than strength existing in unity, the opposite has proved to be the case. The joint system of the first and second cabinets brought together two political parties which are separated by the quest for power. To have them together in a power sharing situation worsened this rivalry. Furthermore, the joint system concerned neighbouring states, and not least the GOI, that the *de facto* state also possessed a structure of governance which had the potential, on paper, to promote the Kurdish national movement in a unified manner. This was highly unappealing for Turkey and Iran, as well as for Iraq itself.

The result of the collapse into conflict in 1994 was a direct manifestation of this pair of internal and external stresses and strains. Subsequently, the divided system which emerged in the summer of 1996 has allowed the KDP and PUK to govern the region without the same aspects of internal competition, and without the same problems occurring through the antagonising of neighbours. However, geopolitical positioning has created an uneven input of revenue into the two systems, and a different set of international responses towards the two areas, resulting in the KRGs of Erbil and Suleimaniyah exhibiting different relationships with regard to the dominant political party.

These problems have made the task of administering Iraqi Kurdistan somewhat difficult. The KRGs are currently enjoying their longest period of administration

---

<sup>87</sup> Interviews with Nawshirwan Mustafa, Suleimaniyah, 10 August 1999; Sami Abdul Rahman, 2



without being overturned by the impact of interfactional fighting, and have at last been able to target increasingly the populace of the region. This fact has certainly not been lost on astute observers. Aziz Mohammad, the highly respected ex-leader of the KSP observed that *“the KRG has had some successes, but it should be realised that it has been in existence for nearly a generation. What it has achieved is simply not enough.”*<sup>88</sup>

Whether the root of the problem of this lack of achievement may be found within the KDP and PUK, or in the actions of neighbouring states is an interesting point of debate. However, it is apparent that the longer there is stability in Iraqi Kurdistan, the more successful the KRGs will become. Jalal Talabani, who is quite open about the inefficiencies of the KRG, blames both sets of dynamics for unsettling the business of administration, but still believes the KRG to be successful, and particularly since 1996: *“Despite regional hostility and regrettable internal conflict, our fledgling administration has proven remarkably successful.”*<sup>89</sup>

The sentiments of Massoud Barzani prove to be similar. In a response to questions regarding the performance of the KRG, he stated that:

*“As far as services go, there is no doubt that so far its [the KRG] performance is less than what we aspire for. However, to be fair, we have to observe with appreciation the continuing and rapid development . . . . the important thing is that we have a strong political and practical will to provide the people with a safe life and good services.”*<sup>90</sup>

Current initiatives to bring the two regions back under a unified administration should be thought through both with the lessons of history, and an understanding of the operating procedures of the KRGs, kept in mind. There is a definite yearning for a unified administration, at least in public, from both the KDP and PUK.<sup>91</sup> However, the question has to be asked as to whether the parties truly want this, and, perhaps more importantly, is it beneficial in the longer term? Jalal Talabani has been quoted

---

February 2000.

<sup>88</sup> Interview with Aziz Mohammad, Erbil, 19 August 1999.

<sup>89</sup> Speech of Jalal Talabani, 9 November 1999, to Plenary Session of the 2first Congress of the Socialist International in Paris.

<sup>90</sup> *Al-Zaman*, newspaper, 26 October 2000, *Barzani Interview*, by Sa'd al-Bazzaz.

<sup>91</sup> Interviews with Nawshirwan Mustafa Amin, Suleimaniyah, 10 August 1999; Sami Abdul Rahman, Salahadin, 29 August 1999.

as offering the premiership of a new joint cabinet to Nechervan Barzani, but to achieve this, elections will have to take place and the KDP and PUK will have to normalize relations with each other to a much greater degree than is currently being undertaken. Furthermore, each side appears to be reinforcing its ties to the KRG in its own area, with the KDP forming the new fourth cabinet under the leadership of Nechervan, and the PUK undertaking local elections, in which it won a handsome majority. It is extremely difficult firstly to imagine these two parties putting into action their intentions to unify, and even more difficult to imagine them mutually accepting a system which would have one party in government, the other in opposition. Aziz Mohammad again noted that:

*“Our leadership does not want unity and they do everything to be separate. They may say that they want unity, but the manner in which they want it makes it mutually unacceptable. The leadership of the PUK and KDP wants full control of any unified body. Neither party wants to be the second party in opposition.”<sup>92</sup>*

Perhaps in the longer term, Iraqi Kurdistan will again benefit from the establishment of a unified system of governance. However, in the shorter term, if history is to be a guide, it is difficult to envisage a more damaging solution to the Kurdish problem in Iraq, particularly when the current divided system has shown itself to be reasonably successful at maintaining some semblance of peace and stability in a region more used to violence and political instability.

---

<sup>92</sup> Interview with Aziz Mohammad, Erbil, 19 August 1999.



## Chapter Eight

### Conclusion

Iraqi Kurdistan may be characterised as a small, land-locked entity which exists in one of the most geopolitically tense of regions. As well as suffering from serious external geopolitical pressures caused by the national interests of neighbouring states, the Iraqi Kurds also have serious internal problems, with the Iraqi Kurdish political system possessing parties which are often in conflict with each other (and, indeed, with themselves) and display deep-rooted antipathies which have all too often resulted in a decline into conflict. The problem which this thesis has sought to address is to identify a model for the continued peaceful political development of the Iraqi Kurdish region, taking into account both external and internal parameters, ensuring a continued and effective administration.

After nearly ten years of existing without the direct interference of the central GOI, the people of Iraqi Kurdistan may now be realising the beginnings of the establishment of a stable, indigenous, system of government with aspirations of democratic ideals and tendencies if not, as yet, realities. Whether by design or accident, the political and administrative system of the region has developed into a structure which displays a modicum of stability, albeit through a cumbersome division of power and inefficient administrative structure, and limited multi-party involvement. The characteristics of the political system can be seen to have its roots in the decades of political development before the 1990s, and, possibly, in the inherent qualities of the peoples of Iraqi Kurdistan. In turn, the characteristics of the administrative system have been shown to be influenced greatly by the party political system and its internal dynamics, combined with the functional need of administering a region in a geopolitical flashpoint.

Particularly since 1991, the major political parties of the KDP and PUK have been forced to acknowledge the necessity to encourage more democratic procedures and actions in order to gain the support of the international community for their plight. This is combined with the need for the party leaders to preserve their own power

base, both within the party and within the region at large. There is therefore a delicate balance in existence between the need to be seen to be promoting democratic, civil ideals, and undertaking those measures which will preserve the current levels of elite accommodation.

The system which, in my opinion, was inadvertently stumbled upon in the aftermath of the ferocious fighting of 1994-1995, and the subsequent invasion of Erbil by the KDP supported by the GOI in August 1996, can be seen to satisfy many of the requirements of promoting the development of the administrative system and civil society, along with the preservation of power by creating a geographic variant of a consociational political and administrative system, with the main protagonists, the KDP and PUK, being divided between Erbil and Suleimaniyah. The development of the separate administrations has not been straightforward, with political considerations haunting many of the actions of both administrations. However, and especially since 1999, the increasing efficiency of both administrations is apparent, with technocrats appearing at many high levels, and with political motivators of both parties dominating the direction taken by the administrations, with Nechervan Barzani and Sami Abdul Rahman in Erbil, and Jalal Talabani, Kosrat Rasoul and, increasingly, Nawshirwan Mustafa in Suleimaniyah.

The impact of the UN SCR 986 series of resolutions on the development of the administration has been immense. They have, in effect, taken a great task away from the fledgling administrations by ensuring that the population of the region is fed and is provided with basic provisions. This has freed considerable resources for the KRGs. The oil-for-food programme has also supported the administrations in a technical sense, with UN agencies being forced to assist and collaborate with the offices of the Kurdish 'local authorities' (the UN is unable to call them collectively the KRG due to its relation with the GOI) and implement large-scale humanitarian projects through the relevant technical ministry, thereby supporting its staff and activities. This is a particularly welcome dynamic for the PUK-dominated administration, which does not enjoy the same internal revenue as the KDP-dominated administration.



The current interpretation and hoped implementation of the Washington Agreement of 1998, which is attempting to draw both of these parties together is, in effect, ignoring this delicate balance which has been achieved by the Kurds themselves, and could, in fact, produce a critical mass of bitterly opposed politicians in the capital city of Erbil. This is highly unfortunate, as the Washington Agreement offers many possibilities, with elections only being one of many. Both political parties contend that, if the current situation continues, then elections should occur. However, I contend that more time is needed to ensure that the administrations are increasingly secure in terms of separation from the dominant political party, that problems over internal revenues are resolved, and that the major parties themselves are given the opportunity to resolve their own internal tensions. The PUK in particular has serious internal stresses which have to be resolved regarding the leadership structure of the party. Within the KDP, the current major destabilising issue is centred upon the management of the KDP's relationship with the PUK and other smaller parties, including the Islamist groups. Furthermore, the union of the KDP and PUK in Erbil within a recognisable coalition government has failed previously, and the neighbouring powers, notably Iraq, Iran and Turkey, have consistently displayed their desire and ability to destabilise such an initiative. Again, time is needed to resolve these volatile issues. However, the reunion of the administration, and the political system, at this time would endanger the progress made particularly since 1996.

The problems of unification can be traced to internal political and external geopolitical reasons. With regard to those problems of internal politics, the KDP and PUK still portray inherent differences in their respective approach to politics and the resolution of the Kurdish issue. The PUK is still the most radical of the two parties, particularly with regard to its off-on relationships with the central GOI and with Iran, and the KDP has consistently showed its ability to resort to any measure in order to preserve its political and military position within the region, and particularly against the PUK. Furthermore, the different political styles of the parties which have been a common feature in the analyses of Kurdish political history are still apparent. The position of the Barzanis in the KDP is still predominant, although I disagree with those who consider Massoud to be tribal dictator over those persons who have received his patronage. Similarly, the criticisms often thrown at the PUK, including

their apparently chaotic decision-making process, are often valid, but one should be aware of the political development and history of the organization, and that what may be occurring is a Kurdish approach to collective decision-making, rather than mob-rule, as is often assumed to be the case. However, the existence of these fundamental differences certainly make it more problematic to bring together the two organizations into a cooperative, and trustful, arrangement of governance.

With regard to the geopolitical involvement of foreign powers, Iraqi Kurdistan may be seen to be increasingly the geopolitical centre of the Middle East. With the tension between Iran and Turkey remaining high, these states continue to play out their rivalries through their proxies in Iraqi Kurdistan, which are currently the KDP for Turkey and the PUK for Iran, although these allegiances are rarely stable. Obviously, Iraq is heavily involved in the affairs of the region, as are a host of other Middle Eastern and foreign powers. The Iraqi Kurdish region in particular has the ability to act as a pivotal region in the Middle East, with the ability to impact upon the affairs of several countries. The key to this geopolitical dynamic remains the domestic instability of Iraqi Kurdistan. As far as neighbouring states in particular are concerned, the existence of a unified, democratically elected government in Iraqi Kurdistan is proof of an increasingly stable, institutionalised Iraqi Kurdistan. This is reason enough for them to actively promote the destabilization of the region, as happened in 1994 and 1996, particularly as these states fear that Iraqi Kurdish democratic successes may attract the attention of states such as the US which may support the increased development of such a government. The result, therefore, in 1994 was a concerted effort by neighbouring states to divide the unified government in any way politically or militarily possible.

The solution to this problem, as seen in the evidence supplied in this thesis, is to therefore keep the administrative and political system, in the short-term, divided. Such a division is beneficial for several reasons, but perhaps, most significantly, it removes the overt legitimacy of the indigenous government, thereby quelling the anxiety of neighbouring states, reducing the supposed need for them to become involved in the destabilization of the Iraqi Kurdish region. The division also allows the two major parties of the KDP and PUK to resolve their differences whilst preserving their own power bases in the short-term.



As stated earlier, the Washington Agreement offers many possibilities, with elections only being one. It is apparent that the tenets of the agreement acknowledge these dangerous dynamics and do allow for a progressive rapprochement to take place. However, in my field experience, it is apparent that many parties see the issue of elections as the overriding concern, and it would be a difficult task to encourage the gradual promotion of a unified political system, both to the Iraqi Kurdish population in general, and the political parties in particular.

It is therefore forwarded that such increased unification could be achieved in a more technically orientated manner, under a consociational approach of elite accommodation, with the focus being more on the coordination of the activities of the separated local authorities, rather than on more public grand political statements involving elections. Currently, the Iraqi Kurdish region is tense, but enjoying its third year without serious internal fighting. This, in my opinion, is a function of the geographic-consociational system apparent since 1996 in particular, and it is within this system that a more peaceful political development may be found.

As has been seen, Iraqi Kurdistan may be characterised as being a laboratory for theories of political science and international relations. Its position at the centre of the geopolitical conundrum of the Middle East has resulted in its continuing precarious political development. The problem of internal political rivalries combined with external geopolitical agendas has meant that the Kurds remain the largest nation without a state. This may not change. However, the people of Iraqi Kurdistan will only enjoy stability and freedom from conflict, whether in their own state or within the confines of others, once their politicians and states supposedly supportive to their cause pursue a route which acknowledges that a balance has to be achieved between the internal needs and external forces affecting this tragic region.

## Appendix 1: Population Statistics

### Population Figures for Rural Areas and Collective Settlements

**Table A1:1 Rural Population Figures: Erbil Governorate<sup>1</sup>**

Name of Qaza	Name of Nahiya	No. of villages	Total population	Population under 5 years	Population under 5 years %
<b>Zebar</b>	Sherwanmazin	23	3555	544	15
	Barzan	26	6329	791	12
	Mergasur	73	10474	1640	16
	<b>TOTAL</b>	<b>122</b>	<b>20358</b>	<b>2975</b>	<b>15</b>
<b>Soran</b>	Sidakan	127	11775	2003	17
	Khalifan	63	19430	3351	17
	Diana	40	18830	2768	15
	Rawanduz	44	11428	1560	14
	<b>TOTAL</b>	<b>274</b>	<b>61463</b>	<b>9682</b>	<b>16</b>
<b>Choman</b>	Hajiomaran	16	4397	691	16
	Galala	88	24481	4337	18
	<b>TOTAL</b>	<b>104</b>	<b>28878</b>	<b>5028</b>	<b>17</b>
<b>Shaqlawā</b>	Hareer	70	17364	2734	16
	Salahaddin	77	20461	3337	16
	Hiran	32	8169	1324	16
	<b>TOTAL</b>	<b>179</b>	<b>45994</b>	<b>7395</b>	<b>16</b>
<b>Erbil district</b>	Khabat	36	18241	4426	24
	Ainkawa	62	27028	5014	19
	Qushtapa	52	7385	1272	17
	<b>TOTAL</b>	<b>150</b>	<b>52654</b>	<b>10712</b>	<b>20</b>
<b>Koisenjaq</b>	Koisenjaq c.	46	8971	1629	18
	Shorish	32	4539	693	15
	Taq Taq	49	14818	2936	20
	<b>TOTAL</b>	<b>127</b>	<b>28328</b>	<b>5258</b>	<b>19</b>
<b>TOTAL</b>		<b>956</b>	<b>237,675</b>	<b>41,050</b>	<b>17</b>

<sup>1</sup> Source: Figures from Ministry of Reconstruction and Development (Kurdistan Regional Government) Village Survey 1997 (Erbil).



**Table A1:2 Rural Population Figures: Dohuk Governorate<sup>2</sup>**

Name of Qaza	Name of Nahiya	No. of villages	Total population	Population under 5 years	Population under 5 years %
<b>Zakho</b>	Sendy	2	656	97	15
	Rezgary	19	3164	645	20
	Gully	35	3679	645	18
	<b>TOTAL</b>	<b>56</b>	<b>7499</b>	<b>1387</b>	<b>18</b>
<b>Ameady</b>	Barwary	58	16013	2590	16
	Nerwa Rekan	33	6850	1459	21
	Ameady	15	3085	442	14
	Sarsenk	84	15906	2846	19
	<b>TOTAL</b>	<b>190</b>	<b>41854</b>	<b>7337</b>	<b>18</b>
<b>Sumail</b>	Sulaivany	28	3591	745	21
	Sumail	27	5902	1026	17
	<b>TOTAL</b>	<b>55</b>	<b>9493</b>	<b>1771</b>	<b>19</b>
<b>Dohuk district</b>	Dosky	41	8531	1266	15
	Zawita	46	5317	764	14
	Dohuk c.	7	14860	2787	19
	<b>TOTAL</b>	<b>94</b>	<b>28708</b>	<b>4817</b>	<b>17</b>
<b>Shekhan</b>	Atrosh	39	5277	850	16
	Qasrok	58	11048	1930	17
	<b>TOTAL</b>	<b>97</b>	<b>16325</b>	<b>2780</b>	<b>17</b>
<b>Akrea</b>	Nahla	72	16507	2754	17
	Akrea	16	8663	1485	17
	Bardarash	79	47564	9190	19
	Gerdaseen	93	31225	5621	18
	Sorchy	43	9832	2022	21
	<b>TOTAL</b>	<b>303</b>	<b>113791</b>	<b>21072</b>	<b>19</b>
<b>TOTAL</b>		<b>795</b>	<b>217670</b>	<b>39164</b>	<b>18</b>

<sup>2</sup> Source: Figures from Ministry of Reconstruction and Development (Kurdistan Regional Government) Village Survey 1997 (Erbil).

**Table A1:3 Rural Population Figures: Suleimaniyah Governorate<sup>3</sup>**

Name of Qaza	Name of Nahiya	No. of villages	Total population	Population under 5 years	Population under 5 years %
Ranyah	Chwarqurna	68	18828	3121	17
	Betwata	27	10945	2249	21
	<b>TOTAL</b>	<b>95</b>	<b>29773</b>	<b>5370</b>	<b>18</b>
Qaladiza	Pishdar Centre	92	23528	3731	16
	Hero	103	28694	4416	15
	<b>TOTAL</b>	<b>195</b>	<b>52222</b>	<b>8147</b>	<b>16</b>
Dokan	Chinaran	33	8509	1528	18
	Bingird	46	8380	1412	17
	Surdash	73	13053	1709	13
	<b>TOTAL</b>	<b>152</b>	<b>29942</b>	<b>4649</b>	<b>16</b>
Chwarta	Seewail	66	7958	1000	13
	Mawat	86	14212	1811	13
	Sruchik	53	10009	1439	14
	Chwarta	96	13206	1837	14
	<b>TOTAL</b>	<b>301</b>	<b>45385</b>	<b>6087</b>	<b>13</b>
Penjween	Penjween	58	11390	2169	19
	Garmik	76	14672	2097	14
	<b>TOTAL</b>	<b>134</b>	<b>26062</b>	<b>4266</b>	<b>16</b>
Sulei. District	Arbat	57	7537	1342	18
	Bazian	30	4506	747	17
	Sarchinar	74	9295	1391	15
	Qaradagh	83	11395	1617	14
	<b>TOTAL</b>	<b>244</b>	<b>32733</b>	<b>5097</b>	<b>16</b>
Halabja	Khurmali	38	10259	1655	16
	Saidsadiq	47	22038	3192	14
	Biara	24	5832	806	14
	Seerwan	82	11675	2010	17
	<b>TOTAL</b>	<b>191</b>	<b>49804</b>	<b>7633</b>	<b>15</b>
<b>TOTAL</b>		<b>1,302</b>	<b>265,921</b>	<b>41,249</b>	<b>16</b>

<sup>3</sup> Source: Figures from Directorate of Reconstruction (Ministry of Reconstruction and Development, Kurdistan Regional Government (Suleimaniyah)) Village Survey 1997.



**Table A1:4 Rural Population Figures: Darbandikhan Governorate<sup>4</sup>**

Name of Qaza	Name of Nahiya	No. of villages	Total population	Population under 5 years	Population under 5 years %
Chamchamal	Aghalar	62	11562	1836	16
	Chamchamal	52	6175	1010	16
	Sangaw	92	8927	1111	12
	Qadir Karam	27	2972	458	15
	Showan	27	6255	1056	17
	<b>TOTAL</b>	<b>260</b>	<b>35891</b>	<b>5471</b>	<b>15</b>
Darbandikhan	Zaraen	34	4785	953	20
	Darbandikhan	24	6213	703	11
	<b>TOTAL</b>	<b>58</b>	<b>10998</b>	<b>1656</b>	<b>15</b>
Kalar	Maidan	41	9941	1651	17
	Qurato	40	5520	854	15
	Tilako	82	9750	1530	16
	Pebaz	74	9559	1683	18
	Kalar	24	9743	1464	15
	<b>TOTAL</b>	<b>261</b>	<b>44513</b>	<b>7182</b>	<b>16</b>
Kifri	Sarqala	35	4981	926	19
	Nawjul	22	2426	379	16
	<b>TOTAL</b>	<b>57</b>	<b>7407</b>	<b>1305</b>	<b>18</b>
<b>TOTAL</b>		<b>636</b>	<b>98,809</b>	<b>15,604</b>	<b>16</b>

**Table A1:5 Collective Settlement Population Figures: Erbil Governorate<sup>5</sup>**

Settlement Name	Year of Construction	Predominant Tribe(s) Relocated in the Collective Settlement	Total Population of Settlement
Diana	1978	Balakayati, Bradost, Gardi, Barzani, Muhajir	10573
Galala	1981	Balakayati	4044
Hareer	1978	Mzury, Sherwany, Balakayati	7280
Basirma	1988	Harky, Alana, Khoshnaw, Khailany, Rost, Balakayati	5613
Bastora	1977	Surchy, Goran, Khoshnaw, Balakayati	6114
Tobzawa	1987	Shamamk, Shwan, Salay, Qaraj, Kandinawa, Shekhubzeny	16500

<sup>4</sup> Source: Figures from Directorate of Reconstruction (Ministry of Reconstruction and Development, Kurdistan Regional Government (Suleimaniyah)) Village Survey 1997.

<sup>5</sup> Source: Durham University Policy Planning Unit, Collective Settlement Survey, Summer 1998, in collaboration with Ministry of Reconstruction and Development (Erbil) and Directorate of Statistics (Suleimaniyah).

<b>Kawr Gosik</b>	1987	Surchy, Qaraj, Shamamk, Qaladiza	<b>10000</b>
<b>New Khabat</b>	1988	Sian, Gardy, Galaly, Nanakaly, Kakay	<b>5200</b>
<b>Shakholan</b>	1990	Mizury, Harky, Binjy, Sherwany	<b>2843</b>
<b>Kani Qirjala</b>	1974	Surchy, Akraea, Goran, Harky	<b>2793</b>
<b>Sebeeran</b>	1977	Balak, Baradosty, Sherwany, Harky	<b>2300</b>
<b>Jideeda Zab</b>	1987	Qaladizi, Salay, Shekhabzeny	<b>2000</b>
<b>Barhushtir</b>	1989	Shwan, Akraea, Sharazur, Qaladiza	<b>210</b>
<b>Bahirka</b>	1978	Barzany, Harky, Baradost	<b>6400</b>
<b>Shawes</b>	1977	Khoshnaw, Balakayati, Goran	<b>6000</b>
<b>Mala Omer</b>	1979	Khoshnaw, Balakayati	<b>4587</b>
<b>Peerzin</b>	1977	Khoshnaw, Balakayati	<b>4533</b>
<b>Jazhnikan</b>	1988	Zebary, Rekany, Narwami, Gully, Sendy, Mizury	<b>476</b>
<b>Girdachal</b>	1988	Halabja, Sendy, Showan, Zebary, Guly	<b>150</b>
<b>Qushtapa</b>	1978	Mizury, Barzany, Harky, Bradost	<b>8063</b>
<b>Daratoo</b>	1988	Qaladiza, Erbil area, Showan	<b>30000</b>
<b>Binaslawa</b>	1987	Luk, Showan, Nalia, Jabary, Mantik, Topzawa	<b>29939</b>
<b>Kasnazan</b>	1977	Baradosty	<b>12200</b>
<b>Total</b>			<b>177,818</b>

**Table A1:6 Collective Settlement Population Figures: Dohuk Governorate<sup>6</sup>**

<b>Settlement Name</b>	<b>Year of Construction</b>	<b>Predominant Tribe(s) Relocated in the Collective Settlement</b>	<b>Total Population of Settlement</b>
<b>Darkar Ajam</b>	1976	Barwary, Sendy	<b>5050</b>
<b>Hizawa</b>	1976	Barwary	<b>3954</b>
<b>Bersive</b>	1976	Barwary	<b>3919</b>
<b>Girik Sindi Sufla</b>	1976	Sendy	<b>1200</b>

<sup>6</sup> Source: Durham University Policy Planning Unit, Collective Settlement Survey, Summer 1998, in collaboration with Ministry of Reconstruction and Development (Erbil) and Directorate of Statistics (Suleimaniyah).



<b>Tilkabar</b>	1976	Sendy, Barwary	10000
<b>Cham Kurk</b>	1976	Musa Rashy, Kochar, Dosky	1600
<b>Derabon</b>	1976	Pizhdin	1360
<b>Feshkaboor</b>	1976	Musa Rashy, Sendy	1180
<b>Bakirman</b>	1976	Sendy, Gully, Shrenkhy	1050
<b>Khilekh</b>	1976	Sendy, Ziuky, Musyrash	850
<b>Qara wila</b>	1976	Pzhdin, Rezgary	275
<b>Batofa</b>	1976	Barwary, Gully	10583
<b>Qidish</b>	1978	Barwary, Gully	5700
<b>Begova</b>	1976	Nerway, Barwary, Dosky	4480
<b>Sheladzey</b>	1977	Dosky Zhory, Rekany	13700
<b>Deralook</b>	1977	Rekany, Nerwayi	9300
<b>Siry Be</b>	1977	Dosky Zhory, Rekany	8050
<b>Kany</b>	1977	Nerwa Rekan	5200
<b>Azadi</b>	1992	Dosky Zhory	800
<b>Mansooria (Miserky)</b>	1975	Kochar, Masihi, Sulaivany, Barwary	15400
<b>Batail</b>	1975	Sulaivany, Dosky, Barwary	1924
<b>Bastke</b>	1975	Sulaivany, Dosky	1604
<b>Girsheen</b>	1975	Sulaivany, Dosky, Miran, Barwary	1443
<b>Kharab dem</b>	1975	Sulaivany	1416
<b>Ismail Ava</b>	1975	Sulaivany	1266
<b>Kelik</b>	1975	Sulaivany	1240
<b>Bawarde</b>	1975	Sulaivany	1150
<b>Bajid Kandal</b>	1975	Hawery	522
<b>Khanky</b>	1987	Dinay, Hawry, Shingary, Arab, Sendy	13299
<b>Sharya</b>	1987	Dinany, Faidy, Hawry	7900
<b>Miqbla (camp)</b>	1976	Dosky Zhoru, Barwary Zhoru	1935
<b>Marona</b>	1975	Zedik, Mizuri, Dosky, Kochar, Barwary	1703
<b>Giery Gawre</b>	1988	Kochar, Sulaivany	1324
<b>Miqbla</b>	1975	Sulaivany, Mizuri	560
<b>Bagerat</b>	1976	Nerwa Rekan	6350
<b>Kuret Gavana</b>	1977	Balakaiaty	4400
<b>Ba'adry</b>	1975	Hawery, Simoqy	6550
<b>Kalakchin</b>	1975	Goran	17315

<b>Qasrok</b>	1976	Mizury, Kochar, Sulaivany	9200
<b>Chira</b>	1976	Goran, Govay, Zebary	8350
<b>Girbeesh</b>	1986	Zebary	301
<b>Azadi-1</b>	1987	Teary	750
<b>Total</b>			<b>194,153</b>

**Table A1:7 Collective Settlement Population Figures: Suleimaniyah Governorate<sup>7</sup>**

<b>Settlement Name</b>	<b>Year of Construction</b>	<b>Predominant Tribe(s) Relocated in the Collective Settlement</b>	<b>Total Population of Settlement</b>
<b>Haji Awa</b>	1988	Pishdary, Merga	35000
<b>Sharushyan</b>	1977	Ako, Sharoshy	11500
<b>Ranyah</b>	1979	Ako	5721
<b>Choman</b>	1983	Balak	2975
<b>Shkarta</b>	1987	Khoshnaw	6685
<b>Tuasoran</b>	1978	Ako	450
<b>Zharawa</b>	1978	Nuradeeny	416
<b>Bastasen</b>	1978	Mangur	200
<b>Pemalk</b>	1978	Nuradeeny	14300
<b>Piramagrun</b>	1988	Jaf, Qaraways	17118
<b>Baryka</b>	1987	Jaf	10500
<b>Arbat</b>	1977	Jaf	7164
<b>Bazyan Asri</b>	1987	Manmi, Hamawand	30715
<b>Baynjan</b>	1988	Kafroshi, Hamawand	12000
<b>Allahi</b>	1976	Mirawli, Shenaki	3650
<b>Taynal</b>	1976	Shynakayati	2351
<b>Gopala</b>	1976	Kafroshi, Hamawand	2156
<b>Bazian-1</b>	1989	Pishdary	504
<b>Bazian-2</b>	1989	Pishdary	13
<b>Raparin</b>	1976	Ismail Uzery	4970
<b>Tasluja</b>	1975	Ismail Uzery, Mirawli	4300
<b>Khurmali</b>	1978	Haruni, Hawrami	4600
<b>New Halabja</b>	1988	Rokhzadi, Mekayli, Galali, Hawrami	31200

<sup>7</sup> Source: Durham University Policy Planning Unit, Collective Settlement Survey, Summer 1998, in collaboration with Ministry of Reconstruction and Development (Erbil) and Directorate of Statistics (Suleimaniyah).



<b>Shanadari</b>	1978	Zangana, Jabari	<b>553</b>
<b>Seerwan</b>	1978	Hawrami, Garmiany, Nauroly, Shamerani	<b>1957</b>
<b>Zamaqi</b>	1978	Hawrami, Shamerani, Nauroly,	<b>1060</b>
<b>Anab</b>	1978	Hawrami, Shamerani, Hawari	<b>6590</b>
<b>Total</b>			<b>218648</b>

**Table A1:8 Collective Settlement Population Figures: Darbandikhan Governorate<sup>8</sup>**

<b>Settlement Name</b>	<b>Year of Construction</b>	<b>Predominant Tribe(s) Relocated in the Collective Settlement</b>	<b>Total Population of Settlement</b>
<b>Shorish (Sangaw, Qara Hanjeer)</b>	1987	Jaf, Zangana	<b>16000</b>
<b>Takya</b>	1975-1978	Showan, Pishder, Qalasewka	<b>15800</b>
<b>Piryari</b>	1987	Jaf, Zangana, Shekhan, Jabari	<b>12376</b>
<b>Qadir Karam</b>	1987	Zangana, Shekhan, Jabari, Qalasewka	<b>10561</b>
<b>Zarayan</b>	1978	Tauguzi, Hozibawa, Sherabayani	<b>10085</b>
<b>Nasir</b>	1985	Jaf	<b>5000</b>
<b>Smud</b>	1987	Jaf, Zangana, Dawda, Shekhan, Zand	<b>19946</b>
<b>Total</b>			<b>89,768</b>

<sup>8</sup> Source: Durham University Policy Planning Unit, Collective Settlement Survey, Summer 1998, in collaboration with Ministry of Reconstruction and Development (Erbil) and Directorate of Statistics (Suleimaniyah).

## Appendix 2: Key Agreements Between Parties

### The Text of the 11 March Agreement of 1970 Between the KDP and GOI<sup>1</sup>

1. The Kurdish language shall be, alongside the Arabic language, the official language in areas with a Kurdish majority; and will be the language of instruction in those areas and taught throughout Iraq as a second language.
2. Kurds will participate fully in government, including senior and sensitive posts in the cabinet and the army.
3. Kurdish education and culture will be enforced.
4. All officials in Kurdish majority areas shall be Kurds or at least Kurdish speaking.
5. Kurds shall be free to establish student, youth, womens' and teachers' organizations of their own.
6. Funds will be set aside for the development of Kurdistan.
7. Pensions and assistance will be provided for the families of martyrs and others stricken by poverty, unemployment or homelessness.
8. Kurds and Arabs will be restored to their former place of habitation.
9. The Agrarian reform will be implemented.
10. The Constitution will be amended to read 'the Iraqi people is made up of two nationalities, the Arab nationality and the Kurdish nationality.'
11. The broadcasting station and heavy weapons will be returned to the Government.
12. A Kurd shall be one of the vice-presidents.
13. The Governorates (Provincial) Law shall be amended in a manner conforming with the substance of this declaration.
14. Unification of areas with a Kurdish majority as a self-governing unit.
15. The Kurdish people shall share in the legislative power in a manner proportionate to its population in Iraq.

---

<sup>1</sup> Source: Short and McDermott, 1975, *The Kurds*, Appendix 1.



## The Washington Agreement of 1998 Between the KDP and PUK

September 17, 1998

### Reaffirmation of Previous Achievements

On behalf of the Kurdistan Democratic Party (KDP) and Patriotic Union of Kurdistan (PUK), we thank Secretary Albright and the US government for facilitating a series of amicable and productive meetings here in Washington over the past several days. We appreciate their efforts in helping to bring us back together and to assist us in creating a framework for future cooperation. The meetings have been a major step forward towards a full and lasting reconciliation, which will provide new hope to the Kurds, Turkomen, and Assyrians and Chaldeans of the Iraqi Kurdistan region of Iraq.

Both parties also welcome the continuing engagement of the governments of Turkey and the United Kingdom in the peace and reconciliation process. We wish to recognize the irreplaceable role our separate consultations in Ankara and London played in making these talks a success.

In Washington, we have discussed ways to improve the regional administration of the three northern provinces and to settle long-standing political differences within the context of the Ankara Accords of October 1996. We have reached several important areas of agreement on how to implement those accords.

We affirm the territorial integrity and unity of Iraq. The three northern provinces of Dohuk, Irbil and Sulemaniyah are part of the Iraqi state. Both the KDP and the PUK unequivocally accept the recognized international boundaries of Iraq. Both parties are committed to preventing violations of the borders by terrorists or others.

Both parties will endeavor to create a united, pluralistic, and democratic Iraq that would ensure the political and human rights of Kurdish people in Iraq and of all Iraqis on a political basis decided by all the Iraqi people. Both parties aspire that Iraq be reformed on a federative basis that would maintain the nation's unity and territorial integrity. We understand that the U.S. respects such aspirations for all the Iraqi people.

Both parties condemn internal fighting and pledge to refrain from resorting to violence to settle differences or seeking outside intervention against each other. We

will endeavour to bring to justice those who violate the peace, whatever their political affiliation *or* motivation.

Both parties also agree that Iraq must comply with all relevant UN Security Council resolutions, including the human rights provisions of Resolution 688.

To help ensure a peaceful environment for reconciliation, we will intensify our arrangements to respect the cease fire, facilitate the free movement of citizens and refrain from negative press statements.

### Transition Phase

We have agreed to enhance the Higher Coordination Committee (HCC) to ensure that the humanitarian requirements of the people of the Iraqi Kurdistan region are met and their human and political rights are fulfilled. The decisions of the HCC will be by the unanimous consent of its members.

The HCC will prepare for a full reconciliation between the parties, including normalizing the situation in Irbil, Sulemaniyah and Dohuk; re-establishing a unified administration and assembly based on the results of the 1992 elections; providing exclusive control of all revenues to the regional administration; and organizing new regional elections.

The HCC will enhance coordination and cooperation among local public service ministries that serve the needs of the people throughout the Iraqi Kurdistan region. The parties will ensure that these ministries receive adequate revenue for their operation. The KDP acknowledges that, revenue differences will require a steady flow of funds for humanitarian services from the current KDP area to the current PUK area.

The HCC will establish a process to help repatriate everyone who had to leave their homes in the three northern provinces as a result of the prior conflict between the parties, and to restore their property or compensate them for their losses.

The HCC will ensure that both parties cooperate to prevent violations of the Turkish and Iranian borders. It will establish reasonable screening procedures to control the flow of people across these borders and prohibit the movement of terrorists. Both parties, working with the HCC, will deny sanctuary to the Kurdistan Workers Party



(PKK) throughout the Iraqi Kurdistan region . They will ensure that there are no PKK bases within this area. They will prevent the PKK from destabilizing and undermining the peace or from violating the Turkish border.

The HCC will endeavor to form an interim joint regional government within the next three months to be ratified by the regional assembly.

### Unified Administration

Within three months of its re-formation, the Assembly will meet at its building in Irbil, with subsequent meetings there or in Sulemaniyah or Dohuk. The members of the this interim assembly will be those individuals who were elected to the parliament in 1992.

The first meeting of the interim assembly will be within three months. After the assembly is established, it must authorize all subsequent decisions of the HCC and/or the interim regional government.

The interim assembly may decide to add additional functions to the operations of the HCC, including unifying relations with the international community.

To provide a safeguard for regional elections and to help normalize the status of Irbil, Dohuk and Sulemaniyah, the HCC and the assembly may establish a joint PUK-KDP-Turkomen-Assyrian security force. The new regional government may subsequently choose to take further measures to unify peshmerga (militia) command structures.

After the regional elections described below, the interim assembly will be replaced by a new regional assembly. This regional assembly will form a new regional government based on the voting strength of each party in the assembly.

When the regional government has been formed, the HCC will be dissolved automatically. The term of the regional assembly, the regional government will be three years.

### Revenue Sharing

Until the new interim joint regional government is established, a steady flow of funds for public service ministries will be directed from the current KDP area into the

current PUK area, due to revenue differences. The HCC, in consultation with the existing ministries of taxation and finance, is responsible for the apportionment of revenues throughout the region.

When the interim joint government is established, it will become responsible for the collection and distribution of all revenues.

After the election of a new regional assembly, a single Ministry of Revenue and Taxation will have exclusive responsibility for collecting all revenues, including taxes and customs duties. The funds collected will be at the disposal of the regional government for uses authorized by the regional assembly.

#### Status of Irbil, Dohuk and Sulemaniyah

The interim assembly and the HCC will address the normalization of Irbil, Dohuk, Sulemaniyah and other cities. The HCC may call on international mediation regarding this issue, if it deems it expedient.

The status of these cities must be normalized to a sufficient degree that free and fair elections can be held.

#### Elections

The interim assembly and the HCC will be responsible for organizing free and fair elections for a new regional assembly, to take place no later than six months after the formation of the interim assembly.

The composition of the new regional assembly will be based on the best available statistical data on the population of the three northern governorates and the distribution of ethnic and religious groups there. Seats will be set aside for the Kurdish, Turkomen, and Assyrian and Chaldean communities.

If possible, the interim assembly and the HCC, working with the international community, will conduct a census of the area in order to establish an electoral register. If international assistance is not available in time, the interim assembly and the HCC will conduct a census on their own, or--making reference to existing data -- they will construct a best estimate of the population in consultation with outside experts.



The interim assembly and the HCC will also invite international election monitors to assist both in the election itself and in training local monitors.

### Situation in the Iraqi Kurdistan Region

UN Security Council Resolution 688 noted the severe repression of the Iraqi people, particularly the Kurdish people in Iraq. The potential for repression has not eased since 1991, when the resolution was passed. It is worth noting that in the past year the UN Special Rapporteur for Iraq reported finding strong evidence of hundreds of summary executions in Iraqi prisons and a continuation by the regime of the policy of expelling Kurds and Turkomen from Kirkuk and other cities. This policy amounts to ethnic cleansing of Iraqi Kurds and Turkomen, with their lands and property appropriated by the government for disbursement to ethnic Arabs. Many of the new arrivals participate in this scheme only because of government intimidation.

In light of this continued threat, we owe a debt of thanks to the international community for assisting with our humanitarian needs and in preventing a repeat of the tragic events of 1991 and the horrific Anfal campaigns of 1987 and 1988:

The United Nations special program of "oil-for-food" for the Iraqi Kurdistan region has eased the humanitarian condition of the people. We welcome the support of the international community for the continuation of this program, with its specific allotment to the Iraqi Kurdistan region, and hope that, in the near future, a liaison office for the region can be established at ECOSOC headquarters to better coordinate the provision of the aid. We also hope that, in the event that benefits from the "oil-for-food" program are suspended due to unilateral action by the government of Iraq, the UN will address the continuing economic needs of Iraqi Kurdistan and the plight of the people there.

The United States, the Republic of Turkey and the United Kingdom through Operation Northern Watch have helped to protect the area. We call upon them and the rest of the international community to continue to exercise vigilance to protect and secure the Iraqi Kurdish region.

The many non-governmental organizations that operate in the three northern provinces have diminished our isolation and helped us in countless ways.

## Future Leader-to-Leader Meetings

The President of the KDP and the Secretary General of the PUK will meet at least every two months inside or outside Iraqi Kurdistan at mutually acceptable sites.

Pending the agreement of governments, we hope to hold the first such meeting in Ankara and a subsequent meeting in London.

The Ankara meeting would include discussions on our joint resolve to eliminate terrorism by establishing stronger safeguards for Iraq's borders. The London meeting may explore further details concerning the status of Irbil, Dohuk and Sulemaniyah, and help establish a mechanism for the conduct of free and fair elections.

Jalal Talabani

Patriotic Union of Kurdistan.

Massoud Barzani

Kurdistan Democratic Party.

Witness: C. David Welsh

Principal Deputy Assistant Secretary

Near East Affairs Bureau

Department of State, Washington D.C.

Washington D.C.

September 17, 1998

Timetable:

On or before:

October 1:

The KDP begins to extend appropriate financial assistance on monthly basis to the public service ministries in the PUK areas.

October 15:

Timeline for repatriation of persons displaced by the former conflict. Agreement on restoration of property or compensation by responsible parties.

Beginning



November:

Joint consultations with the Government of Turkey .

November 1:

Coordination and Cooperation of humanitarian ministries complete.

Revenues contributed by KDP to the ministries flowing from KDP areas to PUK areas.

November 15:

Progress report on repatriation, unification of ministries and revenue sharing.

January 1:

First meeting of the interim assembly.

March 1:

Interim Joint Government establishes a plan to normalize Irbil, Dohuk and Sulemaniyah.

April 1:

Interim Joint Government establishes a plan for the organization of elections.

July 1: Regional elections.

### Appendix 3: Party Lists

**Table A3:1 The Central Committee of the KDP (Eleventh Congress)<sup>1</sup>**

Name	Additional Office	Government Office
Massoud Barzani	President	
Ali Abdullah	Deputy President	
Sami Abdul Rahman	Head of Political Bureau	
Nechervan Barzani	Political Bureau steering committee	Deputy Prime Minister
Arif Taifour	Political Bureau steering committee	
Shawkat Sheikh Yazdeen	Political Bureau	Minister of Finance
Azzaddin Barwari	Political Bureau, Dohuk Branch (1)	
Fadhil Merani (Mutni)	Political Bureau	Minister of Interior
Falakadin Kakai	Political Bureau	Minister of Culture
Hoshyar Zebari	Political Bureau	
Jawher Namiq Salim	Political Bureau	Speaker of KNA
Roj Nuri Shawaise	Political Bureau	Prime Minister
Jerjees Hassan	Political Bureau	Minister of Education
Za'een (Rafiq) Ali	Political Bureau	Minister of <i>Peshmerga</i>
Bruska Nuri Shawaise	Adviser to Barzani	
Sa'ad Abdullah	Head of Erbil Branch (2)	
Omar Botani	Damascus representative	
Salah Delo	Head of Kirkuk Branch (3)	
Massoud Salayi	Central Office of Organization	
Abu Shareen	Head of Baghdad Branch (5)	
Ali Sinjari		
Mohammad Kadir		
Nidhmadin Gilli		
Omer Othman	Head of Soran Branch (10)	
Sayed Kaka		
Akram Mantiq	Head of Qala Diza Branch (11)	
Kamal Chawshin	Head of Suleimaniyah Branch (4)	
Darwesh Abdulla		
Qadr Qadr	Head of Aqra Branch (9)	
Ramzi Sheban	Central Office of Finance	
Abdulla Agreen		
Karim Sinjari	Deputy Head of KDP Intelligence	
Franso Hariri		Governor of Erbil, MP
Jalal Faili		
Mohammad Mahmoud		
Kamal Kirkuki	Head of USA & Canada Branch (7)	
Kadir Jabari		Minister of Justice
D.N. Ghafour		
Barzan Khalid		
Nuri Hama Ali	Head of Halabja Branch (12)	

<sup>1</sup> Interview with Sa'ad Abdullah, Erbil, 9 September 1999.



**Table A3:2 The Central Committee of the KDP (Twelfth Congress)<sup>2</sup>**

<b>Name</b>	<b>Additional Office</b>	<b>Government Office</b>
Massoud Barzani	President	
Ali Abdullah	Deputy-President	
Nechervan Barzani	Political Bureau	Prime Minister
Masrouf Massoud Barzani	Political Bureau	
Shawkat Sheikh Yazdeen	Political Bureau	Cabinet Minister
Fadhil Merani	Political Bureau	Minister of Interior
Roj Nuri Shawaise	Political Bureau	Speaker of KNA
Hoshyar Zebari	Political Bureau	
Sami Abdul Rahman	Political Bureau	Deputy Prime Minister
Jawher Namiq Salim	Head of Political Bureau	
Azad Berwari	Political Bureau	
Karim Sinjari	Deputy-Head KDP Intelligence	
Nuri Hama Ali		
Arif Taifour		
Za'em Ali		Minister of <i>Peshmerga</i>
Saleh Delo		
Ramzi Shaban		
Omer Botani		
Sharam Anmedi		
Jamal Mortaq		
Kamal Kirkuki		
Sarbaz Hawrami		
Franso Hariri	Head of Erbil Branch (2)	
Omer Othman		
Bruska Nuri Shawaise	Adviser to Barzani	
Safeen Muhsin Dizayee		
Qadr Qadr		
Izaddin Berwari		
Sa'ad Abdullah		Minister of Agriculture
Mahmoud Malaqadr		
Jerjees Hassan		

<sup>2</sup> Interview with Sa'ad Abdullah, Erbil, 9 September 1999.

**Table A3:3 The Leadership Office of the PUK - 1999**

<b>Name</b>	<b>Additional Office</b>	<b>Government Office</b>
Jalal Talabani	Secretary General	
Qosrat Rasul	Political Bureau steering committee	Prime Minister
Fu'ad Massoum	Political Bureau, Overseas Branch	
Kamal Fu'ad	Political Bureau steering committee	
Barham Salih	US representative	
Mulazim Omer	Political Bureau	Minister of Finance
Omer Sa'id Ali	Political Bureau, Suleimaniyah Branch	
Ihmad Ahmed	Political Bureau	Minister of Power
Arsalan Baez	Political Bureau	
Omer Fattah	Political Bureau steering committee, Deputy Head of <i>Zenyari</i>	
Jabar Farman	Political Bureau steering committee, Deputy Head of <i>Peshmerga</i>	
Feyeradun Abdul Khadir	Political Bureau	
Khadir Haji Ali	Political Bureau	
Mohammad Tawfiq	Political Bureau	
Dara Sheikh Nuri	Political Bureau	
Omer Abdullah	Political Bureau steering committee	
Abu Bakr Khoshnaw		
Shawkat Haji Mushir	Head of Sharazur Branch (9)	
Mustafa Sa'id Khadir		
Mustafa Chaw Rash	Head of Raniyah Branch (6)	
Kurdo Qasim		
Bahraz Galali		
Mulla Bakhtier	Deputy Head of Democratic Organizations	
Salar Aziz		
Mohammad Shakeri	Head of Kirkuk Branch (2)	
Sa'adi Ahmed Pira	Deputy Head of Foreign Relations	
Adil Murad	Deputy Head of Media Office	
Adnan Mufti		Minister of Finance
Chato Howezi		
Shertle Howezi		
Arif Rushdi		
Sa'adun Faheli		
Shakawahn Abbas	Head of Erbil Branch (3)	
Azad Jundiani	Head of Soran Branch (5)	
Adnan Hama Mina	Head of Garmian Branch (8)	
Baroj Galali		
Hazim Yousifi		
Othman Haji Mahmoud		
Jalal Jawher		Minister of Municipalities
Abdelkarim Haji		



## Appendix 4: Election Results and KNA Representatives

**Table A4:1 The Results of the 1992 Elections –  
KDP Figures from High Committee Lists<sup>1</sup>**

Province	Number of votes							
	KDP	PASOK	KPDP	ICP	IMK	Inds.	PUK	Invalid
Dohuk	168,683	1,983	6,051	1,546	3,874	49	15,184	982
Erbil	152,143	8,883	2,101	11,047	11,092	184	148,352	2,025
Suleimaniyah	92,449	11,978	1,118	5,693	29,334	213	207,168	1,211
Darbandikhan	24,604	2,038	663	2,837	4,808	55	53,129	506
<b>Total</b>	<b>437,879</b>	<b>24,882</b>	<b>9,903</b>	<b>21,123</b>	<b>49,108</b>	<b>501</b>	<b>423,833</b>	<b>4,724</b>
<b>Percentage</b>	<b>45.05</b>	<b>2.56</b>	<b>1.02</b>	<b>2.17</b>	<b>5.05</b>	<b>0.05</b>	<b>43.61</b>	<b>0.49</b>
<b>Total no. of votes</b>								<b>971,953</b>
<b>Total no. of valid votes</b>								<b>967,229</b>

**Table A4:2 Christian Minority Lists**

Province	Number of votes					
	ADM.	DC	KAD	KCU	Invalid	Total
Dohuk	5,555	181	241	1,841	59	7,877
Erbil	900	347	1,855	880	29	4,011
Suleimaniyah	83	9	38	36	0	166
Darbandikhan	5	0	0	0	0	5
<b>Total</b>	<b>6,543</b>	<b>537</b>	<b>2,134</b>	<b>2,757</b>	<b>88</b>	<b>12,059</b>
<b>Percentage</b>	<b>54.26</b>	<b>4.45</b>	<b>17.70</b>	<b>22.86</b>	<b>0.73</b>	<b>100</b>
<b>Total no. of valid votes</b>						<b>11,971</b>

<sup>1</sup> Hoff, *et. al.*, 1992, p. 13, quoting High Committee lists.

**Table A4:3 Proportional Redistribution of Votes to KDP and PUK Lists (KDP)**

Party	Number of votes					
	1 <sup>st</sup> Count	%	Redistributed	%	Total	%
KDP	437,879	45.05	53,689	50.88	491,477	50.8
PUK	423,833	43.61	51,899	49.18	475,732	49.2
Total	861,712	88.66	105,518	100.06	967,229	100

**Table A4:4 Figures Forwarded by the PUK**

Party	List No.	Number of votes	
		Valid votes	%
KDP	1	428,339	44.52
PUK	7	423,682	44.03
IMK	5	49,073	3.10
PASOK	2	24,867	2.58
ICP	4	21,106	2.19
KPDP	3	9,902	1.03
Inds.	6	500	---
<b>No. of invalid votes</b>		<b>4702</b>	
<b>Total no. of valid votes</b>		<b>957,469</b>	

**Table A4:5 Proportional Redistribution of Votes to KDP and PUK Lists (PUK)**

Party	Number of votes					
	1 <sup>st</sup> Count	%	Redistributed	%	Total	%
KDP	428,339	44.52	53,012	50.27	481,351	50.27
PUK	423,682	44.03	52,435	49.73	476,118	49.73
Total	852,021	88.55	105,448	100	957,469	100



**Table A4:6 The Members of the Kurdistan National Assembly, 1992*****Kurdistan Democratic Party Block***

1. Abraham Saeed Muhammad
2. Idris Hadi Saleh
3. Azad Fatah Rashid Meeran
4. Ahmed Salar Abdul-Wahid
5. Ahmed Ali Omer
6. Akbir Haeeda Musa
7. Akram Eazat Najeeb
8. Barzan Khalid Aziz
9. Jaefar Sheikh Ali Abdul-Aziz
10. Aameel Abdi Sindi
11. Aawhar Ahmed Shawaz Galali
12. **Jawher Namiq Salim**
13. Hassan Hussein Bafri
14. Hama Najim Hama Faraj Jaf
15. Hamid Salim Meeran
16. Khaeri Ali Bag Yazid
17. **Dr. Roj Nuri Shawaise**
18. Sa'eed Muhammad Sa'eed Hirari
19. Safar Muhammad Hussein Doski
20. Salim Ali Huji Malo
21. Shfeeka Fake Abdul Allah
22. Sherwan Nasifi Al-Haydari
23. Mala Talal Saeed Korani
24. Salahadin Abraham Dalo
25. Adnan Hussamaddin Al-Naqishbandi
26. Afaf Othman Al-Naqishbandi
27. Fadhil Rauf Jakzi
28. Farham Abdul-Allah Agha Al-Sharfani
29. Firsan Ahmed Abdul-Allah
30. **Franso Toma Kanon Al-Hariri**
31. **Fallakaddin Sabir Kakai**
32. Fawziya Azaddin Rashid
33. Kasim Muhammad Kasim

***Patriotic Union of Kurdistan Block***

- Abu Bakir Haji Safar Ghulam  
 Ahmed Abu-Bakir Hassan Barmarni  
 Ahmed Tahir Ahmed Al-Naqishbandi  
**Arsalan Bayez Ismail**  
 Ayad Haji Namiq Majid Bakal  
 Parakhan Mahmoud Abdul-Kadir  
**Jalal Jawher Aziz**  
**Jalal Shafiq Ali**  
 Hassan Hameed Rahim (Rustam)  
 Hassan Kanobi Khithir Bilbas  
 Hassan Abdul Karim Barzinji  
 Hussein Arif Abdul-Rahman  
**Khasro Gul Muhammad**  
 Hassan Ahmed Abdul Kuwestani  
**Sa'adi Ahmed Muhammad Pira**  
 Sa'adi Ali Khan Abdel Sleevani  
 Salam Karim Khan Muhammad Khalifa  
 Sirwan Muhammad Nuro  
**Shawkat Haji Mushir Muhammad**  
 Sheeko Fayk Abdul-Allah Bekas  
 Salahadin Abdul-Hamid Abdul-Allah  
 Salahadin Muhammad Hassan Hafid  
 Taha Muhammad Taha Mula  
 Tariq Muhammad Saeed Jambaz  
**Abdullah Rasoul Ali (Qosrat)**  
 Abdullah Haji Abraham Abdullah  
 Abdul-Khalid Muhammad Rashid Zangana  
 Abdul Karim Kaka Hama Abdul Karim  
 Ezaddin Mustafa Rasoul  
**Ali Abdullah Ahmed**  
 Ali Rasoul Rustam  
**Omer Sayid Ali Hussein**  
**Omer Abdulallah Muhammad**

- |  |                                      |
|--|--------------------------------------|
| 34. Qais Dywali Saeed Al-Doski           | Kadir Aziz Hama Amin                 |
| 35. Kanabi Aziz Ahmed Dizayee            | Kadir Mamand Babakir Agha            |
| 36. <b>Mamun Mir.Mohammad Brifkani</b>   | Kamal Abraham Faraj Shali            |
| 37. Sheikh Muhsin Khalid Mufti           | Kamal Jalal Ghareeb                  |
| 38. Muhsin Salah Al-Katani               | <b>Kamal Abdul Karim Fuad</b>        |
| 39. Muhammad Mawlud Amin Mawlud          | Galawez Abdul Jabar Mafeed Jabari    |
| 40. Mala Muhammad Tahir Zaeen Al-Adeen   | Muhammad Amin Abdul-Hakim            |
| 41. Muhammad Saeed Ahmed Al-y-kubi       | <b>Muhammad Tawfiq Hama Rahim</b>    |
| 42. Mala Muhammad Shareef Tahir Al-Doski | Muhammad Fadhil Aziz Kaftan          |
| 43. Muhammad Abdul-Kadir Ahmed           | <b>Muhammad Fuad Massoum Khadir</b>  |
| 44. Mala Mohammad Fandi Deershawe        | Mustafa Kadir Mustafa                |
| 45. Mamand Muhammad Amin Babakir         | Mathir Ali Mustafa Kakayee           |
| 46. Nihad Nuraddin Rashid                | Noshirwan Fuad Maruf Masti           |
| 47. Mala Hadi Khithee Chokha             | <b>Najmaddin Aziz Ismail (Salar)</b> |
| 48. Wrya Ahmed Muhammad Amin             | Nazad Ahmed Aziz Agha                |
| 49. Yahya Mohammad Al-Barzinji           | Nahla Muhammad Saad-Al-Allah         |
| 50. Younis Mohammad Salim Rozbiyani      | <b>Hero Abraham Ahmed</b>            |

***The Assyrian Democratic Movement Block***

1. **Younidan Yousif Kana**
2. Shamil Binyamin
3. Francis Yousif Shaba
4. Akram Ashur Odish

***The United Christian List***

1. Sarkis Agha-Jan Ma Mindo



## Appendix 5: Ministry Organograms

Figure A5:1: Ministry of Municipalities and Tourism

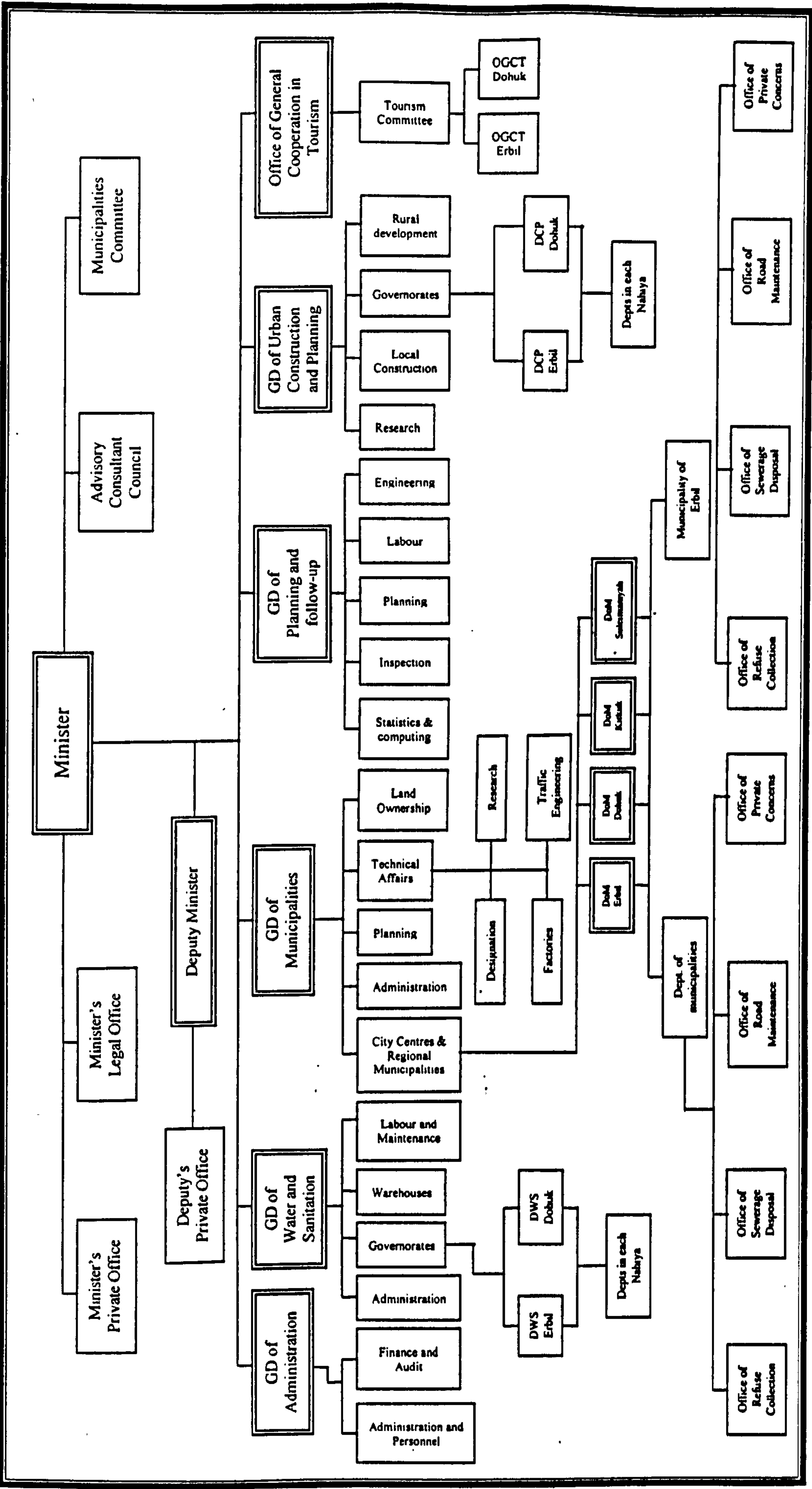



Figure A5:2: Ministry of Agriculture and Irrigation

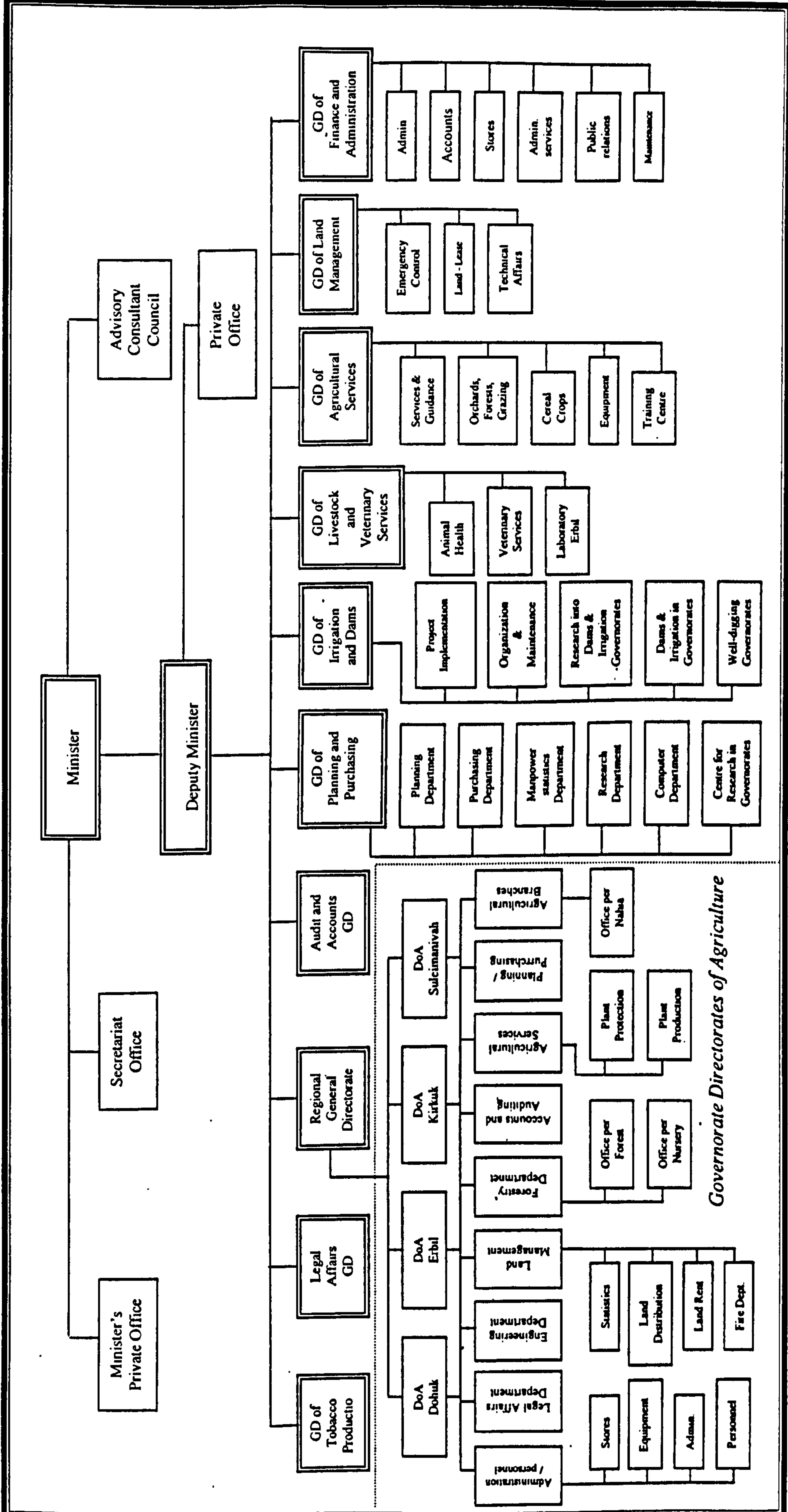

Figure A5:3: Ministry of Religious Endowment & Islamic Affairs

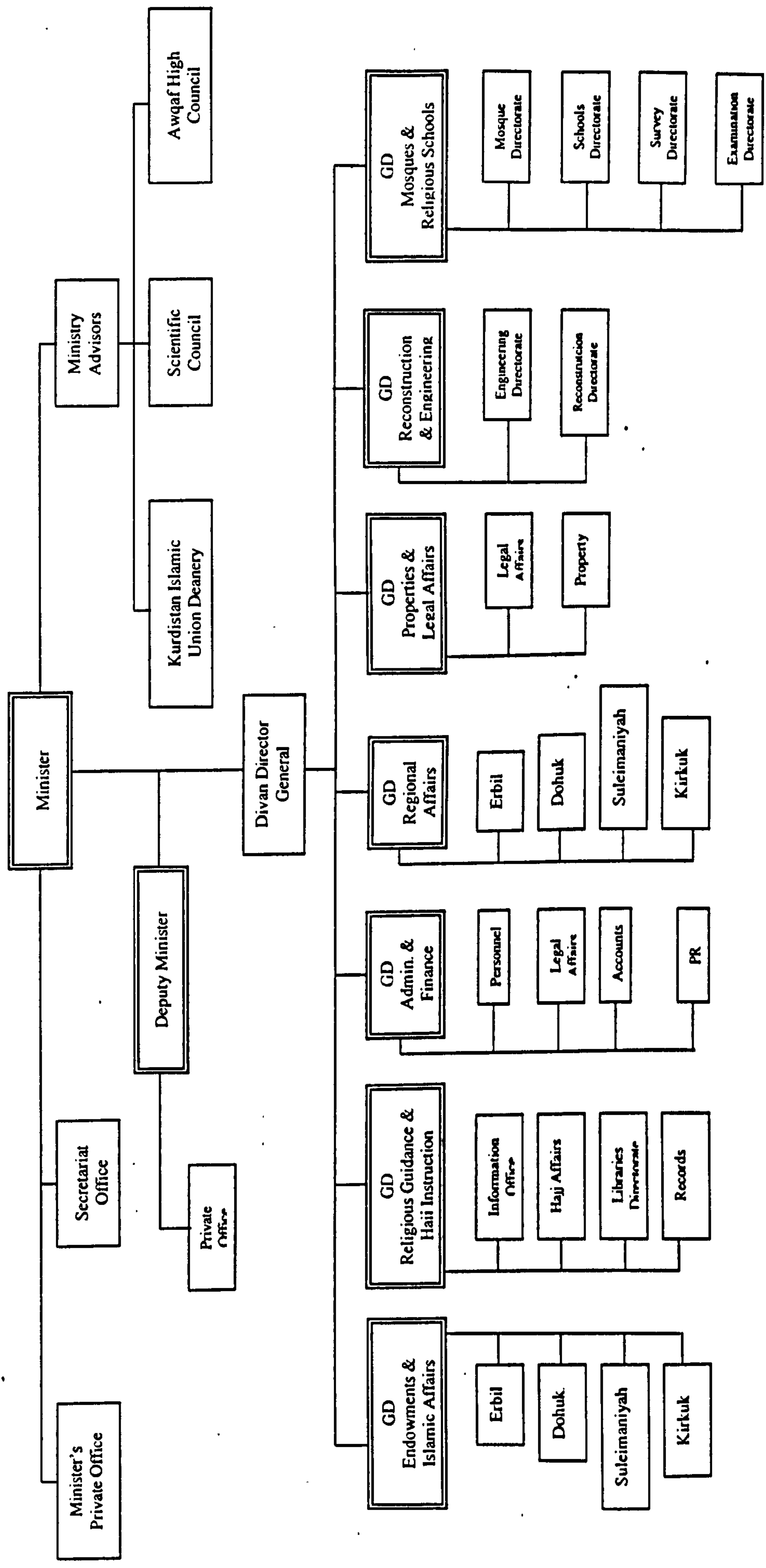



Figure A5:4: Ministry of Culture

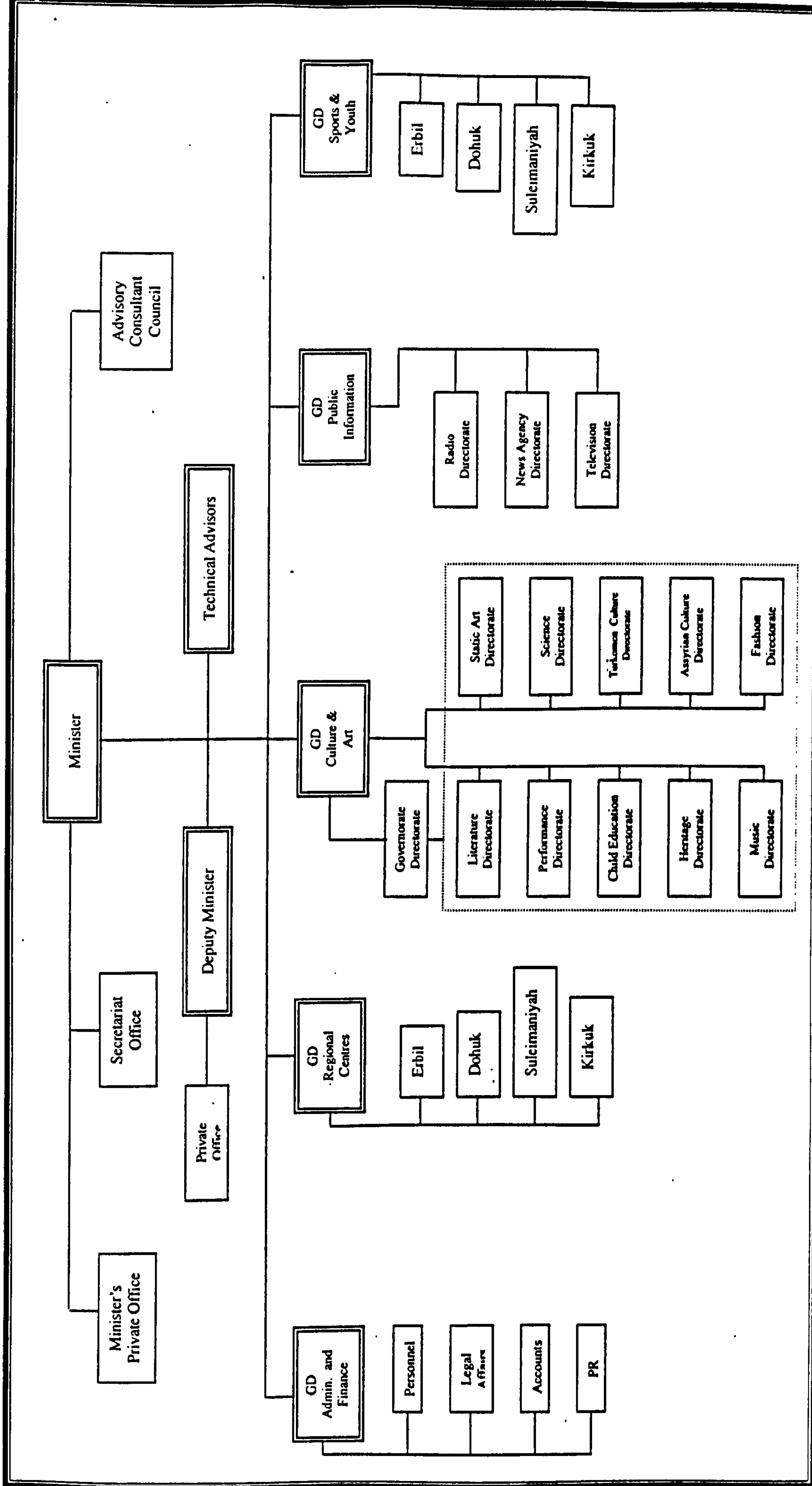

Figure A5:5: Ministry of Education

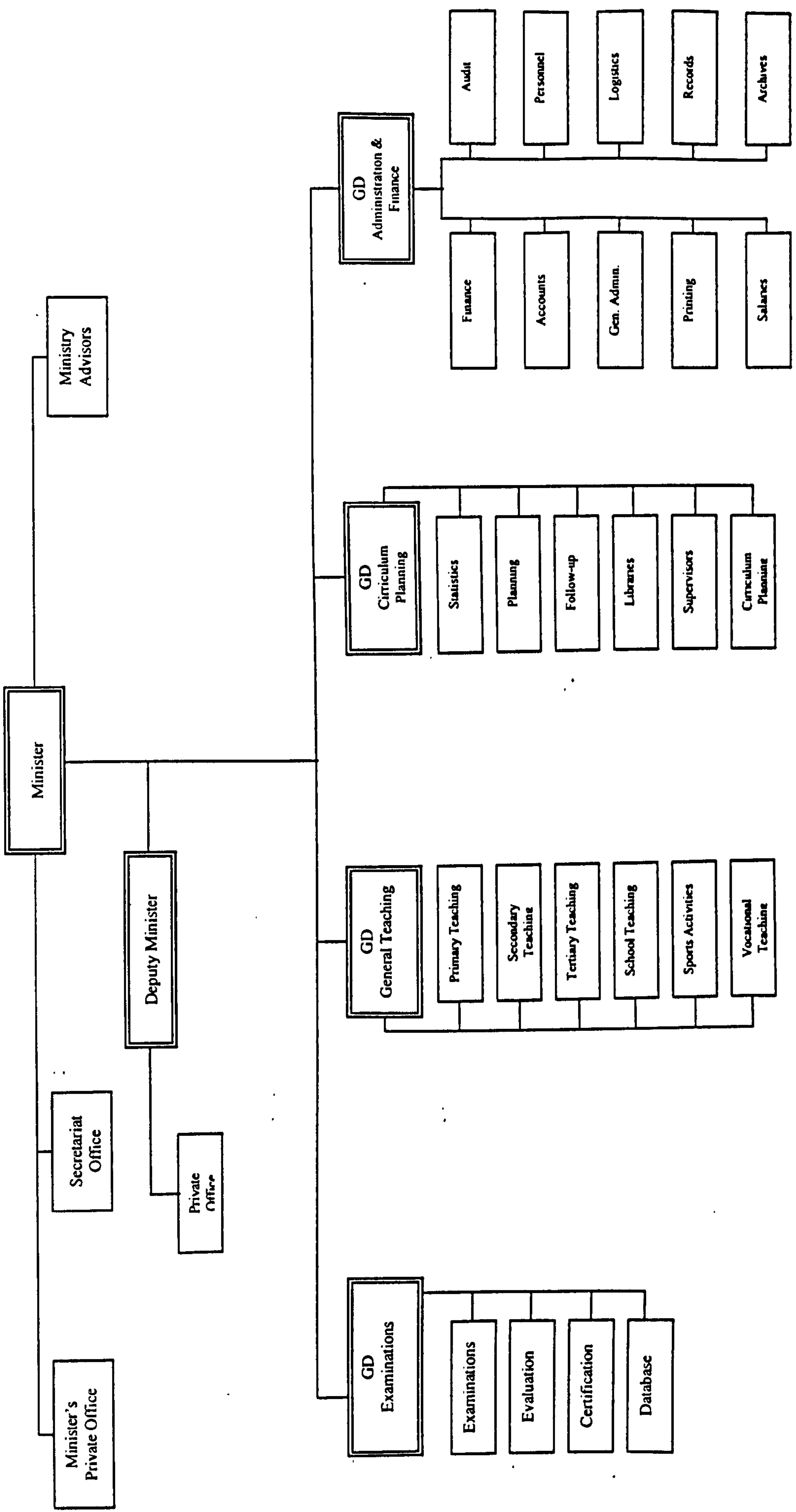
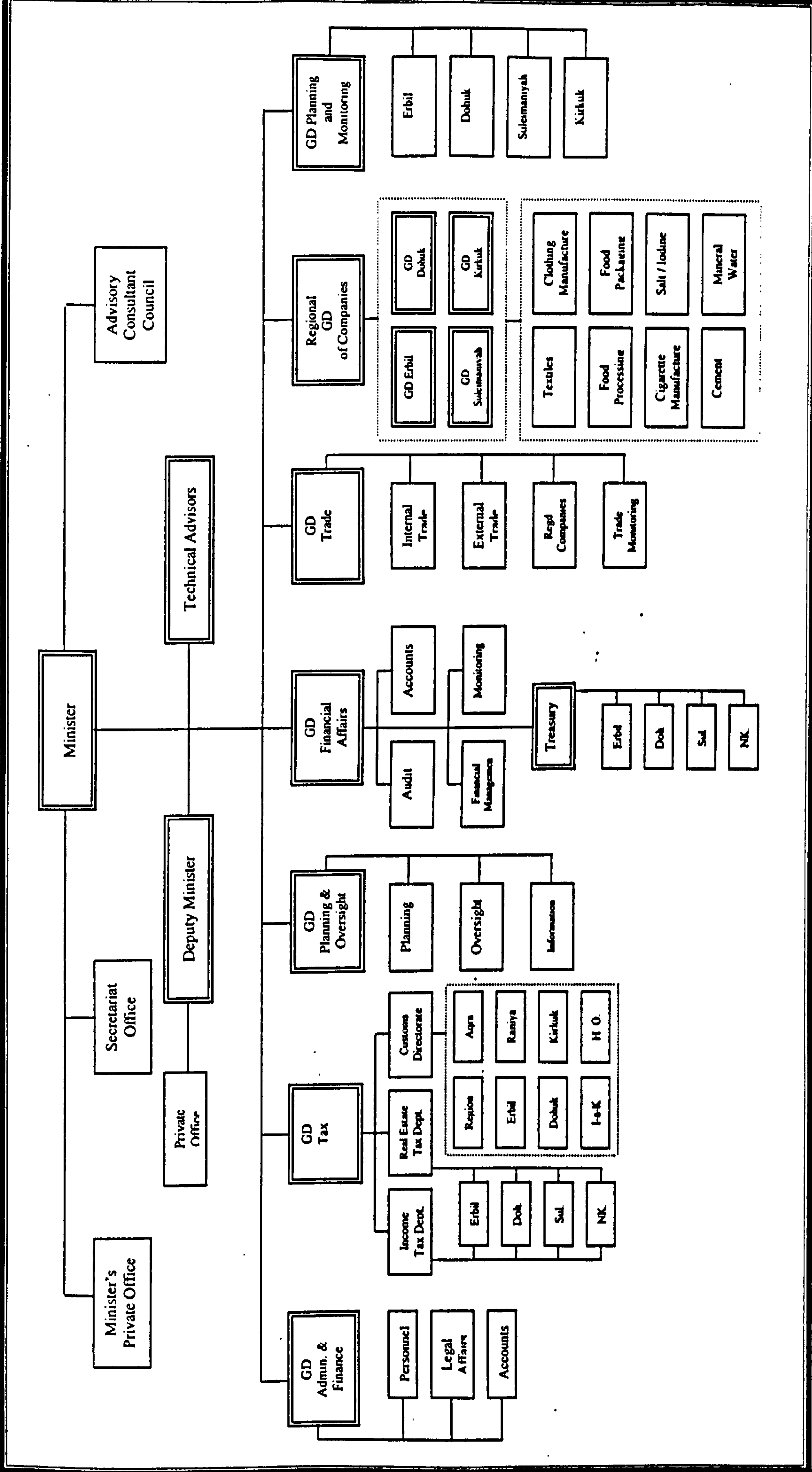



Figure A5:6: Ministry of Finance & Economic Affairs



**Figure A5:7: Ministry of Humanitarian Aid & Cooperation**

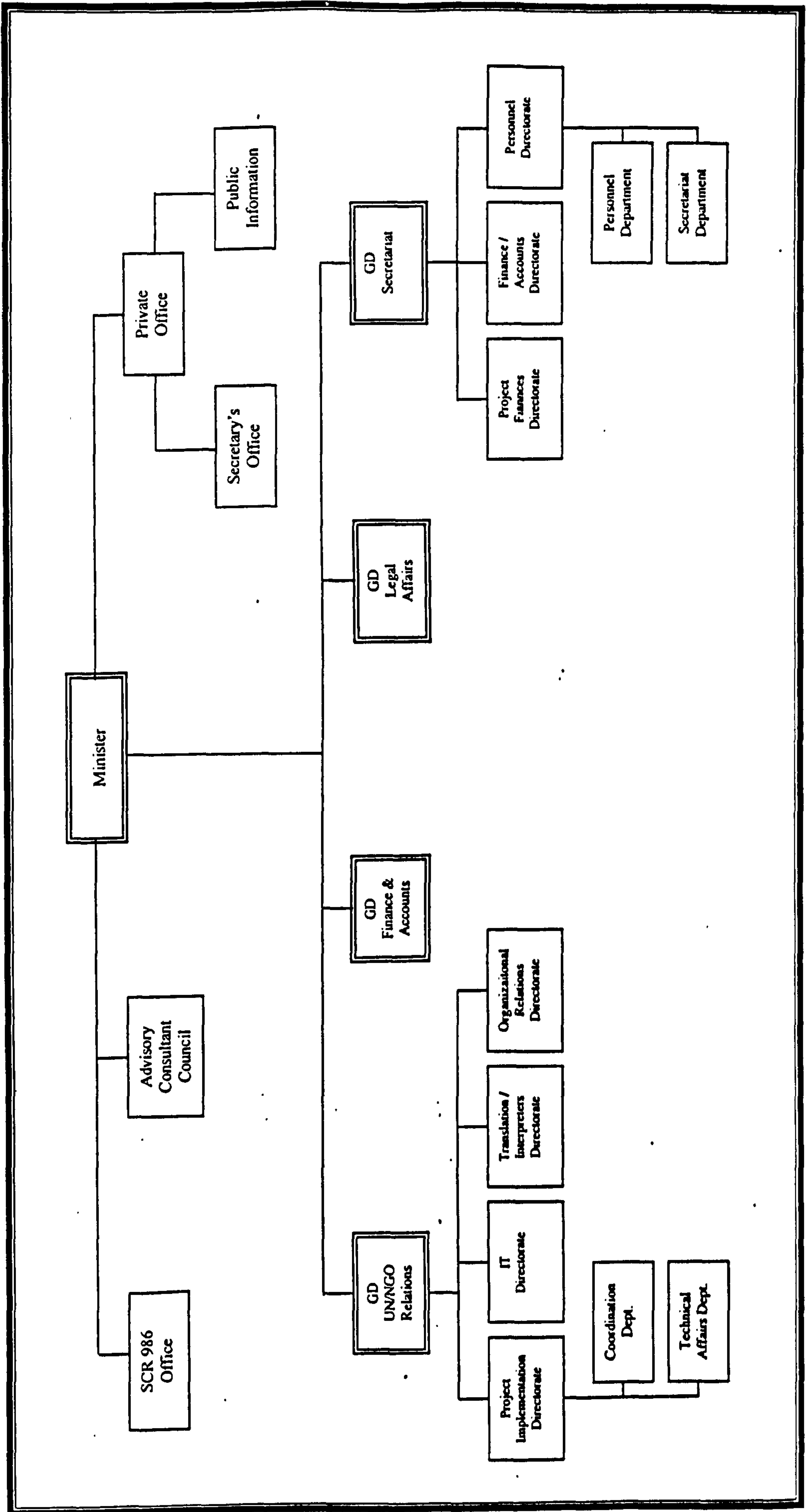



Figure A5:8: Ministry of the Interior

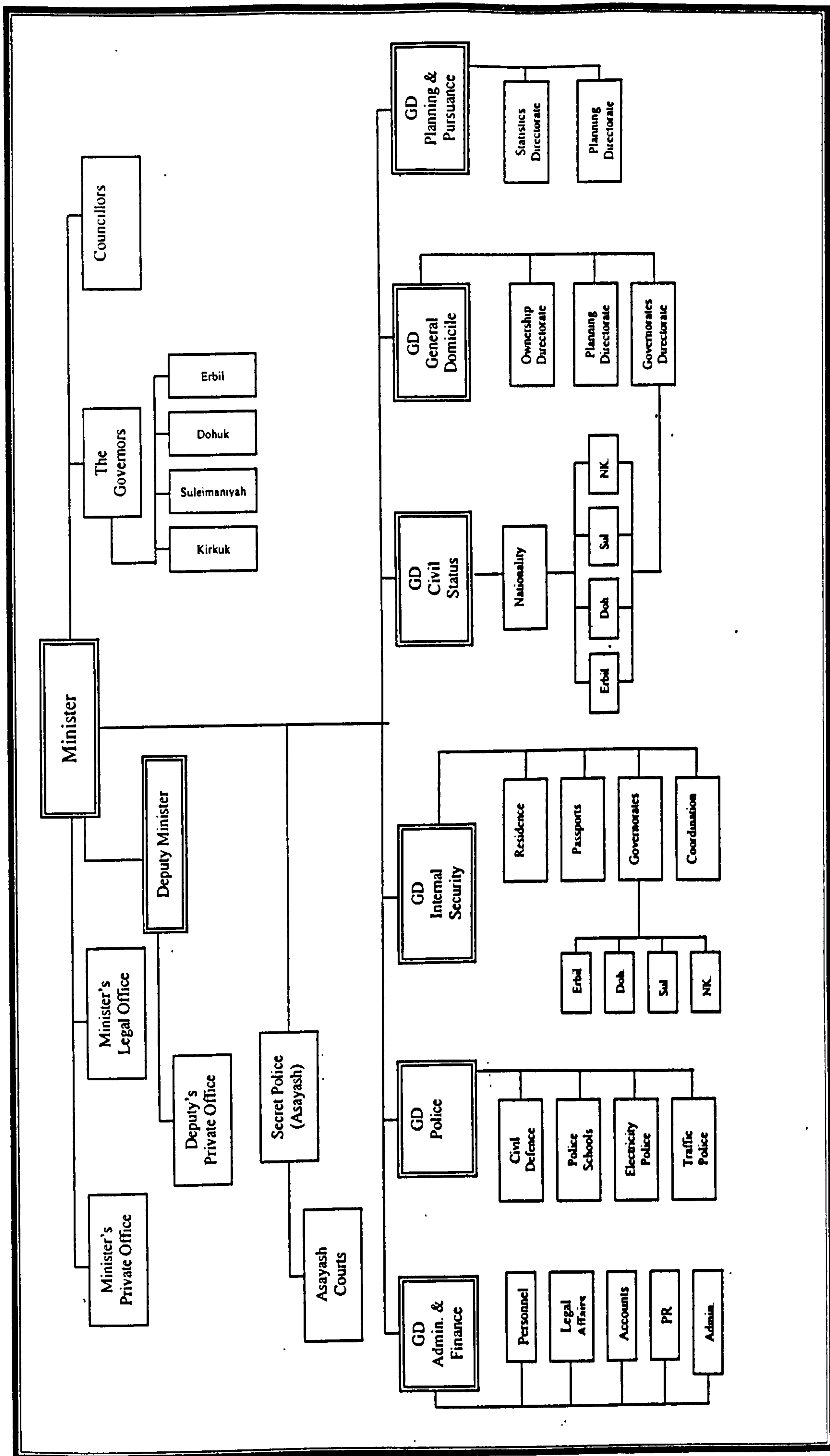

Figure A5:9: Ministry of Justice

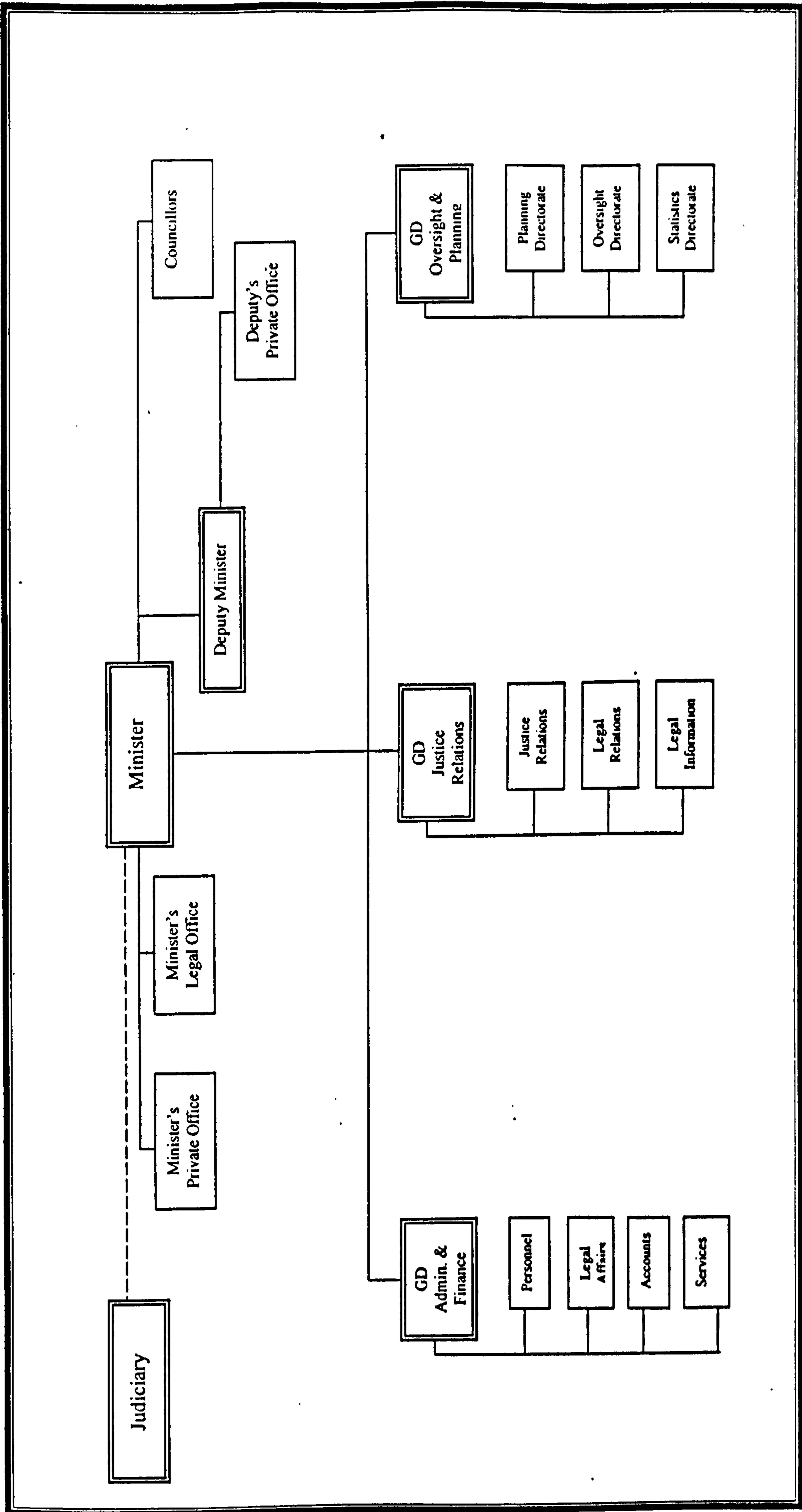



Figure A5:10: Ministry of Peshmerga Affairs

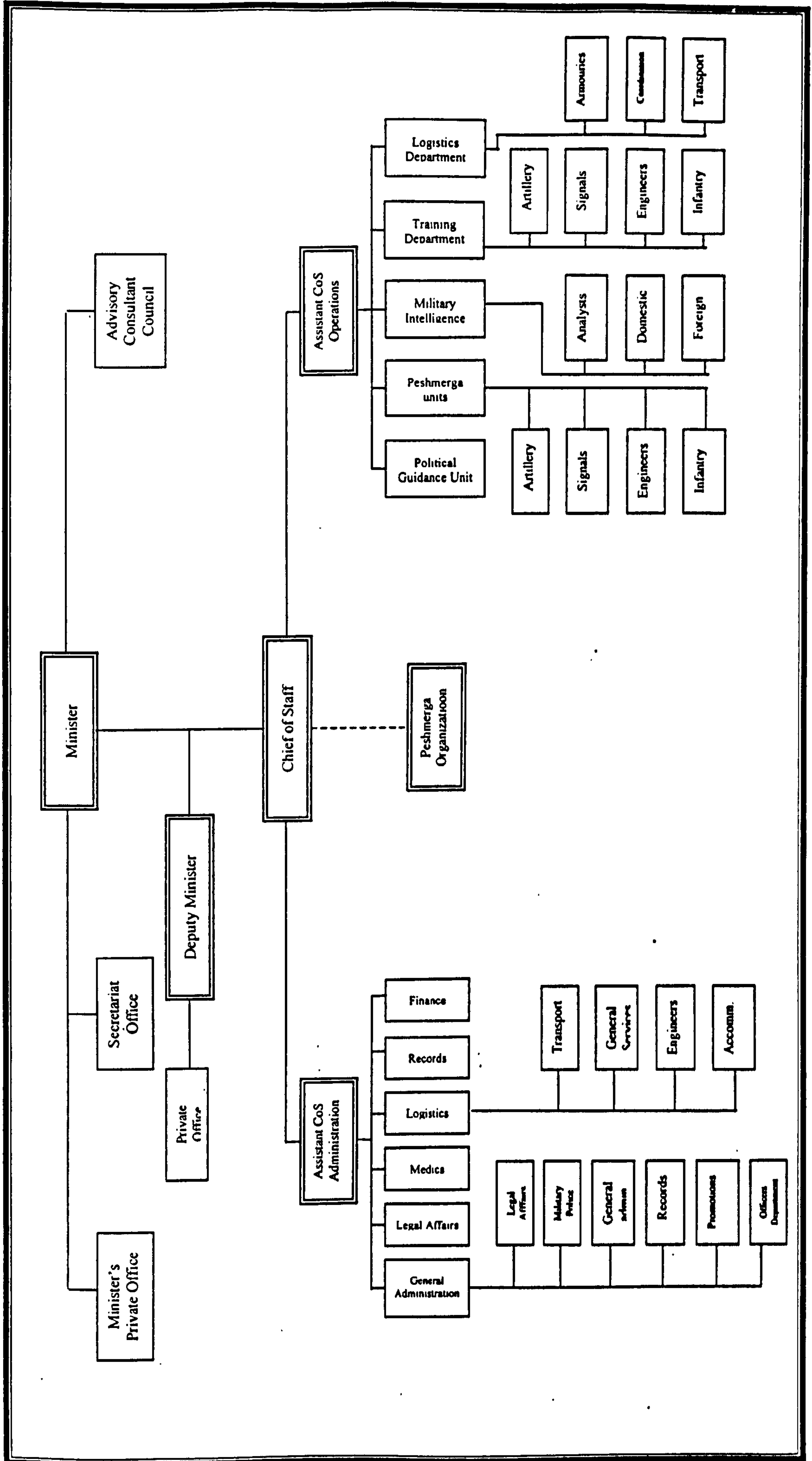
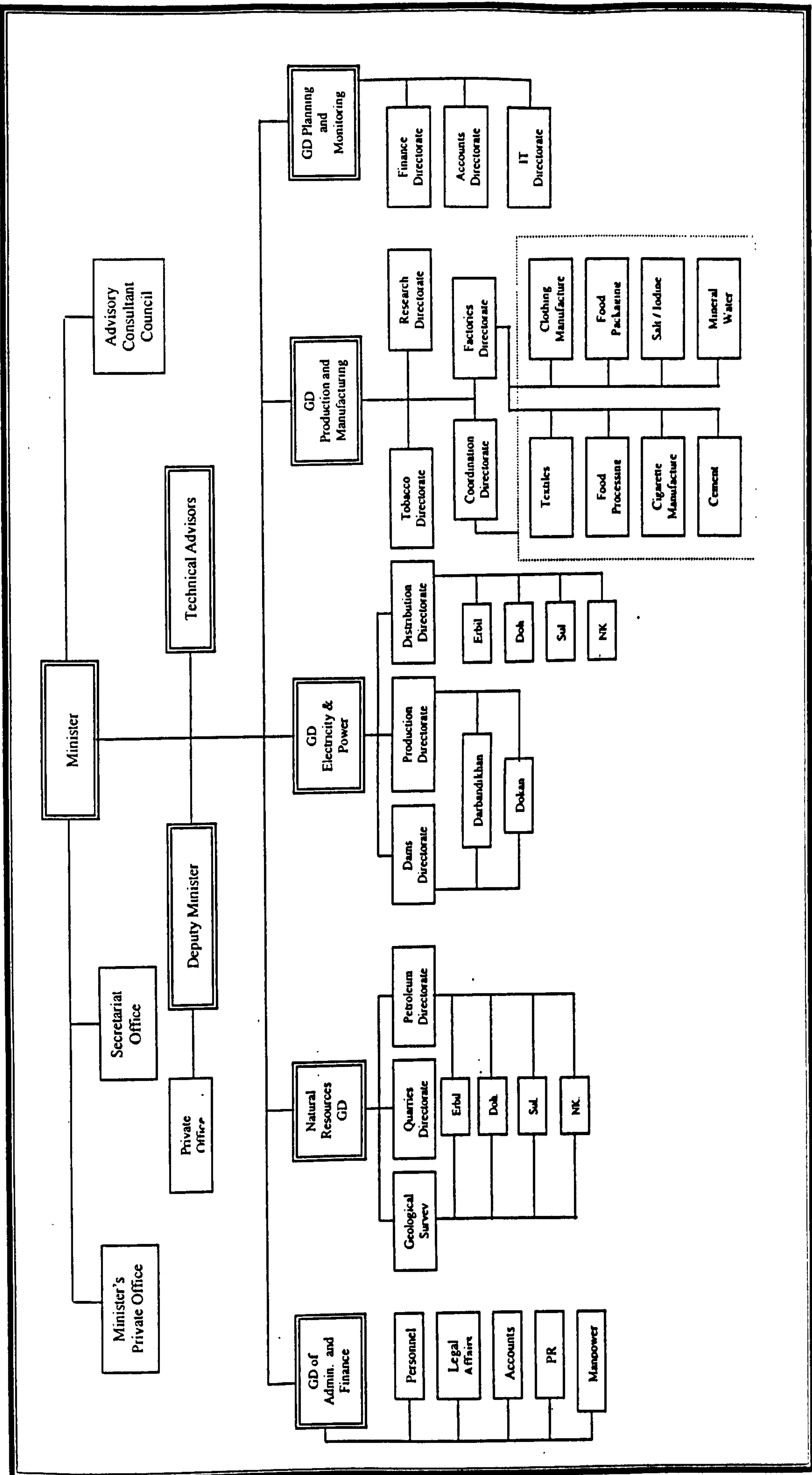
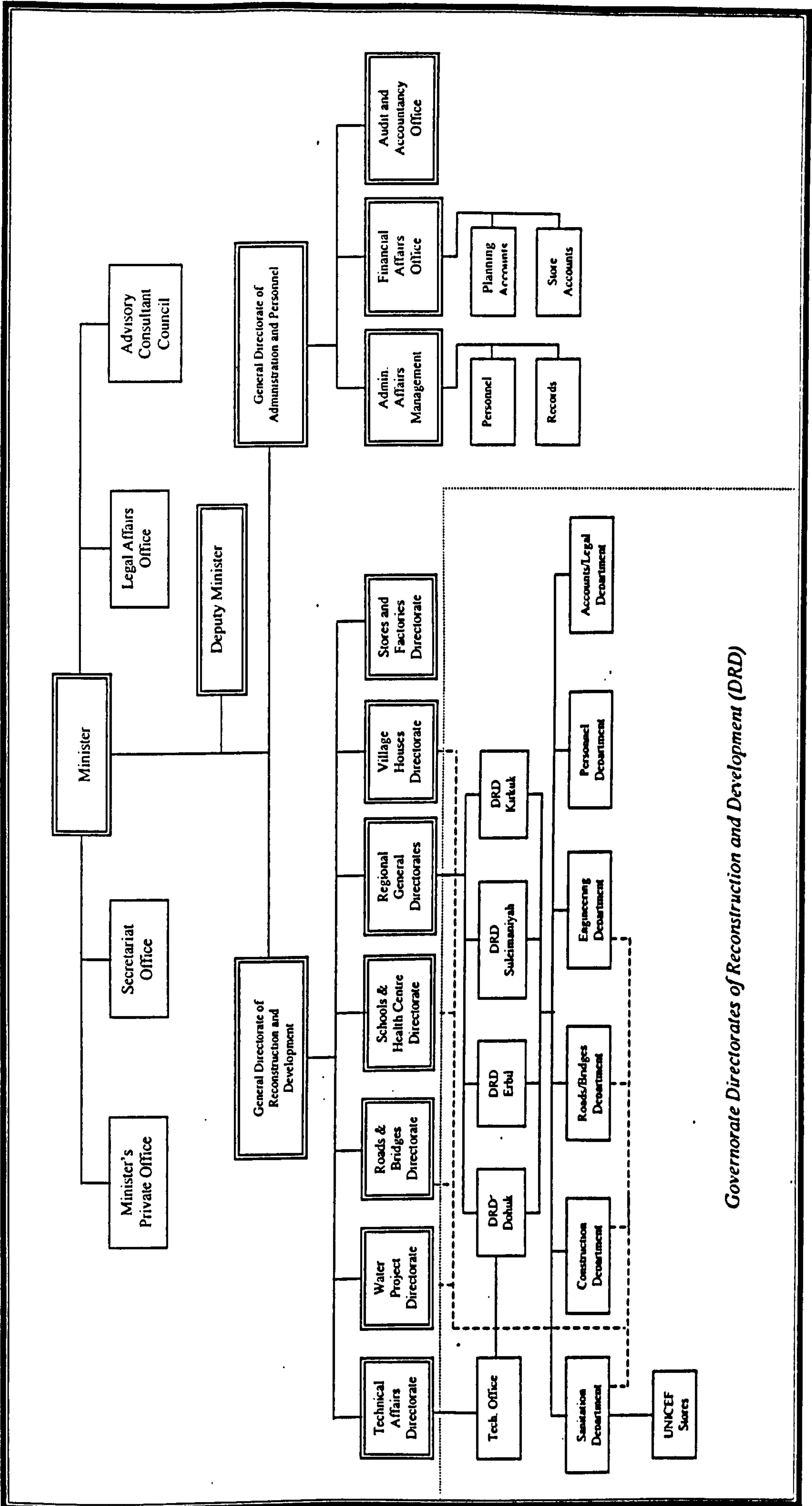

Figure A5:11: Ministry of Industry and Power



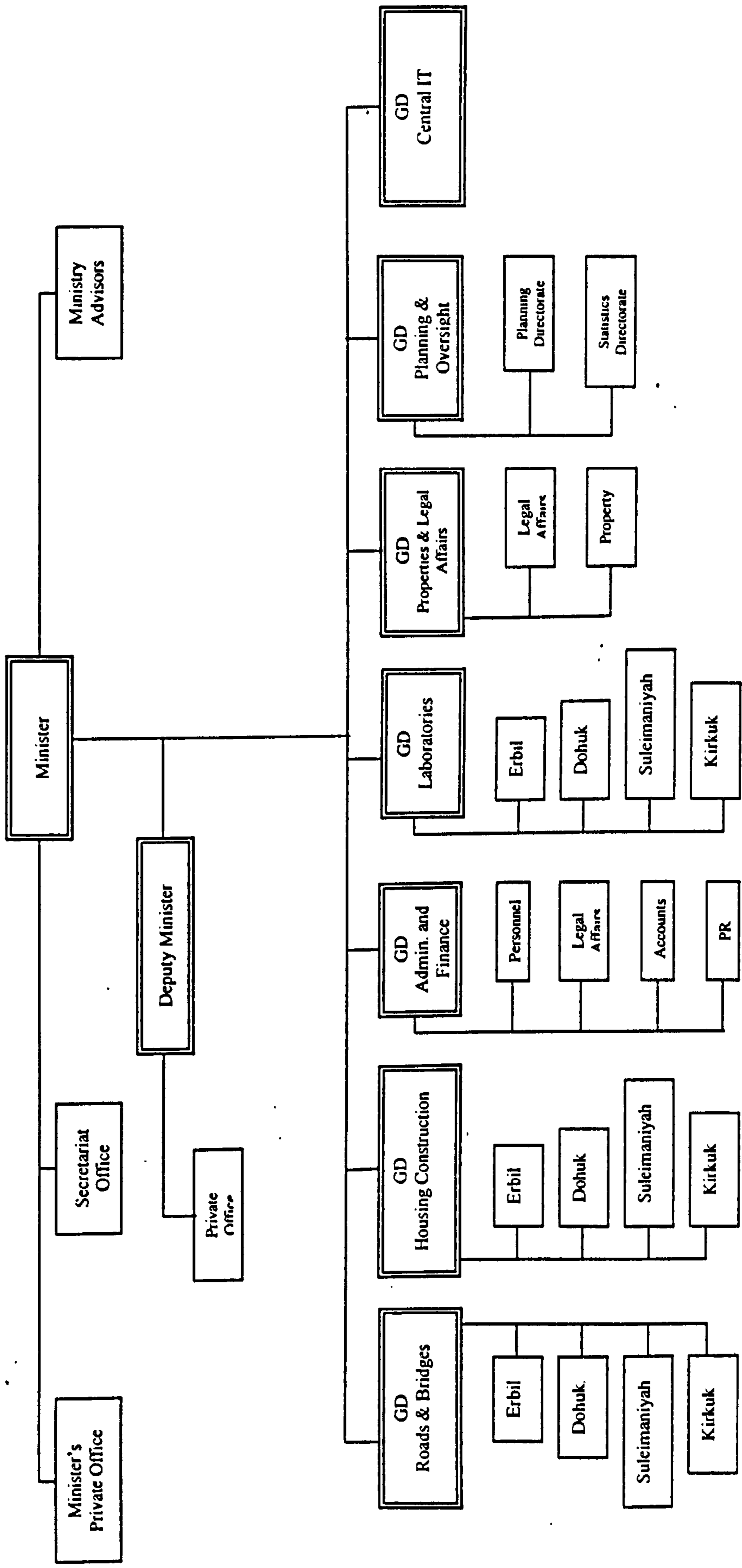

**Figure A5:12: Ministry of Reconstruction and Development**



*Governorate Directorates of Reconstruction and Development (DRD)*

**Figure A5:13: Ministry of Public Works & Housing**





**Figure A5:14: Ministry of Transportation & Communication**

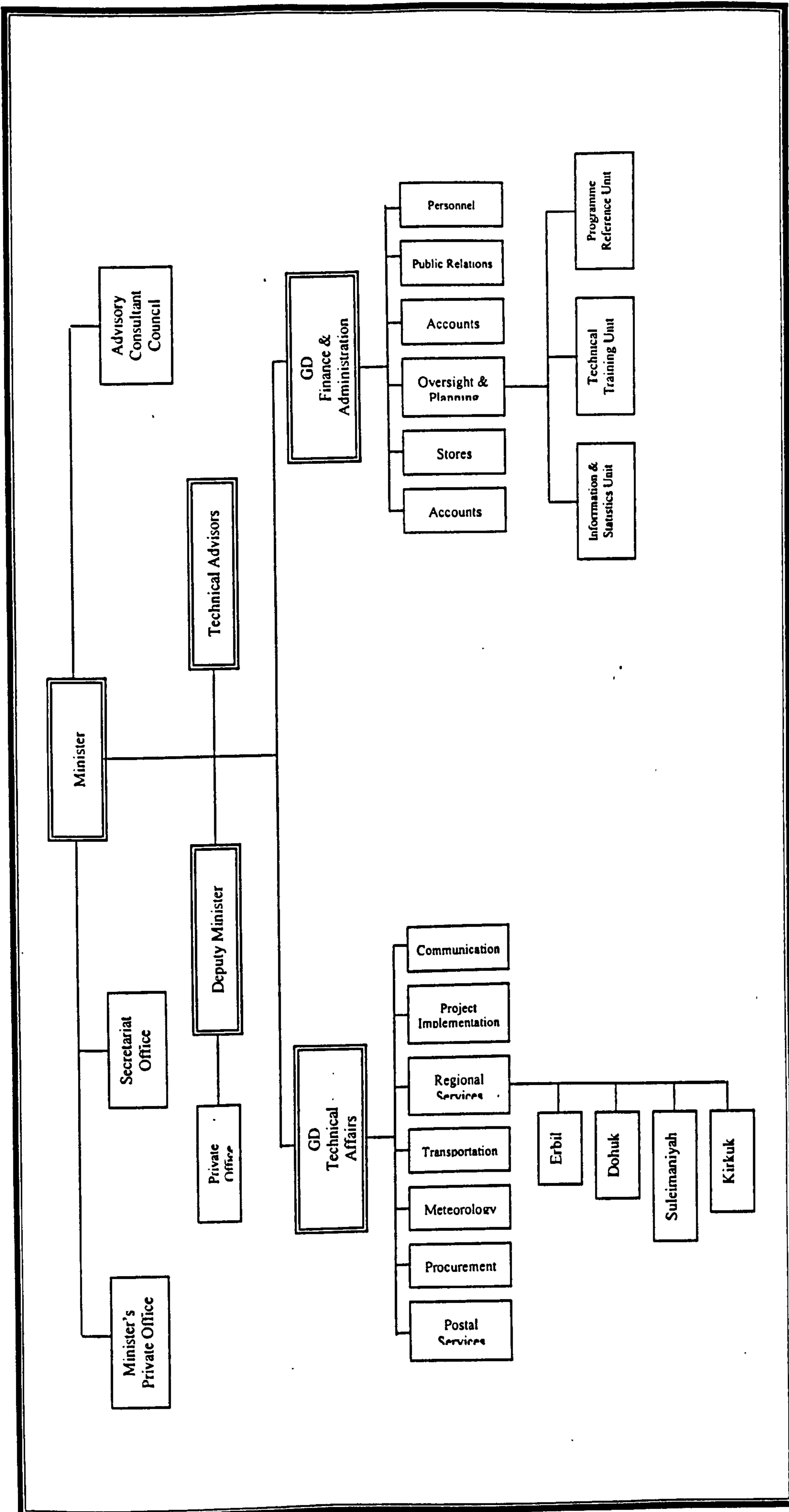

## **Appendix 6: Selected Ministry Records of the Kurdistan Regional Governments**

### **Kurdistan Regional Government, Erbil**

#### **Programme 1: Ministry of Municipalities and Tourism Halabja Street Project, Erbil**

1. Presidency of Erbil Municipality to MoMT. 26 March 1997 (2475). Propose project, provided fieldwork to support proposal.
2. Presidency of Erbil Municipalities (Technical Department). 23 April 1997. Form preliminary budget.
3. MoMT (GD of Planning) to Council of Ministers (GD Planning). 27 April 1997 (1639). Subject: Request project.
4. Council of Ministers (Divan) to MoFEA. 23 June 1997 (2599). Discussion of project and agreement on spending Copied to MoMT.
5. MoFEA. 6 July 1997 (3749). Allocation of funds (548,000 OID).
6. MoFEA (GD of Finance) to Kurdistan Regional Bank. 6 July 1997 (537). Subject: Funding, according to 2599.
7. MoMT (GD of Planning) to GD Municipality. 12 July 1997 (3186). Subject: Funding notification.
8. MoMT (GD Planning). 20 July 1997 (3284). Subject: Ministerial Order. Formation of Implementation Committee. Copied to Council of Ministers; MoFEA; Governorate of Erbil; Ministers Office; GD Finance; GD Municipality; GD Planning; Presidency of Erbil Municipality.
9. Ministry Project Committee. 2 August 1997. Budget for implementing Halabja Street project.
10. MoMT (GD Municipality, D of Planning) to Presidency of Erbil Municipality. 7 August 1997 (2671). Subject: Recommendation of Audit team members.
11. MoMT (GD Municipality, D of Planning). 12 August 1997 (2708). Subject: Implementation Order. Moving staff to Halabja Street Project. Copied to GD Planning.



12. MoMT (GD Planning) Ministerial Order. 25 August 1997 (4023). Decision to form a committee to evaluate and audit the budget of the project. Composed of three engineers. Copied to Ministers Office; Deputy Ministers Office; GD Municipality; GD Planning; GD Finance.
13. Ministry Project Audit Committee meeting. 28 August 1997 (4123). Discussion of the budget and market prices.
14. MoMT (GD Finance) to MoFEA (GD Finance). 3 September 1997 (4192). Subject: Defence of funding increases. Copied to GD of Municipalities; GD Planning; GD Finance.
15. Ministry Project Committee Budget audited by MoFEA. 23 November 1997 (4023).
16. MoFEA to Presidency of Erbil Municipality. 29 November 1997 (7607). Subject: Granting of funding (157,635 OID).
17. MoMT (GD Planning). 3 November 1997. Visited Halabja Street.
18. MoMT (GD Planning) to Central Laboratory of Erbil. 4 November 1997 (5500). Subject: Request testing of tarmacadam for project. Copied to Presidency of Erbil (don't pave the streets); Implementation Committee.
19. MoMT(GD Planning) to GD Municipality. 4 November 1997 (5511). Subject: Note on visit to Halabja Street. Copied to GD of Planning.
20. MoFEA (GD of Finance and Public Spending) to Kurdistan Regional Bank. 29 November 1997 (7607). Subject: Release of funds to the MoMT (Erbil Presidency). Copied to Council of Ministers; MoMT; Presidency of Erbil Municipality; Rafeedain Bank; GD Planning; GD Finance
21. GD of Planning (MoMT) to GD of Municipality. 8 December 1997 (6146). Subject: Funding. Notification of funding. Copied to Minister's Office; GD of finance; GD of Planning.

**Programme 2: Ministry of Municipalities and Toursim, Erbil  
General Directorate of Water and Sewerage  
Artesian Well Programme, Erbil City.**

1. GDWS to MoMT to MoFEA; 30 December 1997 (5295) requesting funding for programme.

2. Residents of Kurdistan Quarter of Erbil to Technical Department of DWS(E). 15 January 1998. Complaint of lack of water to 500 families. (Includes petition).
3. DWS(E)poss. and rights to Presidency of Erbil Municipality; 19 January 1998. Informing of proposal.
4. DWS(E) to Presidency of Erbil Municipality (Planning); 20 January 1998 (196). Proposal for location of well.
5. Presidency of Erbil Municipality (Planning) to DWS(E); 21 January 1998 (302). Response to proposal, rejected by municipality. Copied to planning dept. and Dept. Planning.
6. DWS(E) to GDEducation(E); 24 January 1998. Notification on location near to school. Copied to tech. dept.; project engineer.
7. DWS(E) tech. dept. to DWS(E); 25 January 1998 (242). Defence of well location and request for permission to proceed.
8. GDEducation(E)buildings to DWS(E); 2 February 1998 (1428). Agreement to DWS digging outside school. Copied to planning, building.
9. DWS(E)poss. and rights to GDWS. 9 February 1998 (353). Note to GDWS that DWS(E) approached MoFEA for funds. Copied to tech. dept.; accounts; audit; possession and rights.
10. Contractor to DWS(E); 10 February 1998. Proposal from well-digging department MoAI.
11. WDD(MoAI) to MoMT. 10 February 1998 (97). Details of proposal and equipment. Copied to DWS(E) technical dept.; DWS(E) accounts; follow-up.
12. WDD(planning) to DWS(E) accounts; 10 February 1998 (98). The cost of the wells, agreeing with doc. 97. Copied to DWS(E) technical dept.; planning and follow-up; accounts; general well file.
13. DGWS to DWS(E) Accounts; 14 February 1998. Evaluation from contractors to audit. (685). Copied to DWS(E).
14. MoFEA to MoMT; 24 February 1998 agreeing to supply funds. (937).
15. GDWS (accounts) to DWS Erbil, 24 March 1998. Supplying 17,200 OJD for implementing work. Referenced to budget of 1998. (1342).  
Copied to GD of Planning MoMT, Finance MoMT. Signed Nihad Izzadin Al-Alim, GDWS.
16. DWS (Erbil) to contractor; 28 March 1998 (853). Signed Azad Dizai, DWS(E).  
Copied to: Technical Department; Audit; Follow-up;



17. Contract signed between Well-digging department of MoAI and DWS(E). 28 March – 1 April 1998.

**Programme 3: Ministry of Health and Social Affairs  
General Directorate of Health  
Renovation of Operating Theatre in Martyr Mulazim  
Karim Hospital, Salahadin**

1. MoHSA (Office of General Management) to MoFEA. 18 May 1997 (1450). Subject: Presentation of surveys with budgets. Copied to GDHERbil.
2. MoFEA to Council of Ministers. 25 May 1997 (2/10/2678). Subject: Presentation of request to CoM. Copied to MoHSA (GDHERbil).
3. CoM to MoFEA. 12 June 1997 (2464). Subject: Agreement on funds. Copied to GDHERbil; CoM; Erbil Treasury.
4. MoFEA (GD Finance) to MoHSA (GD Accounting). 23 June 1997 (20/10/3437). Subject: Notification of agreement on funding (539,580 OID).
5. MoHSA (GMO) to GDHERbil. 26 July 1997 (2321). Subject: Request for details of programme of work from Minister.
6. MoHSA (GMO). 31 July 1997 (4294). Subject: Administrative Order no. 2/2/2. Decision to form a committee, according to 3437 and 2321, to oversee the renovation project. Copied to Erbil Treasury.
7. MoHSA. 25 October 1997 (1330). Subject: Administrative Order. Completion of project. Composed of members of engineering department. Copied to MoHSA; Dept. Eng.
8. MoHSA (GDHERbil). 16 November 1997 (7013). Subject: Administrative Order. Completion of work and identification of hand-over committee.

**Programme 4: Ministry of Health and Social Affairs  
General Directorate of Health  
Renovation of Erbil Juvenile Jail**

1. CoM to MoFEA. 15 June 1997 (2544). Release of funds to MoHSA.
2. MoFEA to MoHSA (Accounts). 29 June 1997 (2/10/3598). Subject: Funding work according to survey results (927,410 OID).

3. General Management of Social Reform to MoHSA. 17 July 1997 (2201). Subject: request for increased funds.
4. MoHSA (GMO) to General Management of Social Reform. 14 August 1997 (2589). Subject: Agreement on increase of funds.
5. MoHSA (Social Reforms Office). 2 September 1997 (220). Subject: Administrative Order 220. Decision made to form a committee to oversee the renovation programme. Copied to MoHSA; Erbil Treasury.
6. MoFEA. 5 November 1997 (1/10/7009). Subject: Order no. 181. Addition to budget of MoHSA.
7. MoHSA. 30 December 1997 (398). Establishment of committee. First field trip to Erbil juvenile jail. Copied to MoHSA; Juvenile Rehabilitation Department.

**Programme 5: Ministry of Agriculture & Irrigation (Erbil)**  
**General Directorate of Irrigation and Dams**  
**Eski Kelek Project**

1. D I&D to Erbil Governorate (Flood Committee), 17 November 1993 (8090). Subject: Informing of change of river conditions due to quarrying on Zab.
2. D I&D to GD I&D(E), 29 November 1993 (8383). Subject: Request to build flood protection, plans provided by engineers.
3. GD I&D to D I&D, 1 December 1993 (6958). Subject: Request to downsize requirements of 8383.
4. D I&D to GD I&D, 6 December 1993 (8547). Subject: Notification of flood in Taqtaq.
5. GD I&D to D I&D, 20 December 1993 (7317). Subject: Reply to notification of flood in Taqtaq and provisional plans for flood defence.
6. GD I&D to Governor, 9 August 1994 (479). Subject: Request for assistance to be provided to Erbil Flood Committee from Council of Ministers to build 3 levels of flood protection at Erbil, Kelek and Taqtaq (budgets provided of 138,000 OID), and asking for illegal quarrying to be stopped as it threatens Eski Kelek Dam.
7. Council of Ministers, 23 April 1997 (1579). Subject: Requesting formation of committee.



8. GD I&D to Governorate Flood Committee, 28 April 1997 (383). Subject: Request appointment of flood engineer. Appointment of Flood Committee according to PM's request of 1579
9. D Implementation of GD I&D, 3 May 1997 (389). Subject: Management Order. Formation of cubit committee to censor instruments.
10. GD I&D, 6 May 1997 (409). Subject: Management Order, commencement of repairing dams.
11. D Implementation of GD I&D to MoPI, 6 May 1997 (411). Subject: Request for fuel for digging machines.
12. D Implementation of GD I&D to Governorate Flood Committee, 12 May 1997 (345). Subject: Nearing completion of work but require a bulldozer and need Governor to obtain it from Erbil Municipality.
13. Governorate (Locality Engineers), 14 May 1997 (1352). Subject: Management Order. Appointment of engineer to implement flood protection programme on Zab.
14. GD I&D to Governor, 23 May 1997. Subject: Notification of completion, provision of budget.
15. D Implementation of GD I&D, 1 June 1997 (49). Subject: Management Order, Notification of completed work.
16. GD I&D to MoAI (Minister's Bureau), 3 July 1997 (648). Subject: Notification of successful completion of work under budget.
17. Council of Ministers (Planning) to MoFEA, 2 August 1997 (3252). Subject: Spending 364,887 OID on soil dams on Zab River from MoAI budget.
18. MoFEA (GD Finance) to Rafidain Bank, 25 August 1997 (4957). Subject: Release of 1,622, 250 OID (budget provided) from MoAI.

**Programme 6: Ministry of Agriculture & Irrigation (Erbil)**  
**General Directorate of Livestock**  
**Establishment of Livestock Centre in Erbil**

1. D Vet and Livestock to GD Vets and Livestock, 4 November 1996 (352). Subject: Request of supply of land.

2. MoAI (GD Vets & Livestock) to MoAI (Minister's Bureau), 6 November 1996 (204). Subject: Request of supply of land to HDI.H. Copied to GD, D of Planning, Legal Affairs.
3. Ministerial visit to NGO (HDI.H) cow breeding programme, 30 November 1996.
4. MoAI (GD Vets & Livestock) to MoAI (Minister's Bureau), 4 December 1996 (328). Subject: Positioning of new project. Copied to Research Directorate, GD Agr. Services, D of vets, D of Livestock.
5. MoAI (D of Planning of GD Vets & Livestock) to MoAI (D of Accounts), 23 December 1996 (346). Subject: Request for 65,000 OID to be released from MoFEA.
6. MoAI (GD accounts) to MoFEA (GD Finance), 29 December 1996 (1752). Subject: Request for 655,000 OID from budget of GD Vets & Livestock.
7. MoFEA (GD Finance) to Cabinet Planning Department, 7 January 1997 (32). Subject: Requesting final decision on MoAI programme.
8. MoAI (D of Audit of GD Divan) to MoAI (GD Vets & Livestock), 20 January 1997 (207). Subject: Approval of Minister to 328. Requesting the formation of a committee to oversee spending. Copied to D of Audit and D of Accounts.
9. Council of Ministers (Planning) to MoFEA, 20 January 1997 (273). Subject: Notification to release funds (500,000 OID) from MoAI according to the audit at convenience.
10. Council of Ministers (Planning) to MoAI (Accounts), 29 January 1997 (372). Subject: Notification of release of funds.
11. MoAI (NGO relations) to GD Vets & Livestock, 17 February 1997 (502). Subject: Minutes of meeting with HDI.H. Copied to Ministry of Humanitarian Aid and Cooperation, Deputy Minister's Office, GD Agr. Services, D Planning.
12. HDI.H to GD Vets & Livestock, 29 June 1997 (239). Subject: Invitation to view project.
13. HDI.H to MoAI (Minister's Bureau), 30 June 1997 (40). Subject: Draft of cooperation protocol.
14. MoFEA to Council of Ministers (Planning), 1 July 1997 (23). Subject: Request for information to release funds.
15. GD Vets & Livestock to HDI.H, 2 July 1997. Subject: Questions about programme.



16. HDI.H to GD Vets & Livestock, 3 July 1997 (241). Subject: Clarification of points of 2 July.
17. MoAI (D of Livestock of GD Vets & Livestock) to HDI.H, 5 July 1997 (837). Subject: Request for more information.
18. MoAI (D of Livestock of GD Vets & Livestock) to MoAI (Relations Committee), 12 July 1997. Subject: Private letter regarding negotiations.
19. MoAI (D of Livestock of GD Vets & Livestock) to MoAI (Relations Committee), 3 August 1997 (10). Subject: Annex to official letter of 12 July.
20. MoAI (D of Planning of GD Vets & Livestock) to MoAI (Minister's Bureau), 12 July 1997 (8). Subject: Request for information.
21. MoAI (D of Planning of GD Vets & Livestock) to MoAI, 13 July 1997 (886). Subject: Request contact with Ministry of Humanitarian Aid and Cooperation regarding more information about HDI.H.
22. MoAI (D of Livestock of GD Vets & Livestock) to MoAI (Relations Committee), 12 August 1997 (1016). Subject: Minutes of meeting.
23. Prime Ministerial Decision to MoAI, 23 September 1997. Subject: Order to receive programme from HDI.H.
24. MoAI (D of Livestock of GD Vets & Livestock) to GD, 28 September 1997 (1283). Subject: Requests for clarification of costs and request for land.
25. MoAI (Accounts, GD Vets & Livestock) to GD Divan, 29 September 1997 (1296). Subject: Request to inform MoFEA of need for 100,000 OI for fodder and barley.
26. MoAI (D of Administration of GD Vets & Livestock), 1 October 1997 (1303). Subject: Administrative Order. Notification of formation of a committee according to PM's and M's instructions.
27. MoAI (D of Livestock of GD Vets & Livestock) to HDI.H, 8 October 1997 (1353). Subject: Negotiation of contract.
28. MoAI (D of Livestock of GD Vets & Livestock) to MoAI (Minister's Adviser), 8 October 1997 (1352). Subject: Information regarding land provision.
29. MoAI (Minister's Bureau) to MoAI (D of Livestock of GD Vets & Livestock), 13 October 1997. Subject: Discussion on handover.
30. MoAI (D of Livestock of GD Vets & Livestock) to UNICEF, 14 October 1997 (1395). Subject: Request for pumps to provide water to agricultural land to supply fodder.

31. MoAI (D of Livestock of GD Vets & Livestock) to D of General Education and Teaching, 14 October 1997 (1389). Subject: Request for list showing numbers of children to supply milk and eggs to at school. Copied to D of Planning, D of Livestock.
32. MoAI (D of Livestock of GD Vets & Livestock) to MoAI (Minister's Bureau), 15 October 1997 (1396). Subject: Information to Minister regarding hand-over of programme.
33. MoAI (D of Accounts of GD Vets & Livestock) to MoAI (special office), 27 October 1997 (1477). Subject: Request for more money to be put to MoFEA.
34. MoAI (Minister's Bureau) to GD Vets & Livestock, 27 October 1997 (3881). Subject: Agreement on budget. Replying to 1396.
35. MoAI (D of Accounts of GD Vets & Livestock) to MoAI (Minister's Bureau), 10 November 1997 (1564). Subject: Information regarding meeting.
36. MoAI (D of Accounts of GD Vets & Livestock) to MoAI, 12 November 1997 (1570). Subject: Review of budget (1,156,567 OID).
37. MoAI (D of Planning of GD Vets & Livestock) to MoAI (Legal Affairs), 16 November 1997 (1581). Subject: Review of contract.
38. MoAI (Adviser's Bureau) to MoAI (GD Vets & Livestock), 14 May 1998. Subject: Provision of report on Livestock Project.
39. MoAI (GD Vets & Livestock) to MoAI (Adviser's Bureau), 18 June 1998 (1158). Subject: Reply to report. Copied to Minister's Bureau, Deputy's Bureau, D of Planning, D of vets, D of Livestock.
40. MoAI (D of Planning and Pursuance) to MoAI (GD Vets & Livestock), 17 June 1998 (2184). Subject: Recommendations and instructions from seeing draft of 1158.
41. MoAI (GD Vets & Livestock) to MoAI (D of Planning and Pursuance), 20 June 1998 (1218). Subject: Reply to 2184. Copied to Minister's Bureau, Deputies Bureau, Adviser's Bureau, D of vets., D of Livestock, D of Planning.

**Kurdistan Regional Government, Suleimaniyah**

**Programme 1: Ministry of Reconstruction and Development  
(Suleimaniyah)  
Directorate of Reconstruction and Development**



### **Sheney Village Water Project (Qala Diza)**

1. MORAD (GDRD, DRD(S)) to GDRD, 30 July 1996 (1423). Subject: Implementation of Sheney water project. Provision of survey, and request for approval of named implementation committee. Copied to: Suleimaniyah Treasury (although money supplied by Mam Jalal), Water Dept. of DRD, DRD accounts.
2. Director, DRD (S) to Jalal Talabani, 2 July 1996. Subject: Preparation complete for implementation of project. Now awaiting sum of 84,087 OID from Mam Jalal.
3. MORAD (GDRD, DRD(S)) to UNICEF(S), 30 July 1996. Subject: Proposal of DRD(S). Agreement on implementation of project, supply of materials.
4. DRD(S) Water to GDRD, 11 August 1996 (1553). Subject: Request for car tires for vehicle transporting building materials. Copied to technical department, water, mechanics, accountants.
5. DRD(S) to Suleimaniyah Governor, 24 February 1997 (535). Subject: Reporting theft of pipes from village.
6. Suleimaniyah Governorate to Pishdar Mudir al-Nahiya (Water Directorate), 16 March 1997 (446). Subject: Investigation into stolen water pipes from Sheney. Copied to Rapareen Centre No. 8 of PUK; DRD(S).
7. DRD(S) to UNICEF(S), 14 September 1997 (203). Subject: Report to UNICEF regarding theft of pipes.
8. UNICEF(S) to DRD(S), 16 September 1997 (053). Subject: Acknowledgement of 203 and note that material should have been guarded [even though it was KDP looting].
9. DRD(S) to MORAD, 13 October 1997 (2742). Subject: Notification of progress.
10. DRD(S), 15 October 1997. Subject: Agreement of contractor, Mr. Khalid. Handed over all pipes and fittings.
11. DRD (Water), 14 November 1997. Subject: Notification of good work.
12. MORAD (Diwan) to DRD(S), 17 November 1997 (1130). Subject: Notification of funds.
13. MORAD (GDRD, DRD(S)), 9 December 1997 (3371). Subject: Administrative Order. Hiring of vehicle at 5,000 OID per month for implementation committee. Copied to Personnel; accounts, DWS.

14. GDRD, DRD(S) to MORAD, 9 December 1997 (3397). Subject: Completion of project, seeking to spend 30,000 OID on further projects. Copied to: technical dept.; water; accountants.
15. MORAD (Divan) to DRD(S), 17 December 1997 (1230). Subject: Granting of extra funds.
16. MORAD (GDRD, DRD(S), personnel), 22 December 1997 (3525). Subject: Administrative Order. Note of approval of 1230 to spend an extra 30,000 OID. 20,000 OID on statistics, 10,000 OID on water project. Copied to GDRD; personnel; accountancy.
17. MORAD (GDRD, DRD(S)), 25 December 1997 (3563). Subject: Administrative Order. Vehicle contract extension.
18. DRD(S), 25 December 1997 (3565). Subject: Administrative Order. From MORAD (Diwan) 1130, decided to award bonuses to 2 engineers.
19. Sheney spring owners, n.d. Subject: A Treaty. Those villagers who own the springs of Chawra Biley offer them to the people of the village and will not raise any problems.

**Programme 2: Ministry of Reconstruction and Development  
(Suleimaniyah)  
Construction of Zerinek Health Centre**

1. Zerinek Anjuman to Minister of Reconstruction and Development, n. d. Subject: Requesting construction of a camp.
2. Above letter redirected to DRD(S).
3. DRD(S) to MORAD, n. d. Subject: Notes on survey of Zerinek with DH(S), to assess the house correctly (for use as a health centre).
4. MORAD to Council of Ministers, 16 August 1997 (692). Subject: Requesting funds for Zerinek.
5. Council of Ministers (Kosrat) to MoFEA, 19 August 1997 (1734). Subject: Securing of funds for MORAD for Zerinek (28,230 OID). Copied to MORAD.
6. MOFEA(GDF) to MORAD, 23 August 1997 (4611). Subject: Agreed to supply funds (from deputy-minister). Copied to Council of Ministers; Treasury of Suleimaniyah.



7. MORAD (Diwan) to DRD(S), 25 August 1997 (738). Subject: Notification of agreement on funds for Zerink. Permission to commence work.
8. DRD(S) (technical dept.) to MORAD, 2 October 1997 (2603). Subject: Completion of survey of health centre buildings.
9. DH(S)(engineering) to DRD(S), 10 November 1997 (57). Subject: Request for names of staff.
10. DRD(S) (Buildings), 10 November 1997 (3407). Subject: Administrative Order. Notification of supervising

**Programme 4: Ministry of Reconstruction and Development  
(Suleimaniyah)  
General Directorate of Reconstruction and Development  
Directorate of Reconstruction and Development  
(Suleimaniyah)  
Jeshana Village Sanitation Project (Sarchinar)**

1. Jeshana Village to DRD(S), n. d.; Subject: Petition for watsan project.
2. DRD(S) (Water), 13 May 1997 (1206). Subject: Administrative Order. Formalization of working relationship between DRD(S)Water and PWJ.
3. DRD(S), 28 May 1997 (1341). Subject: Administrative Order. Commencement with water project with aid of PWJ.
4. DRD(S) (Water), 31 May 1997 (1344). Subject: Administrative Order. Naming manager of programme.
5. DRD(S) (Water) to PWJ, 15 June 1997 (1447). Subject: Provision of report.
6. Jeshana Villager to DRD(S), 20 June 1997. Subject: Donating water pool to the project.
7. Contract between villager and village regarding use of water source
8. DRD(S) to PWJ, 25 June 1997 (1536). Subject: Defence of quality of work by DRD(S) for PWJ at Jeshana.

**Programme 5: Ministry of Health and Social Affairs (Suleimaniyah)  
General Directorate of Health  
Reconstruction of Chwarta General Hospital**

1. MoHSA (GDHSul(finance)) to MoFEA. 25 December 1996 (5880). Subject: Provision of assessment of the reconstruction needs of Chwarta Hospital. Request of funds (31,500 OID).
2. MoFEA (GD Finance) to MoHSA (GDHSul). 22 February 1997 (452). Subject: Agreement on funds. Copied to Directorate of Suleimaniyah Treasury.

**Programme 6:            Ministry of Municipalities and Tourism (Suleimaniyah)**  
**Directorate of Water and Sanitation**  
**Wolloba and Sheikh Abbas Water Project**

1. Outbreak of diarrhoea at Wolloba primary school.
2. MoHSA, Suleimaniyah Health Office Dept. of health protection, 21 July 1997. Subject: biological and chemical examination of water.
3. Wolloba primary school to DWS, 26 July 1997 (231). Subject: Pupil's health. 1570 pupils drinking substandard water.
4. DWS to SCF, 26 July 1997. Subject: Proposal for funding.
5. SCF agree, 17 August 1997. SCF contribute US\$ 47,025.
6. DWA (technical dept.) to MMT (GDWS), 19 August 1998 (5739). Subject: Implementation of Wolloba and Sheikh Abbas water project after agreement with SCF. Appointed oversight committee. Copied to MMT (GD Plan).

**Programme 7:            Ministry of Agriculture & Irrigation (Suleimaniyah)**  
**Purchase of Saplings for Koysinjaq**

1. MoAI (D of Woodlands and Orchards of GD Services & AA) to MoFEA (GD Finance), 5 April 1997 (480). Subject: Requesting approval to spend 5000 OID for GDA Erbil to buy saplings. Copied to Minister's Bureau, GD Services & AA, GDA Erbil.
2. Supplier to GDA Erbil, 20 April 1997 (477). Subject: Invoice for 5000 saplings.
3. MoFEA (GD Finance) to MoAI (GD Services & AA), 28 April 1997 (1729). Subject: Approval of 480. Copied to Directorate Erbil Treasury.
4. MoAI (D of Accounts of GD Divan) to GDA Erbil, 29 April 1997 (594). Subject: Notification of approval of funds. Copied to Directorate Erbil Treasury.



5. GDA Erbil to supplier, 30 April 1997. Subject: Settling of invoice..
6. Erbil Treasury to GDA Erbil, 4 August 1997 (65). Subject: Release of funds.

## Reference List 1: Books, Articles, Reports, Theses

- Abd al-Jabbar, Faleh (1992) "Why the Uprisings Failed." *Middle East Report*, (May-June, 1992): 2-14.
- Abdulghani, Jasim M. (1984) *Iraq and Iran: The Years of Crisis*. Baltimore: Johns Hopkins University Press.
- Abdul Rahman, Sami (1981) *Al-Badiel Al-Thawry fi Al-Harakah Al-Taharuryah Al-Kurdiyah* (The Revolutionary Alternative in the Kurdish Liberation Movement).
- Adamson, David (1964) *The Kurdish War*. London: George Allen & Unwin.
- Agnew, John A., (ed.) (1998) *Geopolitics: Re-Visioning World Politics*. London: Routledge.
- Aguado, Laura Donnadiou (1987) "The Kurds in the Middle East: Struggle for National Liberation." *Ethnic Studies Report* 5, no. 2 (July 1987): 9-17.
- \_\_\_\_\_, (1990) "The National Liberation Movement of the Kurds in the Middle East," in Ralph R. Premdas, S. W. R. De A. Samarasinghe, and Alan B. Anderson, (eds.), *Secessionist Movements in Comparative Perspective*. International Centre for Ethnic Studies; London: Pinter Press.
- Ahmad, Gaylani Said (1999) *Al-mabadi al-qanunia fi qadha mahukuma tamayays aqalim Kurdistan al-Iraq as-sanwat 1993-1998*. (Law Principles in Court of Cassation Verdicts of Kurdistan Region, Iraq). Erbil.
- al-Kanaani, Nauman M (1965) *Limelight on the North of Iraq*. Baghdad: Dar al-Jumhuriya.
- al-Khafaji, Isam (1992) "State Terror and the Degradation of Politics in Iraq." *Middle East Report*, (May-June, 1992): pp. 15-21.
- \_\_\_\_\_, (1996) "The Destruction of Iraqi Kurdistan," *Middle East Report*, no. 201, pp. 35-38, 42.
- Allardt, E., and Y. Littunen (1964) *Cleavages, Ideologies and Party Systems*. Helsinki: The Academic Bookstore.



- Almond, Gabriel A. (1960) "Introduction: A Functional Approach to Comparative Politics," in Gabriel Almond and James Colman, (eds.), *The Politics of Developing Areas*. Princeton, NJ: Princeton University Press.
- \_\_\_\_\_, (1968) "Comparative Politics," in Sills, (ed.), *International Encyclopaedia of the Social Sciences*, vol. 13, pp. 331-336. New York: Macmillan.
- Almond, Gabriel A. and James Colman (eds.) (1960) *The Politics of Developing Areas*. Princeton, NJ: Princeton University Press.
- Almond, G. A., and G. B. Powell (1966) *Comparative Politics: A Developmental Approach*. Boston, Mass.: Little, Brown & Co.
- Almond, Gabriel A., G. B. Powell, and R. J. Mundt (1993) *Comparative Politics*. New York: Harper Collins.
- Alnasrawi, Abbas (1994) *The Economy of Iraq: Oil, Wars, Destruction of Development and Prospects, 1950-2010*. Westport, Conn.: Greenwood Press.
- Amin, Nawshirwan Mustafa (1993a) *Al-Akrad wa Al-Barliman* (The Kurds and Parliament). Erbil: PUK Publications.
- \_\_\_\_\_, (1993b) *Hukumat Kurdistan: Kurd la Gama Soviet da* (The Government of Kurdistan: The Kurds in the Soviet Game). Utrecht: KIB Press.
- \_\_\_\_\_, (1998) *Pentzakan Yaktra Ashkya* (Fingers that Crush Each Other: Political Events in Iraqi Kurdistan From 1979-1983). Suleimaniyah.
- \_\_\_\_\_, (1999) *Khowlanawa la Nawbaznada: Diwa Nawaway Rowdawakany Kurdistanî Iraq, 1984-1998*. (Going Around in Circles: The Inside Story of Events in Iraqi Kurdistan, 1984-1988). Berlin: Awadani e. V.
- Amin, Rizgar, and Kerim Yildiz (1996) *Internal Conflict and the Humanitarian Response in Iraqi Kurdistan*. London: Kurdish Human Rights Project.
- Amnesty International (1995) *Iraq: Human Rights Abuses in Iraqi Kurdistan Since 1991*. November 1995. London.

- Anderson, Ewan W. (1988) *Strategic Minerals: The Geopolitical Problem for the United States*. Praeger Publishers.
- \_\_\_\_\_, (1993) *An Atlas of World Political Flashpoints: A Sourcebook of Geopolitical Crisis*. London: Pinter Reference.
- \_\_\_\_\_, (1999) "Geopolitics: International Boundaries as Fighting Places," in Colin S. Gray and Geoffrey Sloan, (eds.), *Geopolitics: Geography and Strategy*. London: Frank Cass.
- Anderson, Ewan W., Ivars Gutmanis, and Liam Anderson (2000) *Economic Power in a Changing International System*. London: Pinter.
- Anderson, Ewan W., and Khalil H. Rashidian (1991) *Iraq and the Continuing Middle East Crisis*. London: Pinter Press.
- Andrews, F. David, (ed.) (1982) *The Lost Peoples of the Middle East: Documents of the Struggle for Survival and Independence of the Kurds, Assyrians, and Other Minority Races in the Middle East*. Salisbury NC: Documentary Publications.
- Apter, David E. (1958) "A Comparative Method for the Study of Politics," *American Journal of Sociology*, Vol. LXIV, No. 3, (November), pp 221-237.
- \_\_\_\_\_, (1965) *The Politics of Modernization*. Chicago, Illinois: Chicago University Press.
- \_\_\_\_\_, (1991) "Institutionalism Reconsidered," *International Social Science Journal*, Vol 129, pp. 463-481.
- Arfa, Hassan (1966) *The Kurds: An Historical and Political Study*. London: Oxford University Press.
- Axelgard, Frederick W. (ed.) (1986a) *Iraq in Transition: A Political, Economic, and Strategic Perspective*. Centre for Strategic and International Studies, Georgetown University, Colorado: Westview Press.
- \_\_\_\_\_, (1986b) "War and Oil," in Frederick W. Axelguard, (ed.), *Iraq in Transition: A Political, Economic, and Strategic Perspective*. Centre for Strategic and International Studies, Georgetown University, Colorado: Westview Press.



- Aykan, Mahmut B. (1996) "Turkey's Policy in Northern Iraq, 1991-95," *Middle Eastern Studies*, Vol. 32, pp. 343-366.
- Ayubi, Nazih N. (1995) *Over-Stating the Arab State: Politics and Society in the Middle East*. London: I.B. Taurus.
- Baaklini, Abdo, Guilain Denoeux, and Robert Springborg (1999) *Legislative Politics in the Arab World: The Resurgence of Democratic Institutions*. Boulder, CO: Lynne Reinner Press.
- Badie, B. (1989) "Comparative Analysis in Political Science: Requiem or Resurrection?" *Political Studies* Vol. 37, No. 3.
- Bakema, W. (1991) "The Ministerial Career," in J. Blondel and J. L. Thiebault, (eds.), *The Profession of Cabinet Ministers in Western Europe*. Basingstoke, Hants.: Macmillan, pp. 70-98.
- Banks, Michael, and Martin Shaw (1991) *State and Society in International Relations*. New York: St. Martin's Press.
- Barkey, Henry J. (1997) "Turkey and the new Middle East: A Geopolitical Exploration," in Henry J. Barkey, (ed.), *Reluctant neighbour : Turkey's Role in the Middle East*. Washington, DC : US Institute of Peace Press. pp. 25-43.
- Barth, F. (1953) *Principles of Social Organization in Southern Kurdistan*.
- Batatu, Hanna. (1978) *The Old Social Classes and the Revolutionary Movements of Iraq: A Study of Iraq's Old Landed and Commercial Classes and of its Communists, Ba'thists, and Free Officers*. NJ: Princeton University Press.
- Beaumont, Peter and Keith McLachlan, (eds.) (1985) *Agricultural Development in the Middle East*. London: John Wiley and Sons.
- Bebler, A., and J. Seroka, (eds.) (1990) *Contemporary Political Systems*. Boulder, CO: Lynne Reinner.
- Bengio, Ofra (1990) "The Iraqi Kurds: The Struggle for Autonomy in the Shadow of the Iran-Iraqi Conflict," *Immigrants & Minorities*, Vol. 9: 249-268.

- \_\_\_\_\_, (1993) "Experimentation in Kurdish Self-Rule," *Middle East Contemporary Survey*, Vol. 17 (1993). Boulder CO: Westview Press (1995, edited by Ami Ayalon).
- \_\_\_\_\_, (1995) "The Challenge to the Territorial Integrity of Iraq," *Survival*, Vol. 37: 74-94.
- \_\_\_\_\_, (1999) "Nation Building in Multuethnic Societies: The Case of Iraq," in Ofra Bengio and Gabriel Ben-Dor (eds.) *Minorities and the State in the Arab World*. Boulder, CO: Lynne Reinner Publishers.
- Bengio, Ofra, and Gabriel Ben-Dor (eds.) (1999) *Minorities and the State in the Arab World*. Boulder, CO: Lynne Reinner Publishers.
- Benjamin, Charles (1977) "The Kurdish Nonstate Nation," in Judy S. Bertelsen, (ed.), *Nonstate Nations in International Politics: Comparative System Analyses*. New York: Praeger Publishers.
- Bertelsen, Judy S., (ed.) (1977) *Nonstate Nations in International Politics: Comparative System Analyses*. New York: Praeger Publishers.
- Besifki, Nawzat (1996) *The Kurdish National Liberation Movement Since 1975: Success or Failure?* PhD thesis, University of Southampton.
- Blondel, Jean (1972) *Comparing Political Systems*. London: Weidenfield and Nicolson.
- \_\_\_\_\_, (1973) *Comparative Legislatures*. Englewood Cliffs, NJ: Prentice Hall.
- \_\_\_\_\_, (1982) *The Organization of Governments*. London: Sage.
- \_\_\_\_\_, (1985) *Government Ministers in the Contemporary World*. London: Sage.
- \_\_\_\_\_, (1987) *Political Leadership*. London: Sage.
- \_\_\_\_\_, (1995) *Comparative Government: An Introduction*. London: Prentice Hall/Harvester Wheatsheaf.
- Blondel, Jean, and F. Muller-Rommel (eds.) (1988) *Cabinets in Western Europe*. London: Macmillan.



- Bozarslan, Hamit (1997) "Kurdistan: Kriegswirtschaft – Wirtschaft im Krieg" in Carsten Borck, Eva Savelsberg and Siamend Hajo (eds.) *Kurdologie, Ethnizitat, Nationalismus, Religion und Politik in Kurdistan*. Lit. S.
- Braidwood, Robert J., and Bruce Howe (1960) *Prehistoric Investigations in Iraqi Kurdistan*. Studies in Ancient Oriental Civilization, No. 31, The Oriental Institute of the University of Chicago. Illinois: University of Chicago Press.
- Bruinessen, Martin Van (1986) "The Kurds Between Iran and Iraq." *MERIP Middle East Report* 16, no. 4 (July - August 1986): 14-27.
- \_\_\_\_\_, (1991) "Kurdish Society and the Modern State: Ethnic Nationalism Versus Nation-Building," in Turaj Atabaki and Margreet Dorleijn, (eds.), *Kurdistan in Search of Ethnic Identity*. Papers presented to the 1<sup>st</sup> Conference on Ethnicity and Ethnic Identity in the Middle East and Central Asia. University of Utrecht: Department of Oriental Studies.
- \_\_\_\_\_, (1992a) *Agha, Shaikh and State: The Social and Political Organization of Kurdistan*. London: Zed Books.
- \_\_\_\_\_, (1992b) "Kurdish Society, Ethnicity, Nationalism and Refugee Problems," in Kreyenbroek, Philip G., and Stefan Sperls, (eds.), 1992, *The Kurds: A Contemporary Overview*. London: Routledge/SOAS.
- \_\_\_\_\_, (1994a) "Genocide in Kurdistan? The Suppression of the Dersim Rebellion in Turkey (1937-38) and the Chemical War Against the Iraqi Kurds (1988)," in George J. Andreopoulos, (ed.), *Conceptual and Historical Dimensions of Genocide*. University of Pennsylvania Press.
- \_\_\_\_\_, (1994b) "Genocide of Kurds," in Ismael W. Charny, (ed.), *The Widening Circle of Genocide*. New York: Transaction Books.
- Bryman, Alan (1992) *Charisma & Leadership in Organizations*. London: Sage Publications.
- Buchanan, A. (1992) "Self-Determination and the Right to Secede", *Journal of International Affairs* Vol 45, No. 2: pp. 347-366.

- Buckley, Richard, (ed.) (1994) *The Kurds: Caught Between Nations*. Understanding Global Issues 94/3, European Schoolbooks Publishing, UK.
- Bulloch, John and Harvey Morris (1992) *No Friends but the Mountains: The Tragic History of the Kurds*. London: Penguin Books.
- Butterfield, Herbert, and Martin Wight, (eds.) (1968) *Diplomatic Investigations: Essays in the Theory of International Politics*. Cambridge, MA: Harvard University Press.
- Buzan, Barry (1991) *People, States and Fear: An Agenda for International Security Studies in the Post-Cold War Era*. London: Harvester Wheatsheaf.
- Calvert Peter (1983) *Politics, Power and Revolution: An Introduction to Comparative Politics*. London: Wheatsheaf Books.
- Camilleri, Joseph A. (1990) "Rethinking Sovereignty in a Shrinking, Fragmented World," in R. B. J. Walker and Saul H. Mendlovitz, (eds.), *Contending Sovereignties: Redefining Political Community*. Boulder, CO: Lynne Reinner Publishers.
- Camilleri, Joseph A., and J. Falk (1992) *The End of Sovereignty: The Politics of a Shrinking and Fragmenting World*. Aldershot: Edward Elgar.
- Catudal, Honore M. (1976) "The War in Kurdistan: End of a Nationalist Struggle?" *International Relations*, Vol. 5.
- Center for Economic and Social Rights (1996) *UN-sanctioned Suffering: A Human Rights Assessment of United Nations Sanctions on Iraq*. New York: Centre for Economic and Social Rights.
- Chaliand, Gerard, (ed.) (1989) *Minority Peoples in the Age of Nation States*, London: Pluto Press.
- \_\_\_\_\_, (ed.) (1993) *A People Without a Country: The Kurds and Kurdistan*. New York: Olive Branch Press.
- \_\_\_\_\_, (1994) *The Kurdish Tragedy*. London: Zed Press.
- Charlot, Jean (1989) "Political Parties: Towards a New Theoretical Synthesis," *Political Studies*, Vol. 37, No. 3.



- Chase, Robert, Emily Hill, and Paul Kennedy (1996) "Pivotal States and U.S. Strategy," *Foreign Affairs*, Vol. 75, No. 11 (January/February), pp. 33-51.
- Chubin, Shahram, and Charles Tripp (1991) *Iran and Iraq at War*. Boulder, Colorado: Westview Press.
- Ciment, James (1996) *The Kurds: State and Minority in Turkey, Iraq and Iran. Conflict and Crisis in the Post-Cold War World*, New York: Facts on File.
- Clapham, Christopher (ed.) (1998) *African Guerrillas*. Oxford: James Curry.
- Clark, Ian (1997) *Globalization and Fragmentation: International Relations in the Twentieth Century*. Oxford: Oxford University Press.
- Cohen, Saul B. (1975) *Geography and Politics in a World Divided*. Oxford: Oxford University Press.
- Collins, R. (1986) "Modern Technology and Geopolitics," in R. Collins, *Weberian Sociological Theory*. New York: Cambridge University Press.
- Conlon, Paul (1995) "Lessons From Iraq: The Functions of the Iraq Sanctions Committee as a Source of Sanctions Implementation Authority and Practice," *Virginia Journal of International Law*, No. 3, pp. 633-668.
- Cook, Helena (1995) *The Safe Haven in Northern Iraq: International Responsibility for Iraqi Kurdistan*. London: Human Rights Centre and University of Essex.
- Crane, Richard (1991) "Regionalism and the Post-Cold War Era," *International Journal*, Vol. 46, No. 3, pp. 373-393.
- Crusoe, Jonathan (1986) "Economic Outlook: Guns and Butter, Phase Two?" in Frederick W. Axelguard, (ed.), *Iraq in Transition: A Political, Economic, and Strategic Perspective*. Centre for Strategic and International Studies, Georgetown University, Colorado: Westview Press.

- Cuny, Frederick C. (1995) *The Political, Military, Economic and Humanitarian Situation in Iraqi Kurdistan: An Assessment*. Carnegie Endowment for International Peace.
- Dahl, R. A. (1971) *Polyarchy*. New Haven, Conn.: Yale University Press.
- Dann, Uriel (1969) *Iraq Under Qassem: A Political Study 1958 - 63*. New York: Praeger Press.
- \_\_\_\_\_, (1978) "The Kurdish National Movement in Iraq." *Jerusalem Quarterly* 9 (Fall 1978): pp. 131 - 144.
- Demko, George J. and William B. Wood, (eds.) (1994a) *Reordering the World: Geopolitical Perspectives on the 21<sup>st</sup> Century*. Boulder, CO: Westview Press.
- Deutsch, K. W. (1963) *The Nerves of Government*. New York: Free Press.
- Dodds, Klaus (2000) *Geopolitics in a Changing World*. London: Prentice Hall.
- Dofny, Jacques, and Akinsole Akiwowo, (eds.) (1980) *National and Ethnic Movements*. Sage Studies in International Sociology 19. London: Sage.
- Dougherty, J. E., and R. L. Pfaltzgraff (1990) *Contending Theories of International Relations*. New York: Harper and Row.
- Dreze, Jean and H. Gazdar (1992) "Hunger and Poverty in Iraq, 1991." *World Development*, Vol. 20, No. 7, pp. 921-945.
- Duchacek, I. (1973) *Power Maps: The Comparative Politics of Constitutions*. Santa Barbara, Calif.: ABC Clio.
- Dunleavy, P., and B. O'Leary (1987) *Theories of the State*. Basingstoke: Macmillan.
- Durham University Policy Planning Unit (1997) *Inception Report*, Unpublished report for Department for International Development, London.
- \_\_\_\_\_, (1998) *The Socio-Economic Situation and the Humanitarian Aid Programme in Iraqi Kurdistan*. Unpublished report for Department for International Development, London.
- Duverger, M. (1954) *Political Parties*. New York: Wiley.



- Dziegel, L. (1981) *Rural Community of Contemporary Iraqi Kurdistan Facing Modernization*. Krakow.
- Eagleton, W. J. (1963) *The Kurdish Republic of 1946*. London: Oxford University Press.
- Easton, D. (1953) *The Political System*. New York: Knopf Press.
- \_\_\_\_\_, (1965a) *A Systems Analysis of Political Life*. New York: Wiley.
- \_\_\_\_\_, (1965b) *A Framework for Political Analysis*. Eaglewood Cliffs, NJ: Prentice-Hall.
- \_\_\_\_\_, (1981) "The Political System Besieged by the State," *Political Theory*, Vol. 9, No. 3, pp. 303-326.
- Edmonds, C. J. (1957) *Kurds, Turks and Arabs: Politics, Travel and Research in North-Eastern Iraq, 1919-1925*. London: Oxford University Press.
- Eldersveld, Samuel J. (1964) *Political Parties: A Behavioural Analysis*. New York: Rand McNally.
- Emadi, Hafizullah (1992) "Conflict in the Middle East: The Kurdish National Question," *Contemporary Review*, Vol. 261: 62-71.
- Entessar, Nader (1984a) "Changing Patterns of Iranian - Arab Relations." *Journal of Social, Political and Economic Studies* Vol. 9, No. 3 (Fall 1984): pp. 341-358.
- \_\_\_\_\_, (1984b) "The Kurds in Post-Revolutionary Iran and Iraq." *Third World Quarterly* Vol. 6, No. 4 (October 1984): pp. 911-933.
- \_\_\_\_\_, (1989) "The Kurdish Mosaic of Discord." *Third World Quarterly* Vol. 11, No. 4 (October 1989): pp. 83-100.
- \_\_\_\_\_, (1991) "Kurdish Identity in the Middle East." *Current World Leaders* Vol. 34, No. 2 (April 1991): pp. 270-282.
- \_\_\_\_\_, (1992) *Kurdish Ethnonationalism*. Boulder, Colorado: Lynne Rienner Publishers.
- Esman, Milton J. (1995) "Ethnic Actors in International Politics," *Nationalism and Ethnic Politics*, Vol. 1, No. 1 (Spring), pp. 111-125.

- Esman, Milton J., and Itamar Rabinovich, (eds.) (1988) *Ethnicity, Pluralism, and the State in the Middle East*. New York: Cornell University Press, Ithaca.
- Europa (1990) *Middle East and North Africa*.
- Falk, Richard (1991) "The Cruelty of Geopolitics: The Fate of Nation and State in the Middle East," *Millennium Journal of International Studies*, Vol. 20, No. 3: 383-393.
- Farouk-Sluglett, Marion, and Peter Sluglett (1990) *Iraq Since 1958: From Revolution to Dictatorship*. London: I.B. Taurus.
- Feili, Omar Yahya, and Arlene R. Fromchuck (1976) "The Kurdish Struggle for Independence." *Middle East Review* 9, no. 1 (Fall 1976): pp. 47-59.
- Ferguson, Yale H., and Richard W. Mansbach (1988) *The Elusive Quest: Theory and International Politics*. Columbia: University of South Carolina Press.
- Field, John (1993) "From Food Security to Food Insecurity: The Case of Iraq, 1990-1991." *Geojournal* Vol. 30, No. 2, (June); pp. 185-194.
- Foster, C. R., (ed.) (1980) *Nations Without a State*. New York: Praeger.
- Frankland, E. (1995) "A New Nationalism for a New World Order? The Kurds," *Small Wars and Insurgencies*, Vol. 6: 183-208.
- Freedman, Lawrence (1993) "The War and the New World Order," in James Gow (ed.) *Iraq, the Gulf Conflict and the World Community*. London: Brassey's; pp. 183-200.
- Freedman, Lawrence, and David Boren (1992) "Safe Havens for Kurds in Post-War Iraq," in Rodley, Nigel (ed.) *To Loose the Bands of Wickedness*. London: Brassey's / David Davies Memorial Institute of International Studies: 43-92.
- Freedman, Lawrence, and Efraim Karsh (1993) *The Gulf Conflict 1990-1991*. Princeton: Princeton University Press.
- Freij, Hanna Y. (1997) "Tribal Identity and Alliance Behaviour Among Factions of the Kurdish National Movement in Iraq," *Nationalism and Ethnic Politics*, Vol. 3, pp. 86-110.



- Frisch, Hillel (1998) *Countdown to Statehood: Palestinian State Formation in the West Bank and Gaza*. Albany, NY: State University of New York Press.
- Gavan, S. S. (1958) *Kurdistan: Divided Nation of the Middle East*. London: Lawrence & Wishart.
- Gazdar, Haris (1997) *The Economy Under Sanctions*. International Conference in Collaboration with the Iraqi Economic Forum on; Frustrated Development: The Iraqi Economy in War and Peace, Centre for Arab Gulf Studies, University of Exeter, 9-11 July 1997.
- Geertz, Clifford (1995) *After the Fact: Two Countries, Four Decades, One Anthropologist*. Cambridge, MA: Harvard University Press.
- Ghafour, S. M. (1997) *The Longest Revolution: The Kurdish Chrono-Political History*. London: Avon Books.
- Ghareeb, Edmund (1981) *The Kurdish Question in Iraq*. Syracuse University Press, New York.
- Ghassemlou, Abdul Rahman (1965) *Kurdistan and the Kurds*. Publishing House of the Czechoslovak Academy of Sciences, Prague / Collet's Publishers, London.
- Glassner, Martin Ira (1996) *Political Geography*. New York: John Wiley & Sons.
- Gottlieb, Gidon (1993) *Nation Against State: A New Approach to Ethnic Conflicts and the Decline of Sovereignty*. New York: Council on Foreign Relations Press.
- \_\_\_\_\_, (1994) "Nations without States." *Foreign Affairs*, Vol. 73 No. 3, May-June, pp. 100-112.
- Gow, James (ed.) (1993) *Iraq, the Gulf Conflict and the World Community*. London: Brassey's – Centre for Defence Studies.
- Graham-Brown, Sarah (1999) *Sanctioning Saddam: The Politics of Intervention in Iraq*. London: I.B. Taurus.

- Graham-Brown, Sarah, and Zina Sackur (1995) "The Middle East: The Kurds – A Regional Issue." December 1995, WRITENET Country Papers, UNHCR, Switzerland.
- Gray, Colin S., and Geoffrey Sloan (eds.) (1999) *Geopolitics: Geography and Strategy*. London: Frank Cass.
- Gross, Feliks (1998) *The Civic and the Tribal State: The State, Ethnicity, and the Multiethnic State*. New York: Greenwood Press.
- Guevara, Ernesto (Che) (1985) *Guerrilla Warfare*. University of Nebraska Press.
- Gunter, Michael M. (1990) *The Kurds in Turkey: A Political Dilemma*. Westview Special Studies on the Middle East.
- \_\_\_\_\_, (1993a) *The Kurds of Iraq: Tragedy and Hope*. New York: St. Martin's Press.
- \_\_\_\_\_, (1993b) "A *de facto* Kurdish State in Northern Iraq," *Orient*, Vol. 34: 379-401.
- \_\_\_\_\_, (1993c) "Foreign Influences on the Kurdish Insurgency in Iraq," *Orient*, Vol. 34: 105-119.
- \_\_\_\_\_, (1996a) "The KDP - PUK Conflict in Northern Iraq." *Middle East Journal* 50, no. 2 (Spring 1996): 225-241.
- \_\_\_\_\_, (1996b) "Kurdish Infighting: The PKK – KDP Conflict," in Robert Olson, (ed.), *The Kurdish Nationalist Movement in the 1990s: Its Impact on Turkey and the Middle East*. Lexington: The University Press of Kentucky.
- \_\_\_\_\_, (1999a) "Developments in Iraqi Kurdistan: Their Influence on Neighbouring States and the Kurdish Movements in Surrounding States" in *Irakisch-Kurdistan: Status und Perspektiven. Ergebnisse einer internationalen tagung 1999 in Berlin*, pp. 65-80. Berlin: Awadani e.V.
- \_\_\_\_\_, (1999b) *The Kurdish Predicament in Iraq: A Political Analysis*. New York: St Martin's Press.



- Gurr, Ted Robert (ed.) (1980) *Handbook of Political Conflict*. New York: Free Press.
- \_\_\_\_\_, (1993) *Minorities at Risk: A Global View of Ethnopolitical Conflicts*. Washington D.C.: U.S. Institute of Peace.
- \_\_\_\_\_, (1994) "Peoples Against the States: Ethno-political Conflict and the Changing World System," *International Studies Quarterly*, Vol. 38, pp. 347-377.
- Gurr, Ted Robert, and Barbara Harff (1994) *Ethnic Conflict in World Politics*. Boulder, CO: Westview Press.
- Hafeed, S. (1993) "The Embargo on Kurdistan: Its Influence on the Economic and Social Development," in Fuad Hussein, and Michiel Leezenberg, (eds.) *The Reconstruction and Economic Development of Iraqi Kurdistan: Challenges and Perspectives*. Amsterdam: Netherlands Kurdistan Society.
- Hague, R., M. Harrop, and S. Breslin (1998) *Comparative Government and Politics: An Introduction*. Basingstoke, Hants: Macmillan.
- Hannum, Hurst (1990) *Autonomy, Sovereignty, and Self-Determination: The Accommodation of Conflicting Rights*. Philadelphia, PA: University of Pennsylvania Press.
- Harff, Barbara (1993) "Minorities, Rebellion and Repression in North Africa and the Middle East," in Ted Robert Gurr, (ed.), *Minorities at Risk: A Global View of Ethnopolitical Conflicts*. Washington D.C.: U.S. Institute of Peace; pp. 217-251.
- Hariri, Franso (1996) *Liqay la Yuqtab al-Tarirkhu Muharafen* (In Order not to Write False History). Dohuk: Khabat Publishers.
- Harris, George S. (1977a) "Ethnic Conflict and the Kurds." *The Annals of the American Academy of Political and Social Science*, 433 (September 1977): 112 - 124.
- \_\_\_\_\_, (1977b) "The Kurdish Conflict in Iraq," in Astri Suhrke and Lela Garner Noble, (eds.), *Ethnic Conflict in International Relations*. New York: Praeger Publications.

- Hashmi, Sohail H., (ed.) (1997a) *State Sovereignty: Change and Persistence in International Relations*. Pennsylvania: Pennsylvania State University Press.
- \_\_\_\_\_, (1997b) "Introduction," in Sohail Hashmi, (ed.), *State Sovereignty: Change and Persistence in International Relations*. Pennsylvania: Pennsylvania State University Press.
- Hassanpour, Amir (1992) *Nationalism and Language in Kurdistan, 1918-85*. Mellen University Research Press, San Francisco.
- Hay, C. (1995) "Structure and Agency," in D. Marsh and G. Stoker, (eds.), *Theory and Method in Political Science*. New York: St. Martin's Press.
- Hazen, William E. (1979) "Minorities in Revolt: The Kurds of Iran, Iraq, Syria, and Turkey," in R. D. McLaurin (ed.) *The Political Role of Minority Groups in the Middle East*. New York: Praeger Publishers: pp. 49-75.
- Hazleton, Fran (ed.) (1994) *Iraq Since the Gulf War: Prospects for Democracy*. The Committee Against Repression and for Democratic Rights in Iraq (CARDRI). London: Zed Books.
- Hejar (1997) *Tchehti Mijewir (Autobiographie)*. Edited by Khani Sharafkandi. Paris.
- Heraclides, Alexis (1990) "Secessionist Minorities and External Involvement," *International Organization*, Vol. 44, No. 3 (Summer), pp. 341-378.
- \_\_\_\_\_, (1991) *The Self-Determination of Minorities in International Politics*, London: Frank Cass.
- \_\_\_\_\_, (1992) "Secession, Self-Determination and Non-Intervention", *Journal of International Affairs*, Vol. 45, No. 2: pp. 399-420.
- Hoff, Ruud, Michiel Leezenberg, and Pieter Miller (1992) *Elections in Iraqi Kurdistan: An Experiment in Democracy*. Brussels: Pax Christi International.
- Hoffman, George W. (1988) "Political Geography and International Relations," in Harm de Blij, (ed.), *Earth '88: Changing Geographic Perspective*. Washington, D.C.: National Geographic Society.
- Holton, Robert J. (1998) *Globalization and the Nation-State*. Basingstoke: Macmillan.



- Human Rights Watch/Middle East (1990) *Human Rights in Iraq*. New Haven, CT: Yale University Press.
- \_\_\_\_\_, (1992) *Endless Torment: The 1991 Uprising in Iraq and its Aftermath*. New York: Human Rights Watch.
- \_\_\_\_\_, (1993a) *Genocide in Iraq: The Anfal Campaign Against the Kurds*. New York: Human Rights Watch.
- \_\_\_\_\_, (1993b) *The Anfal Campaign in Iraqi Kurdistan: The Destruction of Koreme*. New York: Human Rights Watch.
- \_\_\_\_\_, (1994) *Bureaucracy of Repression: The Iraqi Government in its Own Words*. New York: Human Rights Watch.
- Huntingdon, Samuel P. (1968) *Political Order in Changing Societies*. New Haven, Conn.: Yale University Press.
- \_\_\_\_\_, (1991) *The Third Wave: Democratization in the Late Twentieth Century*. Norman and London: University of Oklahoma Press.
- Hussain, H. M. (1990) "Iraq's Agricultural Land Use Program," in A. Salman (ed.), *Agriculture in the Middle East*. New York: Paragon.
- Hyman, Anthony (1988) "Elusive Kurdistan: The Struggle for Recognition." *Conflict Studies* 214, Centre for Security and Conflict Studies (The Institute for the Study of Conflict): pp. 1-25.
- Iraqi Kurdistan National Assembly (1997) *Iraqi Kurdistan National Assembly: The Proceedings*. Volumes 1-16. Kurdistan National Assembly: Erbil.
- Izady, Mehrdad R. (1988a) "A Kurdish Lingua Franca?" *Kurdish Times*, Vol. 2, No. 2 (Summer 1988), pp. 13 - 24.
- \_\_\_\_\_, (1988b) "Kurdistan," *The Encyclopaedia of Asian History*. New York: The Asiatic Society.
- \_\_\_\_\_, (1992) *The Kurds: A Concise Handbook*. Washington DC: Crane Russak.
- Jackson, R. (1990) *Quasi-States: Sovereignty, International Relations and the Third World*. Cambridge: Cambridge University Press.

- Jackson, P. H., and C. G. Rosberg (1982) *Personal Rule in Black Africa*. Berkeley, Calif.: University of California Press.
- Janda, Kenneth (1970) *A Conceptual Framework for the Comparative Analysis of Political Parties*. London: Sage.
- Janda, Kenneth, and Robin Gillies (1983) "How Well Does 'Region' Explain Political Party Characteristics?" *Political Geography Quarterly*, Vol. 2, No. 3, pp. 179-203.
- Jawad, Sa'ad N. (1979) "The Kurdish Problem in Iraq," in Kelidar, A. (ed.) *The Integration of Modern Iraq*. London: Croom Helm.
- \_\_\_\_\_, (1981) *Iraq and the Kurdish Question 1958 - 1970*. London: Ithaca Press.
- \_\_\_\_\_, (1982) "Recent Developments in the Kurdish Issue." in Tim C. Niblock (ed.) *Iraq: The Contemporary State*. London: Croom Helm.
- Jayran-Nejad, Yadi (1992) "A Summary of Kurdish Autonomy Proposals and the Major Barriers to their Implementation," in Maria T. O'Shea, (ed.), *Kurdistan: Political and Economic Potential*. London: SOAS.
- Johnstone, Ian (1994) *Aftermath of the Gulf War: An Assessment of UN Action*. International Peace Academy, Occasional Paper Series; Boulder, Colorado: Lynne Rienner Publishers.
- Jwaideh, Wadie (1960) *The Kurdish Nationalist Movement: Its Origins and Development*. Unpublished PhD, Syracuse University.
- Kaiser, André (1997) "Types of Democracy: From Classical to New Institutionalism," *Journal of Theoretical Politics*, Vol. 9, No. 4, pp. 419-444.
- Kakai, Falak al-Din (1992) "The Kurdish Parliament," in Fran Hazleton, (ed.), *Iraq Since the Gulf War: Prospects for Democracy*. CARDRI, London: Zed Books.
- Karadaghi, Kamran (1993) "The Two Gulf Wars: The Kurds on the World Stage, 1979-1992," in Gerard Chaliand (ed.) *A People Without a Country: The Kurds and Kurdistan*. New York: Olive Brach Press.



- Kashi, Ed, and Christopher Hitchens (1994) *When the Borders Bleed: The Struggle of the Kurds*. London: Chatto & Windus.
- Kashyap, S. (1979) "Committees in the Indian Lok Sabha," in J. Lees and M. Shaw (eds.) *Committees in Legislatures: A Comparative Perspective*. Durham, NC: Duke University Press.
- Keen, David (1993) *The Kurds in Iraq - How Safe is their Haven Now?* London: Save the Children Fund - UK.
- \_\_\_\_\_, (1995) "Short Term Interventions and Long Term Problems: The Case of the Kurds in Iraq," in John Harriss (ed.); *The Politics of Humanitarian Intervention*, pp. 167-184. London: Pinter.
- Kelidar, Abbas (1975) *Iraq: The Search for Stability*. Conflict Studies 59, July 1975, Institute for the Study of Conflict. London: Eastern Press.
- \_\_\_\_\_, (1979) *The Integration of Modern Iraq*, London: Croom Helm.
- Khadduri, Majid (1951) *Independent Iraq*, London: Oxford University Press.
- \_\_\_\_\_, (1969) *Republican Iraq: A Study in Iraqi Politics Since the Revolution of 1958*. London: Oxford University Press.
- \_\_\_\_\_, (1978) *Socialist Iraq: A Study in Iraqi Politics Since 1968*. Washington D.C.: Middle East Institute.
- \_\_\_\_\_, (1988) *The Gulf War: The Origins and Implications of the Iraq-Iran Conflict*. New York: Oxford University Press.
- Khan, Faisal (1988) "Ethnopolitics: The Kurdish Factor in the Iraq-Iran War," *Middle East Focus*, Vol. 10: 22-26.
- Khashan, Halil (1995) "The Labyrinth of Kurdish Self-Determination," *International Journal of Kurdish Studies*, Vol. 8, Nos. 1-2: 5-32.
- Khoury, Philip S., and Joseph Kostiner (eds.) (1990) *Tribes and State Formation in the Middle East*. Berkeley: University of California Press.
- Kinnane, Derk (1964) *The Kurds and Kurdistan*. London: Oxford University Press.
- Kinsman, James (1970) "Kurds and Iran: Iraq's Changing Balance of Power," *New Middle East*, Vol. 22.

- Kirisci, Kemal (1996) "Turkey and the Kurdish Safe Haven in Northern Iraq," *Journal of South Asian and Middle Eastern Studies*, Vol. 19, pp. 21-39.
- Kirisci, Kemal, and Gareth M. Winrow (1997) *The Kurdish Question and Turkey: An Example of a Trans-State Ethnic Conflict*. Frank Cass & Co., London.
- Kliot, Nurit (1994) *Water Resources and Conflict in the Middle East*. London: Routledge.
- Kliot, Nurit, and Stanley Waterman (eds.) (1983) *Pluralism and Political Geography: People Territory and State*. London: Croom Helm.
- Knight, David B. (1983) "The Dilemma of Nations in a Rigid State Structured World," in Nurit Kliot and Stanley Waterman, (eds.), *Pluralism and Political Geography: People Territory and State*. London: Croom Helm.
- \_\_\_\_\_, (1992) "Statehood: A Politico-Geographic and Legal Perspective," *GeoJournal*, Vol. 28, No. 3, pp. 311-318.
- \_\_\_\_\_, (1994) "People Together, Yet Apart: Rethinking Territory, Sovereignty, and Identities," in George J. Demko and William B. Wood (eds.) *Reordering the World: Geopolitical Perspectives on the 21<sup>st</sup> Century*. Boulder, CO: Westview Press.
- Kofman, Eleonore and Gillian Youngs (eds.) (1996) *Globalization: Theory and Practice*. London: Pinter.
- Kohli, Atul (1995) "Conclusion" in "The Role of Theory in Comparative Politics: A Symposium," *World Politics*, Vol. 48, No.1, pp. 1-49.
- Krader, Lawrence (1968) *Formation of the State*. Englewood Cliffs, NJ: Prentice Hall.
- Krasner, S. D. (1984) "Approaches to the State: Alternative Conceptions and Historical Dynamics," *Comparative Politics*, Vol. 16, No. 2, (Jan), pp. 223-246.
- \_\_\_\_\_, (1999) *Sovereignty: Organized Hypocrisy*. Princeton, NJ: Princeton University Press.



- Kreyenbroek, Philip G. (1992a) "The Kurdish Language: Symbol or Reality?" in Maria T. O'Shea (ed.) *Kurdistan: Political and Economic Potential*. London: SOAS.
- \_\_\_\_\_, (1992b), "On the Kurdish Language," in Kreyenbroek, P. G., and Stefan Sperl, (eds.) *The Kurds: A Contemporary Overview*. London: Routledge.
- Kreyenbroek, Philip G. and Stefan Sperl (eds.) (1992) *The Kurds: A Contemporary Overview*. London: Routledge.
- Kriek, D. J. (1995) "David Easton and the Analysis of Political Structure," *Journal of Theoretical Politics*, Vol. 8.
- Kurdistan Democratic Party (1993a) *Kurdistan Democratic Party (KDP) Congresses 1946-1993*. Erbil: Kurdistan News Press.
- \_\_\_\_\_, (1993b) *Internal Programme of the Eleventh Congress of the Kurdistan Democratic Party*. Erbil.
- \_\_\_\_\_, (1994) *What Happened in Iraqi Kurdistan, May-1994?* Salahadin, Erbil: KDP Research Department.
- \_\_\_\_\_, (1999) *Kurdistan: An Economic, Geographic and Historical Brief Explanation*. KDP Politbureau Central Bureau for Studies and Research, Study No. 33.
- Kurdistan National Assembly (1994) *Ademocrattiyya Aparliamen wa Hukumat fi Junub Kurdistan*, (Parliamentary Democracy and Governance in Southern Kurdistan): Erbil, Iraqi Kurdistan.
- \_\_\_\_\_, (1995) *Demokrasi Parliament u Hukumeta Basura Kurdistan*. (Parliamentary Democracy and Governance in Southern Kurdistan) South Kurdistan: SILC.
- Kutschera, Chris (1979) *Le Mouvement National Kurde*, Paris: Flammarion.
- Laitin, D. D., and Said S. Samatar (1987) *Somalia: Nation in Search of a State*. Boulder, CO: Westview Press.

- Lane, Ruth (1994) "Structural-Functionalism Reconsidered: A Proposed Research Model," *Comparative Politics*, vol. 26, no. 4, pp. 461-478.
- LaPalombara, J., and M. Weiner (1966) *Political Parties and Political Development*. Princeton: Princeton University Press.
- Laquer, Walter (1961) *Communism and Nationalism in the Middle East*, London.
- Lasswell, H. D., and A. Kaplan (1950) *Power and Society: A Framework for Political Enquiry*. Yale: Yale University Press.
- Lawrence, David Aquila (2000) "Iraqi Kurds Enjoy a De Facto State," in *The Christian Science Monitor*, 3 May 2000.
- Lawson, Kay (1976) *The Comparative Study of Political Parties*. New York: St. Martin's Press.
- \_\_\_\_\_, (1980) *Political Parties and Linkage: A Comparative Perspective*. New Haven, Conn.: Yale University Press.
- \_\_\_\_\_, (ed.) (1994) *How Political Parties Work: Perspectives from Within*. London: Praeger.
- Lazier, Sheri (1991) *Into Kurdistan: Frontiers Under Fire*, London: Zed Books.
- \_\_\_\_\_, (1996) *Martyrs, Traitors and Patriots: Kurdistan After the Gulf War*, London: Zed Books.
- Leach, E. R. (1940) *Social and Economic Organisation of the Rowanduz Kurds*, Monographs on Social Anthropology No. 3, London School of Economics and Political Science. London: Percy Lund, Humphries & Co.
- Lees, J. and M. Shaw (eds.) *Committees in Legislatures: A Comparative Perspective*. Durham, NC: Duke University Press.
- Leezenberg, Michiel (1999a) *Refugee Camp or Free Trade Zone? The Economy of Iraqi Kurdistan Since 1991*. Unpublished paper, University of Amsterdam, Netherlands.
- \_\_\_\_\_, (1999b) "Violence and Modernity: The Baath's Ambiguous Heritage in Iraqi Kurdistan," in *Irakisch-Kurdistan: Status und Perspektiven*.



*Ergebnisse einer internationalen tagung 1999 in Berlin*, pp. 159-167.  
Berlin: Awadani.e.V.

Lijphart, Arend (1969) "Consociational Democracy," *World Politics*, Vol. 21 (January).

\_\_\_\_\_, (1977) *Democracy in Plural Societies*. New Haven, Conn.: Yale University Press.

\_\_\_\_\_, (1996) "The Puzzle of Indian Democracy: A Consociational Interpretation," *American Political Science Review*, Vol. 90, (June).

Linz, Juan J. (1990) "Transitions to Democracy." *Washington Quarterly*, Vol. 13, No. 3 (Summer), pp. 143-164.

Lipset, Seymour M. (1964) "Political Cleavages in Developed and Emerging Polities," in Erik Allardt, and Yrjo Littunen, (eds.), *Cleavages, Ideologies and Party Systems: Contributions to Comparative Political Sociology*. Helsinki: The Academic Bookstore;

Lonsdale, David J. (1999) "Information Power: Strategy, Geopolitics, and the Fifth Dimension," in Colin S. Gray and Geoffrey Sloan, (eds.), *Geopolitics: Geography and Strategy*. London: Frank Cass.

Lustick, Ian S. (1997) "Lijphart, Lakatos and Consociationalism," *World Politics*, Vol. 50, (October), pp. 88-117.

MacDonald, Charles G. (1983) "The Impact of the Gulf War on the Iraqi and Iranian Kurds," *Middle East Contemporary Survey*, Vol. 7.

\_\_\_\_\_, (1988) "The Kurdish Question in the 1980s," in Milton J. Esman and Itamar Rabinovich, (eds.), *Ethnicity, Pluralism and the State in the Middle East*. Ithaca, NY: Cornell University Press.

\_\_\_\_\_, (1990) "The Kurds in the 1990s," *Middle East Insight*, Vol. 7: 29-35.

\_\_\_\_\_, (1991) "The Kurds," *Journal of Political Science* 19: 121-139.

\_\_\_\_\_, (1993) "The Kurds," in Bernard Schechterman and Martin Slann, (eds.), *The Ethnic Dimension in International Relations*. Westport, Conn.: Praeger Publishers.

- Mackinder, Halford J. (1904) "The Geographical Pivot of History," *The Geographical Journal*, Vol. 23, pp. 421-437.
- Makiya, Kanan (1989) *The Republic of Fear: Saddam's Iraq*. University of California Press, Hutchinson.
- \_\_\_\_\_, (1993) *Cruelty and Silence: War, Tyranny, Uprising and the Arab World*. Harmondsworth: Penguin Books.
- Mann, Michael (1984) "The Autonomous Power of the State," *European Journal of Sociology*, Vol. 25, pp. 185-213.
- \_\_\_\_\_, (1997) "Has Globalization Ended the Rise and Rise of the Nation State?" *Review of International Political Economy*, Vol. 4.
- Mansbach, Richard W., Yale H. Ferguson, Donald E. Lampert (1976) *The Web of World Politics: Non-State Actors in the Global System*. Englewood Cliffs, NJ: Prentice-Hall.
- Mao Tse-Tung (1954a) *Selected Works*, Vol. II. New York: International Publishers.
- \_\_\_\_\_, (1954b) "On Protracted War," in Mao Tse-Tung, *Selected Works*, Vol. II. New York: International Publishers.
- March, J. G., and J. P. Olsen (1984) "The New Institutionalism," *American Political Science Review*.
- \_\_\_\_\_, (1989) *Rediscovering Institutions*. New York: Free Press.
- Marr, Phebe (1985) *The Modern History of Iraq*. Boulder CO: Westview Press.
- \_\_\_\_\_, (1996) "Turkey and Iraq," in Henry J. Barkey, (ed.), *Reluctant Neighbour: Turkey's Role in the Middle East*. Washington DC: US Institute of Peace Press, pp. 45-69.
- Maybury-Lewis, David (1997) *Indigenous Peoples, Ethnic Groups, and the State*. Boston: Allyn & Bacon.
- McColl, Robert W. (1969) "The Insurgent State: Territorial Bases of Revolution." *Annals of the Association of American Geographers*, Vol. 39, No. 4, pp. 613-631.
- McDowall, David (1989) *The Kurds*. London: Minority Rights Group.



- \_\_\_\_\_, (1991) "The Kurds: An Historical Perspective," *Asian Affairs*, Vol. 22, No. 3: 293-302.
- \_\_\_\_\_, (1992) *The Kurds: A Nation Denied*. London: Minority Rights Group.
- \_\_\_\_\_, (1996) *A Modern History of the Kurds*. London: I. B. Taurus.
- McKenzie, D. N. (1961) "The Origins of Kurdish." *Transactions of the Philological Society*: 68 - 86.
- McLaurin, R. D. (ed.) (1979) *The Political Role of Minority Groups in the Middle East*. New York: Praeger Publishers.
- Meadowcroft, M. and Lunn, M. (1992) "Kurdistan: Elections for Iraqi Kurdish National Assembly and Leader of the Kurdistan Liberation Movement, Monitoring Report." *Electoral Reform Society*, London.
- Meho, Lokman I. (1997) *Kurds & Kurdistan: A Selective & Annotated Bibliography*. London: Greenwood Press.
- Meiselas, Susan (1997) *Kurdistan: In the Shadow of History*. New York: Random House Press.
- Meiselas, Susan and Andrew Whitley (1994) "The Remains of Anfal." *MERIP Middle East Report* 189, no. 24 (July - August 1994): 8-11.
- Menichini, D. (1996) *Evaluation Report on Humanitarian Operations in Northern Iraq*. Report prepared on the request of the European Community Humanitarian Office (ECHO), January 1996.
- Michels, R. (1968) *Political Parties*. New York: Free Press.
- Mikesell, M. W., and A. B. Murphy (1991) "A Framework for Comparative Study of Minority-Group Aspirations," *Annals of the Association of American Geographers*, Vol. 81, pp. 581-604.
- Miller, Norman, and Roderick Aya (1971) *National Liberation: Revolution in the Third World*. London: Collier/Macmillan.
- Ministry of Culture (Erbil) (1998) *Erbil*. Erbil: General Directorate of Antiquities.

- Ministry of Humanitarian Affairs and Cooperation (Suleimaniyah) (1998) *Report on the UN SCR 986-1153 Program: Iraqi Kurdistan*. Suleimaniyah: Kurdistan Regional Government.
- More, Christiane (1984) *Les Kurdes Aujourd'hui: Mouvement National et Partis Politiques*. Paris: Editions L'Harmattan.
- Morris, Harvey (1999) "Inter-Kurdish Conflict in Iraq – Reasons and Effects" in *Irakisch-Kurdistan: Status und Perspektiven. Ergebnisse einer internationalen tagung 1999 in Berlin*, pp. 43-52. Berlin: Awadani e.V.
- Nagel, Joane, and Brad Whorton (1992) "Ethnic Conflict and the World System: International Competition in Iraq (1961-1991) and Angola (1974-1991)," *Journal of Political and Military Sociology*, Vol. 20: 1-35.
- Najem, Tom (1998) *The Collapse and Reconstruction of Lebanon*. Durham: Centre for Middle Eastern and Islamic Studies Middle East Papers, no. 59.
- Nash, Theodore R. (1976) "The Effect of International Oil Interests Upon the Fate of an Autonomous Kurdish Territory: A Perspective on the Conference at Sevres, August 20, 1920." *International Problems (Tel Aviv)*, Vol. 15, Nos. 1-2, pp. 119-133.
- Natali, Denise (1999) *International Aid, Regional Politics and the Kurdish Issue in Iraq After the Gulf War*. Emirates Center for Strategic Studies and Research.
- Needham, Rodney (1981) *Circumstantial Deliveries*. Berkeley: University of California Press.
- Nehme, Michel G., and Hilal Khashan (1995) "Institutionalization and the Enigma of Kurdish Statelessness," *Ethnic Forum*, Vol. 15: 131-152.
- Neumann, S. (1955) *Modern Political Parties*. Chicago, Illinois: Chicago University Press.
- Niblock, Tim C. (ed.) (1980) *Social and Economic Development in the Arab Gulf*. London: Croom Helm.
- \_\_\_\_\_, (ed.) (1982) *Iraq: The Contemporary State*. London: Croom Helm.



- Nietschmann, B. (1994) "The Fourth World: Nations Versus States," in George J. Demko and William B. Wood, (eds.), *Reordering the World: Geopolitical Perspectives on the 21<sup>st</sup> Century*. Boulder, CO: Westview Press.
- Nikitine, Basile (1956) *Les Kurdes, Etude Sociologique et Historique*. Paris: Imprimerie Nationale.
- Nuri, Sheikh Jamal Sheikh (1998), *My Memories in the Komala Organization, 1971-1983*. Suleimaniyah (translated by Kamaran Othman Ali).
- O'Ballance, Edgar (1973) *The Kurdish Revolt: 1961 - 1970*. Faber & Faber, London.
- \_\_\_\_\_, (1996) *The Kurdish Struggle, 1920 - 1994*, London: Macmillan Press.
- Ockerman, H. W., and S. G. Samano (1985) "The Agricultural Development of Iraq," in Peter Beaumont and Keith McLachlan (eds.), *Agricultural Development in the Middle East*. London: John Wiley and Sons.
- Ofteringer, Ronald and Ralf Backer (1994) "A Republic of Statelessness: Three Years of Humanitarian Intervention in Iraqi Kurdistan." *Middle East Report* 24, nos. 2 - 3 (March - June 1994): 40-45.
- Olson, Robert (1991) "Five Stages of Kurdish Nationalism: 1880-1980," *Journal of the Institute of Muslim Minority Affairs*. (July). pp. 391-409.
- \_\_\_\_\_, (1992a) "The Creation of a Kurdish State in the 1990s?" *Journal of South Asian and Middle Eastern Studies*, Vol. XV, No. 4: 1 - 25.
- \_\_\_\_\_, (1992b) "The Kurdish Question in the Aftermath of the Gulf War: Geopolitical and Geostrategic Changes in the Middle East," *Third World Quarterly*, Vol. 13, No. 3: 475-499
- \_\_\_\_\_, (1994a) "The Kurdish Question and Geopolitical and Geostrategic Changes in the Middle East after the Gulf War." *Journal of South Asian and Middle East Studies* 17 (4): pp. 44-6
- \_\_\_\_\_, (1994b) "The Kurdish Question and the Kurdish Problem: Some Geopolitic and Geostrategic Comparisons," *Peuples Mediterraneens*, Nos. 68-69: 77-94.

- \_\_\_\_\_, (ed) (1996a) *The Kurdish Nationalist Movement in the 1990s: Its Impact on Turkey and the Middle East*. Lexington: The University Press of Kentucky.
- O'Neill, Bard E., William R. Heaton and Donald J. Alberts (eds.) (1980) *Insurgency in the Modern World*. Boulder, CO: Westview Press.
- O'Shea, Maria T. (ed.) (1992) *Kurdistan: Political and Economic Potential*. GRC Occasional Paper Series No. 2, Geopolitics and International Boundaries Research Centre, SOAS, London.
- \_\_\_\_\_, (1998) *Myths, Maps and Reality: Geography and Perceptions of Kurdistan*. PhD, School of Oriental and African Studies, University of London.
- O'Sullivan, Patrick (1983) "A Geographical Analysis of Guerrilla Warfare," *Political Geography Quarterly*, Vol. 2, No. 2, pp. 139-150.
- Ó Tauthail, Gearóid (1996) *Critical Geopolitics: The Politics of Writing Global Space*. Minneapolis: University of Minnesota Press.
- Ó Tauthail, Gearóid and Simon Dalby (eds.) (1998) *Rethinking Geopolitics*. London: Routledge.
- Parker, Geoffrey (1985) *Western Geopolitical Thought in the Twentieth Century*. London: Croom Helm.
- Patriotic Union of Kurdistan (PUK) (1977) *Revolution in Kurdistan: The Essential Documents of the Patriotic Union of Kurdistan*. New York: PUK Publications.
- \_\_\_\_\_, (1993) *Internal Programme and Method of the PUK*. Erbil.
- \_\_\_\_\_, (1995) *Iraqi Kurdistan: A Situation Report on Recent Events; The Context and Specifics of the Infighting in Iraqi Kurdistan*. London: PUK Foreign Relations Committee.
- Pelletiere, Stephen C. (1984) *The Kurds: An Unstable Element in the Gulf*. Boulder, CO: Westview Press.



- \_\_\_\_\_, (1991) *The Kurds and their Agas: An Assessment of the Situation in Northern Iraq*. 16 September 1991, Philadelphia: Strategic Studies Institute, U.S. Army War College.
- \_\_\_\_\_, (1992) *The Iran-Iraq War: Chaos in a Vacuum*. New York: Praeger.
- \_\_\_\_\_, (1996) "America and the Emerging Power Vacuum in Northern Iraq." Draft paper, U.S. Army War College.
- Perthe, Volker (1998) *Iraq Under Sanctions: A Regime Defiant*. Middle East Programme Briefing No. 40 (February). London: Chatham House.
- Peters, B. Guy (1995) *The Politics of Bureaucracy*. Fourth edition. New York: Longman Publishers.
- \_\_\_\_\_, (1998) *Comparative Politics: Theory and Methods*. Basingstoke: Macmillan.
- \_\_\_\_\_, (1999) *Institutional Theory in Political Science: The New Institutionalism*. London: Pinter Press.
- Philpott, D. (1997) "Ideas and the Evolution of Sovereignty," in Sohail Hasmi, (ed.), *State Sovereignty: Change and Persistence in International Relations*. Pennsylvania: Pennsylvania State University Press.
- Policy Planning Unit (Durham University Research Team) (1998) *Iraqi Kurdistan: The Socio-Economic Situation and the Humanitarian Aid Programme*. Unpublished report for Department for International Development (DFID), UK.
- Pool, David (1998) "The Eritrean People's Liberation Front," in Christopher Clapham, (ed.); *African Guerrillas*. Oxford: James Currey.
- Premdas, Ralph R., S. W. R. De A. Samarasinghe, and Alan B. Anderson (eds.) (1990) *Secessionist Movements in Comparative Perspective*. International Centre for Ethnic Studies; London: Pinter Press.
- Prince, James M. (1993) "A Kurdish State in Iraq?" *Current History*, Vol. 92, No. 570: 17-22.
- Ra'anan, U. (ed.) (1991) *The Breakup of Multinational State*. Manchester: Manchester University Press.

- Randal, Jonathan C. (1998) *After Such Knowledge, What Forgiveness: My Encounters with Kurdistan*. New York: Farrar, Straus & Giroux.
- Randall, Vicky, (ed.) (1988) *Political Parties in the Third World*. London: Sage Press.
- Ratnam, K. J. (1964) "Charisma and Political Leadership," *Political Studies*, Vol. 12, No. 3, pp. 341-354.
- Ministry of Information (Republic of Iraq) (1974) *Law of Autonomy for Kurdistan Region*. Baghdad: Al-Hurriya Printing House.
- Rodley, Nigel, (ed.) (1992) *To Loose the Bands of Wickedness: International Intervention in Defence of Human Rights*. London: Brassey's.
- Roosevelt, Archie (1978) "The Kurdish Republic of Mahabad," in Gerard Chaliand (ed.) *A People Without a Country: The Kurds and Kurdistan*. New York: Olive Branch Press.
- Rose, Richard (1991) "Comparing Forms of Comparative Analysis," *Political Studies*, Vol. 39, No. 3, pp. 446-462.
- Rumaihi, M. G. (1980) "The Mode of Production in the Arab Gulf Before the Discovery of Oil," in Niblock, T. C., (ed.), *Social and Economic Development in the Arab Gulf*. London: Croom Helm.
- Runciman, W. G. (1989) *A Treatise on Social Theory*. Cambridge: Cambridge University Press.
- Rupesinghe, K. (ed.) (1992) *Internal Conflict and Governance*. London: Macmillan Press.
- Ryan, Stephen (1990b) *Ethnic Conflict and International Relations*. Aldershot: Dartmouth Publishing.
- Safrastian, Arshak (1948) *Kurds & Kurdistan*. London: Harvill Press.
- Sajjadi, M. (1992) "State of Economy in Kurdistan," in Maria T. O'Shea, (ed.) 1992, *Kurdistan: Political and Economic Potential*. London: SOAS.
- Salih, Khalid (1995) "Anfal: The Kurdish Genocide in Iraq." *Digest of Middle East Studies*, vol. 4, no. 2, Spring 1995, pp. 24-39.



- Samarasinghe, S. W. R. de A., and Reed Coughlin (eds.) (1991) *Economic Dimensions of Ethnic Conflict*. London: Pinter.
- Sartori, G. (1976) *Parties and Party Systems*. Cambridge: Cambridge University Press.
- Schechterman, Bernard, and Martin Slann (eds.) (1993) *The Ethnic Dimension in International Relations*. Westport, Conn.: Praeger Publishers.
- Schmidt, Dana Adams (1964) *Journey Among Brave Men*. Boston: Little & Brown.
- Shaw, Martin (1991) "State Theory and the Post-Cold War World," in Michael Banks and Martin Shaw, (eds.), *State and Society in International Relations*. London: Harvester Wheatsheaf.
- Sheikhmous, Omar (1999) "Intra-Kurdish Relations of Kurds of Iraq with Kurds of Other Parts of Kurdistan" in *Irakisch-Kurdistan: Status und Perspektiven. Ergebnisse einer internationalen tagung 1999 in Berlin*, pp. 53-64. Berlin: Awadani e.V.
- Shikara, Ahmad A. R. (1989) *Prospects for Peace in Iraq: The Case of the Kurds and the Question of National Integration*. Symposium on the Post-War Arab Gulf, 12-14 July 1989, Centre for Arab Gulf Studies, University of Exeter.
- Short, Martin, and Anthony McDermott (1977) *The Kurds*. London: Minority Rights Group.
- Shuhrke, Astrid, and Leila Noble (1977) *Ethnic Conflict in International Relations*. New York: Praeger.
- Sills, Marc A., and Glenn T. Morris (eds.) (1993) *Indigenous Peoples' Politics: An Introduction*. Denver, CO: Fourth World Center for the Study of Indigenous Law and Politics, University of Colorado.
- Simi, Richard (1980) "Kurdistan: The Search for Recognition." *Conflict Studies* 124 (November 1980).
- Simons, Geoff (1996) *Iraq: From Sumer to Saddam*. London: Macmillan.

- \_\_\_\_\_, (1998) *The Scourging of Iraq: Sanctions, Law and Natural Justice*. London: Macmillan.
- Sivan, Emmanuel (1975) "The Kurds: Another Perspective," *Case Studies on Human Rights and Fundamental Freedoms: A World Survey*, Vol. 2. The Hague: Martinus Nijhoff.
- Sloan, Geoffrey (1999) "Sir Halford Mackinder: The Heartland Theory Then and Now," in Colin S. Gray and Geoffrey Sloan, (eds.), *Geopolitics: Geography and Strategy*. London: Frank Cass.
- Sluglett, Peter (1989) "The Kurds," in Committee Against Repression and for Democratic Rights in Iraq (ed.) *Saddam's Iraq: Revolution or Reaction?* London: Zed Books.
- Spanier, John W. (1972) *Games Nations Play*. London: Thomas Nelson and Sons.
- Spykman, Nicholas (1944) *The Geography of the Peace*. New York: Harcourt, Brace and Co.
- Stansfield, Gareth R. V. (2000a) "The Political and Economic Development of the *De Facto* Kurdish State in Northern Iraq." *Oxford Analytica Daily Brief*, Vol. 5, 14 April, pp. 14-16.
- \_\_\_\_\_, (2000b) "Iraq: Kurdish Chessboard." *Oxford Analytica Daily Brief*, Vol. III, 2 August, pp. 8-10.
- \_\_\_\_\_, (2000c) "A Qualitative Description and Analysis of Male Potential Asylum Seekers from Erbil (Northern Iraq)" in Efionayi-Mäder, et. al., (eds.), *Distribution of Asylum Requests Over European Countries*. Neuchâtel: Schweizerisches Forum für Migrationsstudien.
- Stichting Nederland-Koerdistan (1996) *Iraqi Kurdistan 1991-1996: Political Crisis and Humanitarian Aid*. Amsterdam: Netherlands Kurdistan Society.
- Stork, Joe (1982) "State Power and Economic Structure: Class Determination and State Formation in Contemporary Iraq," in Tim Niblock, (ed.), *Iraq: The Contemporary State*. London: Croom Helm.
- Suhrke, Astri, and Lela Garner Noble (eds.) (1977) *Ethnic Conflict in International Relations*. New York: Praeger Publications.



Suleiman, Azad (1994) "The Politics of Green and Yellow," *Dialogue*, September 1994.

Talabani, Jalal (1971) *Kurdistan wa al-Haraka al-Qawmiyya al-Kurdiyya*, (Kurdistan and the Kurdish Nationalist Movement). Beirut: Dar al-Talia.

\_\_\_\_\_, (1990) *The Kurdish Movement: The Prospects in the '90s*. Lecture presented to the Royal Institute of International Affairs (Chatham House), London, April 1990.

\_\_\_\_\_, (1993) "Speech by Mr. Talabani, Leader of the Patriotic Union of Kurdistan," in Fuad Hussein, Michiel Leezenberg and Pieter Miller, (eds.), *The Reconstruction and Economic Development of Iraqi Kurdistan: Challenges and Perspectives*. Amsterdam: Netherlands Kurdistan Society.

Talabany, Nouri (1999a) *The Kurdish View on the Constitutional Future of Iraq*. London.

\_\_\_\_\_, (1999b) "The Relationship Between the Kurds and the Central Government in Iraq," in *Irakisch-Kurdistan: Status und Perspektiven. Ergebnisse einer internationalen tagung 1999 in Berlin*, pp. 141-146. Berlin: Awadani e.V.

Taubinger, L. M. Von (1975) "Suffering and Struggle of the Kurds," *Case Studies on Human Rights and Fundamental Freedoms: A World Survey*, Vol. 1. The Hague: Martinus Nijhoff.

Taylor, Peter J. (1996) "The Modern Multiplicity of States," in Eleonore Kofman and Gillian Youngs, (eds.), *Globalization: Theory and Practice*. London: Pinter.

Tayyeb, Abdel Aziz, and Teilly Ameen (1996) *Security Council Resolution 986: Its Implementation in Kurdistan*. Erbil, Iraqi Kurdistan.

Turner, Arthur Campbell (1988), "Kurdish Nationalism," in Peter J. Chelowski and Robert J. Pranger, (eds.), *Ideology and Power in the Middle East: Studies in Honour of George Lencowski*. London: Duke University Press.

- Turpin, Colin (1990) *British Government and the Constitution: Texts, Cases and Materials*. London: Weidenfeld and Nicolson.
- United Nations (1995) *United Nations Consolidated Inter-Agency Humanitarian Cooperation Programme for Iraq: Mid-Term Review*.
- Vanly, Ismet Sheriff, (1980) "Kurdistan in Iraq," in Chaliand, Gerard, (ed.), 1993, *People Without a Country: The Kurds and Kurdistan*. New York: Olive Branch Press.
- Viotti, Paul R. (1974) "Kurdish Insurgency in Iraq," in Bard E. O'Neill, D. J. Alberts, and Stephen J. Rossetti, (eds.), *Political Violence and Insurgency: A Comparative Approach*. Arvada, CO: Phoenix Press.
- \_\_\_\_\_, (1980) "Iraq: The Kurdish Rebellion," in Bard E. O'Neill, William R. Heaton and Donald J. Alberts, (eds.), *Insurgency in the Modern World*. Boulder, CO: Westview Press.
- Vo Nguyen Giap (1965) *People's War People's Army*. New York: Frederick A. Praeger.
- Waldner, David (1999) *State Building and late Development*. Ithaca: Cornell University Press.
- Walker, R. B. J., and Saul H. Mendlovitz, (eds.) (1990) *Contending Sovereignties: Redefining Political Community*. Boulder, CO: Lynne Rienner Publishers.
- Wallace-Bruce, N. L. (1994) *Claims to Statehood in International Law*. New York: Carlton Press.
- Waterbury, John (1970) *Commander of the Faithful*. London: Nicolson and Weidenfeld.
- Weber, Max (1946) "Politics as a Vocation," in H.H. Gerth and C. Wright Mills (eds.) *From Max Weber: Essays in Sociology*. New York: Oxford University Press.
- \_\_\_\_\_, (1968) *On Charisma and Nation-Building*. Chicago, Illinois: Chicago University Press.



- Wimmer, Andreas (1998) "From Subject to Object of History: The Kurdish Movement in Northern Iraq Since 1991." *Between Imagination & Denial: Kurds as Subjects and Objects of Political and Social Processes*, Conference held at the University of Berlin, May 29-31, 1998.
- Wiseman, H. V. (1971) *Political Systems: Some Sociological Approaches*. London: Routledge and Kegan Paul.
- Yalçın-Heckmann, Lâle (1990) "Kurdish Tribal Organisation and Local Political Processes," in Andrew Finkel and Nükhet Sirman, (eds.), *Turkish State, Turkish Society*. London: Routledge.
- Zaid, H. (1970) "The Role of the K.D.P. in the Kurdish Revolution." *Kurdistan* 14, 1970, (The Annual Journal of the Kurdish Students Society in Europe - KSSE): pp. 7-10.
-

## Reference List 2: Interviews, Meetings and Correspondence

The following list includes those people interviewed who were prepared for their names to be quoted. Whilst being extensive, this list does not include those many civil servants within the various offices of the local authorities, and members of the many different parties which I visited. I am extremely grateful to all those named and unnamed for the assistance provided, and also to those people who discussed my thesis with me, provided many useful insights into Kurdish politics and governance, but who have chosen to remain anonymous. With each entry, I have included the commonly referred to name of the person, as it is not unusual for *peshmerga* in particular to have a *nom de guerre*. Their position at the time of interview is noted, along with any subsequent positions, and the place and date of the interview/meeting.

Abdul Aziz, (Mulla) Ali. General Guide of the Islamic United Movement of Kurdistan. Halabja, 7 July 1998.

\_\_\_\_\_, Halabja, 11 October 2000.

Ali, Dler Mohammad. Director General of Irrigation, Erbil. Erbil, 15 July 1998.

Ali, Hadi. Member of KIU (*Yekgertu*) Political Bureau and Minister of Region in the KRG (Erbil) Third Cabinet, Minister of Justice, Fourth Cabinet.

Abdelkadir, Feyeradun. Member of PUK Political Bureau and founder member of the *Komala*. Suleimaniyah, 10 August 1999.

Abdullah, Krekar. Director-General of Agricultural Services, Ministry of Agriculture, Suleimaniyah. Suleimaniyah,

Abdullah, Rafad. Minister of Finance and Economic Affairs, KRG (Suleimaniyah), later, Minister of Industry and Power, later Governor of New Kirkuk. Suleimaniyah, 9 July 1998.

\_\_\_\_\_, Suleimaniyah, 2 May 2000.

Abdullah, Sa'ad. Member of KDP Central Committee, head of Branch Two – Erbil, Minister of Agriculture, Fourth Cabinet (Erbil). Erbil, 25 August 1998.

\_\_\_\_\_, Erbil, 24 August 1999.



\_\_\_\_\_, Erbil, 9 September 1999.

Abdul Rahman, Sami. Senior Member of KDP Political Bureau Steering Committee, previously Minister of Northern Affairs in Baghdad, Secretary-General of KDP-PL, and leader of the KPDP (*Parti Gel*). Deputy Prime Minister, KRG Fourth Cabinet (Erbil). Salahadin, 23 March 1998.

\_\_\_\_\_, Salahadin, 3 April 1998.

\_\_\_\_\_, Salahadin, 27 June 1998 (Sa'ad Abdullah also present).

\_\_\_\_\_, Salahadin, 29 August 1999 (Falah Mustafa also present).

\_\_\_\_\_, Salahadin, 8 September 1999.

\_\_\_\_\_, Salahadin, 9 September 1999 (Arif Taifour also present).

\_\_\_\_\_, Erbil, 12 March 2000.

\_\_\_\_\_, Erbil, 27 March 2000.

\_\_\_\_\_, Erbil, 15 April 2000.

\_\_\_\_\_, Erbil, 24 April 2000 (Ibrahim Hassan also present).

\_\_\_\_\_, Salahadin, 1 August 2000 (Bruska Nuri Shawaise and Karim Sinjari also present).

\_\_\_\_\_, Erbil, 27 August 2000.

Ahmed, Imad. Minister of Health and Social Affairs, KRG (Suleimaniyah), later, Minister of Industry and Power (1999), member of PUK Political Bureau. Suleimaniyah, 8 July 1998.

Ahmed, Karim. Member of Political Bureau, Kurdistan Communist Party. Erbil, 11 June 1998.

Ahmed, Nechervan. Governor of Dohuk (2000). Dohuk, 17 April 2000.

Ali, Mohammad. Director of Surveys, Suleimaniyah. Suleimaniyah, numerous meetings from 1997 to 2000.

Ali, Omar Sa'id. Member of PUK Political Bureau, Head of *Melbendi Yek* (Suleimaniyah). Suleimaniyah, 20 June 1998.

Amin, Nawsherwan Mustafa. Member of PUK Political Bureau; previously leader of the *Komala*. Recognised as unofficial Deputy Secretary-General. London, 5 March 1999.

\_\_\_\_\_, Suleimaniyah, 29 July 1999.

\_\_\_\_\_, Suleimaniyah, 10 August 1999.

\_\_\_\_\_, Suleimaniyah, 17 March 2000.

\_\_\_\_\_, Suleimaniyah, 20 June 2000.

Askari, Chalaw Ali. Deputy Minister of Humanitarian Affairs and Cooperation (Suleimaniyah), later Deputy-Minister of Agriculture (Suleimaniyah), then adviser to Jalal Talabani on NGO operations. Son of Ali Askari. Suleimaniyah, 3 March 1998.

\_\_\_\_\_, Suleimaniyah, 17 April 1998.

\_\_\_\_\_, Suleimaniyah, 2 May 1998.

\_\_\_\_\_, Suleimaniyah, 13 May 1998.

\_\_\_\_\_, Suleimaniyah, 10 June 1998.

\_\_\_\_\_, Suleimaniyah, 9 July 1998.

Aziz, Billal. Former member of KDP Central Committee. Erbil, 18 July 1998.

Baghstani, Daoud. Independent, has been connected with most Kurdish parties and neighbouring countries. Erbil, 18 April 1998.

\_\_\_\_\_, Erbil, 22 April 1998.

\_\_\_\_\_, Erbil, 30 May 1998.

Bahjat, Roj. Director General of Public Relations, Ministry of Humanitarian Affairs and Cooperation, Suleimaniyah. Suleimaniyah, 10 September 2000.

Bakr, Falah Mustafa. Public Relations Officer of the Political Bureau of the KDP and, since July 1999, Deputy-Minister of Agriculture. Salahadin, 18 January 1998.

\_\_\_\_\_, Salahadin, 14 February 1998.

\_\_\_\_\_, Salahadin, 22 February 1998.



\_\_\_\_\_, Salahadin, 21 May 1998.

\_\_\_\_\_, Erbil, 9 March 2000.

Bapir, Ali. Member of the leadership of the IMK. Halabja, 8 August, 1998.

Barmani, Shawkat. Public Relations Officer of the KDP in Dohuk. Numerous meetings, 1998-2000.

Barwari, Nasreen. Minister of Reconstruction and Development, KRG (Erbil) Fourth Cabinet. Erbil, 13 March 2000.

Barzani, Massoud. President of the Kurdistan Democratic Party. Saryrash, Salahadin, 22 August 1999.

\_\_\_\_\_, Saryrash, 27 August 2000.

Barzani, Nechervan. Prime Minister, KRG fourth cabinet (Erbil); member of KDP Political Bureau Steering Committee. Saryrash, Salahadin, 21 May 1998.

\_\_\_\_\_, Saryrash, 22 October 2000.

Bayez, Arsalan. Member of PUK Political Bureau; previously Minister of Education, KRG (Suleimaniyah). Suleimaniyah, 24 May 1998.

\_\_\_\_\_, Suleimaniyah, 18 June 1998.

Binyamin, Shmael. Member of Central Committee of the Assyrian Democratic Movement (ADM) and Member of Parliament in the KNA. Ainkawa, Erbil, 3 April 2000.

Brifkani, Shiekh Ma'amoon. Minister of Reconstruction and Development, KRG third cabinet (Erbil). Minister of Municipalities and Tourism, fourth cabinet. Erbil, 20 May 1998.

\_\_\_\_\_, Erbil, 26 March 2000.

Council of Ministers. Suleimaniyah. 2 April 2000.

Dizayi, Muhsin. Adviser to Massoud Barzani and senior member of the KDP. Salahadin, 24 August 1999.

\_\_\_\_\_, Salahadin, 30 May 2000.

Farman, Jabar. Member of PUK Political Bureau, Deputy-Commander of PUK Peshmerga. Suleimaniyah, 18 June 1998.

\_\_\_\_\_, Suleimaniyah, 18 June 1998 (evening).

\_\_\_\_\_, Suleimaniyah, 30 August 1998.

Fattah, Kawa. Member of Kurdistan Communist Party Political Bureau. Erbil, 13 June 1998.

Fu'ad, Jamal. Minister of Humanitarian Affairs and Cooperation, KRG (Suleimaniyah).

Fu'ad, Kamal. Senior member of PUK Political Bureau; Deputy-Prime Minister of KRG (Suleimaniyah) during 1997-8. Suleimaniyah, 3 May 1998.

\_\_\_\_\_, Suleimaniyah, 7 July 1998.

Gaylard, Maxwell. Deputy Coordinator of Humanitarian Affairs, UN Office of the Humanitarian Coordinator of Iraq (UNOHCI). Erbil, 23 January 1998.

\_\_\_\_\_, Erbil, 8 February 1998.

Gunter, Michael. American academic authority on Kurdish political history. Berlin, April 1999.

Haji Ali, Kamil. Member of IMK Political Bureau. Halabja, 19 June 1998.

\_\_\_\_\_, Halabja, 12 October 2000.

Hama Jan, (Hackam) Khadr. Governor of Suleimaniyah. Suleimaniyah, 4 March 1998.

\_\_\_\_\_, Suleimaniyah, 2 May 2000.

\_\_\_\_\_, Suleimaniyah, 6 September 2000.

Hariri, Franso. Governor of Erbil, member of KDP Central Committee, Minister of State (third cabinet), Member of Parliament, later, head of Branch Two – Erbil (*Leqi Du*) KDP. Erbil, 14 April 1998.

\_\_\_\_\_, Erbil, 23 April 1998.

\_\_\_\_\_, Erbil, 22 August 2000.



- Hassan, Ibrahim. KDP Public Relations Officer of the Political Bureau. Salahadin, 13 March 2000.
- \_\_\_\_\_, Salahadin, 24 June 2000.
- Hikmat, Abu. Minister of Agriculture, KRG (Erbil) third cabinet. Erbil, 9 May 1998.
- Hussein, Bahman. Minister of Works and Reconstruction, KRG (Suleimaniyah). Member of Kurdistan Toilers' Party. Suleimaniyah, 11 July 1998.
- \_\_\_\_\_, Suleimaniyah, 15 March 2000.
- Hussein, Fu'ad. Academic, consultant, based in Amsterdam. Dokan, 5 May 2000.
- Ibrahim, Siddig. Observer, UNICEF Erbil. Erbil, 24 February 1998.
- Ja'afer, Sheikh. Deputy Minister of *Peshmerga* Affairs, KRG (Suleimaniyah), one of the most famous *peshmerga* commanders of the PUK in the 1980s.
- Jabari, Khadir. Minister of Justice, third cabinet KRG (Erbil); previously member of KPDP. Erbil, 30 June 1998.
- Jawher, Jalal. Governor of New Kirkuk (Darbandikhan), later Minister of Municipalities and Tourism (2000). Darbandikhan, 3 March 1998.
- \_\_\_\_\_, Suleimaniyah, 1 April 2000.
- Khaliq, Massoud Abdel. Ex-member of PUK. Erbil, 22 June 1998.
- \_\_\_\_\_, Erbil, 15 July 1998.
- Khanaqa, Sheelan. Public Relations Director of the Ministry of Humanitarian Affairs and Cooperation (Suleimaniyah) and, later, Public Relations Director of the Council of Ministers (Suleimaniyah). Numerous meetings between 1997 and 2000.
- Khoshnaw, Kamal. President of University of Suleimaniyah; important figure in the founding and early development of the PUK. Suleimaniyah, 14 May 1998.
- \_\_\_\_\_, Suleimaniyah, 20 June 1998.
- Khoshnaw, Mahdi. Deputy-Governor of Erbil. Erbil, 16 February 1998.
- \_\_\_\_\_, Erbil, 14 April 1998.

- \_\_\_\_\_, Erbil, 5 June 1998.
- \_\_\_\_\_, Erbil, 30 June 1998.
- \_\_\_\_\_, Erbil, 8 March 2000.
- \_\_\_\_\_, Erbil, 18 April 2000.
- \_\_\_\_\_, Erbil, 17 August 2000.
- \_\_\_\_\_, Erbil, 22 August 2000.
- Maldmur, Rafoul. Member of Political Bureau of the YNDK (United Nationalist Democratic Party). Erbil, 15 June 1998.
- Mantik, Akram. Governor of Erbil (2000), member of KDP Central Committee and previously responsible for security issues. Erbil 18 April 2000.
- \_\_\_\_\_, Erbil, 17 August 2000.
- Marr, Phebe. American expert on Iraq. Regular communication. Meetings include:  
Saryrash, Salahadin, 22 August 1998.
- \_\_\_\_\_, Suleimaniyah, 28 August 1998.
- \_\_\_\_\_, Durham, UK, 9 July 1999.
- \_\_\_\_\_, Washington DC, 16 December 1999.
- Massoum, Fu'ad. Prime Minister of the first cabinet, KRG; Former head of *Shoresh Garan*. Head of PUK Overseas. London, 2 June 1999.
- Mawati, Hama Rashid. Member of the Leadership Council of the KIU (*Yekgurtu*). Erbil, 17 August 1999.
- McCormick, Suzanne. Political analyst, US Department of State, Washington DC, 20 December 1999.
- Merani, Fadhil. Minister of Interior, KRG (Erbil), member of KDP Political Bureau. Erbil, 26 August 1999.
- Miran, Delshad. Member of KDP Europe. London, 3 February 2000.
- Mohammad, Aziz. Ex-Secretary General of the Kurdistan Socialist Party. Mediator between KDP and PUK at the Shaqlawa / Koysanjaq meetings. Erbil, 18 August 1999.



Mortier, Gerhard. Field Delegate (Erbil), UNOHCI. Erbil, 23 January 1998.

\_\_\_\_\_, Erbil, 9 March 1998.

Mufti, Kamal. Minister of Peshmerga Affairs, KRG (Suleimaniyah). Acting Prime Minister. Suleimaniyah, 9 June 1998.

Mustafa, Bakr. Governor of Erbil in Koysinjaq. Koysinjaq, 2 May 2000.

Mustafa, Khasrow. Minister of Education, Acting Minister of Humanitarian Aid and Cooperation, KRG (Suleimaniyah). Suleimaniyah, 30 March 2000.

Nasr, Adil. Minister of Agriculture and Irrigation, KRG (Suleimaniyah). Previously Deputy-Governor of Dohuk. Suleimaniyah, 15 March 2000.

\_\_\_\_\_, Malouma (Suleimaniyah), 31 March 2000.

\_\_\_\_\_, Suleimaniyah, 13 July 2000.

Nuri, Aso Sheikh. Deputy-Governor of Suleimaniyah. Suleimaniyah, 5 May 1998.

Nurisi, Abdul Rahman. Minister of Justice, KRG (Suleimaniyah); member of IMK. Suleimaniyah, 19 July 1998.

Olson, Robert. American academic authority on Kurdish history. Washington DC, 15-16 December 1999.

Osman, Badrea. Director of Planning, Ministry of Agriculture, KRG (Erbil). Erbil, 1 July 1998.

Pira, Sa'adi Ahmed. Minister of Humanitarian Affairs and Cooperation, KRG (Suleimaniyah) and member of PUK Central Committee. Head of PUK Foreign Relations Bureau. Suleimaniyah, 4 March 1998.

\_\_\_\_\_, Suleimaniyah, 17 April 1998.

\_\_\_\_\_, Suleimaniyah, 6 May 1998.

\_\_\_\_\_, Suleimaniyah, 9 June 1998.

\_\_\_\_\_, Berlin, April 1999.

\_\_\_\_\_, Suleimaniyah, 14 April 2000.

\_\_\_\_\_, Dokkan (Suleimaniyah Governorate), 5 May 2000.

\_\_\_\_\_, Suleimaniyah, 7 June 2000.

\_\_\_\_\_, Suleimaniyah, 10 June 2000.

\_\_\_\_\_, Suleimaniyah, 18 June 2000.

\_\_\_\_\_, Suleimaniyah, 20 June 2000.

\_\_\_\_\_, Suleimaniyah, 29 June 2000.

Qazzaz, Shafiq. Minister of Humanitarian Affairs and Cooperation, KRG (Erbil).

Erbil, 9 February 1998.

\_\_\_\_\_, Erbil, 28 February 1998.

\_\_\_\_\_, Erbil, 19 May 1998.

\_\_\_\_\_, Erbil, 27 August 2000.

Qliasani, Shwan. Deputy-Head of PUK Foreign Relations Bureau. Suleimaniyah, 3

May 1998.

\_\_\_\_\_, Suleimaniyah, 5 May 1998.

\_\_\_\_\_, Suleimaniyah, 14 May 1998.

\_\_\_\_\_, Suleimaniyah, 18 June 1998.

\_\_\_\_\_, Suleimaniyah, 4 August 1999.

\_\_\_\_\_, London, 11 November 1999.

\_\_\_\_\_, Durham, 18 November 1999.

\_\_\_\_\_, Suleimaniyah, 15 March 2000.

\_\_\_\_\_, Suleimaniyah, 14 April 2000.

\_\_\_\_\_, Suleimaniyah, 25 August 2000.

Rashid, Latif. PUK Representative, London. London, 15 February 1999.

\_\_\_\_\_, London, 4 March 1999.

\_\_\_\_\_, London, 4 February 2000.

Rashidian, Khalil. Kurdish academic. Durham, UK, numerous meetings throughout

1996-1999.



Rasoul, Kosrat. Prime Minister of the second (Erbil) and third (Suleimaniyah) cabinets of the KRG and member of PUK Political Bureau. Suleimaniyah, 3 March 1998.

\_\_\_\_\_, Suleimaniyah, 8 August 1999.

\_\_\_\_\_, Suleimaniyah, 28 March 2000.

\_\_\_\_\_, Suleimaniyah, (Arsalan Bayez, Sa'adi Pira and Shwan Qliasani also present), 1 April 2000.

\_\_\_\_\_, Suleimaniyah, 23 May 2000.

\_\_\_\_\_, Suleimaniyah, 26 August 2000.

\_\_\_\_\_, Suleimaniyah, 26 August 2000 (the *peshmerga* commanders Mam Rostam and Kak Ja'afar were present, as was Sa'adi Pira, Shwan Qliasani and Sheelan Khanaqa).

\_\_\_\_\_, Suleimaniyah, 1 October 2000.

\_\_\_\_\_, Suleimaniyah, 15 October 2000.

Rasoul, Mustafa. Director of Kurdish Life Aid (KLA). Numerous meetings throughout 1997-1999 in Iraqi Kurdistan and the UK.

Rasoul, Osman. Field Coordinator of Kurdish Life Aid (KLA). Numerous meetings throughout 1997-1999 in Iraqi Kurdistan and the UK.

Saleh, Barham. Representative of PUK to Washington DC, adviser to Jalal Talabani and Kosrat Rasoul. Suleimaniyah, 3 November 2000.

Saleh, Idris Hadi. Minister of Power and Industry, KRG (Erbil); previously in first and second cabinets. Erbil, 19 May 1998.

Salim, Jawher Namiq. Speaker of Parliament, member of KDP Political Bureau. Head of Steering Committee of the Political Bureau after the Twelfth Congress (October 1999). Erbil, 3 June 1998.

\_\_\_\_\_, Erbil, 24 August 1998.

\_\_\_\_\_, Erbil, 8 September 1999.

Schwartz, David. Iraq Desk Officer, US Department of State, Washington DC, 20 December 1999.

- Sergalu, Mohammad. Ex-member and *peshmerga* of *Shorj Garan*. London, 11 November 1999.
- \_\_\_\_\_, Suleimaniyah, 9 August 2000.
- Shakir, Kamal. Minister of Health and Social Affairs, Third Cabinet of the KRG (Erbil). Also member of the Kurdistan Communist Party. Erbil, 21 May 1998.
- Sharif, Ahmed. Deputy-Minister of Agriculture, KRG (Suleimaniyah). Suleimaniyah, 13 May 1998.
- Shawaise, Bruska Nuri. Adviser to Nechervan Barzani. Salahadin, 1 August 2000.
- Shawaise, Rast Nuri. Deputy-Minister of Public Works and Housing, KRG (Erbil), advisor to Massoud Barzani and (briefly) Governor of Suleimaniyah during September 1996. Erbil, 25 April 1998.
- Shawaise, Roj Nuri. Prime Minister, third cabinet KRG (Erbil), and member of KDP Political Bureau. Later, Speaker of KNA. Erbil, 26 August 1999.
- \_\_\_\_\_, Erbil, 6 September, 1999.
- Sheikhallah, Sheikhallah Ibrahim. Deputy-Minister of Agriculture, KRG (Erbil). Erbil, 1 July 1998.
- Sheikhmous, Omar. Kurdish academic, one of the founding fathers of PUK. Suleimaniyah, 8 October 2000.
- Sinjari, Hussein. Minister of Municipalities and Tourism, KRG (Erbil). Erbil, 13 April 1998.
- \_\_\_\_\_, Erbil, 15 April 1998.
- \_\_\_\_\_, Erbil, 18 April 1998.
- \_\_\_\_\_, Erbil, 29 May 2000.
- Sinjari, Karim. Member of KDP Central Committee, Chief of KDP Security Service (*Rechkrastin Taybet*). Salahadin, 30 May 2000.
- Taifour, Arif. Member of the Political Bureau of the KDP. Salahadin, KDP Political Bureau, 1 September 1999.



Tahir, Ibrahim. Member of IMK Political Bureau, Commander of IMK Peshmerga.

Halabja, 19 June 1998.

Talabani, Jalal. Secretary-General of the Patriotic Union of Kurdistan. Kalarcholan,

14 September 1999 (Sa'adi Pira and Shwan Qliasani also present).

\_\_\_\_\_, Suleimaniyah, 29 August 2000.

\_\_\_\_\_, Kalarcholan, 5 September 2000.

\_\_\_\_\_, Suleimaniyah, 11 September 2000.

Tawfiq, Mohammad. Member of PUK Political Bureau; previously Minister of

Humanitarian Affairs and Cooperation (1<sup>st</sup> Cabinet), ex Vice-

Chairman of the Kurdistan National Assembly. Suleimaniyah, 14 May

1998 (morning).

\_\_\_\_\_, Suleimaniyah, 14 May 1998 (evening).

\_\_\_\_\_, Kalarcholan, 7 August 1999.

Tayyib, Abdel Aziz. Governor of Dohuk. Minister of Education, Fourth Cabinet,

(Erbil). Dohuk, 10 May 1998.

Wimmer, Andreas. German academic expert on Kurdish anthropology. Erbil, August

1997.

\_\_\_\_\_, Oxford, UK, December 1998.

Yaphe, Judith. American academic expert on Iraq. Washington DC, 16 December

1999.

Yazdeen, Shawkat Sheikh. Minister of Finance and Economic Affairs (Third

Cabinet, Erbil), Cabinet Minister (Fourth Cabinet, Erbil), member of

KDP Political Bureau. Erbil, 11 July 2000.

Zebari, Hoshyar. Member of KDP Political Bureau, KDP Foreign Relations. London,

3 February 2000.

\_\_\_\_\_, Salahadin, 22 May 2000

\_\_\_\_\_, Salahadin, 29 May 2000.

### Reference List 3: BBC Summary of World Broadcasts - Middle East

- 7.3.91 Voice of the People of Kurdistan, Suleimaniyah, *PUK radio reports uprising in Suleimaniyah*. SWB ME/1016; 9.03.91.
- 8.3.91 Voice of the People of Kurdistan, Suleimaniyah, *PUK radio lists "liberated" towns and areas*. SWB ME/1017; 11.03.91.
- 3.4.91 Republic of Iraq Radio, Baghdad, *Official Statement Says State's Authority has been Restored in Northern Iraq*. SWB ME/1038; 5.4.91.
- 17.6.91 Voice of the People of Kurdistan, Suleimaniyah, *Barzani Gives Details of Iraqi-Kurdish Agreement on Autonomy and Democracy*. SWB ME/1102; 19.6.91
- 9.9.91 Agence France Presse, Paris, *Senior Kurdish source says autonomy talks have reached a "dead end"*. SWB ME/1173; 10.10.91.
- 9.10.91 Voice of the People of Kurdistan, Suleimaniyah, *PUK Radio Reports on Cease Fire Agreement with Baghdad*. SWB ME/1200; 11.10.91.
- 23.1.92 Voice of Rebellious Iraq, Salahadin, *Kurdistan Front Asks Observers to Attend Elections in Northern Iraq*. SWB ME/1288; 27.1.92.
- 10.5.92 Voice of Rebellious Iraq, Salahadin, *Kurdish Party Leaders Agree on Cooperation During Elections*. SWB ME/1378; 12.5.92.
- 21.5.92 Agence France Press, Paris, *Kurdish Leaders Hold Talks on Coalition to Share Power*. SWB ME/1387; 22.5.92.
- 26.5.92 Voice of Unification, Salahadin, *Kurdish Parties Vow to Cooperate Despite Alleged Rigging of Elections*. SWB ME/1392; 28.5.92.
- 8.7.92 Agence France Press, Paris, *Objectives of Kurdish Cabinet Outlined by Chairman Fu'ad Ma'sum*. SWB ME/1429; 10.7.92.
- 27.11.92 Voice of the People of Kurdistan, Salahadin, *Kurdistan Ministerial Council Establishes Court of Appeal*. SWB ME/1551; 30.11.92.
- 26.4.93 Voice of the People of Kurdistan, Salahadin, *Kurdish Parliament Announces Formation of New Government*. SWB ME/1674; 28.4.93.
- 21.12.93 Voice of the People of Kurdistan, Salahadin, *Law Forming Presidential Council*. SWB ME/1880; 24.12.93.



- 28.5.94 **Voice of Iraqi Kurdistan, Salahadin, KDP Radio Criticizes PUK Media Attacks and Policies.** SWB ME/2009; 30.5.94.
- 28.6.94 **Voice of the Islamic Republic of Iran, Tehran, Tehran Radio Says "So-Called Kurdish Government" in Iraqi Kurdistan has "Disintegrated".** SWB ME/2035; 30 June 1994.
- 1.1.95 **Voice of Iraqi Kurdistan, Salahadin, KDP Blames PUK for Continued Fighting.** SWB ME/2191; 3.1.95.
- 3.1.95 **Voice of the People of Kurdistan, Suleimaniyah, PUK Radio Holds KDP Responsible for Collapse of Agreement.** SWB ME/2193; 5.1.95.
- 4.1.95 **Voice of the People of Kurdistan, Suleimaniyah, PUK Explains Reasons for Fighting, Blames KDP.** SWB ME/2194; 6.1.95.
- 8.3.95 **Voice of Iraqi Kurdistan, Salahadin, KDP Ministers Says Kurdish Government "Paralysed", Acts by PUK Ministers Invalid.** SWB ME/2248; 10.3.95.
- 15.7.95 **Middle East News Agency, Cairo, Kurdish sources say Iran is backing Talabani against Barzani.** SWB ME/2357; 17.7.95.
- 15.7.95 **Iraqi News Agency, Baghdad, Ministry spokesman says Iranian contact with Kurds violation of Iraqi sovereignty.** SWB ME/2357; 17.7.95.
- 31.12.95 **Voice of the People of Kurdistan, Suleimaniyah, PUK Radio Says KDP Accepted Supplies from Government.** SWB ME/2499; 3.1.96.
- 29.1.96 **Voice of the People of Kurdistan, Suleimaniyah, PUK Leader Talabani Says KDP "Trying to Switch" Confrontation with Baghdad.** SWB ME/2523; 30.1.96.
- 7.3.96 **Al-Hayat, London, KDP Attacks PUK's Attempts to "Fabricate" Report of Meeting with Iraqi Minister.** SWB ME/2556; 9.3.96.
- 30.7.96 **Arm the Spirit Information Service, Statement reportedly from KDPI describes Iranian operation into northern Iraq.** SWB ME/2681; 03.08.96.
- 17.8.96 **Voice of Iraqi Kurdistan, Salahadin, KDP Says PUK Launched "Large-Scale" Offensive.** SWB ME/2694; 19.8.96.
- 22.8.96 **Voice of the People of Kurdistan, Suleimaniyah, PUK Says that it is not it but the KDP Which is Receiving Support from Iran.** SWB ME/2699; 24.8.96.

- 22.8.96 **Voice of Iraqi Kurdistan, Salahadin, KDP Radio Says PUK Receiving Iranian Support in Return for Help Against KDPI.** SWB ME/2699; 24.8.96.
- 6.9.96 **Radio Monte Carlo, Paris, KDP Official Says Arrangement with Baghdad was for "Limited Period".** SWB ME/2712; 9.6.96.
- 8.9.96 **Voice of Iraqi Kurdistan, Salahadin, KDP Radio Announces 'Liberation' of Koysinjaq.** SWB ME/2713; 10.9.96.
- 9.9.96 **Iraqi TV, Baghdad, Suleimaniyah KDP Sends Saddam Husayn Cable of Support.** SWB ME/2714; 11.9.96.
- 9.9.96 **Islamic Republic News Agency, Tehran, Iranian News Agency Reports PUK's Abandonment of Suleimaniyah to KDP.** SWB ME/2714; 12.9.96.
- 10.9.96 **Voice of Iraqi Kurdistan, Salahadin, KDP Radio Reports Darbandikhan and Kifri Captured.** SWB ME/2715; 12.9.96.
- 16.9.96 **Al-Hayat, London, KDP Leader Barzani Comments on Conflict with PUK, Ties with Government.** SWB ME/2720; 18.9.96.
- 16.9.96 **Islamic Republic News Agency, Tehran, PUK Radio Begins Broadcasting Again, Calls for Clandestine Resistance.** SWB ME/2719; 17.9.96.
- 16.9.96 **Islamic Republic News Agency, Tehran, PUK Calls on Iraqi Kurds to Unite, Drive Out 'Mercenaries'.** SWB ME/2720; 18.9.96.
- 16.9.96 **Voice of Iraqi Kurdistan, Salahadin, Kurdish Parliament Nominated Prime Minister of Kurdistan Region.** SWB ME/2720; 18.9.96.
- 22.9.96 **Milliyet, Istanbul, Talabani Says PUK Does Not Recognise New Kurdish Government, Parliament.** SWB ME/2725; 24.9.96.
- 23.9.96 **Voice of the People of Kurdistan, Suleimaniyah, PUK Forces Reportedly Repulse 'Large Scale' KDP Attack.** SWB ME/2726; 25.9.96.
- 26.9.96 **Voice of Iraqi Kurdistan, Salahadin, New Government Announced in Kurdistan Region.** SWB ME/2729; 28.9.96.
- 13.10.96 **Voice of the People of Kurdistan, Suleimaniyah, PUK Radio Announces Recapture of Suleimaniyah.** SWB ME/2743; 15.10.96.



- 14.10.96 Radio Monte Carlo, Paris, *PUK Recaptures Suleimaniyah*. SWB ME/2742; 14.10.96.
- 27.1.97 Voice of Iraqi Kurdistan, *Salahadin, KDP Says PUK Appointment of New Ministers Has "No Legal Grounds"*. SWB ME/2829; 27.1.97.
- 9.8.97 Voice of Iraqi Kurdistan, *Salahadin, KDP Dismisses Two Islamist Ministers from Kurdistan "Government"*. SWB ME/2994; 11.8.97.
- 13.10.97 Radio Monte Carlo, Paris, *KDP official says fighting started by PUK*. SWB ME/3050; 15.10.97.
- 13.10.97 Voice of the People of Kurdistan, *Suleimaniyah, PUK radio gives details of 13<sup>th</sup> October clashes with KDP*. SWB ME/3050; 15.10.97.

