

**WÊNESAZÎ**

**SERETAYÎ**

**2**

2019/2020



## AMADEKAR

Ev pirtûk ji aliyê Komîteya  
Wênesaziyê ve hatiye  
amadekirin.

## LÊVEGER

- Komîteya Şopandinê
- Komîteya Fotoşopê
- Komîteya Redekteyê

Ev pirtûk ji aliyê Saziya Minhacan  
ve, wek pirtûka wanedayînê, ji bo  
dibistanan hatiye pejirandin.





## NAVEROK

TEVLIHEVKIRINA RENGAN .....	7
TEŞEYÊN GEOMETRÎK.....	9
RÊBAZÊ RENGÎNKIRINÊ.....	11
WERDEK.....	13
KÎSO .....	15
PINPINÎK.....	17
XALXALOK.....	19
SIMBIL.....	21
DAR .....	23
JI ÇARGOŞEYÊ ÇÊKIRINA RÛYEKÎ .....	25
SOBE .....	27
MÊZE Û RÛNIŞTEK .....	29
GULDANK.....	31
DEMJIMÊR.....	33
LÎSTINA BI HEVALAN RE.....	35
PAQIJÎ .....	37
SEBZE .....	39
ROHILATIN.....	41
MÛMEK JI KOLACÊ.....	43
GULEK JI KOLACÊ.....	45



## WANE 1

### TEVLIHEVKIRINA RENGAN

Em ê di vê waneyê de, rengên resen û yêni dariştî nas bikin. Her wiha em ê di rêya tevlihevkirina rengan de rengên nû saz bikin.

**Rengên Resen**

**Rengên Dariştî**

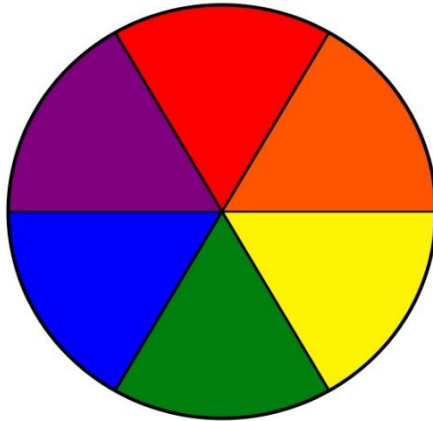
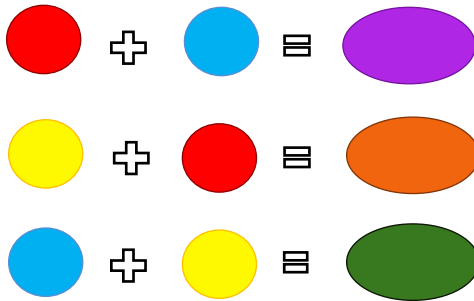

## RAHÊNAN

Ka em bi hev re vî teşeyê li jêr, li ser lînûsa wênesaziyê saz bikin û bi rengên resen rengîn bikin; da ku di encamê de rengên dariştî xuya bibin.

### Amûrên Pêwîst:

Lînûsa wênesaziyê, pênûsa risas, pênûsên rengîn, jêbir û pênûsbir.

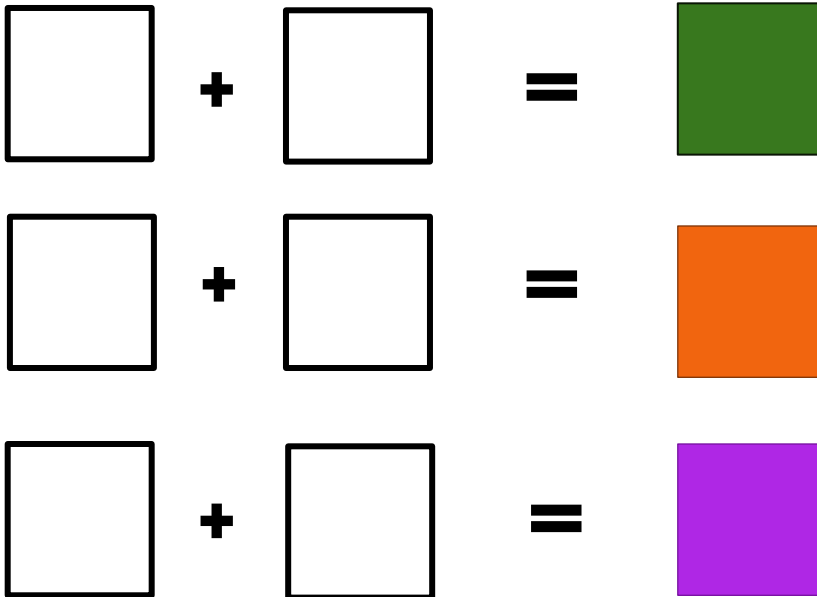



## WANE 2

# TEŞEYÊN GEOMETRÎK

Bi alîkariya teşeyên geometrîk, em dikarin teşeyên cur bi cur saz û nîgar bikin. Ka em bi hev re, hinekan ji wan nas bikin.

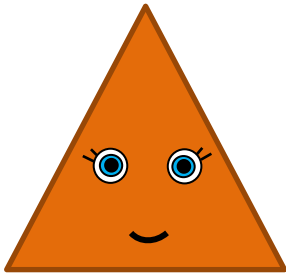

Sêgoşe

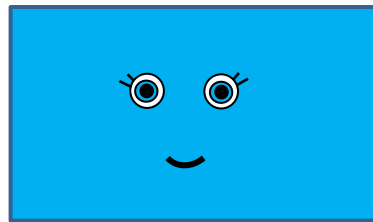

Milkêş

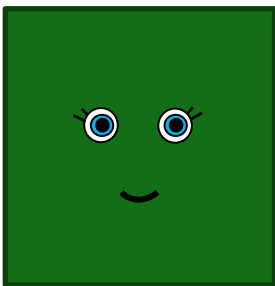

Dam

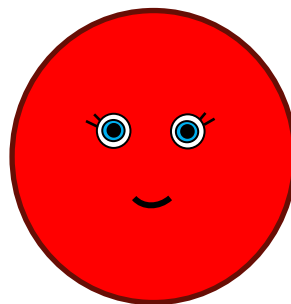

Girover

## RAHÊNAN

Piştî ku, em fêrî hin teşeyên geometrîk bûn, ka em niha bi alîkariya sêgoşe, milkêş û çargoşeyê xaniyekî mîna vî xaniyê li jêr, li ser lênûsa wênesaziyê, xêz û rengên bikin.

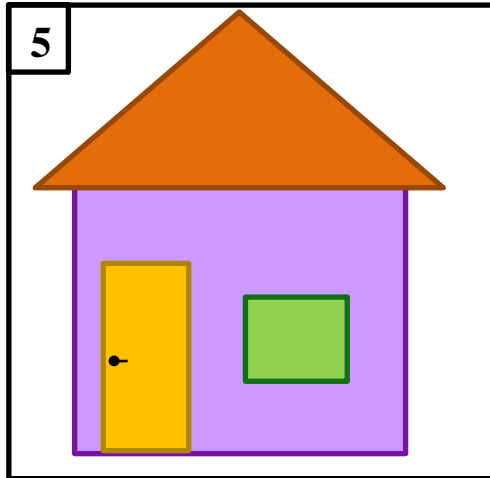
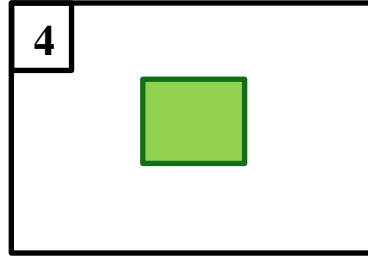
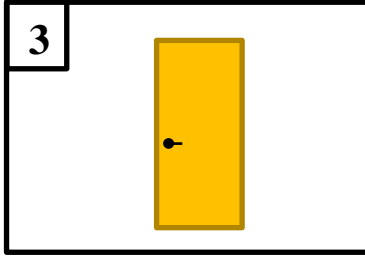
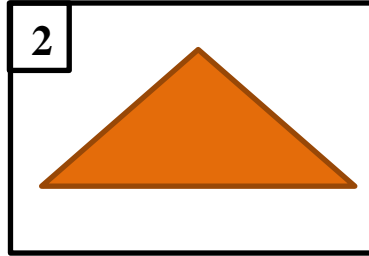
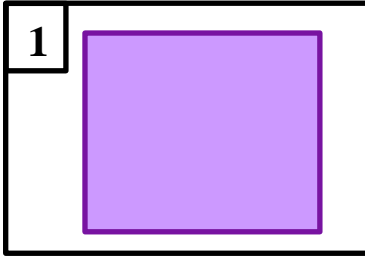

## WANE 3

### RÊBAZÊ RENGÎNKIRINÊ

Di rêbazê rast ê rengînkirinê de, em van her du xalan di ber çavan re derbas dikin:

- 1- Divê tevgera pêûsê di heman aliyê de be.
- 2- Divê xêzên rengan dernekevin derveyê teşeyê.

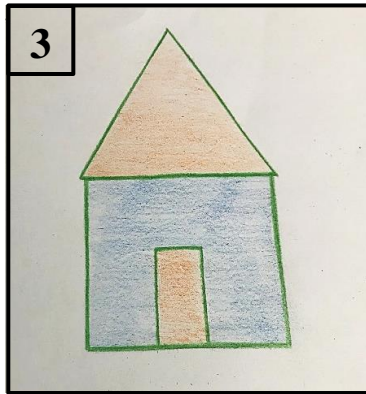
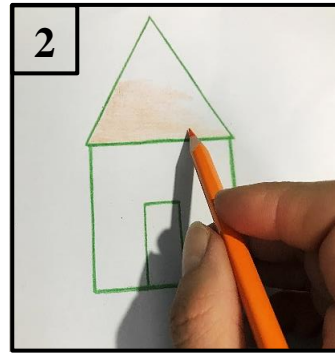
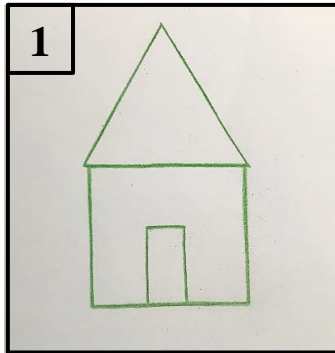

## RAHÊNAN

Wênesazê jîr, li van her du teşeyên li jêr baş binêre, paşê li ser lênûsa wênesaziyê teşeyekî saz bike. Hewil bide ku tu bi rêbazê rast rengîn bikî; da ku nîgar bi rêkûpêk û xweşik be.

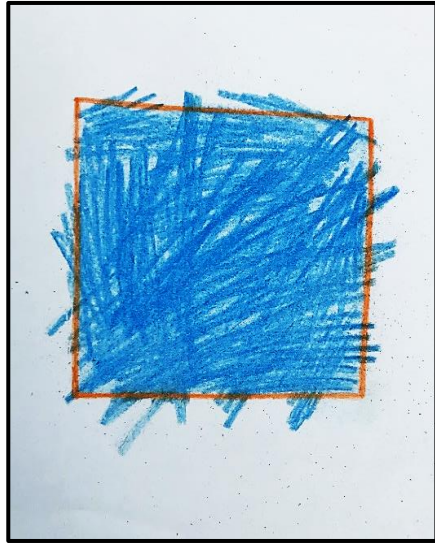
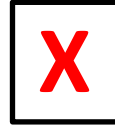
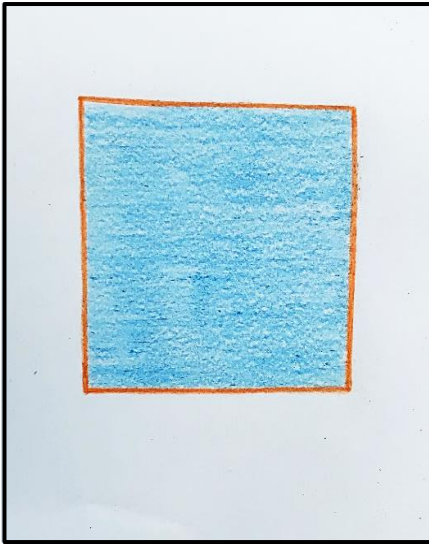

## WANE 4

### WERDEK

Werdek: Firindeyeke bejavî ye, gelek rengên wê hene. Ka em bi hev re wê nas bikin û fêrî nîgarkirina wê bibin.



## RAHÊNAN

Em ê li gor van gavên li jêr, werdekekê li ser lînûsa wênesaziyê xêz û rengîn bikin.

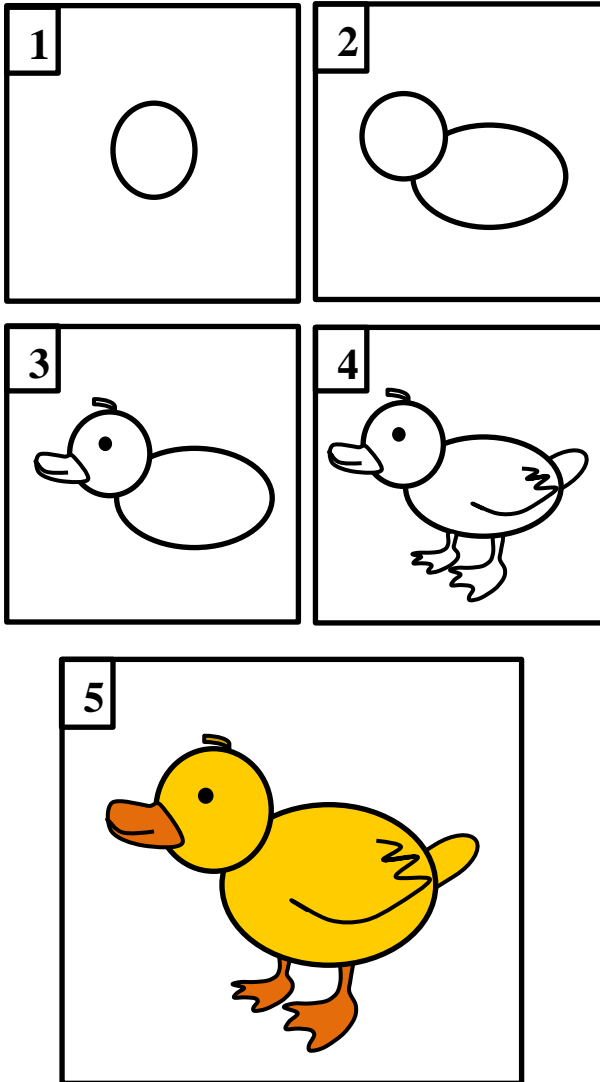

## WANE 5

### KÎSO

Kîso: Lawirekî ciyawaz e, ku dikare xwe di qalikê xwe de veşêre û xwe ji cemedê zivisatê biparêze.



## RAHÊNAN

li gor van gavên li jêr, kîsoyekî li ser lênûsa  
wênesaziyê xêz bike û bi rengê kesk rengîn bike.

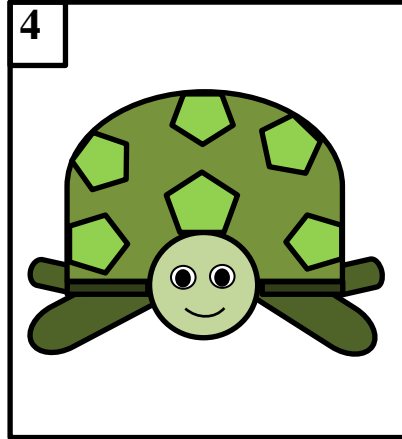
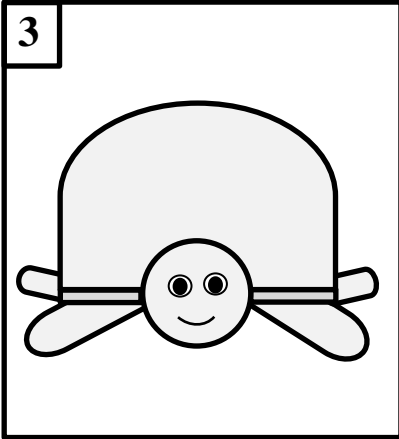
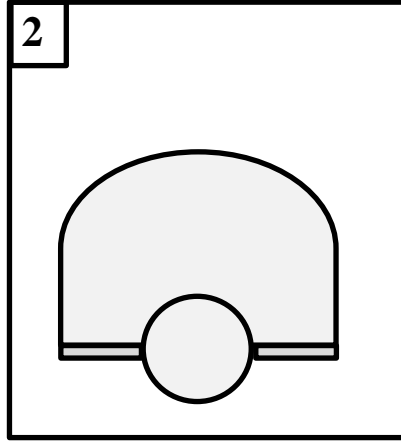
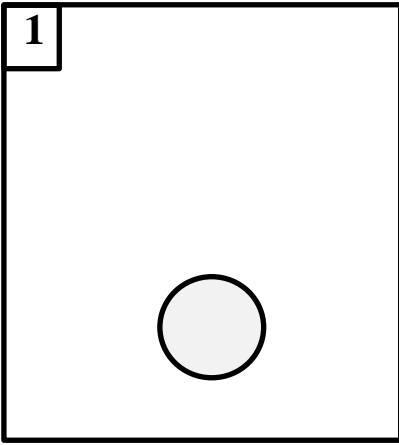



## WANE 6

### Pinpinîk

Pinpinîk, cureyek ji kêzikan e, ku bi rengên xwe yê cihêreng tê naskirin.

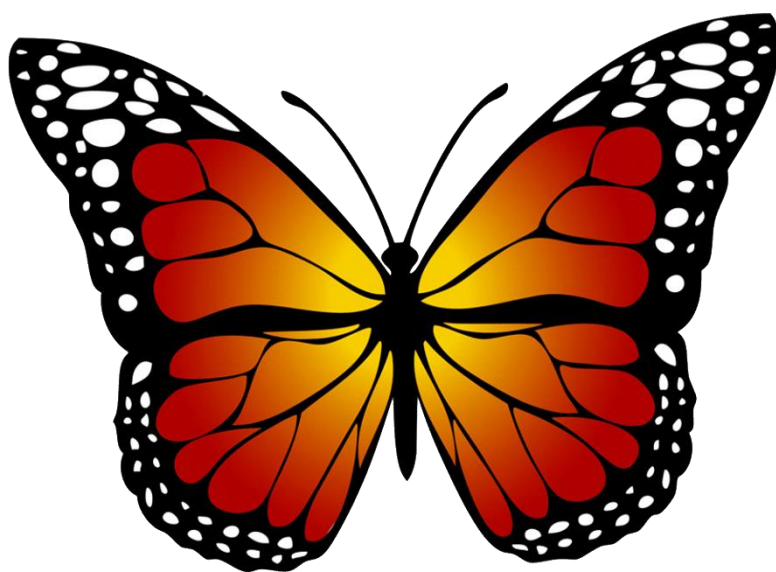

## RAHÊNAN

Ka em bi hev re pinpinêkekê li gor gavên li jêr, li ser lênûsa wênesaziyê saz û rengîn bikin.

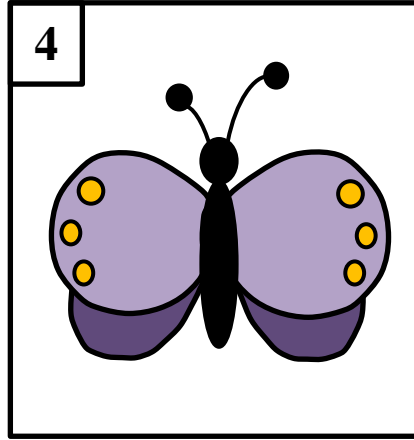
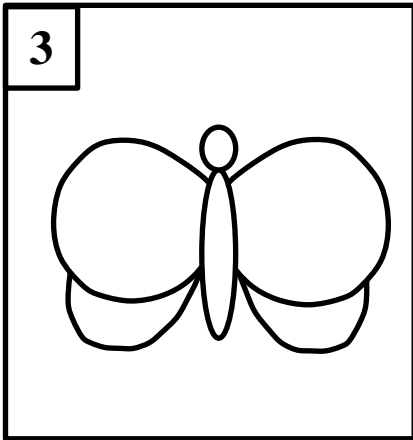
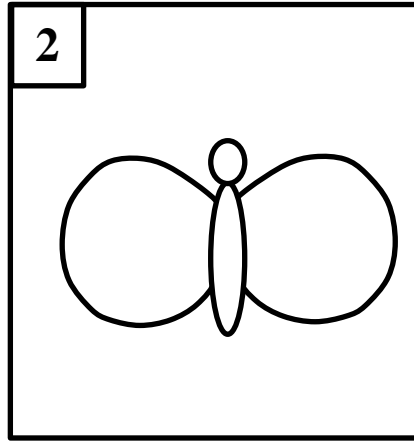
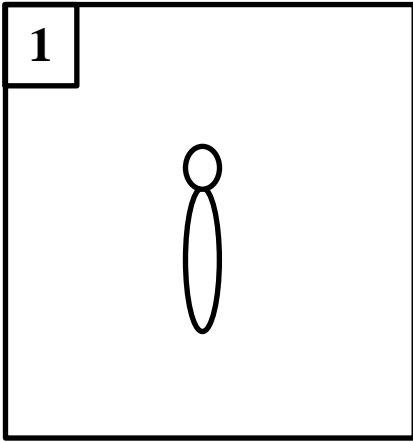

## WANE 7

### XALXALOK

Di vê waneyê de, em ê fêrî nîgarkirina xalxalokê bibin.



## RAHÊNAN

Nîgarkêşê jîr, li gor van gavên li jêr, xalxalokekê li ser lînûsa wênesaziyê xêz bike û paşê rengîn bike.

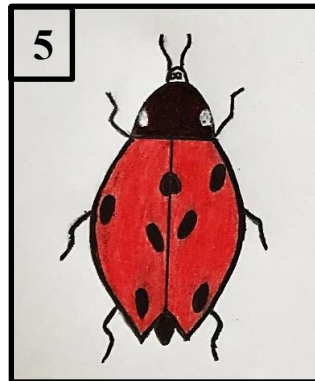
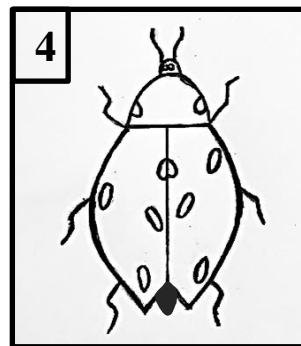
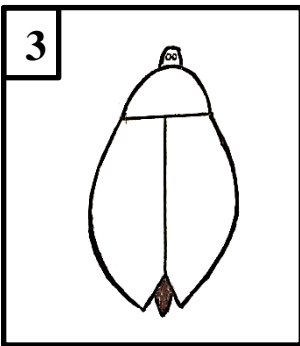
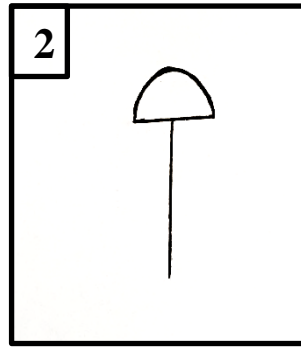
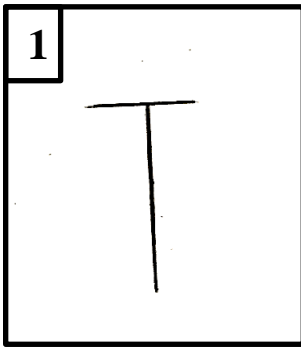

## WANE 8

### Simbil

Welatê me bi simbilên zêrîn, zengîn e.



## RAHÊNAN

Wênesazê zîrek, ka em gav bi gav, simbilekî li ser lênûsa wênesaziyê nîgar û rengîn bikin.

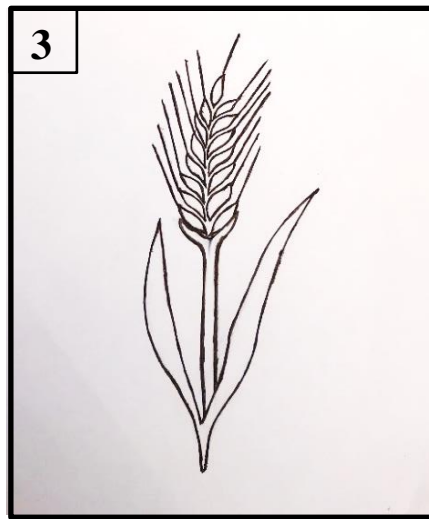
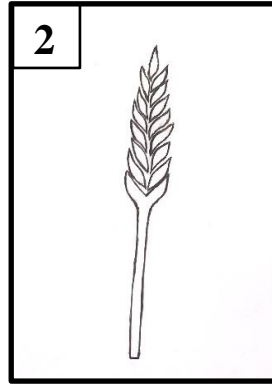
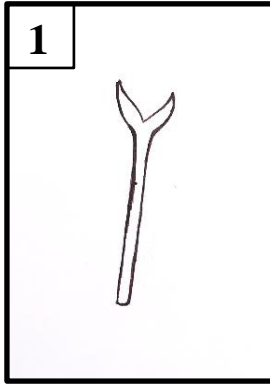

## WANE 9

### DAR

Dar; xwedî berhem û xweşikbûnekê ye. Ka em fêrî nîgarkirina wê bibin.

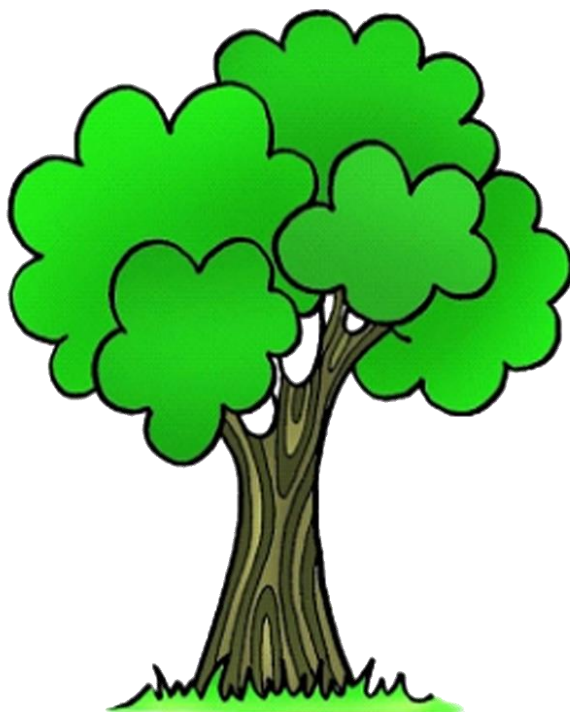

## RAHÊNAN

Ka em bi hev re, li gorî gavên li jêr, darekê li ser lînûsa wênesaziyê saz û rengîn bikin.

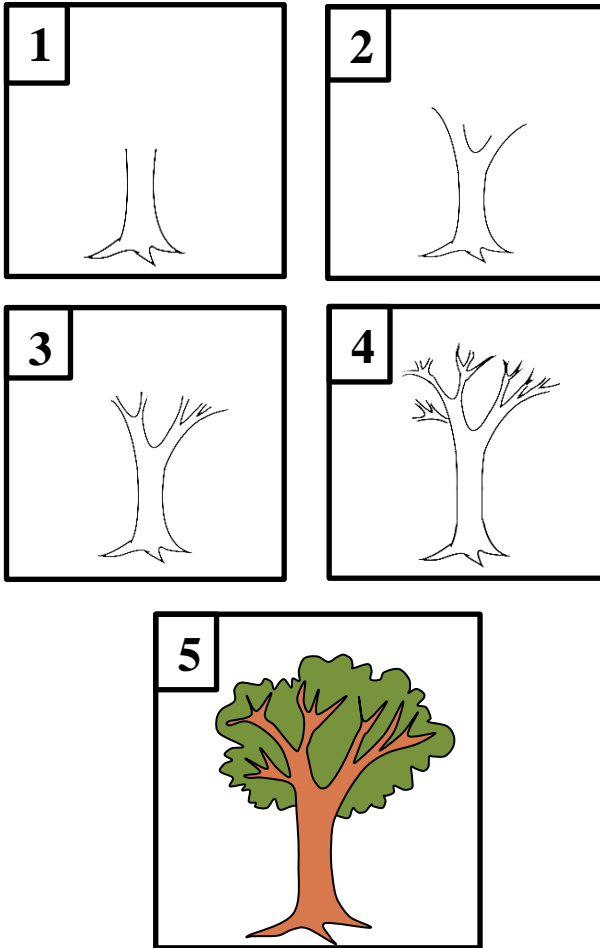



## WANE 10

### JI ÇARGOŞEYÊ ÇÊKIRINA RÛYEKÎ

Ji çargoşeyê, em dikarin rûyekî çêbikin.

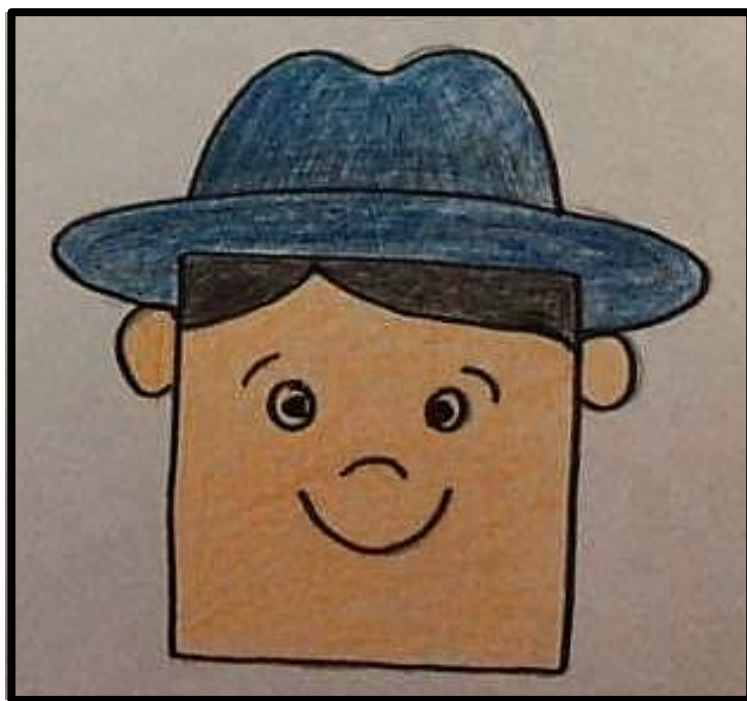

## RAHÊNAN

Em ê li gor van gavên li jêr, ji çargoşeyê rûyekî saz bikin.

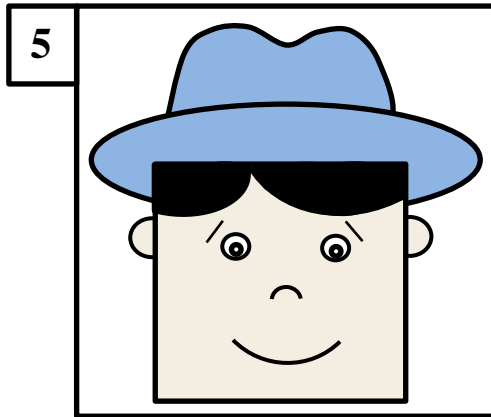
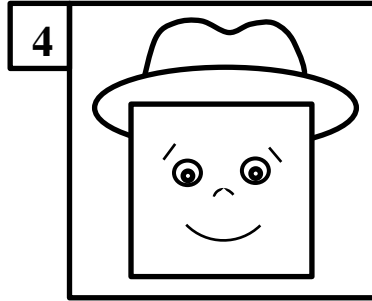
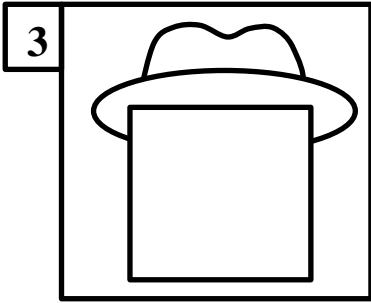
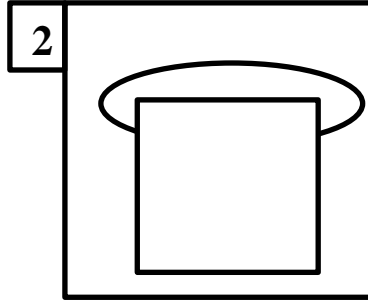
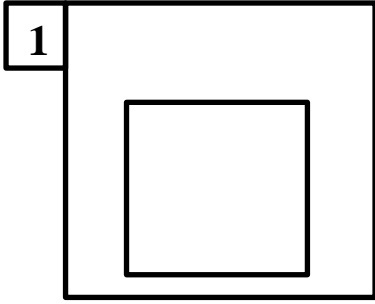

## WANE 11

### SOBE

Sobe; me ji sermaye zivistanê diparêze.



## RAHÊNAN

Nîgarkêşê jîr, li vî teşeyê li jêr binêre û paşê sobeyekê li ser lênûsa wênesaziyê xêz bike û bi rengên guncaw rengîn bike.

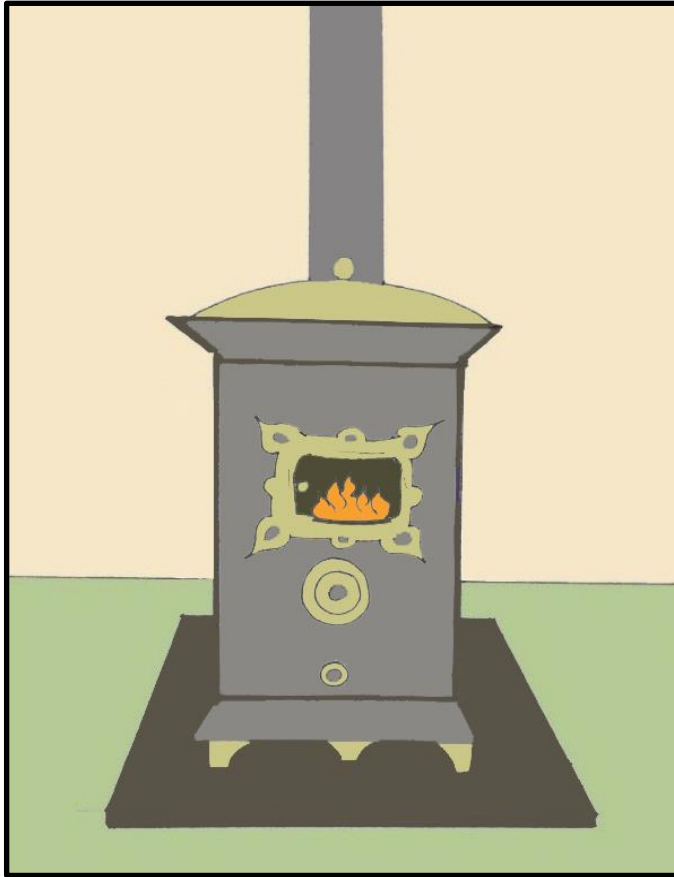

## WANE 12

### MÊZE Û RÛNIŞTEK

Di vê waneyê de, em ê hin raxeyên (pêdiviyên malê) malê nas bikin û fêrî xêzkirina wan bibin.



## RAHÊNAN

Em ê niha mêze û rûniştekekê li ser lênûsa wênesaziyê xêz bikin.

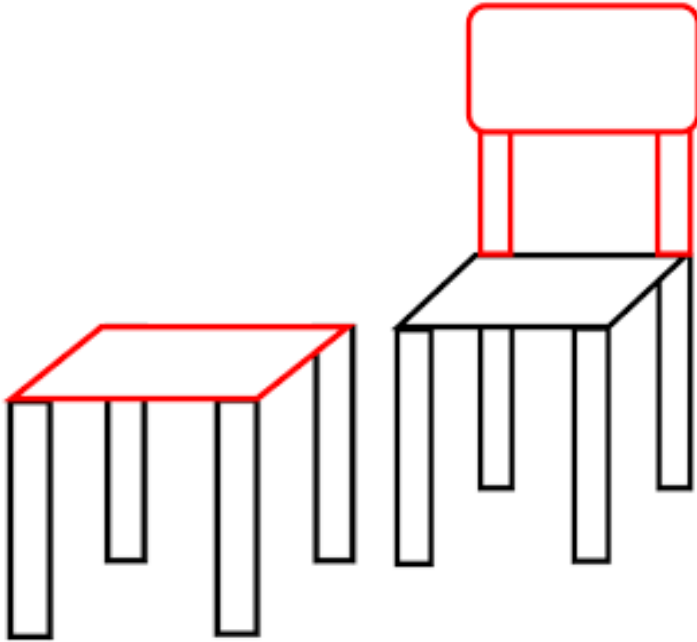

## WANE 13

### GULDANK

Guldank; ji bo xemilandina malan tê bikaranîn.



## RAHÊNAN

Hewil bide ku tu guldankekê li ser lînûsa wênesaziyê  
xêz bikî û paşê bi rengên cuda rengîn bikî.





## WANE 14

### DEMJIMÊR

Ji bo ku em dema xwe nas bikin û bi rêkûpêk bikin, demjimêr pêwîst e.



## RAHÊNAN

Ka em bi hev re, demjimêrekê mîna vê li ser lînûsa wênesaziyê xêz û rengîn bikin.



## WANE 15

### LÎSTINA BI HEVALAN RE

Dema em bi hevalên xwe re, dilîzin. Ew dem zû  
û xweş derbas dibe.

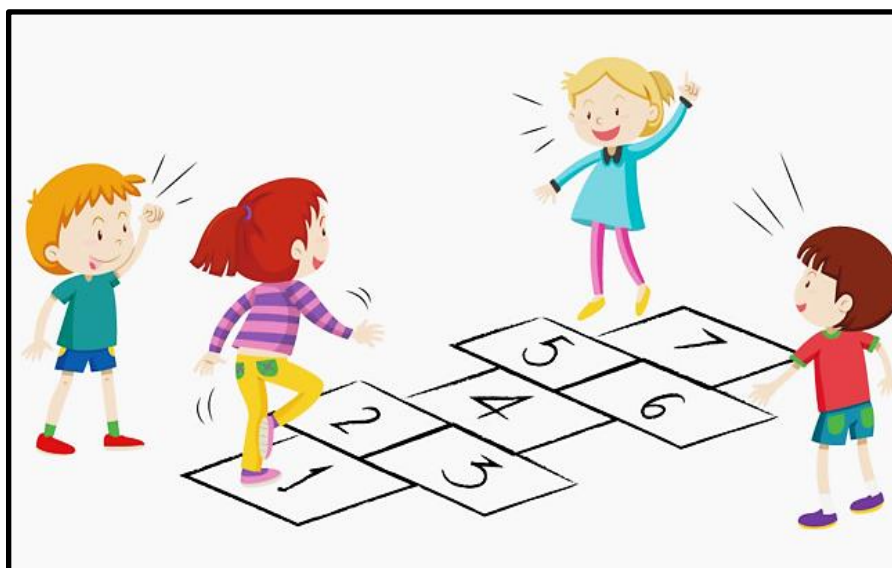

## RAHÊNAN

Wênesazê behremend, li teşeyê li jêr binêre û paşê  
lîskeke ku tu dixwazî bi hevalên xwe re bilîzî, nîgar  
bike.



## WANE 16

### PAQIJÎ

Paqijî, ji bo tendirûstiya me û xweşikbûna derdorê,  
pêwîst e.



## RAHÊNAN

Li teşeyê li jêr binêre, paşê teşeyekî nêzî wî li ser lênûsa wênesaziyê xêz û rengîn bike.



## WANE 17

### SEBZE

Gelek cureyên sebzeyan hene. Sebze, ji bo avakirina laşê me xwedî giringiyeke pir mezin in.

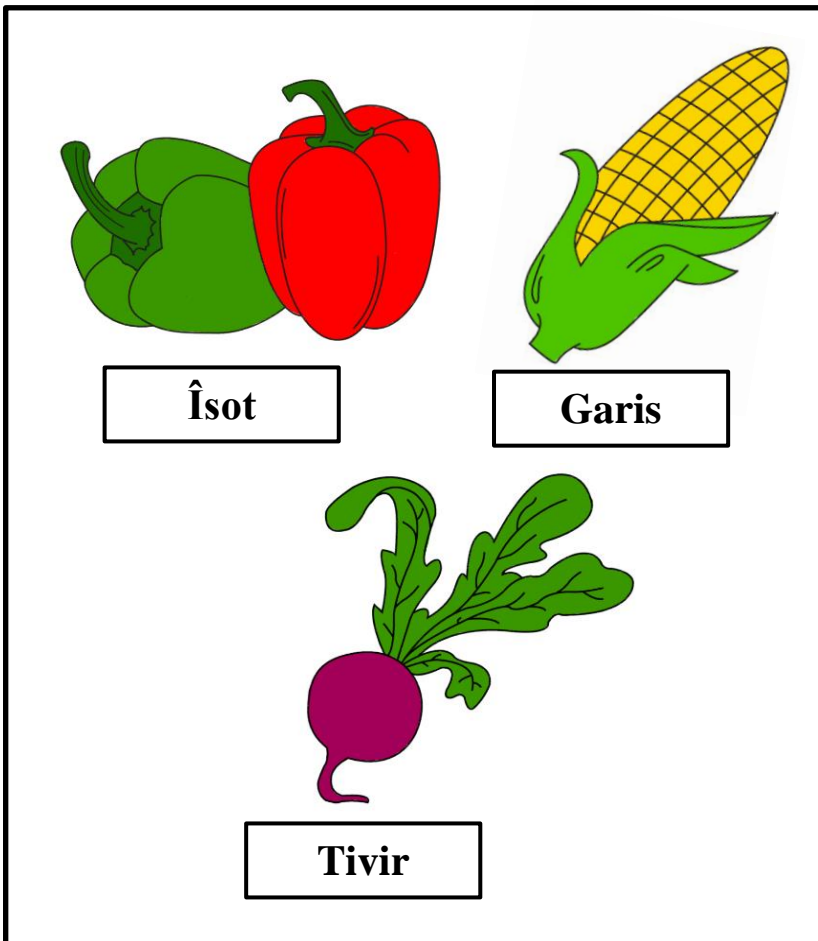

## RAHÊNAN

Wênesazê zîrek, li van teşeyên li jêr binêre û paşê hin sebzeyên ku tu jê hez dikî li ser lênûnsa wênesaziyê xêz û rengîn bike.

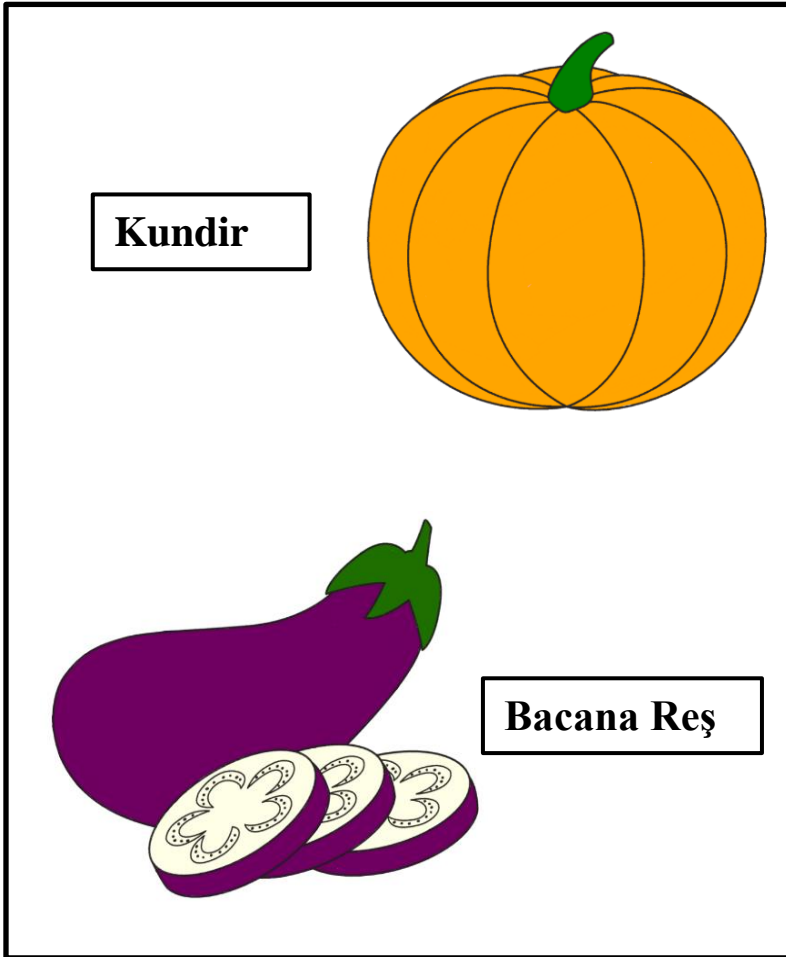



**WANE 18**

## **ROHILATIN**

Bi rohilatê re, rojeke nû dest pê dike.



## RAHÊNAN

Wênesazê biçûk, li teşeyê li jêr baş binêre û paşê  
teşeyekî nêzî wî, li ser lênûsa wênesaziyê nîgar û  
rengîn bike.



## WANE 19

# MÛMEK JI KOLACÊ

### Amûrên Pêwîst:

Kaxezên kolacê, pêûsa risas, jêbir û cawbir.

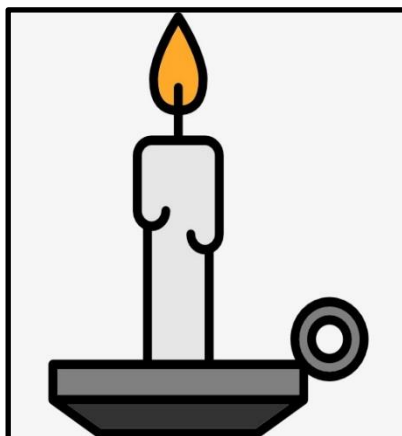

## RAHÊNAN

Ka em bi hev re li gor van gavên li jêr, mûmekê ji kolacê li ser lênûsa wênesaziyê saz bikin.

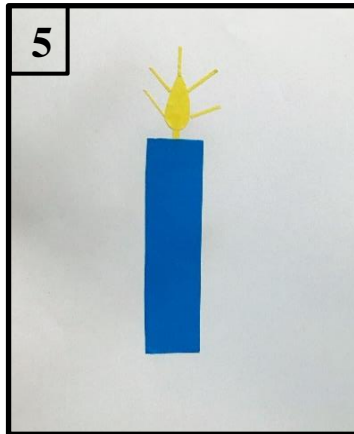
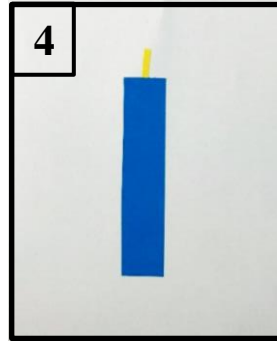
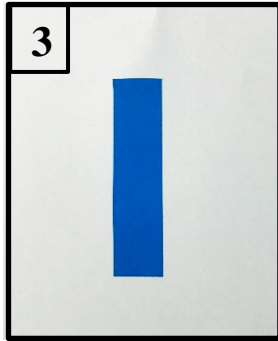
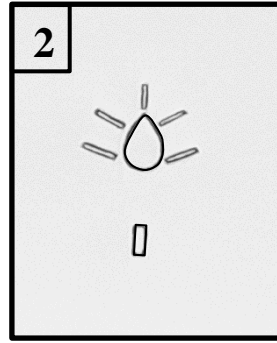
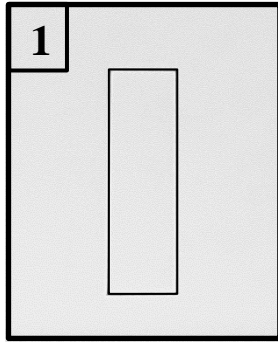

## WANE 20

### GULEK JI KOLACÊ

#### Amûrên Pêwîst:

Kaxezên kolacê, pêûsa risas, jêbir û cawbir.



## RAHÊNAN

Em ê niha li gor van gavên li jêr, gulekê ji kolacê li ser lînûsa wênesaziyê, çêbikin.

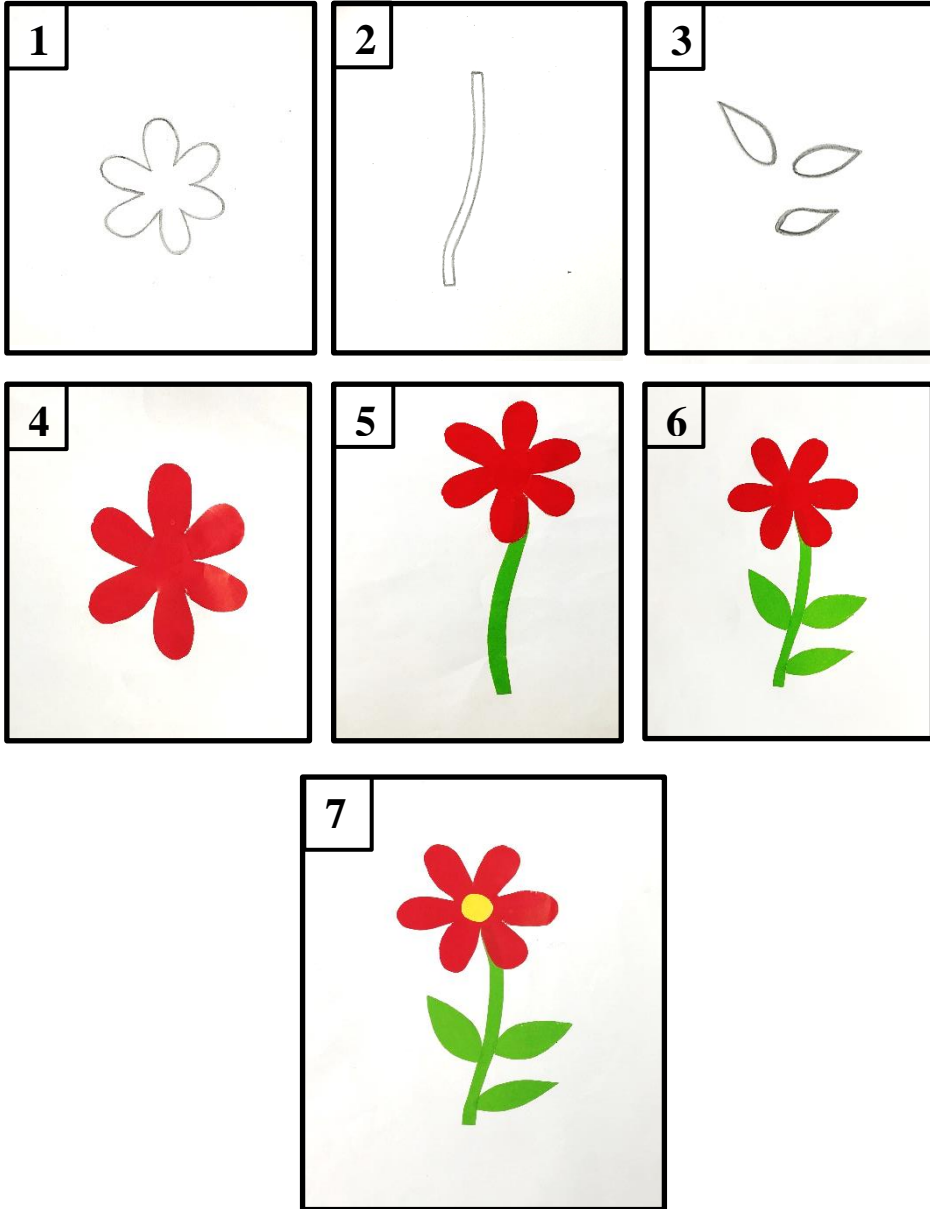

## Belavkirina Waneyan Li Ser Sala Xwendinê

Heftî Meh	Heftiya Yekem	Heftiya Duyem	Heftiya Sêyem	Heftiya Çarem
<b>Rezber</b>			Tevlihev- kirina rengan	Tevlihev- kirina rengan
COTMEH	Teşeyên Geometrîk	Teşeyên Geometrîk	Rêbazê Rengînki- rinê	Rêbazê Rengînki- rinê
MIJDAR	Werdek	Kîso	Kîso	Pinpinîk
RÊBENDAN	Xalxalok	Simbil	Dar	Dar
BERFANBAR	Sobe	<b>Lêveger</b>	<b>Bêhinve- dan</b>	<b>Bêhinve- dan</b>
REŞMEH	Mêze û Rûniştekan	Mêze û Rûniştekan	Guldank	Demjimêr
AVDAR	Lîstina bi Hevalan re	Lîstina bi Hevalan re	Paqijî	Sebze
COTAN	Rohilatin	Mûmek ji kolacê	Mûmek ji kolacê	Gulek ji kolacê
GULAN	Gulek ji kolacê	<b>Lêveger</b>		