



Operation IRAQI FREEDOM

Decisive War, Elusive Peace

Walter L. Perry • Richard E. Darilek • Laurinda L. Rohn • Jerry M. Sollinger
Editors

RAND
CORPORATION

For more information on this publication, visit www.rand.org/rr1214

Library of Congress Cataloging-in-Publication Data is available for this publication.

ISBN 978-0-8330-4192-0

Published by the RAND Corporation, Santa Monica, Calif.

© Copyright 2015 RAND Corporation

RAND® is a registered trademark.

Cover photo at top: Sergei Grits/AP Images; cover photo at bottom: Muhammed Muheisen/AP Images

Limited Print and Electronic Distribution Rights

This document and trademark(s) contained herein are protected by law. This representation of RAND intellectual property is provided for noncommercial use only. Unauthorized posting of this publication online is prohibited. Permission is given to duplicate this document for personal use only, as long as it is unaltered and complete. Permission is required from RAND to reproduce, or reuse in another form, any of its research documents for commercial use. For information on reprint and linking permissions, please visit www.rand.org/pubs/permissions.html.

The RAND Corporation is a research organization that develops solutions to public policy challenges to help make communities throughout the world safer and more secure, healthier and more prosperous. RAND is nonprofit, nonpartisan, and committed to the public interest.

RAND's publications do not necessarily reflect the opinions of its research clients and sponsors.

Support RAND

Make a tax-deductible charitable contribution at
www.rand.org/giving/contribute

www.rand.org

This work is dedicated to the memories of two of our friends and colleagues:

*John Y. Schrader
1940–2005*

and

*Nikki J. Shacklett
1953–2013*

Preface

Soon after Operation IRAQI FREEDOM (OIF) began in March 2003, RAND Arroyo Center began a research project at the request of the U.S. Army. This project set out to prepare an authoritative account of the planning and execution of combat and stability operations in Iraq and to identify key issues that could affect Army plans and goals, operational concepts, doctrine, and other Title 10 responsibilities.

The resulting body of work will interest those involved in organizing, training, and equipping military forces to plan for, deploy to, participate in, and support joint and multinational operations. Although focused primarily on Army forces and activities, the analysis also describes other aspects of joint and multinational operations. RAND analysts collected the information in these volumes from many sources, including unit after-action reports, compilations of lessons learned, official databases, media reports, other contemporary records, and interviews with key participants in OIF.

This report, which is based on unclassified source material only, presents a summary of a larger, five-volume study on OIF that drew from both classified and unclassified sources. It traces the operation from its root causes in the first Gulf War through operations up to approximately the end of June 2004. It addresses strategy, planning, and organization for OIF; examines air and ground force operations; reports on personnel, deployment, and logistics issues; describes coalition operations; discusses the occupation that followed combat operations; and considers civil-military operations. The analysis is based on reviews of contemporary records and interviews with key participants in OIF. The research was completed in October 2004 and the final draft was submitted in January 2006. Also, since the research was completed and recommendations formulated several years ago, the situation is likely to have changed. Some recommendations might already have been implemented in whole or in part.

The purpose of this analysis is to find out where problems occurred and to suggest possibilities to improve planning and operations in the future. The results of such analysis can seem therefore to be overly focused on the negative. This should not be taken to mean that no good was done. In fact, dedicated U.S. and coalition personnel, both military and civilian, engaged in many positive and constructive activities, individually and collectively. That this analysis does not highlight all those activities

should not in any way detract from their value. Our focus, however, remains on finding ways to improve.

This research was co-sponsored by the Deputy Chief of Staff, G-3, U.S. Army, and the Deputy Chief of Staff, G-8, U.S. Army. It was conducted in RAND Arroyo Center's Strategy, Doctrine, and Resources Program. RAND Arroyo Center, part of the RAND Corporation, is a federally funded research and development center sponsored by the United States Army.

For more information on RAND Arroyo Center, contact the Director of Operations (telephone 310-393-0411, extension 6419; FAX 310-451-6952; email Marcy_Agmon@rand.org), or visit Arroyo's website at <http://www.rand.org/ard.html>.

The Project Unique Identification Code (PUIC) for the project that produced this document is DAMOAX003.

Contents

Preface	v
Figures	xv
Tables	xvii
Summary	xix
Acknowledgments	xxxiii
Acronyms	xxxv

CHAPTER ONE

Introduction	1
Sources of Our Data	2
Timeline and Reference Map	2
How the Book Is Organized	8

CHAPTER TWO

Genesis of the War

<i>Jefferson P. Marquis, Walter L. Perry, Andrea Mejia, Jerry M. Sollinger, Vipin Narang</i> ...	9
Political Underpinnings	9
Aftermath of the First Gulf War	10
Uprisings	12
Military Reorganization and Growth of Saddam's Security Forces	14
U.S. Regional Footprint Grows After First Gulf War	16
A Decade of Containment and Regime Change, 1991 to 2001	19
Containment: The UN Resolutions	19
Regime Change	22
The Global War on Terrorism	28

CHAPTER THREE

Planning the War and the Transition to Peace

<i>Walter L. Perry</i>	31
The Warplan Evolves	31
Minimizing Collateral Damage	32

Lines and Slices	32
A Generated or Running Start?	34
Weapons of Mass Destruction	35
Emergence of the Hybrid Plan	37
Planning for the Aftermath	38
A Late Start at CENTCOM	40
CFLCC Planning for Post-Hostility Operations	42
Task Force IV	43
Planning	44
Operational Challenges	46
The Dissolution of Task Force IV	46
A Plan Without Resources	47
Planting the Seeds of Failure	49
Implications for Planning Policy	52
Summing Up the Planning Process for Iraq	55
Getting the Force Size Right	56
Inverted Planning	56

CHAPTER FOUR

Land Operations

<i>Bruce R. Pirnie, John Gordon IV, Richard R. Brennan, Jr., Forrest E. Morgan,</i> <i>Alexander C. Hou, Chad Yost, Andrea Mejia, David E. Mosher.</i>	57
Overview	58
The War Begins	58
Overview	60
Lines of Communication	61
Outflanking Iraqi Forces	61
Combat Phases	61
Combat Phase 1: Rapid Advance (March 19–25)	64
Combat Phase 2: Consolidation and Buildup (March 26–31)	85
Combat Phase 3: Seizure of Baghdad (April 1–14)	86
Special Operations	102
Creation of a Joint Special Operations Task Force	105
Joint Special Operations Task Force–North	106
Joint Special Operations Task Force–West	123
Naval Special Warfare Task Group Central (TG-Cent)	124
Task Force 20 (TF-20)	124
The WMD Campaign	126
Planning and Preparation	127
Planning at CENTCOM	127
Creating the Exploitation Task Force (XTF)	129
A Brief History of the 75th XTF in Iraq	133

Challenges on the Ground	138
Observations and Lessons.....	145
Concluding Remarks	147

CHAPTER FIVE

Air Operations

<i>Bruce R. Pirnie, John Gordon IV, Richard R. Brennan, Jr., Forrest E. Morgan,</i> <i>Alexander C. Hou, Chad Yost</i>	149
Air Attacks	151
Precision Strike Dominates the Air Campaign.....	155
Air Attacks on Iraqi Ground Forces	158
Regional Air Campaigns.....	159
The Joint Tactical Information Distribution System (JTIDS)	161
Marine Corps Air	161
Control Measures	162
The Fire Support Coordination Line (FSCL).....	163
Killboxes	163
The Marine Corps's Direct Air Support Center (DASC)	164
Coordination of Joint Fires	164
3rd Infantry Division Supporting Fires	164
V Corps Supporting Fires.....	165
I MEF Supporting Fires.....	167
The DASC Versus the ASOC	168
The Air Tasking Order	170
Refining Coordination Measures	172
Defense Against Ballistic and Cruise Missiles.....	174
Patriot Forces Organization	174
Planning and Preparation.....	175
Regional Air Defense.....	175
Defense Against Ballistic Missiles	176
The Challenge of Cruise Missiles	179
Issues in Air Defense	179

CHAPTER SIX

Why the Iraqi Resistance Was So Weak

<i>Stephen T. Hosmer.....</i>	183
The Weak Iraqi Resistance.....	183
The Iraqi Failure to Exploit More Effective Defensive Options	184
Sources	185
Themes of the Chapter	186
Saddam's Strategic Miscalculations.....	186
Saddam's Flawed Decisionmaking	188

Saddam’s Strategic Miscalculations in 2003.....	192
The Consequences of Saddam’s Strategic Misjudgments.....	198
Saddam’s Internal Security Concerns Weakened Iraqi Defenses Against External Attack.....	199
Iraq’s Forces Were Shaped to Forestall Coups, Uprisings.....	200
Iraqi Military Strategy and Operations Were Poorly Designed and Executed.....	202
Poor Motivation and Morale Decisively Undermined the Iraqi Defense.....	217
Superior Military Capabilities Gave Coalition Forces an Overwhelming Advantage.....	231
Concluding Observations.....	234
The Coalition’s Victory Was Achieved Rapidly and at a Low Cost.....	234
Decisionmakers Should Be Careful About the Lessons They Draw from OIF.....	235
OIF and Its Immediate Aftermath Paved the Way for the Insurgency That Followed... ..	236
U.S. Assumptions and Actions Also Fueled the Insurgency.....	238
How OIF May Influence the Behavior of Future U.S. Adversaries.....	241

CHAPTER SEVEN

Managing the War

<i>Walter L. Perry, Edward O’Connell, Miranda Priebe, Alexander C. Hou,</i> <i>Lowell H. Schwartz.....</i>	245
The Lessons of Afghanistan.....	245
Implications for Operation IRAQI FREEDOM.....	247
Command and Control.....	248
Command and Control of Land Forces.....	252
Command and Control of V Corps Units.....	252
Command and Control of Marine Corps Units.....	253
The UK’s 1 Armoured Division.....	255
Command and Control of Air Forces.....	255
Controlling Air Operations.....	256
Controlling the Targeting Process.....	257
Coordinating with the CIA.....	259
Communicating with the Force.....	260
Blue Force Tracker.....	260
Tactical Satellite and Terrestrial Systems.....	261
Situational Awareness.....	262
Collection.....	263
The Role of UAVs.....	263
Fixed-Wing Reconnaissance.....	267
Organic Collection Capabilities.....	268
Sensor Integration.....	269
Intelligence.....	270
Intelligence Preparation of the Battlefield (IPB).....	270

Intelligence Operations at CFLCC	273
Dissemination	274
Dissemination on the Move	274
The Common Operational Picture	275
The Situational Awareness Lessons	278
Space Operations	279
Organization and the Command and Control of Space Forces	279
Space Contributions	280
Satellite Communications	281
Positioning, Velocity, Navigation, and Timing (PVNT)	281
Missile Detection and Warning	285
Army Space Support to OIF	285
Battle Damage Assessment	288
What Is BDA?	288
The BDA Process in OIF	289
Split Operations	289
The Process Comes Unhinged	290
Information Operations	292
Changing Perspective	293
The Plan	294
Pre-Combat Operations	294
Support to the Major Combat Operations	296
Did IO Have an Effect?	298
Developing Measures	299
Moving IO into the Mainstream	300
Media Coverage	302
The Warplan	303
Planning	305
Operations	309
The CENTCOM Briefings	312
Effectiveness of the Embedded Press System	313
Effects on Ground Units	314

CHAPTER EIGHT

The Aftermath: Civilian Planning Efforts and the Occupation of Iraq

<i>Nora Bensahel, Olga Oliker, Keith Crane, Heather S. Gregg,</i> <i>Richard R. Brennan, Jr., Andrew Rathmell</i>	319
Interagency Coordination	320
National Security Council	321
Office of the Secretary of Defense	322
The State Department	325

U.S. Agency for International Development 327
 The Office of Reconstruction and Humanitarian Assistance 328
 Humanitarian Planning 330
 The Occupation of Iraq 330
 Governance Structures: CPA and Iraqi Institutions 332
 Security Forces and Institutions 334
 Economic Policy and Reconstruction 336
 Assessing Postwar Efforts 338

CHAPTER NINE

Mobilization, Deployment, and Sustainment in Operation IRAQI FREEDOM

*Eric Peltz, Dave Kassing, Chad Yost, Marc Robbins, Kenneth Girardini,
 Brian Nichiporuk, Peter Schirmer, John M. Halliday, John R. Bondanella* 341
 Mobilization 341
 Recommendations to Improve Mobilization Capability 342
 Deployment 343
 Sustainment 344
 Resupply During Combat Operations 345
 The Pause in the Advance at Objective RAMS 350
 Supply Chain Performance in Operation IRAQI FREEDOM 353
 Tactical Supply Operations 354
 Tactical Supply Operations in OIF 356
 Theater Distribution 360
 Theater Distribution in OIF 361
 Strategic Distribution 364
 Strategic Distribution in OIF 365
 National Supply Management 369
 National Supply Management in OIF 370
 Command and Control 370
 Command and Control in OIF 371
 Concluding Observations on Sustainment in OIF 371

CHAPTER TEN

Conclusions and Recommendations 373
 Planning 373
 Planning for Post-Conflict 375
 Land Forces 376
 Close Air Support 378
 Rotary-Wing Operations 379
 Fire Support Control Measures 380
 Integration of SOF with Conventional Forces 381

Controlling the Force..... 382

Situational Awareness..... 383

Space Operations..... 386

Battle Damage Assessment..... 388

Information Operations..... 390

Media Coverage..... 391

Mobilization..... 392

Sustainment..... 393

Bibliography..... 399

Figures

S.1.	Overview of Operation IRAQI FREEDOM, March 19 to April 14, 2003	xxii
1.1.	Chronology of Events Relating to Operation IRAQI FREEDOM	3
1.2.	Iraq	4
3.1.	Lines and Slices	33
3.2.	The Final Plan	39
3.3.	Military Presence at Outset of Post-Conflict Operations	53
4.1.	Overview of Operation IRAQI FREEDOM, March 19 to April 14, 2003	59
4.2.	Iraqi Road Net	62
4.3.	Flanking Iraqi Forces During Operation IRAQI FREEDOM	63
4.4.	Rapid Advance to An Najaf	66
4.5.	An Nasiriyah, Iraq	69
4.6.	The 507th Maintenance Company Travels Up and Down “Ambush Alley,” March 23, 2003	70
4.7.	The Battle for the Bridges: An Nasiriyah, March 23	72
4.8.	The Bridges of An Nasiriyah	74
4.9.	Company C, 1-2 Marines at the Saddam Canal	76
4.10.	11th Attack Helicopter Regiment Attack Route to Medina Division	82
4.11.	The Battle at Objective PEACH	88
4.12.	Crossing the Euphrates at Objective PEACH	89
4.13.	Seizure of Baghdad	101
4.14.	Occupation of Iraq	103
4.15.	Organization of Special Operations Forces in Operation IRAQI FREEDOM	105
4.16.	Kurdish Inhabited Area	107
4.17.	Political Boundaries of Northern Iraq	109
4.18.	Colonel Cleveland with Tribal Leaders in Mosul	119
4.19.	Sample Leaflet Designed to Discourage WMD Use	129
4.20.	SST Organization	131
5.1.	Killbox Concept	159
5.2.	Control Arrangements During Operation IRAQI FREEDOM	169
7.1.	National and Component Command and Control	249
7.2.	Command and Control of V Corps Units	253
7.3.	Command and Control of Marine Corps Units	254

7.4.	Air Forces Control Structure	256
7.5.	Blue Force Tracker Configurations in Operation IRAQI FREEDOM	261
7.6.	Principal UAVs Used in Operation IRAQI FREEDOM	265
7.7.	The Common Operational Picture for April 9, 2003	276
7.8.	Satellite Communications Supporting CENTCOM in Four Operations	282
7.9.	Growth in Use of GPS-Guided Air Munitions	283
7.10.	Percentage of GPS-Guided Air Munitions as Compared to Non-GPS-Guided and Unguided Air Munitions Expended	284
7.11.	Coalition Capitulation and Desertion Messages	297
8.1.	Average Number of Daily Attacks by Insurgents in Iraq, June 2003 to June 2004	331
9.1.	Major V Corps Routes of Advance, Objectives, and Logistics Support Areas	351
9.2.	A Readiness Focused Supply Chain	354
9.3.	Inventory Performance for Major Army Units	357
9.4.	Maintenance Requests by 1st BCT, 3rd Infantry Division Units and 3rd Forward Support Battalion, 1st BCT, 3rd Infantry Division Requisitions	358
9.5.	Comparing Accommodation for the 203rd FSB's APS and Home Station ASLs	360
9.6.	Requisition Wait Time for Army Units in Operation IRAQI FREEDOM, Without Backorder Time	366
9.7.	Box (Multipack) and Pallet Configurations	367

Tables

3.1.	Comparing the Plans.....	38
5.1.	Combat Aircraft in Operation IRAQI FREEDOM	152
5.2.	Sorties Flown in Operation IRAQI FREEDOM.....	153
5.3.	The Air Campaign in Operation IRAQI FREEDOM.....	154
5.4.	Sorties Flown Against Target Categories in Operation DESERT STORM....	155
5.5.	Munitions Expended by Type.....	157
5.6.	Missile Defense During Operation IRAQI FREEDOM.....	178
6.1.	The Drop in Iraqi Military Capability, 1990–2002	216
7.1.	Organizations Participating in Operation IRAQI FREEDOM	246
7.2.	Air Expeditionary Force Composition for Operation IRAQI FREEDOM....	256
7.3.	Comparing UAVs Used in Operation IRAQI FREEDOM	264
7.4.	A Sample of Media Organizations Embedded	307
7.5.	Number of Reporters in Recent Operations	308
7.6.	Media Deaths from March 22 Through April 15, 2003	315
7.7.	U.S. Public Perception of Media Coverage	315
9.1.	Days of Supply On Hand, 1st BCT Orange 1 Reports	347
9.2.	Days of Supply On Hand as Reported in 3rd COSCOM Commander’s Daily Update Briefings.....	348

Summary

On March 19, 2003, coalition forces launched Operation IRAQI FREEDOM (OIF) to rid Iraq of its weapons of mass destruction, as well as to topple Saddam Hussein's regime and replace it with a democracy. As the title of this work suggests, the coalition achieved a decisive victory against Iraqi military forces, which led to the collapse of Saddam's regime, but it struggled subsequently to secure the peace. This monograph provides a historical account of OIF from its roots in the 1990s and of postwar activities through the end of June 2004. As this timing would suggest, the combat phase receives more treatment than does the period after major combat. Along the way, the document offers a number of observations about different aspects of the war and its aftermath, raises several major questions (featured below) about both, and concludes with a series of recommendations.

Genesis: Was OIF Inevitable?

No, but it was predictable, almost as soon as the first Gulf War ended with Saddam's regime largely intact. Wars do not occur spontaneously. Even when precipitated by a sudden event—such as the invasion of Kuwait or the attack on Pearl Harbor—they typically have their roots in events that occurred years or decades before the fighting begins. War in Iraq is no exception. As was the case with World War II, the seeds of the second Gulf War were sown in the first. But the picture is more complex than that. A decade of efforts to contain the regime of Saddam Hussein, although largely successful, produced a sense of frustration in the West over his seeming ability to thwart United Nations sanctions imposed on Iraq and retain his iron grip on that country. This was all compounded by the perception that Saddam Hussein was continuing to develop and stockpile weapons of mass destruction and by the events of 9/11.

Containment was always only one aspect of U.S. policy toward Iraq following Operation DESERT STORM. Regime change was the other part of the equation—endorsed by three U.S. presidents during the interwar years—and its importance increased relative to containment in the years before the second Gulf War. Although regime change did not become official government policy until 1998, the United States

was clearly interested in removing Saddam from power even before the first Gulf War ended. Over the course of twelve years, it supported a variety of attempts to remove Saddam, ranging from covert attempts at regime change to overt support of external opposition groups. However, all of these efforts to get rid of Saddam failed. The deciding factor was the terrorist attacks in the United States on September 11, 2001. These hardened U.S. resolve to oust Saddam Hussein, and that resolve led directly to OIF in 2003.

The United States had developed and enhanced a strong military coalition structure, as well as a robust infrastructure, in the Middle East following DESERT STORM. This buildup made it almost impossible for Saddam Hussein to contemplate military action outside Iraq's borders and greatly facilitated the U.S.-led offensive against Iraq in 2003. As a result of Operation SOUTHERN WATCH (OSW), as well as more limited U.S. and coalition military responses to Iraqi violations of UN agreements, the U.S. military presence in the Gulf region grew substantially in the early-to-mid 1990s. Although these forces consisted primarily of U.S. air and naval elements, the U.S. Army's contingency presence included several Patriot air defense batteries and a battalion task force that intermittently deployed to Kuwait for exercise INTRINSIC ACTION. In 1991, the United States also deployed forces to Iraq's northern flank in support of Operation NORTHERN WATCH. Conducted from Incirlik Air Base in southeast Turkey, NORTHERN WATCH was primarily a U.S. Air Force operation that gradually declined in size throughout much of the 1990s.

Although the United States withdrew its forces from Dhahran and Riyadh and consolidated them at Prince Sultan Air Base in Saudi Arabia, U.S. access to other states on the Arabian Peninsula—Kuwait, Bahrain, the United Arab Emirates, and Qatar—expanded as a result of the first Gulf War. This expansion of America's presence in the region indicated not only that the United States appeared to have learned lessons from the first Gulf War, but also that many Gulf States recognized and accepted the U.S. role as guardian of the region. For instance, U.S. Central Command (CENTCOM) established its forward headquarters in Kuwait at Camp Doha, where it prepositioned combat equipment for a heavy brigade. In addition, the expanded U.S. footprint in the Gulf enabled joint training between the United States and the Gulf States, improving readiness and capability for any planned military action in the region.

Planning: Why Was the Planning Process So Effective in Producing a Quick and Decisive Defeat of Iraqi Military Forces Yet So Ineffective in Preparing for Postwar Operations?

It was not a lack of planning for either combat (also called Phase III) or postwar (also called Phase IV) operations that led to the coalition's military forces—triumphant in all major combat operations—being unprepared for the immediate postwar chal-

lenges. Instead, problems arose from the failure of the planning process to identify resource requirements for the transition from combat to postcombat operations, as well as from the failure to challenge assumptions about what postwar Iraq would look like.

Prewar interagency planning and collaboration for the postwar lacked unity of effort and fell far short of what was necessary. The failures of the interagency process, however, do not explain why the military was ill prepared to respond to security concerns that arose in the immediate aftermath of major combat operations. The success of the ground campaign in OIF demonstrates the importance of military planning as an effective guide to how battles should be prosecuted and war fought. However, a preference for planning the major combat operations first and foremost, leaving stabilization efforts (some of which have to be undertaken during the war) to be planned afterward, leaves the military ill prepared to complete the overarching postwar task, namely, winning the peace—the ultimate object of war. Simply put, winning battles does not necessarily translate into winning wars. Missions, responsibilities, and resources need to be planned as thoroughly for the postcombat phases as they are for combat operations.

Most notable was the absence of any serious discussion of the size of the force required to secure the peace following major combat operations. General Tommy Franks, the CENTCOM commander, did mention at one point that he expected to have 250,000 troops in Iraq after major combat ended. However, these were the forces dedicated to the invasion and defeat of Saddam Hussein's forces, not necessarily the number and type of forces needed to secure the peace. Optimistic assumptions about how coalition forces would be greeted, the postwar viability of Iraqi institutions, and the continuing existence of the Iraqi army led planners to underestimate the number of coalition troops and the different kinds of effort (e.g., nation-building, counterinsurgency) needed to achieve peace.

The OIF experience, writ large, argues for a different kind of planning process. In the changed process, political-military endstates—as well as the military and civilian forces needed to achieve, maintain, and secure those endstates and, therewith, the peace—should be the primary focus of any operational plan from its inception. One implication of this conclusion is that the military may have to share the lead in operational planning with others. Another is that such planning should be embedded within an effective interagency process.

Decisive Victory: How Could Such a Small Coalition Force Achieve Such a Quick and Decisive Victory with So Few Casualties?

Iraq might have seemed formidable in 1990, but a decade later it presented a different picture. It had lost large amounts of military equipment that it could not replace due to sanctions imposed by the United Nations. It no longer exerted control over the Kurdish-inhabited north, where two Iraqi corps focused on defensive operations. Its

air force was decrepit, and its navy had practically ceased to exist. Simultaneously, the U.S. military steadily improved its capabilities over the interwar period. Not surprisingly, officials within the Department of Defense were willing to approve initiating operations in 2003 with far fewer forces than had seemed necessary in 1991.

Major combat operations in OIF began on March 19 and ended on April 14, 2003. In that short period, the entire Iraqi military structure collapsed in the face of far superior coalition forces. The Tigris-Euphrates Valley was the region of decisive operations to defeat Iraqi forces and to overthrow Saddam Hussein (see Figure S.1). In this region, Army and Marine Corps ground and air forces, in tandem with Air Force and Navy air forces, conducted a series of meeting engagements, often associated with key terrain, such as river crossings, road interchanges, and centers of government power.

The Army's 3rd Infantry Division (Mechanized) together with the 1st Marine Division advanced rapidly through Iraq on parallel axes, supported by Task Force Tarawa attacking on the eastern flank. They encountered strong resistance in only a few locations, especially An Nasiriyah, As Samawah, and An Najaf. In six days, they had advanced to An Najaf and to just south of Ad Diwaniyah. Then, an intense sandstorm followed by driving rain severely impeded mobility and largely grounded helicopters, although fixed-wing aircraft continued to attack important targets. Facing the difficulty of supplying his forces over long lines of communications, Lieutenant General William Wallace, the V Corps commander in charge of Army units advancing toward Baghdad on the western side of the Euphrates River, decided to pause the advance while building up supplies for decisive operations against Baghdad. The advance resumed on March 30, and by April 10 major combat had come to an end in Baghdad. Four days later, encountering less opposition than expected, Task Force Tripoli secured Saddam Hussein's hometown of Tikrit.

The U.S. strategy had been to advance quickly to Baghdad, bypassing all other cities as much as possible. CENTCOM planners had recognized that occupying urban areas could absorb more forces than they had available. Indeed, CENTCOM ultimately committed most of its operational reserve (101st Airborne Division, elements of the 82nd Airborne Division, and Task Force Tarawa) to urban operations intended to secure long, vulnerable lines of communication. The British contingent, built around the 1 UK Armoured Division, focused on southern Iraq while the U.S. force advanced northward. When urban combat occurred, it strongly resembled combat elsewhere during the advance: violent but usually brief meeting engagements.

The story of this decisive victory includes operations on land by Army, Marine Corps, special operations, and British forces, as well as in the air, where U.S. Air Force, Marine Corps, Navy, Army, and coalition pilots held sway. Several important battles took place, although these were few in number given the collapse of Iraqi forces. Nevertheless, the engagements that did take place revealed both vulnerabilities and strengths of coalition forces; these engagements included: (1) the failed attack of the Army's 11th Attack Helicopter Regiment on March 23, (2) Task Force Tarawa's battle

in An Nasiriyah on March 23–24, (3) the seizure and subsequent defense by 1st Brigade, 3rd Infantry Division of the bridgehead over the Euphrates River south of Baghdad at Objective PEACH on April 2–3, (4) the April 5 “Thunder Run” by Task Force 1-64 Armor of the 2nd Brigade of 3rd Infantry Division, and (5) the April 10 attack into northeast Baghdad by 1st Battalion, 5th Marines.

Coalition air forces struck Iraqi land forces located in the path of advancing Army, Marine Corps, and other coalition units. Air forces also provided coalition ground forces with some otherwise-hard-to-come-by reconnaissance information. Close air support was a prominent mission for U.S. and coalition aircraft in this campaign. It was extremely effective, not only in conjunction with other fire support assets but also on its own. Fire support coordination measures employed in OIF, however, proved to be more problematic. On balance, coalition air and ground forces worked together in OIF better than they ever had before.

Overall, U.S. forces enjoyed crushing superiority. That said, U.S. land forces were surprisingly small, amounting for the most part to just two divisions (3rd Infantry Division (Mechanized) and 1st Marine Division). These relatively small forces had enough strength to topple the regime, but they would likely have been more stressed

Figure S.1
Overview of Operation IRAQI FREEDOM, March 19 to April 14, 2003



had the Iraqis offered greater resistance. Moreover, they lacked enough light infantry forces to impose order when the regime fell.

The Enemy: Why Was Iraqi Resistance to the Coalition Invasion So Weak?

The defense that Iraqis mounted against the coalition's attack on March 19, 2003, was surprisingly vulnerable and extraordinarily weak. During OIF, Iraq deployed its forces largely against the Kurds and on the Iranian border, not along invasion corridors through the Tigris-Euphrates Valley. Iraqi forces consisted of a mixture of Special Republican Guards, Republican Guards, regular army, Ba'athist militia, and Fedayeen Saddam that appeared to lack central direction. They delivered intense but poorly aimed fire and conducted headlong assaults, often senselessly repeated despite huge losses. The Iraqi regime tried to pursue guerrilla warfare during the invasion but lacked the popular support essential for success. Most Iraqi forces, particularly the regular army, chose not to fight, but those that did fight often displayed reckless courage.

Although the defeat of the Iraqi army surprised no one, the speed of its collapse did. Even though the Iraqi army was in decidedly worse shape than it was at the outset of the first Gulf War, it still had, on paper at least, forces endowed with enough capability to mount a tenacious defense. Instead, Baghdad fell in only 21 days. Even taking the superiority of coalition forces into account, the collapse was stunning. Why did it happen?

Analysis shows that Iraq's rapid collapse was due to a combination of factors, beginning with strategic miscalculations on Saddam Hussein's part. A key blunder was his belief that the coalition would not attack or, if it did, that it would confine operations to air attacks or an attack from the west. One consequence of this miscalculation was that Iraqi ground forces remained maldeployed to the east and to the north; hence, badly positioned to counter an attack from the south. If for some reason the coalition launched a ground attack, Saddam believed his forces would prove strong enough to force a negotiated settlement. In this case, he miscalculated (or forgot) a lesson from the first Gulf War, namely, that Iraqi soldiers surrendered and deserted in droves when attacked by coalition forces vastly superior in terms of their professionalism, mobility, and accurate firepower.

A second factor was Saddam's preoccupation with internal threats to his person as well as his regime. This abiding concern caused him to impose security measures and shape his forces with an eye to forestalling coups rather than defending the country. A third factor was shortcomings—in planning, leadership, command and control, coordination, battlefield positioning, situational awareness, and training—that plagued the Iraqi forces and the obsolete equipment on which they had to rely. Additionally, the sum of these shortcomings was an army devoid of motivation whose morale was at

rock bottom. The glaring weakness of the Iraqi forces conditions any lessons that can be drawn from this conflict. Better-motivated forces with competent leaders could have mounted a much more tenacious defense, particularly in cities, where the advantages of U.S. and coalition maneuver capabilities are less clear or compelling. Also, had not Saddam viewed an invasion as unlikely, he might have adopted scorched earth tactics that could have complicated the coalition's operations considerably.

Some of the actions Saddam took, however, fueled the insurgency that continued to plague coalition forces long after he was deposed. These included such actions as large-scale arming of Ba'athist and tribal loyalists, widely dispersing weapon and munition stockpiles to minimize their vulnerability, releasing criminals from jail, and inviting foreign fighters into Iraq, some of whom survived the war to carry on the insurgency. These steps did not call the insurgency into being, but they provided the initial impetus for it to develop and, later, to flourish.

What lessons might future adversaries draw from the devastating defeat inflicted on the Iraqi army? One lesson can be drawn directly from the tactics of the insurgents in Iraq. Future foes may recognize the benefit of having capabilities available to wage an insurgency, especially in view of the problems that type of warfare later caused the United States and its coalition partners in Iraq. Another lesson potential adversaries might draw is that the United States will likely use force preemptively to prevent them from acquiring weapons of mass destruction (WMD), a policy the Bush administration proclaimed before the invasion of Iraq. They might also conclude, as a result, that the quest for WMD is futile, and they could abandon it. Alternatively, they might redouble their efforts to obtain such weapons clandestinely—especially nuclear weapons—since yet another lesson they could draw from the war is that one way to compensate for (and deter use of) the conventional edge enjoyed by the United States and its coalition partners is to proliferate. A final lesson is that, regardless of how effective their ground forces may be, potential adversaries cannot fail to recognize the contribution that U.S. air supremacy makes to the success of U.S. and coalition ground forces. Such adversaries, therefore, seem likely to pay strict attention to ways of offsetting (or at least mitigating) the effects of U.S. air supremacy.

Managing the War: How Well Did Commanders Maintain Control over the Myriad of Activities Involved?

Conducting an operation the size and scope of OIF required the participation of elements from most U.S. military organizations, the CIA and other U.S. government agencies, coalition partners, and friendly nations in the region. The functions these various elements performed included everything from detailed operational planning and execution of combat missions to humanitarian assistance and postconflict governance. Activities such as information operations now require almost as much of a

commander's attention as more traditional combat operations, such as fire support and maneuver. All of this activity presents a major command and control challenge.

The term "managing the war" is used here to draw attention to that challenge. It encompasses a wide range of activities associated with providing combatant commanders the tools required to control friendly forces, understand both friendly and enemy dispositions well enough to gain "situational awareness," conduct information operations, assess bomb damage, and deal with the media. The authorities and the procedures established to exercise command and control over coalition and U.S. forces consisted of a combination of doctrinal and ad hoc constructs that worked reasonably well throughout OIF.

Situational Awareness: How Good Was It?

Within the military today, situational awareness is taken to mean knowledge of both the friendly and the enemy conditions a commander has to deal with. It consists of the information that the commander and his forces need to prosecute their campaign, and it includes actionable intelligence, an important ingredient of ground combat.

Perhaps the most important problem facing commanders on the modern battlefield is how to gain sufficient awareness of the situation to favorably affect combat operations that are moving at a pace never before experienced. Gaining situational awareness at all levels involves the collection of information, its processing and fusion, and its dissemination to decisionmakers in time to make a difference. This did not always go as well as it could have during OIF.

Battle damage assessment (BDA) is closely related to situational awareness. Assessments of the damage caused by air or artillery strikes make the ground commander aware of the effectiveness of the enemy he is about to face. In OIF, such information often was not available to commanders because the assets used to conduct BDA were given other, higher-priority tasks. Space assets, for example, effectively supported several other combat missions. They facilitated navigation, via the Global Positioning System (GPS), communications, and surveillance using national and other resources.

At the end of major combat operations in Iraq, headlines were filled with claims of "unprecedented situational awareness." Allegedly, new sensor technologies painted a clearer picture of the battlefield than commanders had ever experienced. Nevertheless, tactical commanders at brigade level and below repeatedly said that they had relied on movement-to-contact and armed reconnaissance to gain an understanding of the enemy facing them, just as their predecessors had done in World War II and earlier conflicts.

Although the two sets of claims appear to contradict each other, in reality they do not: The view that commanders and staffs had of the enemy depended on which side of the "digital divide" they happened to occupy. Those who claim unprecedented

situational awareness refer to the vantage point of commanders at fixed locations (usually component commanders and above)—a view of OIF based, in part, on “unprecedented sensor coverage.” Those who contend that finding the enemy meant drawing his fire are simply acknowledging that intelligence derived from sensors rarely, if ever, got to them in enough time and detail to make a difference.

During OIF, sensor coverage of the battlespace was indeed unprecedented. However, sensor coverage alone does not necessarily translate into situational awareness. Timely processing and dissemination are needed as well, as is information at an appropriate level of resolution, to be useful to tactical commanders. Once combat operations began on March 19, 2003, the ability of tactical units to receive regular, useful intelligence updates depended heavily on the communications assets available. Regardless of the quantity and quality of intelligence products, once ground forces crossed the line of departure, intelligence support deteriorated because the wideband communications systems needed to receive intelligence products were not always available. Only when the units stopped were they able to gain access to intelligence—provided the unit had access to sufficient bandwidth. Even then, the amount of data to be downloaded often exceeded the capacity and time available. Given the pace of ground maneuver in OIF, intelligence analysts typically had only a few hours to process any backlogged intelligence, surveillance, and reconnaissance data from combatant and theater command centers.

The most critical problem was the inability to track enemy forces and gain current estimates of their strength. Commanders received reports of hundreds of Iraqi prepared positions along the two main avenues of approach to Baghdad but little information on the strength of the defenses at those positions or the movement of enemy forces. By contrast, commanders were able to track friendly forces in the cluttered tactical environment of Iraq. The Blue Force Tracker (BFT) component of the Force XXI Battle Command Brigade and Below (FBCB2) provided a means not only to track friendly forces but also to communicate with them via a rudimentary email system (a feature of the satellite-based version of BFT). BFT was also used for navigation when visibility was poor. Its ability to place friendly forces on a high-resolution digitized map allowed unit commanders to direct their forces through built-up areas at night. Although far from perfect, BFT was effective in all three areas because of its ability to receive and transmit both terrestrial and non-line-of-sight signals.

Winning Hearts and Minds: How Well Did We Do?

Information operations (IO) focus on influencing the enemy and the indigenous population in such a way as to reduce the risk to coalition forces. By using electronic interference they also attempt to deny access to communications systems, disrupt enemy communications, and deceive the enemy. How successful these operations were in OIF

is hard to determine because of the difficulties associated with linking the IO actions taken to effects directly attributable to those actions.

Finally, this conflict introduced a new concept in reporting about the war. For the first time in recent history, several hundred journalists were “embedded” with forces engaged in combat and often provided more timely news than the high command’s daily briefings.

Managing the Peace: How Bad Was It?

When the statue of Saddam Hussein in Baghdad was toppled on April 9, 2003, that symbolic event marked the end of a tyrannical regime that had ruled Iraq for almost three decades. However, it was not at all clear what alternative government would replace the fallen regime. Looters took to the streets, damaging much of Iraq’s infrastructure, which U.S. forces had labored to leave intact throughout the preceding three weeks of major combat operations. Iraqi police and military units were nowhere to be found, having largely dispersed during the period of major combat operations. U.S. military forces in Baghdad and elsewhere in the country were not prepared for the widespread looting that spun into chaos.

During the following weeks and months, U.S. civilian and military officials struggled to develop an approach to reconstructing Iraq. That country bore no resemblance to the peaceful, functioning state they had assumed would emerge from the war. As noted in the “Planning” section above, lack of sufficient prior planning for the peace—or, more accurately, a basically ineffective interagency planning process—contributed directly to the civil unrest that followed once the war’s major combat operations had come to an end.

The single most important failure in the postwar planning and execution process was the failure to assign responsibility and resources for providing security in the immediate aftermath of major combat operations. In the end, the job of plugging this postwar security gap fell to Army and Marine Corps forces. For what seemed like an interminable transition period, they became responsible for establishing security—until local forces could be reconstituted or retrained.

From May 2003 and continuing beyond June 2004, when the interim Iraqi government officially took charge of the country, an insurrection mounted within Iraq. This new enemy, consisting of loose coalitions of former Ba’athists, Iraqi Islamists, and foreign fighters, waged a relentless war against coalition forces and the new Iraqi government by attacking Iraqi infrastructure, government officials, civilian targets, and coalition military. As of June 2004, the Iraqi resistance had conducted over 13,000 attacks against U.S. and coalition forces and Iraqi infrastructure. Moreover, by that time an overwhelming majority of the Iraqi public had come to view U.S. military forces as foreign occupiers rather than liberators.

Why, then, were the U.S. government and the military apparently so unprepared for the challenges of postwar Iraq? First, prewar planning assumptions and expectations were not seriously challenged, even as postwar events began to indicate that most of those assumptions were invalid. Second, interagency coordination was ineffective: the National Security Council did oversee a formal interagency coordination process but focused it primarily on humanitarian relief efforts rather than reconstruction requirements (largely because of the unchallenged assumption that reconstruction requirements would be minimal); tensions between the State and Defense departments went unmediated by the President or his staff; and, despite the Defense Department's being named the lead agency for postwar Iraq in January 2003, its lack of capacity for civilian reconstruction efforts continued to pose problems throughout the occupation period. Third, and most important, there was a failure—noted above—to focus on security as the key postwar task.

Sustaining the Force: How Well Did OSD's Request-for-Forces Process and the Army's Distribution Based Logistics Concept Work in Iraq?

Preparing U.S. forces to participate in OIF involved the mobilization of active and reserve units, to include the Individual Ready Reserve, as well as the deployment of those forces to the Iraqi theater of operations. The OIF deployment differed greatly from that of DESERT STORM, which involved a lengthy buildup of troops, machines, and materiel that lasted six months. Planners rejected such an approach in OIF for reasons both tactical and practical. Tactically, they believed that Saddam might expect coalition forces to repeat the lengthy buildup leading to DESERT STORM and shape his plans to fit such a buildup. Practically, there was far less need to follow a deliberate buildup model. The United States had already established a large force presence in the region. It had quietly moved additional forces into the region, and it had improved its ability to deploy forces quickly. Furthermore, the Iraqi army was a shadow of its former self, and even that 1991 army had been unable to mount a serious challenge to coalition forces in DESERT STORM.

Forces were deployed to the Gulf for OIF using the Request for Forces (RFF) process. While more agile than traditional deployment procedures, the RFF system had disadvantages as well. One was that it required approval of each force package, which opened it to micromanagement at multiple levels. Final approval of each RFF was at the Secretary or Deputy Secretary of Defense level. The RFF could be approved, modified, or denied. Secretary of Defense Donald Rumsfeld claimed that the use of the RFF system was necessary to help the President align the diplomatic and military roads to war. However, the RFF system did not mesh well with the plans and expectations of units anticipating a different set of deployment procedures. This was particularly true of the reserve components (RC), whose mobilization procedures involved a series of

preplanned steps and an expected timeline. As a result of the time consumed as well as the procedural complexity associated with bringing a reservist onto active duty, many RC members did not show up at the right time or in the correct order, and some members who were called up were not used.

Once deployed, the force was sustained through supplies and materiel delivered to units at three levels: tactical, theater, and strategic. The rapid advance of U.S. forces that toppled Saddam Hussein's regime was made possible by a robust fuel supply and distribution system and a leaner system for other supplies and materiel that proved adequate but barely so. Strategic planning for OIF was predicated on the application of a new support concept called Distribution Based Logistics (DBL). In contrast to the logistics operations of the first Gulf War, DBL does not call for an initial buildup of large stockpiles in the theater of operations. Instead, it uses much smaller stockpiles and relies more on the rapid and reliable delivery of supplies. Overall, the new support concept worked. That said, for all classes of supply other than fuel, problems occurred. And in one critical class of supply—spare parts—the supply and distribution system failed at times for some units, due in part to a lack of on-the-move command and control capability.

Logistics problems in OIF occurred both during major combat operations and for some time during postcombat operations. Among these were distribution problems, including brief disruptions in the flow of supplies, and shortfalls in the national supply of some items. At various times, these logistical problems increased risk, affected quality of life, and affected equipment readiness.

The reasons for the problems are varied and complex. Some occurred because the Army and its strategic distribution partners (specifically U.S. Transportation Command and the Defense Logistics Agency) had not completed their joint transition to the DBL concept. Other issues stood apart from that concept and would have posed problems regardless of the support concept chosen, especially in the face of the unforeseen scale, duration, and intensity of the counterinsurgency operation that developed after the fall of Saddam.

The Future of Warfare: How Transformational Was Operation IRAQI FREEDOM?

In a time of “transformation,” the term of art in this period, decisionmakers wanted to know what OIF portended for the future of warfare, even though the final chapters on that operation may not be written for some time. All want to draw lessons from this conflict as well as learn how the United States planned and executed it, and they want to learn these lessons as soon as possible. To meet this need, OIF should be studied intensively. It has broad implications for U.S. policy, both defense and foreign, and for U.S. armed forces in particular.

Did OIF exemplify transformation? On the one hand, the answer to this question is yes. Sensor coverage (e.g., via Global Hawk, JSTARS, Predator, and tactical unmanned aerial vehicles) was exceptional, and Blue Force Tracker greatly improved situational awareness of and for U.S. forces. Even heavy ground forces maneuvered very rapidly, bypassing resistance in the rush to capture Baghdad. Air attacks not only supported but also complemented ground maneuvers, and two-thirds of air-delivered munitions were precision guided. Jointness, particularly in command, control, and communications, reached an all-time high. In part as a result of such transformational effects, Iraqi forces usually collapsed before being destroyed.

On the other hand, the answer to the question is no, OIF did not exemplify transformation. Situational awareness, as well as some sensor coverage, was lacking at the tactical level, allowing Iraqi forces to achieve tactical surprise on a number of occasions. Much more often than not, the passive protection of heavy armor had to substitute for timely situational awareness; it provided improved survival capability against unexpected enemy first strikes. Furthermore, large numbers of infantry—old-fashioned boots on the ground—were required to help secure the peace. Finally, those Iraqi forces that collapsed before being destroyed also did so, in part, because they were poorly led and had never recovered from DESERT STORM.

Rather than speculate on what OIF supposedly implied for transformation, it might be more productive to discern what the invasion of Iraq did *not* portend for the future of warfare. It did not support arguments that U.S. forces need to be more rapidly deployable, because the United States dictated the pace of events and could take whatever time it needed. It did not suggest that U.S. forces should shift emphasis from close combat to stand-off fires. On the contrary, close combat was essential to flush enemy forces and to defeat them. It did not offer any glimpse into a future in which U.S. land forces could develop situations while still out of contact with the enemy. Indeed, enemy forces usually went undetected before engagement. It certainly did not indicate that U.S. land forces could safely trade armor for some combination of situational awareness and firepower. Instead, it strongly suggested that, for the foreseeable future, heavily armored vehicles would remain essential; that tactical units would continue to rely on, as well as welcome improvements in, organic means for gaining situational awareness; and that firepower needs could best be met by integrating air- with ground-based systems.

To the extent that it contains lessons that can be trusted, OIF strongly suggests that the United States will continue to need a balanced mix of land forces—ranging from small, light special operations forces to large, heavily armored and mechanized forces—to accomplish a broad range of future missions, from major combat operations to stability and support, security, and reconstruction tasks. It also shows that the integration of special operations forces and conventional forces is haphazard and demands attention. Moreover, it suggests that urban combat is unavoidable when the United States has to occupy a country or region. Urban combat will require combined arms

teams well supported by air forces. Even in cities, the preferred means of fire support will often be precision-guided surface and air-delivered ordnance. The invasion of Iraq in 2003 demonstrated that highly responsive airpower provides land force commanders with a trump card but that the Army and the Air Force must work harder to achieve the seamless integration envisioned in joint doctrine.

In the end, judgments and recommendations drawn from OIF must be hedged with the caveat that what worked against Saddam Hussein's regime might not work against a more competent opponent. Because of Saddam's brutal, capricious, and inept leadership, the Iraqis were unprepared for the invasion and demoralized even before it began. Moreover, given poor training, inferior equipment, and tangled command relationships, they seldom used their weapons effectively. Ironically, the invasion was far less perilous and costly to U.S. forces than the subsequent occupation; postwar insurgents proved to be more dangerous than Saddam's army.

Acknowledgments

We'd like to thank the Deputy Chief of Staff, G-3, U.S. Army, and the Deputy Chief of Staff, G-8, U.S. Army, for sponsoring the research in this publication. Special thanks also go to our reviewers, Paul Davis and Marten Van Heuven, both researchers at the RAND Corporation.

Acronyms

4ASOG	USAF 4th Air Support Operations Group
32nd AAMDC	32nd Army Air and Missile Defense Command
AAV	Amphibious Assault Vehicle
ABN	Airborne
ACA	Airspace Control Authority
ACP	Assault Command Post
ACR	Armored Cavalry Regiment
AD	Armored Division
AEF	Air Expeditionary Force
AFFOR	Air Force Forces
AGOS	Air-Ground Operations System
AHR	Attack Helicopter Regiment
ALO	Air Liaison Officer
AMC	Army Materiel Command
AMI	Army-Managed Items
APC	Armored Personnel Carrier
APOD	Aerial Port of Debarkation
APOE	Aerial Port of Embarkation
APS	Army Prepositioned Stocks
ARCENT	U.S. Central Command—Army
ARFOR	U.S. Armed Forces
ARSST	Army Space Support Team
ASAS	All Source Analysis System
ASL	Authorized Stockage List
ASOC	Air Support Operations Center
ATACMS	Army Tactical Missile System
ATBM	Anti-Tactical Ballistic Missile
ATO	Air Tasking Order
AVN	Aviation

AWCF	Army Working Capital Fund
BCL	Battlefield Coordination Line
BCT	Brigade Combat Team
BDA	Battle Damage Assessment
BFT	Blue Force Tracker
BLT	Battalion Landing Team
C2	Command and Control
C-5	Combined Staff Strategic Planning and Policy
CAOC	Combined Air Operations Center
CAS	Close Air Support
CBIST	Chemical Biological Intelligence Support Team
CCP	Consolidation and Containerization Point
CENTAF	Air Force Central Command
CENTCOM	U.S. Central Command
CENTRIX	Combined Enterprise Regional Information Exchange System
CFACC	Combined Forces Air Component Commander
CFLCC	Combined Forces Land Component Commander
CFMCC	Combined Forces Maritime Component Commander
CFSOCC	Combined Forces Special Operations Component Commander
CGS	Common Ground Station
CIA	Central Intelligence Agency
CJCS	Chairman of the Joint Chiefs of Staff
CJSOTF	Combined Joint Special Operations Task Force
CJTF	Combined Joint Task Force
COMSOCC	Combined Special Operations Component Commander
CONOP	Concept of Operations
CONUS	Continental United States
COP	Common Operational Picture
COSCOM	Corps Support Command
CPA	Coalition Provisional Authority
CRS	Congressional Research Service
CSG	Corps Support Group
DASC	Direct Air Support Center
DBL	Distribution Based Logistics
DIA	Defense Intelligence Agency
DLA	Defense Logistics Agency
DMPI	Desired Mean Point of Impact
DPICM	Dual Purpose Improved Conventional Munition
DS	Direct Support

DSCS	Defense Satellite Communication System
DSP	Defense Support Program
DTRA	Defense Threat Reduction Agency
EAC	Echelon-Above-Corps
EPW	Enemy Prisoner of War
ERDC	Army Engineer Research and Development Center
ESG	Executive Steering Group
ETAC	Enlisted Terminal Air Controller
EUCOM	U.S. European Command
EW	Electronic Warfare
FA	Field Artillery
FARP	Forward Arming and Refueling Point
FBCB2	Force XXI Battle Command Brigade and Below
FIF	Free Iraqi Forces
FOB	Forward Operating Base
FPF	Final Protective Fire
FSB	Forward Support Battalion
FSCL	Fire Support Coordination Line
GEM	Guidance Enhanced Missile
GETS	GPS Enhanced Theater Support
GPO	Government Printing Office
GPS	Global Positioning System
GSS	General Security Service (Iraq)
HMMWV	High-Mobility, Multipurpose Wheeled Vehicle
HS	Home Station
HUMINT	Human Intelligence
HVT	High-Value Target
ID	Infantry Division
IGC	Iraqi Governing Council
IIG	Iraqi Interim Government
IIS	Iraqi Intelligence Service
ILA	Iraq Liberation Act
I MEF	1st Marine Expeditionary Force
IMSL	Iraq Master Site List
INA	Iraqi National Accord
INC	Iraqi National Congress
IO	Information Operations
IPDS	Inland Petroleum Distribution System
IPMC	Iraq Political-Military Cell

IR+R	Iraq Relief and Reconstruction Working Group
ISG	Iraq Survey Group
J-2	Designation for the Joint staff component charged with collecting and disseminating intelligence
JACE	Joint Analysis and Control Element
JDAM	Joint Direct Attack Munition
JIACG	Joint Interagency Coordination Group
JOC	Joint Operations Center
JSOTF	Joint Special Operations Task Force
JSOTF-N	Joint Special Operations Task Force–North
JSOTF-W	Joint Special Operations Task Force–West
JSTARS	Joint Surveillance Target Attack Radar System
JTF-A	Joint Task Force Alpha
JTIDS	Joint Tactical Information Distribution System
JTTP	Joint Tactics, Techniques, and Procedures
KADEK	Kurdistan Freedom and Democracy Congress
KAZ	Kurdish Autonomous Zone
KDP	Kurdish Democratic Party
KI	Killbox Interdiction
KTO	Kuwait Theater of Operations
LAV	Light Armored Vehicle
LD	Line of Departure
LOC	Line of Communications
LSA	Logistics Support Area
MARCENT	U.S. Marine Corps Central Command
MARFOR	U.S. Marine Corps Forces
MAW	Marine Air Wing
MEB	Marine Expeditionary Brigade
MEF	Marine Expeditionary Force
MET	Mobile Exploitation Team
MEU	Marine Expeditionary Unit
MILALOC	Military Air Line of Communication
MLRS	Multiple Launch Rocket System
MPAT	Multi Purpose Anti-Tank
MSB	Main Support Battalion
MSE	Mobile Subscriber Equipment
MTI	Moving-Target Indicator
NBC	Nuclear, Biological, Chemical
NGA	National Geospatial-Intelligence Agency

NGO	Nongovernmental Organization
NSC	National Security Council
OA	Obligation Authority
OAF	Operation ALLIED FORCE
OASD(PA)	Office of the Assistant Secretary of Defense for Public Affairs
OCONUS	Outside CONUS
ODA	Operational Detachment A (or Alpha) (Special Forces)
ODB	Operational Detachment B (or Bravo) (Special Forces)
OEF	Operation ENDURING FREEDOM
OFF	Oil for Food Program
OIF	Operation IRAQI FREEDOM
ONW	Operation NORTHERN WATCH
OPCON	Operational Control
OPLAN	Operations Plan
OPP	Office of the Presidential Palace
ORHA	Office of Reconstruction and Humanitarian Assistance
OSD	Office of the Secretary of Defense
OSP	Office of Special Plans
PA	Public Affairs
PAC	Patriot Advanced Capability
PFC	Private First Class
PLGR	Precision Lightweight GPS Receiver
PMO	Project Management Office
POL	Petroleum, Oil, and Lubricant
PSAB	Prince Sultan Air Base
PSYOP	Psychological Operations
PUK	Patriotic Union of Kurdistan
PVNT	Positioning, Velocity, Navigation, and Timing
RAAF	Royal Australian Air Force
RAF	Royal Air Force
RC	Reserve Components
RCC	Revolutionary Command Council
RCT	Regimental Combat Team
R&D	Research and Development
RFF	Request for Forces
RG	Republican Guard
RO	Requirements Objective
ROP	Reorder Points
RPG	Rocket Propelled Grenade

RWT	Requisition Wait Time
SAM	Surface-to-Air Missiles
SARC	Spectral Analysis Resource Center
SCA	Space Coordinating Authority
SCAR	Strike Coordination and Reconnaissance
SDP	Strategic Distribution Platform
SETAF	Southern European Task Force
SFG	Special Forces Group
SIGINT	Signals Intelligence
SIOE	Space and Information Operations Element
SJFHQ	Standing Joint Force Headquarters
SLGR	Small Light GPS Receiver
SMDCO	Space and Missile Defense Command Operations Center
SOCCENT	Special Operations Command Central
SOF	Special Operations Forces
SRG	Special Republican Guard (Iraq)
SSE	Sensitive Site Exploitation
SSET-L	Space Support Element Toolset–Light
SSM	Surface-to-Surface Missile
SSO	Special Security Organization (Iraq)
SSS	Special Security Service (Iraq)
SST	Site Survey Team
TACON	Tactical Control
TACP	Tactical Air Control Party
TACSAT	Tactical Satellite
TAL	Transitional Administrative Law
TAMD	Theater Air and Missile Defense
TAOC	Tactical Air Operations Center
TBM	Theater Ballistic Missile
TDC	Training Development Capability
TF	Task Force
TFIV	Task Force IV
TLAM	Tomahawk Land Attack Missile
TOC	Tactical Operations Center
TPFDD	Time-Phased Force Deployment Data
TPT	Tactical PSYOP Team
TST	Time Sensitive Target
UAE	United Arab Emirates
UAV	Unmanned Aerial Vehicle

UN	United Nations
UNMOVIC	United Nations Monitoring, Verification, and Inspection Commission
UNSC	United Nations Security Council
UNSCOM	United Nations Special Commission
UNSCR	United Nations Security Council Resolution
USA	U.S. Army
USAF	U.S. Air Force
USAID	U.S. Agency for International Development
USAREUR	U.S. Army Europe
USMC	U.S. Marine Corps
USN	U.S. Navy
UW	Unconventional Warfare
WMD	Weapon of Mass Destruction
WMSL	WMD Master Site List
WRSI	War Reserve Secondary Items
XTF	Exploitation Task Force

Introduction

Operation IRAQI FREEDOM (OIF) was launched on March 19, 2003, to rid Iraq of its weapons of mass destruction, to eliminate Saddam Hussein's regime, and to replace it with a democracy supported by the people of Iraq. As the title of this work suggests, the coalition achieved a decisive victory against Iraqi forces, which led to the collapse of Saddam's regime, but struggled afterward to secure the peace.

What Iraqi military resistance there was evaporated early, enabling the coalition to take Baghdad in 21 days. Advanced military technologies such as precision-guided munitions, unmanned aerial vehicles (UAVs), sophisticated sensor suites, and new devices like Blue Force Tracker (BFT), which was used to control friendly forces and prevent fratricide, contributed to victory, some for the first time. U.S. and coalition forces simply overwhelmed the enemy and proclaimed an end to major combat operations by May 2003.

Managing the aftermath of this victory proved to be much more problematic. U.S. and coalition troops in Iraq were increasingly seen as an occupation force. Events such as the prisoner abuse scandals at the Abu Ghraib prison served to reinforce the Iraqis' belief that the coalition did not have Iraqi interests at heart. In a 2004 Gallup poll, for example, 67 percent of Iraqis surveyed said that the coalition was not trying to protect them during gunfire exchanges.¹ This perception—that the coalition was not devoted to helping Iraq and Iraqis—complicated coalition efforts throughout the postwar period.

This work documents the story of OIF from its root causes in the first Gulf War through continuing operations up to the transfer of authority to the Iraqi government on June 28, 2004. This focus lends more weight to the warfighting activities than it does to those that occurred after major combat operations. The whole story encompasses such issues as national strategy, operational planning and organization, air and ground force operations, mobilization of reserves, deployment and logistics operations, coalition operations, and civil-military operations. While this work focuses primarily

¹ Results of a poll conducted in Iraq in March and April 2004 by Gallup.

on Army forces, the document also pays attention to other components and aspects of the joint and multinational fight.

Sources of Our Data

The documentation and accompanying analysis of events presented here are based on a review of contemporary records as well as on interviews with key participants in OIF. Although we drew our information from a wide variety of sources, these sources generally fell into three categories: government documents, published documents, and interviews. Government documents included those from the U.S. military and other government agencies. Military documents consisted of operational plans and orders, fragmentary orders, messages, memoranda, lessons learned, after action reports, and formal reports on the conflict. Many of the unclassified materials collected for this study remain unpublished and therefore are not available to the general public.

Published documents ran the gamut from articles in newspapers, periodicals, and journals to books published about the conflict, including those written by key players such as General Tommy Franks, commander of U.S. Central Command (CENTCOM), or by those, such as journalist Bob Woodward, who interviewed key players. This category also includes published congressional testimony. We also had access to official documents from the Coalition Provisional Authority.

Interviews encompassed a wide range of people involved in OIF. Specific sources include General Franks, Lieutenant General William Wallace, the commander of V Corps, his division commanders, and many Army and Marine Corps brigade, regiment, and battalion commanders. We also conducted group interviews among Army and Marine Corps units that participated in the operation.

Timeline and Reference Map

To provide the reader with some additional background and orientation, this chapter includes a timeline (see below) chronicling the major events that occurred between February 6 and May 19, 2003.

This monograph focuses mainly on major combat operations: the period from the attempted decapitation strike on March 19, 2003, through April 14, 2003, and the capture and occupation of Tikrit. However, at various places in the text we discuss events before and after this time period. At times, the narrative does not conveniently begin on March 19 or end on April 14.

The graphical depiction in Figure 1.1 summarizes the timeline. The map of Iraq in Figure 1.2 provides a convenient reference for the many geographical locations that are cited in the text.

Figure 1.1
Chronology of Events Relating to Operation IRAQI FREEDOM

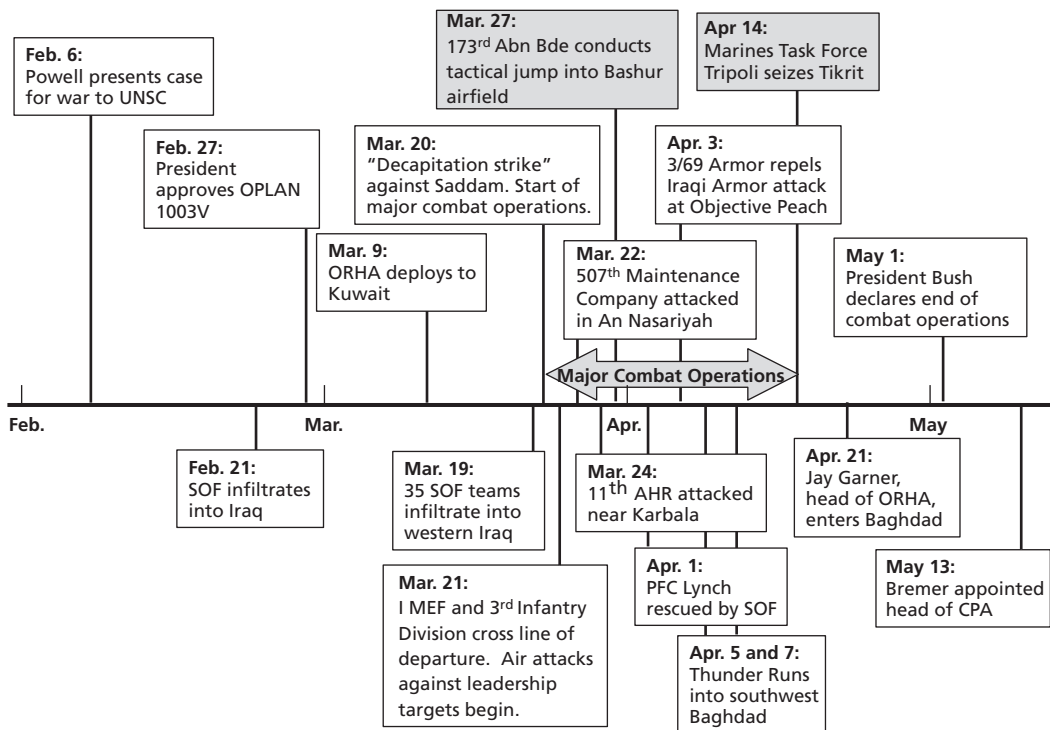

RAND MG641-1.1

February 2003

- 6 Secretary of State Colin Powell presents case for war to United Nations (UN) Security Council.
- 14 UN Monitoring, Verification, and Inspection Commission (UNMOVIC) briefs the Security Council.²
- 21 Prewar infiltration of special operations forces (SOF) into Iraq.
- 27 Final version of OPLAN 1003V approved.

March 2003

- 1 First leaflets dropped on air defense sites in northern Iraq
- 9 Office of Reconstruction and Humanitarian Assistance (ORHA) personnel deploy to Kuwait.

² United Nations, "UNMOVIC Chronology of Main Events," 2003.

Figure 1.2
Iraq



SOURCE: Perry-Castañeda Library map collection, University of Texas at Austin, produced by the CIA, http://www.lib.utexas.edu/maps/middle_east_and_asia/ (as of September 10, 2004).
RAND MG641-1.2

18 President Bush’s speech lays out the case for war and sets a 48-hour deadline for Saddam and his sons to leave Iraq.³

³ White House, “President Says Saddam Hussein Must Leave Iraq Within 48 Hours,” Press Release, March 17, 2003.

- UN weapons inspectors leave Iraq.⁴
- 19 Leaflets and radio broadcasts deliver capitulation instructions to Iraqi forces. Visual observation posts along Iraq's border with Syria and Saudi Arabia destroyed by SOF units.
35 SOF teams infiltrate into western Iraq and prepare to seize airfield.
2 SOF operational detachments infiltrate into Iraq by ground.
Elements of Task Force 20 (SOF) (TF-20) infiltrate into Iraq and prepare to seize western airfields and weapons storage facilities suspected of housing weapons of mass destruction (WMDs).
- 20 "Decapitation Strike" at Baghdad compound against leadership targets.⁵
Infiltration of SOF in the north begins.
Elements of TF-20 conduct raids against weapons storage facility at Ar Rutbah.
Navy SEALs and Polish GROM (SOF) seize Al Faw oil pumping and pipeline facilities.
- 21 3rd Infantry Division and 1st Marine Expeditionary Force (I MEF) cross the line of departure into Iraq.⁶
Air strikes against command and control and leadership targets in southern sector begin.
U.S. and British marines capture the port of Umm Qasr.⁷
British marines seize the Faw peninsula.⁸
- 22 507th Maintenance Company attacked in An Nasiriyah.⁹
3rd Brigade, 3rd Infantry Division, seizes Tallil Air Base south of An Nasiriyah and a bridge spanning the Euphrates.¹⁰
First Sensitive Site Exploitation in southern Iraq conducted.
- 23 3rd Infantry Division seizes objectives RAIDERS and RAMS near An Najaf.

⁴ "UNMOVIC Chronology of Main Events."

⁵ White House, "President Bush Addresses the Nation," Press Release, March 19, 2003. Evan Thomas and Daniel Klaidman, "The War Room," *Newsweek*, March 31, 2003; "The War So Far," *Washington Post*, March 23, 2004, p. A34.

⁶ "The War So Far"; 3rd Infantry Division (Mechanized), *Operation Iraqi Freedom, After Action Report*, Fort Stewart, Georgia, 2003.

⁷ "The War So Far."

⁸ "The War So Far."

⁹ U.S. Army V Corps, "V Corps, The Road to 'Victory!' in Operation Iraqi Freedom," briefing, Heidelberg, Germany, June 2003.

¹⁰ Rajiv Chandrasekaran and Peter Baker, "Air and Land Offensive Gathers Speed; Marines Seize Major Port in South as Armored Units Speed Through Iraqi Desert Toward Baghdad," *Washington Post*, March 23, 2003, p. A1.

- Patriot downs a British Tornado GR4, killing the two-man crew.¹¹
Task Force Tarawa enters An Nasiriyah amid heavy fighting, suffers the largest single losses of any company-sized element in the war.
TF-20 seizes western Iraq desert landing strip.
- 24 Near Karbala, Apache helicopters from the 11th Aviation Regiment conduct a deep attack against the Medina Division;¹² one Apache shot down, all other aircraft damaged.¹³
Sandstorm slows the ground force advance.¹⁴
- 25 U.S. Air Force F-16 destroys the radar of a Patriot battery after Patriot radar locks on and prepares to shoot it.¹⁵
- 26 Lead elements of the 173rd Brigade (Airborne) conduct a night mass tactical jump from 15 C-17 aircraft at the Bashur airfield in northern Iraq.
- 27 3rd Infantry Division attacks to isolate An Najaf.¹⁶
- 28 Operation VIKING HAMMER begins to destroy Ansar al-Islam base at Khurmal and seize suspected WMD weapons facility.

April 2003

- 1 SOF rescue PFC Jessica Lynch.¹⁷
Army Rangers from TF-20 seize Hadithah Dam.
British Special Boat Service unit is ambushed at a location near Mosul and is forced to exfiltrate without major equipment.
- 2 Patriot downs a Navy F/A-18C fighter, killing the pilot.¹⁸
3/69 Armor, 1st Brigade, 3rd Infantry Division, seizes bridge over Euphrates River at Objective PEACH, southwest of Baghdad.¹⁹
- 3 3/69 Armor, 1st Brigade, 3rd Infantry Division, repels largest organized Iraqi armored counterattack of the war at Objective PEACH.

¹¹ Vernon Loeb, "Patriot Downs RAF Fighter," *Washington Post*, March 24, 2003.

¹² Mary Beth Sheridan, "Ground Fire Repels Copter Assault," *Washington Post*, March 25, 2003, p. 1; Michael R. Gordon, "The Goal Is Baghdad, But at What Cost?" *New York Times*, March 25, 2003.

¹³ 3rd Infantry Division (Mechanized).

¹⁴ U.S. Army V Corps, "V Corps, The Road to 'Victory!' in Operation Iraqi Freedom."

¹⁵ Andrea Stone, "Patriot Missile: Friend or Foe to Allied Troops," *USA Today*, April 15, 2003, p. 6.

¹⁶ U.S. Army V Corps, "V Corps, The Road to 'Victory!' in Operation Iraqi Freedom."

¹⁷ Rowan Scarborough, "Special Ops Say Lives Were on Line in Lynch's Rescue," *Washington Times*, June 9, 2003.

¹⁸ Associated Press, "U.S. Missile Killed Pilot of Navy Fighter," *International Herald Tribune*, April 15, 2003.

¹⁹ 3rd Infantry Division (Mechanized).

- 4 3/69 Armor, 1st Brigade, 3rd Infantry Division, reaches Saddam International Airport.²⁰
- 5 First “Thunder Run” made into southwest Baghdad conducted by elements of 2nd Brigade, 3rd Infantry Division.²¹
- 6 3rd Brigade, 3rd Infantry Division, advances to northern edge of Baghdad.²²
- 7 Second Thunder Run made into Baghdad by 2nd Brigade, 3rd Infantry Division. This time the U.S. force remains in the heart of the city.²³
- 9 Army and Marine Corps forces move freely through Baghdad as the government collapses. Saddam’s statue is pulled down.²⁴
- 10 1st Battalion, 5th Marines, attacks into northeast Baghdad, last major fighting of the war.
SOF accept ceasefire agreement with Iraqi 5th Corps and begin movement into Mosul.
SOF and large contingent of peshmerga arrive in Kirkuk and find the city abandoned by the Iraqi military and government.
- 12 The 26th Marine Expeditionary Unit deploys into Mosul to maintain security until the arrival of the 101st Airborne Division.
173rd Brigade (Airborne) establishes security in Kirkuk.
- 14 Task Force Tripoli occupies Tikrit.²⁵
- 20 Army forces assume responsibility for Baghdad as Marine Corps forces reposture.²⁶
- 21 Jay Garner, head of ORHA, enters Baghdad.²⁷
- 27 Headquarters (HQ) V Corps begins move from Camp Virginia in Kuwait to west of Baghdad.²⁸

²⁰ Steven Lee Meyers, “At Airport, Bombs Provide the Only Light,” *New York Times*, April 4, 2003; 3rd Infantry Division (Mechanized).

²¹ Rajiv Chandrasekaran and Peter Baker, “U.S. Force Probing Inside Baghdad,” *Washington Post*, April 5, 2003; 3rd Infantry Division (Mechanized).

²² 3rd Infantry Division (Mechanized).

²³ 3rd Infantry Division (Mechanized).

²⁴ Anthony Shaddid, “Hussein’s Baghdad Falls,” *Washington Post*, April 10, 2003.

²⁵ 1st Marine Division, *After Action Report*, 1st Marine Division, Operation Iraqi Freedom, Camp Pendleton, California, 2003.

²⁶ John Kifner and Ian Fisher, “Marines End Role in Iraq’s Capital as Army Moves In,” *New York Times*, April 21, 2003.

²⁷ Monte Reel, “Garner Arrives in Iraq to Begin Reconstruction,” *Washington Post*, April 22, 2003.

²⁸ David Josar, “V Corps Shifting Headquarters from Kuwait to Baghdad Area,” *European Stars and Stripes*, April 27, 2003.

May 2003

- 1 President Bush declares the end of major combat operations on board the USS *Abraham Lincoln*.
- 13 Paul Bremer appointed Administrator of the Coalition Provisional Authority (CPA).

How the Book Is Organized

This book contains ten chapters. Following the introduction, Chapter Two covers the origins of the war, its political underpinnings, the growth of Saddam's security forces, UN sanctions, and U.S. policy, which involved both containment and regime change. Chapter Three details the operational planning for OIF and its aftermath at CENTCOM. Next come Chapters Four and Five, which are central to the OIF story; they detail the ground and air operations, joint operations, the role of special operations forces, ballistic missile defense, air control measures, coordination of joint fires, and the hunt for weapons of mass destruction. Chapter Six examines the strategy and behavior of Saddam's regime in planning to defend against the coalition. Chapter Seven tackles the myriad problems associated with managing the complex force assembled to conduct OIF; these include command and control relationships, the collection and processing of intelligence to support situational awareness, space operations, battle damage assessment, information operations, and the media. Chapter Eight focuses on civilian efforts to deal with the postwar period; it includes the problem of interagency coordination, the role of the Office of Reconstruction and Humanitarian Assistance (ORHA), the Coalition Provisional Authority, the occupation of Iraq, governance, security forces, economic policy, and reconstruction. Chapter Nine describes operations surrounding the mobilization, deployment, and sustainment of U.S. forces participating in the coalition. Finally, Chapter Ten reports on conclusions drawn from all aspects of the OIF story and makes recommendations aimed at improving the planning and execution of future combat operations and postconflict environments.

Genesis of the War

*Jefferson P. Marquis, Walter L. Perry, Andrea Mejia,
Jerry M. Sollinger, Vipin Narang*

Wars do not happen spontaneously. Even when precipitated by a sudden event—the invasion of Kuwait or the attack on Pearl Harbor—they typically have their roots in events that occurred years or decades before the fighting begins. The war in Iraq is no exception. As was the case with World War II, the seeds of the second Gulf War were sown in the first. But the picture is more complex than that. Over a decade of efforts to contain the regime of Saddam Hussein, although largely successful, resulted in a sense of frustration in the West at his seeming ability to thwart the United Nations sanctions imposed on his country and retain his iron grip on Iraq. This was compounded by the perception that Saddam Hussein was continuing to develop and stockpile weapons of mass destruction and by the events of 9/11.

Political Underpinnings

“War is nothing more than the continuation of politics by other means.” One implication of Clausewitz’s oft-quoted phrase is that to understand the genesis of any war, one must analyze the political environment from which it emerged. To that end, this chapter describes the historical, political, diplomatic, and strategic context that underlay and affected the course of Operation IRAQI FREEDOM. Analysis of the contextual environment lends insight into why and how (1) the outcome of the first Gulf War, (2) the UN-sponsored regime of sanctions and weapons inspections that was imposed on Iraq, and (3) efforts to counter terrorism following 9/11 contributed to the success of the United States and its coalition partners in OIF’s opening combat phase. At the same time, these three elements also added to the difficulties confronting the coalition in the stability and reconstruction phase of the conflict.

For the most part, the contextual analysis presented here addresses the three main elements identified above chronologically. The analysis begins by describing the immediate impact of the first Gulf War. Then it explores the evolution of the policy that was used to “contain” Saddam in the twelve years between the two Gulf wars. It also indicates how ambivalent policies toward Saddam Hussein’s regime on the part

of three U.S. administrations and other countries affected Iraq's geopolitical situation. Finally, the analysis addresses the fundamental change in U.S. national security strategy that followed the 9/11 terrorist attacks against the United States. It tracks the diplomatic process that ensued, from President Bush's September 2002 address to the UN, demanding immediate and full cooperation from Iraq in assuring the elimination of Baghdad's WMD programs, to the onset of the U.S.-led military intervention in March 2003.

Aftermath of the First Gulf War

The roots of OIF reach back to Operation DESERT STORM. The end of the first Persian Gulf War in 1991 created conditions that would increase the likelihood of future military action. The aftermath of that conflict also affected the capabilities of both the United States and Iraq to conduct military operations against one another in 2003.

The coalition victory in DESERT STORM significantly degraded Iraq's conventional military capabilities. At least on paper, Iraq possessed formidable conventional military forces prior to the first Gulf War. A typical estimate put the army at 750,000 troops, divided among ten corps and 67 divisions. In addition, Iraq was estimated to have roughly 5,800 tanks, 5,100 armored personnel carriers, 3,850 pieces of artillery, 25 naval vessels, and 650 combat aircraft.¹ Prewar estimates indicate that Iraq deployed about 60 percent of its assets to the Kuwait theater of operations (KTO).² Although postwar assessments of damage vary widely,³ the Iraqi military is estimated to have lost from 1,800 to 3,700 tanks,⁴ 50 to 90 percent of its artillery, and a third to half of its armored personnel carriers.⁵ The navy was essentially destroyed as a result of DESERT STORM, as well as most of Iraq's best combat aircraft.⁶

¹ Michael Eisenstadt, *Like a Phoenix from the Ashes: The Future of Iraqi Military Power*, Washington, D.C.: Washington Institute for Near East Policy, 1993, p. 43. Eisenstadt notes that these estimates include large numbers of nonoperational equipment kept in storage.

² Eisenstadt, p. 43. It was initially thought that over 500,000 troops were deployed to the KTO, but the actual number is more likely to have been from 360,000 to 400,000. See Stephen T. Hosmer, *Effects of the Coalition Air Campaign Against Iraqi Ground Forces in the Gulf War*, Santa Monica, CA: RAND Corporation, MR-305/1-AF, 2002, pp. 18–20.

³ There were scant postwar battle damage assessment (BDA) data, and there were methodological flaws in the BDA assessments conducted by U.S. CENTCOM—Army (ARCENT). See Hosmer.

⁴ GlobalSecurity.org, "Iraqi Ground Forces Equipment," August 21, 2003. See also Paul K. White, "Airpower and a Decade of Containment," *Joint Forces Quarterly*, Winter 2000–01, pp. 35–39. The most comprehensive account of the damage inflicted by the DESERT STORM coalition on Iraqi forces can be found in Thomas A. Keaney, *The Gulf War Air Power Survey*, Vol. 2: *Operations and Effects and Effectiveness*, Washington, D.C.: Office of the Secretary of the Air Force, 1993.

⁵ Hosmer; Eisenstadt.

⁶ "Cracks Within Iraq's Army," *Jane's Intelligence Review*, November 1, 1994.

In part, the devastation wreaked on Iraq's military was a reflection of the inferior quality of Iraqi forces in relation to those of their opponents. Despite the large size of Iraq's military, the majority of its troops were relatively poorly trained. Also, much of its equipment was obsolete. For example, only about 1,000 of its tanks, less than 20 percent, were T-72s. In addition, prewar U.S. intelligence overestimated Iraq's divisional manning and readiness levels as well as its commanders' ability to coordinate their air and ground forces. The biggest miscalculation in favor of the coalition was the willingness of the Iraqis to stay and fight. It is estimated that up to 42 percent of the army in the KTO deserted before the ground campaign even began,⁷ while only 15 percent of the Republican Guard and other heavy divisions attempted to fight.⁸

In spite of its overwhelming victory in the first Gulf War, the coalition failed to achieve one of its primary goals: the destruction of the Iraqi Republican Guard, which possessed much of Iraq's best military equipment. After the war, the Central Intelligence Agency (CIA) determined that half the Republican Guard forces in the KTO had escaped, even though most of these forces had been deployed directly in the path of the allied attack when the ceasefire was declared.⁹ As a result, over 700 of the Republican Guard's T-72 tanks are believed to have survived the first Gulf War, as well as over 50 percent of its total assets.¹⁰

Thus, despite the great damage to Iraq's military wrought by DESERT STORM, Saddam Hussein's regime remained more than capable of forcibly suppressing internal dissent. This capability would become a significant issue for the coalition in the days, months, and years following DESERT STORM. Under the Safwan Accords signed on March 1, 1991,¹¹ Iraq was allowed to keep most of its conventional military forces.

Although DESERT STORM accomplished the goal of ejecting the Iraqis from Kuwait, it did not break the power of Saddam Hussein. His premier combat force, the Republican Guard, was wounded but not mortally so. It retained about half of its fighting capability. If it was something less than an effective fighting force when matched against coalition troops, and thus not a threat to them, the Republican Guard still retained enough capability to ensure Saddam's grip on Iraq. Surviving Republican

⁷ Carl Conetta, "Catastrophic Interdiction: Air Power and the Collapse of the Iraqi Field Army in the 2003 War," *Air Force Magazine*, September 26, 2003.

⁸ There were many reasons for this. The Iraqi soldiers were weary from the Iran-Iraq War, the KTO conditions were very harsh, the air campaign was devastating both physically and psychologically, and there was doubt among them regarding the validity of the Kuwaiti invasion. See Hosmer.

⁹ According to information from spy plane surveillance on March 1. See Michael R. Gordon and Bernard E. Trainor, *The Generals' War: The Inside Story of the Conflict in the Gulf*, Boston: Little, Brown, and Company, 1995.

¹⁰ Eisenstadt.

¹¹ The agreements between U.S. and Iraqi military leaders that outlined the ceasefire conditions were named after the location of the meeting that took place on March 1, 1991.

Guard units, supported by attack helicopters, would prove decisive in putting down Iraqi civilian uprisings that erupted in the wake of Iraq's withdrawal from Kuwait.¹²

Uprisings

On January 16, 1991, President George H.W. Bush told the Iraqi people to “take matters into their own hands and force Saddam Hussein, the dictator, to step aside.” Within a few days of the February 28 ceasefire, many of the Iraqi people tried to do just that. Led by Kurdish forces in the north and Shi'ites¹³ in the south, uprisings broke out in 17 of Iraq's 18 provinces. These uprisings would have profound implications for the second Gulf War.

The uprisings in southern Iraq seem to have been driven by urban Shi'ites tired of Sunni Ba'athist rule, often joined by disaffected members of the Iraqi military as it retreated from Kuwait. Although the rebellion reached Baghdad, Saddam quickly and brutally suppressed the uprisings within days of the Safwan agreement. The Republican Guard was sent south first, attacking Karbala on March 8. The Shi'ites fought with rocket-propelled grenades (RPGs) and light arms, but they were no match for Saddam's much better armed and disciplined ground forces.¹⁴ Shi'ite religious leaders, who had taken charge of the rebellion, reportedly asked for U.S. support on March 11, but Washington rejected their request.¹⁵ The Republican Guard then moved on to An Najaf, and by mid-March it had effectively suppressed the Shi'ite revolts.

Despite the first Bush administration's rhetorical support, the Shi'ites received no assistance from U.S. forces remaining in the area. Because coalition forces had been ordered to destroy the weapon caches they captured in DESERT STORM, Shi'ite rebels even lost access to one of the few potential sources of arms available to them.¹⁶ Although Thomas Pickering, the U.S. Ambassador to the UN, had proposed a demilitarized zone for southern Iraq, his proposal met with too much resistance from CENTCOM and State Department leaders, who were concerned that a civil war in the south might break up the country and prompt the intervention of foreign powers—in particular, Iran.¹⁷ It is estimated that 30,000 to 60,000 Shi'ites were killed as a result of the

¹² Sean Boyne, “Iraq Retains Ability to Quell Revolts,” *Jane's Intelligence Review*, January 1, 2002.

¹³ The term *Shi'ites* is generally used to identify those who follow a particular type of Islam, but the Shia community is a heterogeneous mix of classes and traditional organizations such as tribes. See Faleh A. Jabar, “Clerics, Tribes, Ideologues and Urban Dwellers in the South of Iraq: The Potential for Rebellion,” *The Adelphi Papers*, Vol. 354, No. 1, April 17, 2003, pp. 161–178.

¹⁴ Gordon and Trainor.

¹⁵ Juan Cole, “The United States and Shi'ite Religious Factions in Post-Ba'thist Iraq,” *Middle East Journal*, Vol. 57, No. 4, Autumn 2003, p. 549.

¹⁶ Gordon and Trainor.

¹⁷ Gordon and Trainor.

uprisings.¹⁸ Saddam's Special Security Service (SSS) played a key role in the aftermath, with reports that its members alone executed over 10,000 prisoners.¹⁹

After suppressing the Shi'ites, the Republican Guard was sent north, where the Kurdish majority had taken over a number of cities. Without military support from the United States, the last Kurdish-held city fell to the Republican Guard on April 3. Having experienced Iraqi reprisals in the past, over 1.5 million Kurds fled their homes as the Iraqi army pushed north. The majority fled to Iran, but nearly 450,000 went to Turkey, and several thousand others sought refuge in Saudi Arabia, Kuwait, Syria, and Jordan.²⁰ By mid-March 1991, there were reports that nearly 1,000 Kurds a day, primarily the elderly and children, were dying in the mountains.

Faced with a growing humanitarian disaster, the UN Security Council passed Resolution 688 on April 5, 1991, which demanded an "immediate end" to the repression of Iraq's civilian population and "immediate access by international humanitarian organizations to all those in need of assistance in all parts of Iraq."²¹ Under the auspices of this resolution, the first President Bush launched Operation PROVIDE COMFORT on April 16. Initially a humanitarian relief operation,²² PROVIDE COMFORT established a security zone for coalition forces, the UN, and nongovernmental organizations (NGOs) providing aid. To assist in the security effort, President Bush declared the area north of the 36th parallel off-limits to Iraqi aircraft.

The post-Gulf War uprisings had important consequences for the United States and its allies. These uprisings resulted in the northern no-fly zone (Operation NORTHERN WATCH), which was followed by a southern no-fly zone (Operation SOUTHERN WATCH) that covered much of the area inhabited by Iraq's Shi'ite population.²³ Both zones resulted in a 12-year commitment of forces, primarily U.S. and British air forces. The way the United States handled the uprisings had a more subtle effect. By extending its protection to the Kurdish people, on the one hand, the United States raised Kurdish expectations of freedom from Baghdad's control and an independent Kurdish state.²⁴ On the other hand, these heightened expectations raised concerns

¹⁸ Amatzia Baram, *Between Impediment and Advantage: Saddam's Iraq*, Washington, D.C.: U.S. Institute of Peace, Special Report 34, 1998.

¹⁹ Sean Boyne, "Iraq's Security Network, Part 2," *Jane's Intelligence Review*, Vol. 9, Issue 7, July 1, 1997.

²⁰ Eric Goldstein, *Endless Torment: The 1991 Uprising in Iraq and Its Aftermath*, New York: Human Rights Watch, 1992.

²¹ United Nations, "UN Security Council Resolution 688," April 5, 1991.

²² Gordon and Trainor.

²³ In 1994, the United States also proclaimed a "no drive" zone south of the 32nd parallel in an attempt to limit Baghdad's ability to quickly reposition and resupply its ground forces in southern Iraq.

²⁴ Despite explicit U.S. warnings that the northern no-fly zone did not constitute a safe haven, both the Kurds and U.S. government officials in practice saw it as such; thus the United States was guaranteeing Kurdish security to a large extent.

among regional states, such as Turkey, about the influence a potentially independent Kurdish state might have on Turkey's own Kurdish citizens. Turkish concerns would grow, as regime change in Iraq became a stated U.S. goal.

More positively, U.S. support for the Kurds helped to insulate an opposition force that might be used in future military actions against Iraq. It also facilitated the creation of an autonomous Kurdish area that was, by regional standards, quite well governed. Potentially less positive, the U.S. government's unwillingness to respond to the request for assistance from Shi'ite resistance leaders, which enabled Saddam Hussein's forces to massacre tens of thousands of southerners, created substantial resentment within Iraq's Shi'ite community.²⁵ Arguably, U.S. neutrality during the 1991 uprising also left Iraqi Shi'ites fearful that future U.S. military actions would leave Saddam Hussein in power and their community vulnerable to his reprisals should they rise up prematurely.

Military Reorganization and Growth of Saddam's Security Forces

After the first Gulf War, Saddam reorganized his military in response to the losses his forces had experienced during DESERT STORM,²⁶ as well as to his fear of internal uprisings and the threat of coups d'état. Most of Iraq's militias were dissolved and large numbers of the regular infantry were simply disbanded. Saddam also replaced or reassigned the defense minister, the chief of staff, and almost every general staff officer and corps commander in the Iraqi army.²⁷ By 1994, the conventional army had been reduced from 67 divisions to 30, with an estimated strength of 400,000.²⁸ The new army was reorganized around the Republican Guard units that remained after DESERT STORM. Not only did these units have the best equipment, they had also proved their loyalty by defending Saddam against the greatest threat to his rule, the March 1991 uprisings. The Republican Guard was initially reconstituted around eight divisions—three armored, one mechanized, and four infantry. It decreased from a force size of 150,000 in 1990 to about 80,000 in 1992.²⁹

At the same time, Saddam greatly expanded the network of security agencies that monitored all life in Iraq. Saddam had risen to power through his control and creation of security forces, so it is not surprising that he turned to them in the aftermath of the Gulf War and the resulting revolts against him. Four agencies predated the Gulf War. These were Military Intelligence, the Iraqi Intelligence Service (IIS), the Special Secu-

²⁵ Cole, p. 549.

²⁶ Eisenstadt.

²⁷ Eisenstadt.

²⁸ "Cracks Within Iraq's Army."

²⁹ Andrew Rathmell, "Iraq's Military—Waiting for Change," *Jane's Intelligence Review*, Vol. 7, No. 2, February 1995.

rity Service (SSS), and the General Security Service (GSS).³⁰ All these security agencies reported directly to the Office of the Presidential Palace (OPP), which allowed Saddam to maintain centralized control.

Three new agencies were created in 1992. The Special Republican Guard (SRG) was founded with a force size of 15,000, divided into 13 battalions. Its recruits were from areas and clans noted for their loyalty to Saddam, and it was the only significant military unit allowed inside Baghdad. The SRG's primary responsibility was to protect Saddam and provide a military response to any rebellion or coup, although it also seems to have acted as a bridge between the regular army and the security agencies.³¹ The Military Security Service (Amn Al-Askariyya) was to detect and deal with dissent in the armed forces.³² Finally, Saddam's son Uday created the Fedayeen Saddam, or Saddam's Martyrs.³³ Their primary duty was to protect Saddam from domestic opponents, although they were also heavily involved in patrolling Baghdad and in anti-smuggling duties.

Over time, the security apparatus became even more centralized, with key members being directly related to Saddam or his tribe. In particular, Saddam's son Qusay took charge of much of the security apparatus, becoming commander of the Republican Guard, the SRG, and the SSS. Under Qusay the SSS grew to 5,000 men in 1995 and its authority expanded to include investigation of the other security agencies.³⁴ The increase in the size and power of the security forces seems to have proved its worth in the sense that several attempted coups were thwarted in the 1990s.³⁵ On the other

³⁰ Military Intelligence (Mudiriyyat al-Istikhabarat al-'Askariyya al-'Amm) dated back to 1932. Its primary focus was military threats from abroad and opposition from the Kurds. Saddam created the IIS (al-Mukhabarat) in 1973, also known as the General Intelligence Directorate. Its focus was internal security, but it also carried out intelligence and assassination operations. The SSS (al-Amn al-Khas), also known as the Special Security Organization, was formed at the end of the Iran-Iraq War. It was created to replace the Republican Guard when that unit was expanded from a small presidential guard force into a large military organization. It was originally founded with about 1,000 members. The GSS (al-Amn al-'Amm), also known as the Secret Police, was focused on local internal security. Members were stationed in police stations in every town and village, with an overall force of about 8,000. See Ibrahim Al-Marashi, "Iraq's Security and Intelligence Network: A Guide and Analysis," *Middle East Review of International Affairs*, Vol. 6, No. 3, September 2002.

³¹ The SRG worked with the SSS, and together they were known as the Organization of Special Security (OSS). See GlobalSecurity.org, "Special Republican Guard," June 10, 2004.

³² The service was moved out from under Military Intelligence and became an independent agency that reported directly to OPP. See Sean Boyne, "Iraq's Security Network, Part 2," *Jane's Intelligence Review*, Vol. 9, Issue 8, August 1, 1997.

³³ Uday was removed as commander of the Fedayeen Saddam in 1996 as a punishment for murdering one of his father's bodyguards with a hammer.

³⁴ Boyne, "Iraq's Security Network, Part 2."

³⁵ These included a coup attempt in June 1992, an RPG attack on Saddam's motorcade in July 1994, and a CIA-led coup attempt that was exposed in June 1996. See Robin Wright, "Iraqi Attack Ends CIA Attempt to Overthrow Saddam Hussein," *The Ottawa Citizen*, September 8, 1996, p. A6; Sean Boyne, "Iraq's Military Purge," *Jane's Intelligence Review*, Vol. 8, No. 10, October 1, 1996; Sean Boyne, "Iraq's Security Network, Part 1," *Jane's Intelligence Review*, Vol. 9, Issue 7, July 1, 1997; and Sean Boyne, "Iraq's Security Network, Part 2."

hand, repeated purges of officers in the Republican Guard led to a further deterioration of Iraq's conventional military capability.³⁶ Like his hero, Josef Stalin, Saddam indulged his paranoia over the possibility of a conspiracy within the top ranks of the professional military; this paranoia would have drastic consequences when it came time to deal with an invasion by a formidable military opponent.

That said, the increased attention paid to security units, rather than a more professional military, may have inadvertently strengthened the ability of regime loyalists to wage insurgency operations following the fall of the regime in May 2003. First, the members of the security forces were drawn from Saddam's own tribe or the area around his hometown of Tikrit. Thus their futures were connected to the fate of Saddam, which presumably made them loyal protectors of the regime. Second, the security forces were concentrated in Iraq's major cities, raising the prospect of urban warfare. Tariq Aziz, Iraq's deputy prime minister, warned prior to OIF that coalition forces would "have to fight us here on the streets of Baghdad, on the streets of Mosul, and on the streets of each and every Iraqi city and town." Finally, there is evidence that officers in Saddam Hussein's security and intelligence apparatus began to plan insurgent attacks against U.S. forces before the fall of Baghdad and continued to provide tactical guidance to anti-U.S. insurgents in places like Fallujah since the end of major combat operations in Iraq.³⁷

U.S. Regional Footprint Grows After First Gulf War

The United States developed and enhanced a strong military coalition structure, as well as a robust infrastructure, in the Middle East following the first Gulf War. This buildup made it almost impossible for Saddam Hussein to contemplate military action outside Iraq's borders and greatly facilitated the U.S.-led offensive against Iraq in 2003. Prior to DESERT STORM, the United States had only a token military presence in the Middle East, including a prepositioning squadron at Diego Garcia in the Indian Ocean. The closest substantial U.S. forces were in Germany and the Philippines. The United States had, however, helped Saudi Arabia build several air bases, including one of the largest in the world at Dhahran.

Since the defense of Saudi Arabia was one of the initial motivating factors for military action in DESERT STORM, obtaining expanded access to the kingdom was

³⁶ Just prior to OIF, the Republican Guard had an estimated strength of 60,000 to 70,000. More recent estimates suggested the SRG had about 15,000 to 26,000 members while the Fedayeen had 30,000 to 40,000. There were approximately 8,000 in the GSS, 4,000 to 6,000 in Military Intelligence, and another 5,000 in the SSS. This amounts to an additional 60,000 to 80,000 potential combatants outside the traditional military. See Al-Marashi, "Iraq's Security and Intelligence Network: A Guide and Analysis."

³⁷ Thom Shanker, "Hussein's Agents Are Behind Attacks in Iraq, Pentagon Finds," *New York Times*, April 29, 2004.

essential for conducting the war. Although the United States never signed a formal status-of-forces agreement with Saudi Arabia, U.S. access to air bases and seaports increased after DESERT STORM. Such arrangements provided political ammunition to Islamic radicals, however; they mounted terrorist attacks against U.S. military targets in the Saudi kingdom, such as the bombing of the Office of the Program Manager, Saudi Arabian National Guard (OPM/SANG), in November 1995. As a result, the United States withdrew its forces from Dhahran and Riyadh and consolidated them at Prince Sultan Air Base (PSAB) in 1996.³⁸ Nevertheless, the U.S. and Saudi militaries continued to cooperate. For example, as the location of the Combined Air Operations Center (CAOC), PSAB played a crucial role in both ENDURING FREEDOM and IRAQI FREEDOM.

U.S. access to other states on the Arabian Peninsula also expanded as a result of the first Gulf War. Kuwait and Bahrain both signed ten-year bilateral agreements with the United States in the fall of 1991. Security agreements with Oman extended back to 1981.³⁹ Although such agreements with the United Arab Emirates (UAE) and Qatar only began after 1998, both countries allowed the United States access during the first Gulf War. In 1992 the United States was permitted to use UAE air and naval facilities, and in 1994 it reached a Defense Cooperation Agreement that permitted naval prepositioning.⁴⁰ A 1992 bilateral agreement with Qatar gave the United States access to air and naval facilities, and, in 1995, the Emirate formally agreed to the prepositioning of heavy equipment for one U.S. mechanized brigade.⁴¹ The air base at Al Udeid, which itself added substantially to U.S. military aircraft capabilities in the Gulf, was used extensively during the war in Afghanistan, and construction of a new base, the largest outside the United States, began in 2001.⁴²

As a result of Operation SOUTHERN WATCH (OSW) and more limited U.S. and allied military responses to Iraqi violations of UN agreements (explained below), the U.S. military presence in the Gulf region grew substantially in the early-to-mid 1990s. Although these forces consisted primarily of U.S. air and naval elements, the U.S. Army's contingency presence included several Patriot air defense batteries and a

³⁸ Duncan Anderson, "The Build-Up," in John Pimlott, *The Gulf War Assessed*, London: Arms and Armour, 1992.

³⁹ The Bahrain agreement gave the United States access to ports and airfields, and it authorized the use of several warehouses for prepositioning equipment. Cooperation was expanded in 1995 when the United States was allowed to establish headquarters for the 5th Fleet at Juffair. ARCENT maintains a base at Camp Doha, near Kuwait City, and Air Force Central Command (CENTAF) uses two Kuwaiti air bases. The Oman agreements allow access to facilities at four air bases and two ports, as well as providing for an ARCENT staging base. See "Military Bases That U.S. Could Use," Associated Press, Military.com, September 26, 2001.

⁴⁰ Anthony Cordesman, *USCENTCOM and Its Area of Operations*, Washington, D.C.: Center for Strategic and International Studies, April 1998.

⁴¹ Cordesman, 1998.

⁴² "Military Bases That U.S. Could Use."

battalion task force that intermittently deployed to Kuwait for Exercise INTRINSIC ACTION as well as the prepositioning of one mechanized brigade in Qatar (noted above). In 1991, the United States also deployed forces to Iraq's northern flank in support of Operation NORTHERN WATCH (described below). Run by the Air Force Central Command (CENTAF) out of Incirlik Air Base in southeast Turkey, this was primarily a U.S. Air Force operation, which gradually declined in size throughout much of the 1990s.

The first Gulf War revealed key gaps in U.S. logistical capabilities in the Middle East, for example, the need for more extensive regional stockpiles of heavy equipment and supplies, both in POMCUS⁴³ sites and aboard maritime prepositioned ships.⁴⁴ The expansion of U.S. presence in the region indicated not only that the United States appeared to have learned its lessons from the war, but that many Gulf States recognized and accepted the U.S. role as guardian of the region. For instance, CENTCOM established its forward headquarters in Kuwait at Camp Doha, where it prepositioned combat equipment for a heavy brigade. In addition, the expanded U.S. footprint in the Gulf enabled multinational training between the United States and the Gulf States, improving readiness and capability for any potential military action in the region. U.S. rotational units and Kuwaiti forces began conducting one regular exercise, Operation DESERT SPRING, in 1991. Such cooperation paid off. In 1994, when Saddam once again threatened Kuwait by moving forces toward the border with his southern neighbor, the United States was able to rapidly flood the area with forces and Saddam was forced to retreat.⁴⁵

The political implications of such increased U.S. presence were undoubtedly less favorable than the military consequences. With Muslims inside and outside Saudi Arabia—not least the leaders of al Qaeda—calling for the removal of U.S. forces from the kingdom, which contained the two holiest cities of Islam, and with terrorist incidents against westerners on the rise,⁴⁶ the U.S. government sought ways to lower its profile in Saudi Arabia, especially following the 9/11 attacks in New York and Washington, D.C., and the U.S.-Saudi tensions that resulted from those attacks because of the number of Saudi nationals involved, while still maintaining a capability for increased military action if necessary. Nevertheless, the Saudi government grew more hesitant to support U.S. Middle East policies, at least in public. The clearest example of

⁴³ Prepositioning of materiel configured to unit sets.

⁴⁴ For a summary of logistical lessons learned as a result of the first Gulf War, see Brigadier General Robert H. Scales, Jr., Director, Desert Storm Project, *United States Army in the Gulf War: Certain Victory*, Washington, D.C.: Office of the Chief of Staff, United States Army, 1993, pp. 368–378.

⁴⁵ DESERT SPRING was employed as a justification for shipping additional combat equipment to Kuwait in the run-up to OIF in the fall of 2002. See Robin Hughes, “USA Addresses Basing Options in Gulf Region,” *Jane's Defence Weekly*, September 25, 2002.

⁴⁶ The most deadly of these terrorist attacks was directed against the U.S. Air Force compound near Riyadh known as Khobar Towers in 1996, and resulted in the death of 19 American military personnel.

this was the Saudis' refusal to allow the United States and Britain to launch air attacks on Iraq from their bases during Operation DESERT FOX in 1998.⁴⁷

A Decade of Containment and Regime Change, 1991 to 2001

In retrospect, it is clear that the first President Bush, President Bill Clinton, and President George W. Bush—at least initially—all pursued a dual-track policy of containment and regime change. In the midst of DESERT STORM in February 1991, the first President Bush stated,

There is another way for the bloodshed to stop: And that is, for the Iraqi military and the Iraqi people to take matters into their own hands and force Saddam Hussein, the dictator, to step aside and then comply with the United Nations' resolutions and rejoin the family of peace-loving nations.⁴⁸

However, this rhetoric did not translate into support for the uprisings that actually occurred. The message seems to have been intended to provoke the Iraqi military into mounting a quick and relatively bloodless coup against Saddam—not to provide support for a popular uprising that might draw the United States into an Iraqi civil war and destabilize the region. Despite some internal dissent, the first Bush administration refrained from taking responsibility for forcibly removing Saddam, particularly if that meant breaking with its coalition partners. According to Colin Powell, “We were never going to Baghdad. The UN resolution said nothing about going to Baghdad. We wouldn't have gotten a UN resolution if it had.”⁴⁹

Containment: The UN Resolutions

By early April 1991, the necessary resolutions defining the end of the first Gulf War were in place.⁵⁰ Yet ten years later Iraq remained under international sanctions, with more than half its airspace patrolled by coalition aircraft. The UN Security Coun-

⁴⁷ Despite their reluctance to openly support post-DESERT STORM U.S. military actions, the Saudi government did permit the Combined Air Operations Center (CAOC) at Prince Sultan Air Base (PSAB), outside Riyadh, to serve as the nerve center of the initial OIF air campaign. However, on April 28, 2003, the conduct of air operations over Iraq moved to Al Udeid Air Base in Qatar. Tim Ripley, “U.S. to Move Headquarters Out of Saudi Arabia,” *Jane's Defence Weekly*, May 7, 2003.

⁴⁸ Brent Sadler, “The Unfinished War: A Decade Since Desert Storm,” *CNN Special Report*, January 16, 2001.

⁴⁹ U.S. Senate, *Testimony of Secretary of State Colin Powell*, Hearing of the Senate Foreign Relations Committee, Washington, D.C.: GPO, February 5, 2002.

⁵⁰ Prior to the Gulf War, UN Security Council Resolution (UNSCR) 661 (August 6, 1990) established the sanctions regime. Resolution 686 (March 2, 1991) set out the initial terms for the ceasefire, including returning all prisoners of war and making reparations to Kuwait. UNSCR 687 (April 3, 1991) described the long-term conditions of the ceasefire. These included an arms embargo and continued the economic sanctions until Iraq

cil never authorized the imposition of the no-fly zones, and over time some council members would openly question their legitimacy. Eventually, several factors would contribute to prolonging the standoff between Saddam and the international community. Among these were continued Iraqi noncompliance with UN resolutions, disagreement among UN Security Council members over what constituted compliance, and competing national interests. U.S. strategy and policy evolved into an attempt to use the UN resolutions, sometimes combined with unilateral military action, to contain Saddam.

The no-fly zones were not the only tools used to contain Saddam. The UN established a multilateral embargo on trade and finance with Iraq. It would become the longest-lasting and most comprehensive sanctions effort ever enacted by the UN. The sanctions prohibited all trade with Iraq, although they exempted medical supplies and humanitarian supplies of food.⁵¹ According to UNSCR 687, the sanctions were to be reviewed every 60 days, based on Iraqi compliance with “all relevant resolutions of the Security Council.”⁵² The sanctions were to be lifted once the Security Council agreed that Iraq had complied with all the criteria regarding its WMD capabilities. The resolution also put in place an arms embargo, which was separate from the trade sanctions.

The main unintended consequence of the sanctions regime was the humanitarian cost imposed on the Iraqi people by the Saddam regime. Although the actual figure is unknown, the number of deaths caused by the embargo was on the order of 350,000 to 450,000, most of whom were young children and elderly Iraqis.⁵³ There were several reasons why the sanctions had a devastating effect. First, Iraq’s infrastructure had already suffered as a result of its eight-year war with Iran in the 1980s. Second, like many oil-rich states, Iraq had an economy that depended on trade. The International Monetary Fund estimated that the economy shrank by two-thirds as a result of the embargo, and every sector was affected.⁵⁴ Thus, the 1997 Food Supply and Nutrition Assessment of the Food and Agricultural Organization/World Food Program tied

eliminated all of its WMD weapons and programs. UNSCR 688 (March 5, 1991) demanded that Iraq end the repression of its civilians and allow access to humanitarian organizations.

⁵¹ United Nations, “Security Council Resolution 661,” August 6, 1990.

⁵² United Nations, “Security Council Resolution 687,” April 3, 1991.

⁵³ If this number is combined with the 50,000 to 150,000 direct and indirect casualties of the first Gulf War, the Shi’ite uprising and the Kurdish revolt of March–April 1991, Iraq’s total death toll from the man-made disasters of the 1990s is comparable to the number of people who died in the Iran-Iraq War of the 1980s. For a careful assessment of the humanitarian impact of economic sanctions on Iraq, see Amatzia Baram, “The Effect of Iraqi Sanctions: Statistical Pitfalls and Responsibility,” *Middle East Journal*, Vol. 54, No. 2, Spring 2000, pp. 194–223. Without downplaying the impact of the sanctions, Baram rejects as grossly inflated the former Iraqi regime’s embargo-related mortality figure of 1.5 million. In addition, he indicates that some humanitarian organizations, such as UNICEF, exaggerated the dimensions of the food crisis in Iraq in the late 1990s by presenting the nutrition situation in areas that were particularly badly hit as typical of the whole country.

⁵⁴ “When Sanctions Don’t Work,” *The Economist*, April 8–14, 2000.

Iraqi health and sanitation problems mainly to a lack of medicine, medical equipment, and adequate sanitation.⁵⁵ The third reason for the humanitarian crisis was Saddam Hussein's ability to direct resources to key supporters while denying basic provisions to the general populace. Even so, Saddam was able to use the suffering of the Iraqi people to his advantage. Notwithstanding his own control over the Iraqi economy, Saddam was able to shift most of the blame for the dire effects of the sanctions onto the United States, and Washington did little to counter Iraqi propaganda.⁵⁶

In response to the increasingly desperate humanitarian situation in Iraq, the UN proposed what was to become the Oil for Food (OFF) Program. When Saddam finally accepted the program's terms in 1996, Iraq was allowed to sell up to \$1.32 billion of oil every six months to meet its citizens' nutritional and medical needs. In 1998, the UN more than doubled the amount of oil Iraq could sell, increased the ration basket, and allowed funds to go toward repairing infrastructure. On the plus side, the food supplies provided through OFF reversed a serious and deteriorating food crisis. On the negative side, Saddam's regime was able to circumvent the sanctions by corrupting OFF—through smuggling, kickbacks, and a variety of manipulative mechanisms.⁵⁷

From a military point of view, the sanctions had mixed but generally positive results. They deprived Saddam of revenue. The lack of funds plus the arms embargo severely crippled Iraq's ability to rebuild and modernize its military. The United States, which continued to modernize its military forces following the Gulf War, faced a conventional Iraqi military in 2003 that was not only smaller but also comparatively much weaker than the one it fought in 1991. But Saddam was able to blame the United States for imposing terrible hardships on the Iraqi people. This deflection of responsibility from himself to America had important effects on coalition partners, some of which came to believe that the United States would never agree to lifting the sanctions until Saddam had been replaced.⁵⁸

⁵⁵ Food and Agricultural Organization, *Global Information and Early Warning System*, FAO/WFP Food Supply and Nutrition Assessment Mission to Iraq, Rome: FAO, 1997.

⁵⁶ Matt Lewis, "Smart Sanctions: Shifting the Blame," Washington, D.C.: Center for Defense Information, June 25, 2001.

⁵⁷ Gerald C. Anderson, Director, Office of Peacekeeping, U.S. Department of State, Statement to the U.S. House of Representatives, Committee on Energy and Commerce, Subcommittee on Oversight and Investigations, May 16, 1995.

⁵⁸ The U.S. Secretary of State in the second Clinton administration, Madeleine Albright, says in her memoir, *Madam Secretary*, that she "personally didn't believe Saddam had any intention of complying" with all applicable UN Security Council resolutions (pp. 275–276). Thus, Albright thought, the sanctions against Saddam's regime might never be lifted. She attributes the unqualified position—namely, that sanctions would never be lifted as long as Saddam remained in power—to the first Bush administration. However, Albright acknowledges later in her memoir (p. 287) that when the United States bombed Iraq in 1998 following Saddam's expulsion of all UN weapons inspectors, the Clinton administration's policy changed from "containment with inspections to an approach we called containment plus" (p. 287). That "plus" consisted of regime change, which Clinton himself had suggested on November 14, 1997, in a speech following Saddam's refusal to allow entry of U.S. members of the UN

The weapons inspection process was a major facet of the effort to disarm Iraq, and it produced significant and positive results. The United Nations Special Commission (UNSCOM) destroyed thousands of chemical munitions and tons of chemical warfare agents. It also destroyed delivery vehicles and other equipment, including Russian-supplied SCUD ballistic missiles, mobile missile launchers, missile warheads, and chemical warfare production equipment.⁵⁹ The inspections uncovered a previously unknown and relatively advanced nuclear program. Inspectors believed that without the inspections, they would not have detected Iraq's nuclear program.

Based on the sheer number of weapons identified and destroyed, it is clear that UN inspections significantly eroded Iraq's chemical, biological, and missile capabilities and essentially eliminated its nuclear weapons program.⁶⁰ Unfortunately, in their final report before OIF, UN inspectors could not guarantee that Iraq no longer maintained at least some WMD assets and capabilities. This meant that the U.S. military still needed to take substantial precautions in planning for Iraq's potential use of WMD in combat against U.S. and coalition forces, against the Iraqi civilian population, and against Israel. Furthermore, DESERT FOX, the four-day bombing campaign in December 1998, which followed Saddam's ejection that year of UN inspectors and monitors from Iraq, "proved surprisingly effective."⁶¹ Indeed, the campaign had a devastating effect, according to David Kay's Iraq Survey Group, which tried to locate Iraqi weapons of mass destruction for the U.S. government after the war. The survey found that, except for missile building, all other weapons programs atrophied after 1998 and never regained momentum. Moreover, "the Desert Fox raids had left Iraqi weaponeers demoralized and despairing."⁶²

Regime Change

The first President Bush seemed to recognize early on that the war had come to an incomplete conclusion in April 1991.⁶³ Based on its actions over the next year, his administration grappled with trying to reconcile an underlying desire to see Saddam immediately removed from power with ongoing efforts to sustain the coalition and maintain support for UN sanctions and inspections that, the administration believed, sooner or later would lead to Saddam's ouster. The underlying goal of regime change,

weapons inspections team: "What he has just done is to ensure that the sanctions will be there until the end of time, or as long as he lasts." Madeleine Albright, *Madam Secretary: A Memoir*, New York: Miramax Books, 2005.

⁵⁹ Steve Bowman, *Iraq Chemical and Biological Weapons (CBW) Capabilities*, Washington, D.C.: CRS Report for Congress, 98-129F, September 4, 1998.

⁶⁰ See Thomas Ricks, *Fiasco: The American Military Experience in Iraq*, New York: Penguin Press, 2006, pp. 21–22 and 52–56.

⁶¹ Ricks, p. 19.

⁶² Ricks, p. 21.

⁶³ Gordon and Trainor.

however, would motivate the United States to take a much more aggressive approach than other coalition members almost immediately, as demonstrated most significantly with the imposition of the no-fly zones.

After taking office in 1993, President Bill Clinton announced a new U.S. policy for the Middle East. Dubbed “dual containment,” the new approach rejected the possibility of alternating support to Iran and Iraq in an attempt to maintain a balance of power in the region. Instead, the administration would attempt to contain both countries. Dr. Martin Indyk outlined the administration’s policy in May 1993.

The coalition that fought Saddam remains together as long as we are able to maintain our military presence in the region, as long as we succeed in restricting the military ambitions of both Iraq and Iran, and as long as we can rely on our regional allies Egypt, Israel, Saudi Arabia and the [Gulf Cooperation Council], and Turkey—to preserve a balance of power in our favor in the wider Middle East region, we will have the means to counter both the Iraqi and Iranian regions. We will not need to depend on one to counter the other.⁶⁴

In practice, however, the Clinton team basically adopted the same policy approach the first Bush administration had pursued, namely, internationally supported sanctions and inspections combined with the enforcement of the no-fly zones and support to opposition groups. Like its predecessor, the Clinton administration sent conflicting signals almost immediately. Specifically regarding Iraq, Indyk had stated: “We seek Iraq’s full compliance with all UN resolutions.” However, two paragraphs later he continued as follows:

Nor do we seek or expect a reconciliation with Saddam Hussein’s regime . . . Our purpose is deliberate: it is to establish clearly and unequivocally that the current regime in Iraq is a criminal regime, beyond the pale of international society and, in our judgment, irredeemable.⁶⁵

Over the next seven years the United States would attempt to use the UN resolutions, sometimes combined with unilateral military action, to contain Saddam. For example, the Clinton administration employed limited demonstrations of force in 1994, 1996, and 1998 to coerce Iraq into changing its behavior with regard to troop movements, meddling in Kurdish politics, and lack of cooperation with UN weapons inspectors. The largest of these strike operations, DESERT FOX, lasted from December 16 to 19,

⁶⁴ Martin Indyk, “The Clinton Administration’s Approach to the Middle East,” Sorel Symposium, The Washington Institute for Near East Policy, May 18, 1993.

⁶⁵ Indyk.

1998, and resulted in the launching of some 415 cruise missiles and the dropping of more than 600 bombs on 97 Iraqi military and industrial targets.⁶⁶

When the second Bush administration took office, it faced rapidly dwindling international support for sanctions and an inspections program that was, in its view, unsuccessful in finding Saddam's weapons of mass destruction. In addition, key Bush advisors and other leading Republicans had signed an "open letter to President Clinton" in 1998 that urged him to adopt a policy of regime change with respect to Iraq.⁶⁷

Nevertheless, the initial steps taken by the new Bush administration, from January through August 2001, appeared to support continuation of the policies toward Iraq developed by its predecessors. Iraq, however, was clearly a major concern from the very beginning. A meeting on Iraq with outgoing Secretary of Defense William Cohen took place in January, before the inauguration. In early February, a Principals Committee⁶⁸ reviewed the entirety of policy toward Iraq. As a result of this review, the new administration apparently decided to continue with the previous policy.⁶⁹ However, it also began to make some changes.

First, there was a change in the sanctions policy. Secretary of State Colin Powell clearly recognized the problems that the sanctions regime posed, particularly regarding international support, which was failing. As he stated on March 7, 2001:

The sanctions were starting to fall apart. Saddam Hussein and the Iraqi regime had successfully put the burden on us as denying the wherewithal for civilians and children in Iraq to live and to get the nutrition and health care they needed . . . What we've been trying to do for the last six weeks is to see how we could stabilize the collapsing situation and find some basis of stabilization that would bring the [pro-sanctions] coalition back together.⁷⁰

Second, the United States changed the engagement rules in the no-fly zones. Previously, strikes had been limited to air defense targets, primarily in response to Iraqi air defense attacks on U.S. and British planes. Under the new rules, the target list would be expanded to include activities banned under UN resolutions. According to Powell, "If and when we find facilities or other activities going on in Iraq that we believe are

⁶⁶ A description of Operation Desert Fox can be found in Alfred B. Prados and Kenneth Katzman, *Iraqi-U.S. Confrontation*, Washington, D.C.: Congressional Research Service, 2001.

⁶⁷ "Open Letter to the President," February 19, 1998.

⁶⁸ The Principals Committee includes the Secretary of Defense, the Secretary of State, and the National Security Advisor. The Deputies Committee (mentioned below), as its name suggests, consists of their deputies.

⁶⁹ In testimony before Congress, Powell described a three "basket" approach: maintaining sanctions, enforcing no-fly zones, and providing support to Iraqi opposition groups. U.S. House of Representatives, *Testimony of Secretary of State Colin Powell, Hearing of the House International Relations Committee*, Washington, D.C.: GPO, March 7, 2001.

⁷⁰ U.S. House of Representatives, *Testimony of Secretary of State Colin Powell*.

inconsistent with our [UN] obligations, we reserve the right to take military action against such facilities and will do so.”⁷¹

The United States met resistance in its pursuit of a new sanctions policy, as well as with regard to weapons inspections. Within the administration, and among UN members, there was also continuing disagreement over how dual-use items should be dealt with in the sanctions policy.

As indicated earlier, containment was always only one aspect of U.S. policy toward Iraq following DESERT STORM. Regime change was the other part of the equation, and its importance increased relative to containment in the years before the second Gulf War. Although it did not become official government policy until 1998, the United States was clearly interested in removing Saddam from power even before the first Gulf War ended. Over the course of twelve years, the United States supported a variety of attempts to remove Saddam, ranging from covert attempts at regime change to overt support of external opposition groups. However, all of these indirect attempts to get rid of Saddam ended in failure.

In response to growing crises over UNSCOM’s inspections, the United States began to move further away from containment and toward a policy of regime change in early 1998. The State Department received approval to use \$3 million in Economic Support Funds for an overt program to coordinate the diverse opposition groups, promote cooperation among various opposition leaders, and highlight Iraqi violations of UN resolutions. The United States also renewed its support for the Iraqi National Congress (INC).⁷² Although intra-Kurdish fighting had been a significant setback, the United States was able to mediate a ceasefire between the Kurdish Democratic Party (KDP) and its largest splinter group, the Patriotic Union of Kurdistan (PUK) in late October 1996. By September 1998 the leaders of the two factions met in Washington and agreed to settle their outstanding issues. On October 4, 2002, the Kurdish regional parliament was reconvened for the first time since fighting had broken out in 1994.

The Iraq Liberation Act (ILA) was signed into law on October 31, 1998. It gave the president the discretion to provide up to \$97 million in defense articles to opposition organizations. The INC did not receive its first direct payment until March 2000, and the full amount was not allocated, perhaps reflecting significant divisions within the Clinton administration over the effectiveness and viability of the Iraqi opposition. There was also significant concern about the potential for the United States to

⁷¹ John Diamond, “Powell Expands List of Facilities in Iraq That May Be Bombed,” *NCI*, March 8, 2001.

⁷² The Iraqi National Congress was created at the behest of the U.S. government for the purpose of fomenting the overthrow of Saddam Hussein. The INC had been funded since 1992. It received \$27 million from 2003 through 2007. In May 1991, following the end of Operation DESERT STORM, then-President George H.W. Bush directed the CIA to create the conditions for Hussein’s removal. The CIA did not have the mechanisms in place to make that happen, so it hired the Rendon Group, a PR firm run by John Rendon, to run a covert anti-Saddam propaganda campaign. Ahmad Chalabi was the principal spokesman for the INC.

become militarily embroiled in civil conflict in Iraq. About 150 Iraqi opposition members received training in civil affairs between 1999 and 2000, but there was no combat training or provision of military equipment.⁷³

By 2001 the likelihood of a successful coup seemed very remote. Over the intervening years Saddam had only increased his hold on Iraqi society and expanded his security network. The number of coup failures was a testament to his success in this regard. Change via outside opposition groups also seemed unlikely, since they lacked unity, training, and the necessary military capabilities. Regime change in Iraq seemed increasingly to depend on major military action.⁷⁴ In this respect, the ILA made future military action more, not less, likely.

U.S. experiences involving Iraq during the decade following DESERT STORM bore other military implications for the second Gulf War. The opposition's shortcomings made it clear that the "Afghan" model⁷⁵ would be unworkable as an approach to regime change in Iraq. Nevertheless, the connections established with the INC, the Iraqi National Accord (INA), and the Kurdish militias were in place, ready to be exploited, in the run-up to operations in OIF.⁷⁶

Statements from Governor George W. Bush during his campaign for the presidency gave no indication that he or his advisors were planning to remove Saddam via a military invasion. If anything, statements and writings from advisors such as Dr. Condoleezza Rice indicated a move away from international engagement, with a refocus on China, missile defense, and restructuring the military.⁷⁷ In particular, the new administration seemed determined to stop "nation-building," as evidenced by Rice's remark that "Carrying out civil administration and police functions is simply going to degrade the American capability to do the things America has to do. We don't need to have the 82nd Airborne escorting kids to kindergarten."⁷⁸ Since the costs of stabilizing Iraq in the aftermath of a military invasion had long been a major reason for avoiding such action, a military invasion seemed even more unlikely under the new administration.

⁷³ Kenneth Katzman, *Iraq: U.S. Regime Change Efforts and Post-Saddam Governance*, Washington, D.C.: CRS, January 7, 2004.

⁷⁴ Woodward.

⁷⁵ See Chapter Three for more detail.

⁷⁶ The Iraqi National Accord is an Iraqi political party founded by Iyad Allawi and Salah Omar Al-Ali in 1991. Al-Ali subsequently left the party after he realized the extent of Allawi's links to foreign intelligence agencies, mainly the CIA and MI6. It was founded at the time of the Persian Gulf War as an opposition group to Saddam Hussein.

⁷⁷ Condoleezza Rice, "Promoting the National Interest," *Foreign Affairs*, January/February 2000.

⁷⁸ Condoleezza Rice, quoted in Michael Gordon, "Bush Would Stop U.S. Peacekeeping in Balkan Fights," *New York Times*, October 21, 2000, p. A1.

Former Treasury Secretary Paul O'Neill, however, has claimed that the Bush administration took office fully intending to oust Saddam Hussein from power in Iraq. In an interview with the CBS television correspondent Leslie Stahl, O'Neill stated:

From the very beginning, there was a conviction, that Saddam Hussein was a bad person and that he needed to go. Going after Saddam was topic "A" 10 days after the inauguration—eight months before September 11. . . . It was all about finding a way to do it. That was the tone of it. The President saying "Go find me a way to do this."⁷⁹

Two days after this interview, in responding to O'Neill's statement and Ron Suskind's book on the subject, President Bush admitted that he was "in favor" of regime change before September 11, 2001.⁸⁰ In a statement made while visiting Mexico, he said:

The stated policy of my administration towards Saddam Hussein was very clear. Like the previous administration, we were for regime change. And in the initial stages of the administration, as you might remember, we were dealing with Desert Badger, or fly-overs and fly-betweens and looks, so we were fashioning policy along those lines.⁸¹

While not an admission that he was plotting direct military action against Saddam this early, the President's statement did confirm the administration's view that Saddam had to go. It also reinforces the point made earlier that regime change was a policy of previous administrations.⁸²

Before the 9/11 terrorist attacks that launched the global war on terrorism, the second Bush administration focused on developing an overall policy toward Iraq, not simply a military policy. On August 1, 2001, a paper entitled "A Liberation Strategy" was presented to the Deputies Committee.⁸³ It outlined a strategy for increasing pres-

⁷⁹ Paul O'Neill, interview with Leslie Stahl, January 11, 2004.

⁸⁰ Ron Suskind, *The Price of Loyalty: George W. Bush, the White House and the Education of Paul O'Neill*, New York: Simon and Schuster, 2004.

⁸¹ Patty Reinert, "Bush Admits Wanting New Iraq Regime Before 9/11," *Houston Chronicle*, January 13, 2004.

⁸² Thomas Ricks, in *Fiasco*, pp. 27–28, presents an alternative view to that of Paul O'Neill. Ricks quotes Patrick Clawson, whom he identifies as "a Middle East expert who moved in Washington's neoconservative circles (p. 27), as saying "What O'Neill doesn't notice is that those who wanted to go to war lost, and those who supported 'smart sanctions' won." There really was not a war party inside the Bush administration before 9/11, Ricks concludes. Furthermore, according to Clawson, the President's national security advisor at the time, Condoleezza Rice, made it "extremely clear" to colleagues that they weren't going to do anything in Iraq.

⁸³ Woodward, p. 21.

sure on Saddam that relied heavily on Iraqi opposition groups.⁸⁴ It is not clear what direction U.S. policy might have taken next, however, since 9/11 occurred before a formal policy recommendation was ever forwarded to the President.

The Global War on Terrorism

The terrorist attacks on September 11, 2001, marked a watershed in American history. Concerns about asymmetric attacks succeeding despite American military superiority suddenly took center stage.⁸⁵ Preventing another such attack became the primary focus of the U.S. government, and the manner in which it chose to pursue that goal would have worldwide ramifications. Over the next year, the administration developed a new national security strategy that was guided by two principal themes. The first was the concern over the potential use of chemical, biological, or nuclear weapons. The second was state sponsorship of terrorist groups such as al Qaeda.

Although the administration consciously focused on Afghanistan and al Qaeda following the 9/11 attacks, the concern over weapons of mass destruction meant that Iraq and other states thought to have such weapons did not move very far from center stage. Indeed, this concern helped lead to the doctrine of preemption. The assumption was that terrorist organizations were eager to obtain WMD and willing to use them. The attacks on the Pentagon and World Trade Center were bad enough. The United States could not afford to absorb a WMD attack. Thus, it would act to forestall such an attack in any way possible.

The doctrine of preemption would be explicitly laid out in President Bush's June 1, 2002, commencement address at West Point.⁸⁶ In outlining the new strategy, Bush argued that deterrence and containment were no longer sufficient. In particular, "Containment is not possible when unbalanced dictators with weapons of mass destruction can deliver those weapons on missiles or secretly provide them to terrorist allies."⁸⁷ Instead, "the war on terror will not be won on the defensive. We must take the battle to the enemy, disrupt his plans, and confront the worst threats *before* they emerge. In

⁸⁴ The Bush administration's reliance on the Iraqi National Congress, in particular, for intelligence helped to shape its view that U.S. troops would not face any serious resistance should they invade Iraq. In addition, the INC reinforced the belief of top U.S. officials that Iraq had active WMD programs.

⁸⁵ Although the 9/11 attacks were the primary impetus for change in the national security mindset of top U.S. officials, it was reinforced by other terrorist actions and threats, such as the 2001 anthrax incidents on Capitol Hill in Washington, D.C. and the revelation that an al Qaeda operative had been planning to set off a radiological bomb in a U.S. city.

⁸⁶ This was later formalized in White House, "The National Security Strategy of the United States," September 2002.

⁸⁷ President George W. Bush, "Remarks at 2002 Graduation Exercise of the United States Military Academy," June 1, 2002.

the world we have entered, the only path to safety is the path of action. And this nation will act.”⁸⁸

The new national strategy had several implications for the U.S. military. Targeting the regimes that offered support and sanctuary to terrorists, as well as the terrorist networks themselves, meant that military action would constitute a significant part of the global war on terrorism. That was clearly demonstrated by Operation ENDURING FREEDOM in Afghanistan. The new strategy also required a significant rethinking of all U.S. warplans, which Secretary of Defense Rumsfeld found inadequate in light of 9/11. The doctrine of preemption also implied greater potential for the use of military force. Furthermore, given the link to states that supported terrorism, the doctrine also implied military activity in areas where traditionally the United States lacked experience or presence.

The months before the war in Iraq involved intense diplomatic activity both at the UN and between embassies. The diplomatic effort to achieve a second UN resolution explicitly authorizing force failed, and this outcome had several implications for military planning and operations in OIF. First, lacking the legitimacy of a UN mandate, many Arab states that had sided with the United States in the first Gulf War either withheld their support for OIF (e.g., Egypt and Syria) or chose to provide only limited support for the war (e.g., Saudi Arabia and Jordan). Within the Arab world, only the small and militarily vulnerable Arab Gulf States unconditionally backed the U.S.-led invasion of Iraq in 2003. Although many Arab regimes welcomed the removal of Saddam, internal pressures made open support without UN approval politically impossible.

The ultimate effect on operations of the failure to pass a second UN resolution was mixed. On the one hand, Turkey’s veto over U.S. military access to Iraq from the north created the need for additional planning, involving different force deployments and logistical constraints (e.g., the 4th Infantry Division [ID]), which was to have invaded Iraq from the north by passing through Turkey, had to redeploy to Kuwait and invade from the south, later than originally planned), and affected operations in northern Iraq. On the other hand, support and access from states like Kuwait, Qatar, and Saudi Arabia, although sometimes provided in secret, allowed the smooth buildup of forces that the United States would deem necessary to launch major combat operations in mid-March 2003 and to sustain them through April and beyond.

The lack of a UN coalition caused further problems, given that the objective in Iraq was regime change. As it turned out, this objective would lead to a prolonged period of occupation. In such a situation, having secured UN support in advance might have eased the military and financial burden on the United States, for example by providing political cover that might have enabled or induced certain countries to contribute more to the occupation effort. In addition, it might also have weakened

⁸⁸ Bush, emphasis added.

some of the anti-American resentment within Arab and Muslim communities—to the extent that such resentment grew out of the U.S.-led invasion of Iraq.⁸⁹

⁸⁹ Although leaders in Paris and Berlin, in particular, had strong domestic political reasons for opposing the invasion of Iraq, intemperate remarks delivered in public by American and European officials made it difficult for diplomats working behind the scenes to arrive at a mutually acceptable resolution of the Iraq crisis. For an extended analysis of the diplomatic dispute among the United States, France, Germany, Russia, and Turkey before the 2003 Gulf War, see Phillip H. Gordon and Jeremy Shapiro, *Allies at War: America, Europe, and the Crisis over Iraq*, New York: McGraw-Hill, 2004.

Planning the War and the Transition to Peace

Walter L. Perry

Unlike the effort for Afghanistan, planning for Operation IRAQI FREEDOM enjoyed the advantage of approximately 12 years of intense focus on the Persian Gulf region.¹ At the close of the 1991 Gulf War, Operations Plan (OPLAN) 1003 was developed to eject Saddam from Kuwait in the event that he tried to occupy it again. In 1998, then CENTCOM commander General Anthony Zinni developed OPLAN 1003-98 to deal with Saddam's possible obstructions of the United Nations Special Commission (UNSCOM).²

Although neither the original plan nor General Zinni's modification focused on regime change, the knowledge gained from exercising those plans through simulations, wargames, and exercises was invaluable in developing the ultimate plan for OIF. In addition, a second war in Southwest Asia was part of the military's force planning construct, which envisaged fighting two major theater wars simultaneously and prompted several additional studies that gave CENTCOM an edge in planning for this war.³ Finally, the no-fly zones enforced by SOUTHERN WATCH and NORTHERN WATCH not only weakened Saddam's air defenses, they also provided CENTCOM planners with considerable intelligence to support their planning.

The Warplan Evolves

On November 27, 2001, the Secretary of Defense directed CENTCOM to develop a plan that would forcibly remove Saddam Hussein from power.⁴ In proceeding to change

¹ This chapter is based on research documented in Nora Bensahel, Olga Oliker, Keith Crane, Richard R. Brennan, Jr., Heather S. Gregg, Thomas Sullivan, and Andrew Rathmel, *After Saddam: Prewar Planning and the Occupation of Iraq*, Santa Monica, Calif.: RAND Corporation, MG-642-A, 2008.

² This is the plan General Franks referred to as the "heavy bookend" in his war planning because of the number of troops required to support it. Joseph Galloway, "General Tommy Franks Discusses Conducting the War in Iraq," Knight Ridder, June 19, 2003.

³ The force planning construct called for the U.S. military to be capable of conducting two major regional conflicts simultaneously. The two generally cited were Southwest Asia and North Korea.

⁴ Tommy Franks, *American Soldier*, New York: Regan Books, 2004, p. 315.

the then-current plan in response to the guidance received from Secretary Rumsfeld in November, General Tommy Franks, commander of CENTCOM, argued:

The existing plan, OPLAN 1003, had last been updated after Desert Fox in 1998, but it was based on Desert Storm—era thinking. It was troop heavy, involving a long buildup and a series of air strikes before boots hit the ground. It didn't account for our current troop dispositions, advances in Precision-Guided Munitions, or breakthroughs in command-and-control technology—not to mention the lessons we were learning from Afghanistan.⁵

On December 7, 2001, General Franks presented Secretary Rumsfeld with the first iteration of his Commander's Concept of Operations. By the time Franks's new OPLAN, termed *1003V*, was finished, it grew to 89 pages, with thousands of pages of specialized appendixes.

Minimizing Collateral Damage

Of deep concern to the President and his advisors was the effect of combat operations in Iraq on civilian casualties. Consequently, planners at CENTCOM spent considerable time estimating the number of noncombatant casualties expected for each target on the initial target list.

Assessing the expected number of casualties and the general destruction resulting from striking targets has grown into a complex industry within military planning organizations. Planning for OIF was no exception. From early in the planning process, tension existed between the need to destroy military targets (in support of the war effort) and the humanitarian and economic desire to limit noncombatant casualties and extensive damage to infrastructure (in support of postwar reconstruction). Although precision munitions helped to minimize the negative effects of bombing, they did not eliminate them. Heavy reliance was placed on intelligence estimates and the development of sophisticated software packages. The former focused on pinpointing the military target's exact location in a building, whereas the latter calculated the expected blast radius if that location were struck with a precision munition.

Lines and Slices

Early in the iterative process of developing his Commander's Concept, General Franks limited participation to a small number of officers from his planning, intelligence, and operations staff. By December 8, 2001, he had developed a working matrix that highlighted what he called "lines and slices." The slices can best be understood as centers of gravity or target sets he wanted to affect, while the lines were the means he would use

⁵ Franks, p. 329.

against particular targets. Together they represent what General Franks considered to be the primary focus areas of the operation.

The “lines and slices” are depicted in Figure 3.1. This matrix demonstrates that, even at this early stage, Franks was envisioning a plan that focused not only on defeating the Iraqi military and removing Saddam Hussein from power, but also on doing it in a way that achieved his overall strategic goals, particularly as these related to the Iraqi population. According to Franks, the challenges associated with the “day after the war” were being considered early in the planning process.⁶

On December 28, 2001, General Franks briefed his Commander’s Concept to President Bush and identified four major phases of operations. Each phase had a specific endstate to be achieved before moving to the next phase. Phase I included establishing international support and creating an “air bridge” that would be needed to transport forces and capabilities into the theater. Phase II was designed to “shape the battlespace” before ground operations were initiated. Phase III had two primary goals: “regime forces defeated or capitulated” and “regime leaders dead, apprehended, or marginalized.”

Figure 3.1
Lines and Slices

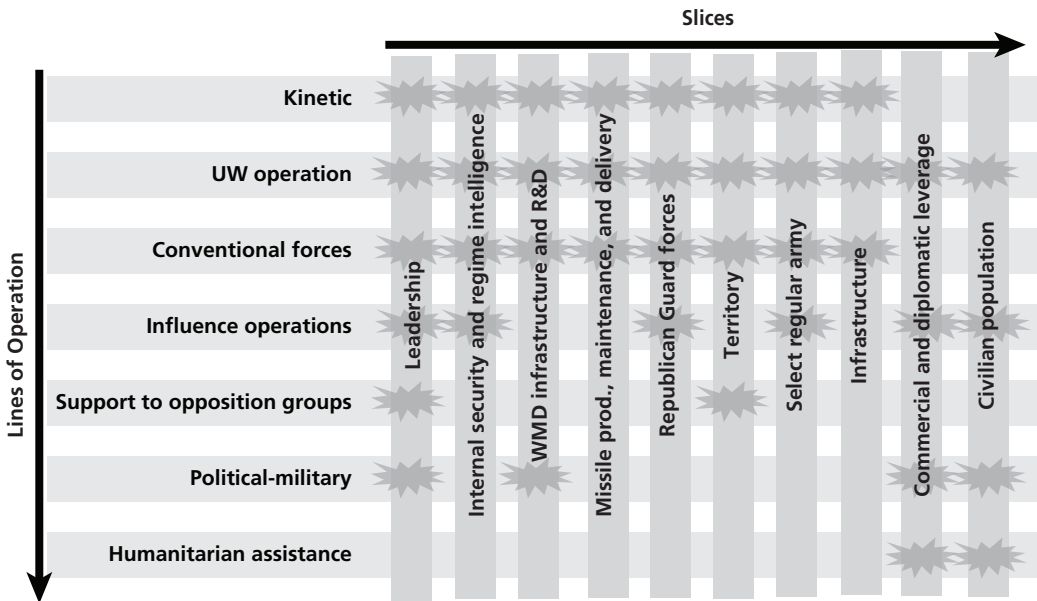

SOURCE: Tommy Franks, *American Soldier*, New York: Regan Books, 2004, p. 340.

RAND MG641-3.1

⁶ Franks, pp. 340–341. The “lines and slices” matrix developed by General Franks in December 2001 remained the foundation for campaign planning for OIF. As late as April 2003, Combined Forces Land Component Command (CFLCC) referenced a more refined variant of this template when it published a draft of OPLAN ECLIPSE II, the CFLCC plan for transitioning to Phase IV (post-hostility operations).

Finally, Franks briefed his overarching concept for Phase IV, “post-hostility operations,” arguing that this phase would be the longest—“years, not months”—in duration. In fact, the briefing chart used to discuss Phase IV split the arrow representing a timeline into segments and identified its duration as “unknown.” The endstate for Phase IV operations was identified as “the establishment of a representative form of government, a country capable of defending its territorial borders and maintaining its internal security, without any weapons of mass destruction.”⁷ While many details had yet to be resolved, the President approved the overarching concept of a four-phased campaign.⁸

A Generated or Running Start?

The initial planning concept called for a generated start force, i.e., forces were to be built up to a level considered sufficient to execute the plan, and all lines of operation called for in the plan (e.g., air and ground, naval, SOF, information operations, etc.) were to be employed simultaneously. General Franks described the concept as “a blueprint for ‘generating’ the necessary ground, air and naval presence in the region that would enable us, at the orders of the President, to commence decisive military operations to meet the Endstate objective of REGIME CHANGE” [emphasis in original].⁹

As early as January 2002, however, planners began to speculate about what would happen if the enemy decided to start the war on its own schedule—that is, before the fully generated force was in place. Plans were then developed to ensure that coalition forces could respond to any enemy provocation with whatever forces were available at that time. In a briefing to Secretary Rumsfeld that took place in January 2002, Franks put it this way:

Mr. Secretary, there are only two ways to go to war. Either the enemy starts it on his schedule—or we start it on ours. Since we do not have a decision to go to war on our timeline, we need options in case Saddam starts one on his timeline. I like the idea of a “running start” as an option. We continue to build forces and infrastructure in the region to support diplomacy. And if the President makes the decision to attack, we will begin with what we have and follow on—as long as necessary, with as much force as necessary.¹⁰

⁷ Franks, p. 351.

⁸ The briefing prepared for the President did not include a discussion of phasing. However, after General Franks concluded his briefing, Secretary of State Colin Powell asked a question that resulted in the need to refer to backup slides detailing CENTCOM’s phasing concept. It was not until Franks’s February 3, 2002, briefing to the President that these slides on phasing made their way into the formal briefing.

⁹ Franks, p. 361.

¹⁰ Franks, p. 363.

On January 7, 2002, General Franks assembled his small group of planners engaged in compartmentalized planning and charged them with developing “running start” options in the event that President Bush decided to initiate an attack in response to action taken by Iraq.

For the next three months, a handful of officers on the CENTCOM staff continued to plan for all four phases of OPLAN 1003V. As the Commander’s Concept matured it eventually involved a five-pronged attack with ground forces simultaneously advancing into Iraq from Kuwait and Turkey, special operations forces (SOF) moving into the western desert areas to prevent short-range ballistic missiles from being employed, a comprehensive information and psychological operations (PSYOP) “front” being launched to erode the resolve of the Iraqi military, and an operational fires attack targeting Baghdad and the Republican Guard forces defending the city. At this point in the planning process, Phase III was expected to take up to 135 days. According to General Franks, it was envisioned that troop levels would continue to increase during Phase IV with “as many as two hundred and fifty thousand troops” needed to accomplish the endstate objectives.¹¹ However, the reality was that commanders in the field planned to stay in Iraq for no more than three or four months after the end of major combat operations.¹² For this reason, units did not order spare parts in sufficient quantities to support a prolonged stay.¹³

It was not until March 21, 2002, that General Franks met with his component commanders for the first time to discuss the “shape and scope” of a potential military operation against Iraq. While the compartmentalized nature of the planning process continued, small planning staffs for each of the components were established to begin working in parallel on their supporting OPLANs. By June, Franks was ready to brief a running start plan to the President. He presented that briefing on June 19, 2002.

Weapons of Mass Destruction

Countering the WMD threat was a primary concern in the planning process. However, the June 19 briefing to the President is the first time a discussion of plans to deal with WMD was presented to him. The presentation began with an assessment of what nuclear, biological, and chemical weapons and facilities Iraq was thought to possess. This was followed by proposed plans to: (1) deter their use; (2) protect friendly forces and regional partners; (3) attack Iraqi capabilities; and (4) mitigate the effects if WMD were used.

¹¹ Franks, pp. 361–363, 366, and 376–377.

¹² “Administration officials had hoped to shrink the U.S. military presence to two divisions . . . by the fall of 2003.” Bensahel et al., *After Saddam: Prewar Planning and the Occupation of Iraq*, 2008. This is based on an interview with a V Corps official in January 2005.

¹³ See Chapter Nine for details on sustaining the force.

- **Chemical weapons.** Iraq was thought to possess several tons of nerve agents located in various production sites. Concern was that the Iraqis might deploy these agents forward to attack coalition forces.
- **Biological weapons.** Among the biological agents Iraq was thought to possess were anthrax, botulinum toxin, gas gangrene, ricin, and smallpox. Planners speculated that these agents were scattered among several research and development sites and mobile production laboratories. Like the chemical weapons, the fear was that these weapons might be deployed forward to attack coalition forces.
- **Nuclear research.** Curiously, there was no suggestion that Iraq had nuclear weapons, but that they were likely continuing nuclear research in several research and development facilities throughout Iraq.

In addition to Iraq's suspected WMD capability, the presentation discussed Iraq's ability to deliver these weapons. Several delivery means were suggested, to include spraying biological weapons from aircraft or unmanned aerial vehicles (UAVs) and delivering chemical weapons by artillery, ballistic missiles, and other rocket systems. There was no suggestion that the Iraqis were capable of delivering nuclear weapons, however.

The “deter, protect, attack, and mitigate” plans were a mixture of tactics, techniques, and procedures, direct intervention, training, equipment, and reconnaissance measures. The following details the approach suggested by the planners:

- **Deter.** The briefing suggested that the coalition would use a full range of options to deter WMD use by the Iraqis. These included information operations to dissuade the Iraqi military from using these weapons; direct action and strategic reconnaissance by SOF units against suspected launch sites; and assurance that the coalition forces were trained and ready to defend against WMD use. The briefing emphasized that WMD would not halt combat operations.
- **Protect.** Protection measures for the coalition and regional partners included Patriot missiles and counter battery radars; the deployment of chemical units early in the flow of forces to the theater; certain passive measures such as individual protective equipment, hardened facilities, and dispersal of forces to minimize the effect of chemicals; WMD warning and reporting systems; and anthrax immunizations.
- **Attack.** Plans were to place likely WMD facilities on the target list to be attacked early in the air campaign. These included suspected missile production and storage facilities, chemical production facilities, biological and nuclear research facilities, tactical rocket units, ammunition caches, and command and control sites.
- **Mitigate.** Finally, plans were made to mitigate the effects of WMD if they were employed. This consisted of the deployment of crisis management forces trained

to deal with WMD effects; employ decontamination procedures; and publicize the attack to generate world support.

Emergence of the Hybrid Plan

After detailed analysis and examination, the generated start and the running start plans were both found wanting. Although the generated start plan promised an adequate force in place that would allow for simultaneous application of the lines of operation, it would take a long time to get it there, thus delaying the start of combat operations. The running start plan promised quicker deployment, but it required operations to begin before the full force was present, thereby entailing a more sequential application of the lines of operation.

What ultimately emerged from the planning process, to be briefed to the President on August 5, 2002, was a four-phase, so-called “hybrid” plan that provided for a relatively short combat phase. Although this plan consisted of elements from both the generated start and running start plans, it more closely resembled the running start plan. The concern, however, was that the running start plan, although promising a faster start, compromised on force capability. What was desired was a plan that not only could be executed swiftly, but could also provide a larger force early on. The hybrid plan promised both. General Franks had this to say about the hybrid plan:

The initial deployment in Phase I would be greatly accelerated by massive air-lift, using the Civilian Reserve Air Fleet to augment our military transport capabilities. Tens of thousands of troops would be moved to the war zone within a week. And less than two weeks later they would be matched up with their equipment, which would be shipped by sea. This buildup of forces would be protected by a combat air umbrella of eight hundred strike aircraft from carriers and land bases around the Gulf. In Phase II, we would launch air and Special Operations Forces into Iraq for about two weeks to destroy key target sets and set conditions for deploying heavy units. Then the heavy units would launch their operations in Phase III, which could last up to ninety days, and would complete the destruction of the Iraqi military.¹⁴

A variant of this plan was essentially the one that was ultimately approved for execution on February 13, 2003.

Table 3.1 summarizes the three plans. The numbers below the plan name indicate the number of days in Phases I, II, and III each plan called for. For the generated start plan, the first number combines Phases 0 and I. The plans were sometimes referred to by these triplets.

¹⁴ Franks, p. 390.

Table 3.1
Comparing the Plans

Plan	Phase 0	Phase I	Phase II	Phase III	Phase IV
Generated 90-45-90	Planning and decisionmaking: 30 days	Complete posturing of initial force: 60 days	Attack the regime: 20-45 days	Complete regime destruction: 90 days	Post-hostilities: over one year
Running start 45-90-90		Shape the battlespace: 45 days	Decisive offensive operations: 60-90 days	Complete regime destruction: 90 days	Post-hostilities: unknown duration
Hybrid 16-16-125		Preparation: 16 days	Shape the battlespace: 16 days	Decisive offensive operations: 125 days	Post-hostilities: unknown duration

The final plan for combat operations in Iraq resolved two competing objectives. On the one hand, policymakers wanted to attack quickly. They believed that a protracted buildup of forces, like the one that occurred during the first Gulf War, would cede the initiative to the Iraqis. They were concerned that the Iraqis would then take actions that could greatly complicate the attack or, in the worst case, bog it down and force the coalition to commit substantially greater forces. On the other hand, policymakers did not want to commit a force to war that was insufficient for the task at hand. If the Iraqis could blunt the initial attack, they might be able to isolate part of the attacking force and defeat it in detail. The United States would then confront the choice of withdrawing forces or sending in substantial reinforcements, both equally unpalatable options. Inevitably, casualties would rise, eroding support for the war both at home and abroad.

In the end, the final phased plan was as depicted in Figure 3.2. The time allotted for the decisive offensive operations component of major combat operations (Phase III) was not specified. In addition, the size of the force available was considerable, at approximately 290,000, which included all U.S. and coalition forces. The shortened preparation and shaping phases were due, in part, to: (1) the buildup of forces in the area by mid-February 2003; and (2) relaxed rules of engagement for Operations NORTHERN and SOUTHERN WATCH as the beginning of hostilities approached.

Planning for the Aftermath

On August 5, 2002, when Franks briefed President Bush and the National Security Council (NSC) on the hybrid plan, what had begun as a concept nine months earlier had now become a full campaign plan. The expected length of major combat operations had been shortened to 90 days, but the time required to meet post-hostility objec-

Figure 3.2
The Final Plan

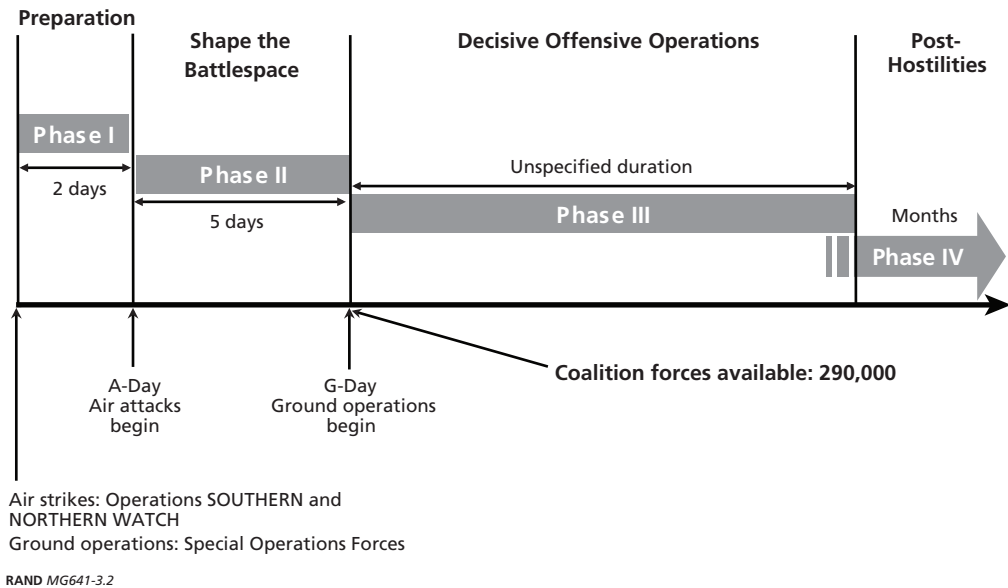

tives remained indeterminate. Franks raised what he called the potential for “catastrophic success,” which would occur if the Iraqi military resistance fractured early in the campaign, if a military coup toppled Saddam Hussein, or if Shi’ite and Kurdish rebellions occurred in Iraq.¹⁵ He expressed particular concern about the potential for lawlessness and violence in the immediate aftermath of military operations but unfortunately failed to plan to deal adequately with such a threat. There was wide agreement within the NSC that if this occurred, coalition forces would continue with the campaign plan until order was restored and the Iraqis were able to govern themselves.

At the conclusion of the briefing, Franks emphasized that he envisioned having a maximum of 250,000 coalition troops in Iraq at the end of major combat operations. These forces would be necessary to help create a new Iraqi military and establish a constabulary force.¹⁶ Franks further stated that “well-designed and well-funded recon-

¹⁵ Franks, pp. 380–393.

¹⁶ It is unclear how it was determined that 250,000 troops would be sufficient for the tasks likely to be required in a postwar Iraq. As will be discussed later, U.S. military experience in postwar situations in Bosnia and Kosovo suggest that postwar operations require a ratio of 20 soldiers for every 1,000 inhabitants. With an Iraqi population of 25 million, historical experience suggests that a minimum of 500,000 soldiers would be required. That number is in addition to the numbers of police, gendarmerie, and carabinieri units that would be of vital assistance in maintaining public order. For a more detailed analysis of this subject, see James Dobbins et al., *America’s Role in Nation-Building: From Germany to Iraq*, Santa Monica, CA: RAND Corporation, MR-1753-RC, 2003, pp. 149–153.

struction projects that put large numbers of Iraqis to work and quickly meet community needs—and expectations—will be the keys to our success in Phase IV.” He made it clear that it was important to enable Iraqis to gain control of their own governance as soon as possible. Significantly, Franks told President Bush that the U.S. exit strategy had to be linked to effective Iraqi governance rather than to any artificial timeline, a conclusion not challenged by any member of the NSC.¹⁷

A Late Start at CENTCOM

Initial concepts for post-hostility operations were fairly vague. By the time the President approved OPLAN 1003V on February 13, 2003, the operational conduct of Phase I was virtually complete. The final version of the operations plan provided guidance and responsibilities for post-hostility operations. Because Combined Forces Land Component Commander (CFLCC) was designated as the supported command during post-combat operations, a more detailed plan for Phase IV operations, including an annex for stability operations, was contained in its supporting OPLAN, COBRA II (see below).¹⁸

Formal planning for post-hostility operations continued both at CENTCOM and CFLCC throughout the execution of major combat operations and continued into the post-hostilities phase. For example, in February 2003, planners at CFLCC determined that the base plan might cause the rapid collapse of the Iraqi military, resulting in a swift advance toward Baghdad. They further concluded that if the ground forces seized Baghdad as quickly as they now thought possible, coalition forces would not be in position to easily transition to Phase IV operations. Consequently, CFLCC prepared and published a sequel, OPLAN ECLIPSE II (see below), in April 2003.¹⁹ At the same time, in parallel to the planning conducted by CFLCC for OPLAN ECLIPSE II, CENTCOM was developing its own revised plan for post-hostility operations, OPLAN IRAQ RECONSTRUCTION.

General Franks and his planning staff had numerous discussions about what a postwar Iraq might look like and what type of interim political government might best be established. While members of his staff argued that rebuilding the infrastructure could not take place without security, Franks believed that security would not be achieved without reconstruction and civic action. There was, however, wide agreement that the two issues were inextricably linked.²⁰

CENTCOM assumed it would help the interim government establish a paramilitary security force that would be drawn from some of the better units of the defeated

¹⁷ Franks, pp. 392–393.

¹⁸ CFLCC, Change 2 to “CFLCC OPLAN COBRA II, Base Plan (13 JAN 02),” February 15, 2003.

¹⁹ COL Kevin Benson, CFLCC C-5, interview with the author, August 2004.

²⁰ Franks, pp. 422 and 424.

Iraqi army. It was envisioned that these units would work in conjunction with coalition military forces to help restore order and prevent armed conflicts among ethnic, religious, or tribal factions. Franks concluded that “this model had been used effectively in Afghanistan,” and CENTCOM planners believed it was the best solution they had to the challenge of providing security in the immediate aftermath of major combat operations.²¹ Questions remained, however, about the effectiveness of the Afghanistan model, especially outside Kabul, and whether that model would work in a country that is largely urbanized, has clear fault lines among three major ethnic and religious groups, and would have no clear successor government.

Planning for post-hostility operations, however, was never a high priority at CENTCOM. In a March 29, 2002 briefing to the President on the warplan, some mention was made of tasks or “actions” to be performed once hostilities ceased. Other briefings barely mentioned post-hostility operations—grouped together in Phase IV, to distinguish them from the major combat operations being conducted in Phase III of the warplan—except to provide an estimate of its likely duration. Even so, it appears that planners became less and less certain of Phase IV’s duration as time went by. Thus a one-year-plus estimate made in early February 2002, when the generated start plan was briefed, quickly became “unknown duration” and remained that way through the August 5 briefing on the hybrid plan discussed above.

General Franks claims in his book that Phase IV was discussed throughout the planning for OPLAN 1003V. He includes several references to conversations about Phase IV planning with Secretary Rumsfeld. As early as December 12, 2001, Franks urged him to “begin the interagency work that will be necessary with State and the intelligence [sic] community.”²² In his December 28 briefing to the President, General Franks admitted that Phase IV “might well prove more challenging than major combat operations.” He added that Phase IV operations would draw on information as well as political-military operations, humanitarian assistance, NGO involvement, and sensitive WMD site exploitation.²³ Curiously, in early February in a briefing to Secretary Rumsfeld, Franks suggested that when Phase IV operations commenced, forces would continue to grow as high as 250,000 troops, despite charts in later briefings suggesting that force levels might be reduced in Phase IV.²⁴ In fact, Franks quotes himself as saying to the President during a May 11 meeting that:

²¹ Franks, p. 419.

²² Franks, p. 344.

²³ Franks, p. 352.

²⁴ Franks, p. 366.

At some point, we can begin drawing down our force. We'll want to retain a core strength of at least fifty thousand men, and our troop reductions should parallel deployment of representative, professional Iraqi security forces.²⁵

Finally, Franks sums up his Phase IV efforts by writing that he and his staff discussed Phase IV (what he called the “day after”) throughout the planning process. He says that they considered both Europe after World War II and Afghanistan in the wake of ENDURING FREEDOM as potential models for Iraq post-OIF. In this context, Franks claims that:

We considered the pros and cons of senior U.S. Army and Marine Corps officers and British military commanders working with Iraqi tribal sheiks all across the country. And we studied the feasibility of an interim government in Iraq formed with international support, along the lines of Hamid Karzei's administration in Afghanistan.²⁶

CFLCC Planning for Post-Hostility Operations

As specified in OPLAN 1003V, CFLCC was designated as the supported command for stability operations. Lieutenant General David D. McKiernan, the commander of the U.S. Third Army, which had been designated the CFLCC, was informed of his responsibilities for Phase IV when the Third Army was directed to begin planning in December 2001, just days after General Franks met with President Bush at Crawford, Texas. Shortly after receiving the mission, Lieutenant General McKiernan selected Colonel Kevin Benson to be the Deputy Chief of Staff for Civil-Military Operations. Benson was given authorization to be “read into” Polo Step, a special access program for planning, and given access to the developing warplans.²⁷ He immediately concluded that CFLCC needed to put more emphasis on Phase IV planning and, consequently, spent the next two months making contact with people—inside both government and academia—who were involved in projects that examined issues associated with postwar Iraq.²⁸

Colonel Benson also led a group of strategic planners who developed CFLCC's supporting plan for OPLAN 1003V—called OPLAN COBRA II. From the very beginning, COBRA II was an all-inclusive plan that addressed all aspects of the ground campaign, beginning in Phase I and continuing through Phase IV redeploy-

²⁵ Franks, p. 393.

²⁶ Franks, p. 419.

²⁷ The term *read into* refers to the practice of allowing personnel with a “need to know” to read and use compartmentalized classified material.

²⁸ Benson interview, August 2004.

ment. During the first few months, however, access to OPLAN 1003V was limited to a handful of senior officers at CFLCC. Consequently, the CFLCC planning team was constrained in its efforts to build a comprehensive supporting plan.²⁹ In October 2002 the classification of OPLAN 1003V was downgraded to Secret, and a larger number of the CFLCC planning staff gained access.

As CFLCC started to ramp up for the possibility of war, the size and composition of its staff, including the planning staff, grew. By January 2003, thirteen graduates from the Army's School of Advanced Military Studies had been assigned to the CFLCC planning staff because of their unique skills.³⁰ In fact, the Army transferred many of these officers from other duty assignments well in advance of their normal rotation dates specifically because of their schooling.³¹

During a series of wargames for COBRA II, CFLCC officials concluded that they needed to develop a sequel plan in case the endstate envisaged in COBRA II did not materialize. The sequel that they drafted, called OPLAN ECLIPSE II, contained what turned out to be a more accurate appraisal of the potential security challenges in the postwar period. However, it did not challenge some of the fundamental assumptions of COBRA II. As a result, military resources were allocated based upon a "too optimistic" view of the security situation during the transition from major combat operations to post-hostility operations.

Task Force IV

In December 2002, observers at CENTCOM's Internal Look exercise noted that the warplans for Iraq did not include detailed planning for the postwar period, instead focusing on Phases I through III.³² General discussion about the postwar period concluded that the State Department would largely be responsible during that time. Retired General Gary Luck, the senior advisor during the exercise, commented that the military needed to stand up a planning cell to fill this gap in the planning, and to start coordinating with the other U.S. government agencies, international organi-

²⁹ This is a common occurrence in the development of OPLANs.

³⁰ Benson interview, August 2004. The School of Advanced Military Studies educates and trains officers at the graduate level in military art and science to develop commanders and general staff officers with the abilities to solve complex problems in peace and war.

³¹ Lieutenant Colonel Steven W. Peterson, "Central but Inadequate: The Application of Theory in Operation Iraqi Freedom," a paper presented in partial completion of the course of study at the National Defense University, 2004, p. 3.

³² Internal Look is an annual CENTCOM exercise that does not always focus on Iraq. The 2002 version, held between December 8 and 17, was used to exercise the developing warplans for Iraq. Daniel Williams and Vernon Loeb, "At Qatar Base, U.S. Begins a Test Run for War," *Washington Post*, December 10, 2002; Woodward, pp. 237 and 244; Scarborough, p. 176.

zations, and NGOs.³³ Later that month, the Chairman of the Joint Chiefs of Staff (CJCS) ordered Joint Forces Command to create a new organization, based on the Standing Joint Force Headquarters (SJFHQ) concept that would plan for Phase IV and form the nucleus of a postwar military headquarters in Iraq. This new organization, called Task Force IV (TFIV), was placed under CENTCOM's operational control and started assembling in Tampa in January 2003.³⁴

The task force, commanded by Brigadier General Steven Hawkins, attempted to produce detailed plans for the postwar period, particularly in preparation for its role as a military headquarters, but its requests for political guidance from the interagency community often went unanswered. It also tried to learn more about the joint planning process and the SJFHQ concept, since this was the first time it had ever been put into practice.³⁵

Planning

TFIV did not receive any formal planning guidance, so its members relied heavily on public statements by key administration officials, in particular the testimony that Douglas Feith, the Under Secretary of Defense for Policy, provided to the Senate Foreign Relations Committee on February 11, 2003.³⁶ In his testimony, Feith outlined five specific objectives of the postwar period:

- To “demonstrate to the Iraqi people and the world that the United States aspired to liberate, not occupy or control them or their economic resources”;
- To “eliminate Iraq’s chemical and biological weapons, its nuclear program, the related delivery systems, and the related research and production facilities”;
- To “eliminate likewise Iraq’s terrorist infrastructure”;
- To “safeguard the territorial unity of Iraq”;
- To “begin the process of economic and political reconstruction, working to put Iraq on a path to become a prosperous and free country.”³⁷

Initially, TFIV planners focused on how they would organize themselves and how they would assess the power grid, water supplies, government structures, and secu-

³³ Interview with Task Force IV official, March 2004.

³⁴ For more on the SJFHQ concept, see U.S. Joint Forces Command, *Doctrinal Implications of the Standing Joint Force Headquarters (SJFHQ)*, Joint Warfighting Center Joint Doctrine Series, Pamphlet 3, June 16, 2003; and Colonel Douglas K. Zimmerman, “Understanding the Standing Joint Force Headquarters,” *Military Review*, July–August 2004, pp. 28–32.

³⁵ Interviews with TFIV officials, March and April 2004.

³⁶ Interview with TFIV official, March 2004.

³⁷ Douglas J. Feith, Prepared Statement submitted to the U.S. Senate Committee on Foreign Relations, February 11, 2003.

rity needs that would form the baselines for their work. TFIV then addressed many substantive topics, including food distribution, infrastructure maintenance, and what to do with the Iraqi army after the war.³⁸

They also planned extensively for the military headquarters that would conduct post-conflict operations. The plans called for TFIV to expand through augmentation into a fully functional coalition headquarters called the Combined Joint Task Force Iraq (later renamed CJTF-7). TFIV planned for CJTF-Iraq to divide Iraq into seven sectors, each commanded by a two-star general.

Based on a troops-to-task analysis, TFIV concluded that CJTF-Iraq would require at least 90 battalion equivalents. When the requisite headquarters, maintenance units, hospitals, and other support structures were added to this combat force, TFIV estimated that CJTF-Iraq would require a minimum of approximately 200,000 U.S. military personnel and most likely more.³⁹

TFIV identified ten key policy issues that remained unaddressed. On February 21, 2003, TFIV briefed the CFLCC on the areas for which it needed more interagency guidance, so that the request could be submitted up the chain. The ten issues were:

1. Under what mandate will the transitional civil authority and coalition forces be operating? Is there a specific UN mandate for civil and military authority?
2. What will be the coalition policy toward surrender and capitulation? Will there be a national ceasefire agreement?
3. Who sets vetting policy? Who does the vetting? How quickly can it be done? What will be the criteria for criminal referral, government employment, police service, border guard service, and military service?
4. What is coalition policy on disarming Iraqi military, security, and police forces? What is coalition policy on suspension and reactivation of the Iraqi military?
5. What is the policy on return of internally displaced persons (IDPs) and refugees?
6. What Iraqi political, ethnic, and opposition groups will be allowed to participate in the interim government?
7. What legal system will Iraq be under during coalition control?

³⁸ TFIV's recommendations on the Iraqi army paralleled the guidance subsequently issued by the National Security Council. TFIV advocated removing the top two or three levels of the army command structure, leaving the rest of the soldiers in garrison, and gradually using the units to rebuild roads and to undertake other reconstruction tasks. Interview with TFIV official, April 2004.

³⁹ In late February 2003, General Eric Shinseki, then the Army Chief of Staff, asked Task Force IV for its estimates on how many troops would be required for postwar operations. Shinseki was told that depending on initial conditions, anywhere between 300,000 and 500,000 troops would be needed. These figures were similar to those generated by Shinseki's staff and helped form the basis for his congressional testimony that "something on the order of several hundred thousand soldiers" would be required for postwar operations in Iraq. Note that these figures were higher than the 250,000 troops that General Franks had estimated. Interviews with TFIV officials, March and June 2004; General Eric Shinseki, testimony to the U.S. Senate Armed Services Committee, February 25, 2003; Franks, pp. 366 and 393.

8. What currency or currencies will be legal tender?
9. What is the funding mechanism? Who controls funds at the national, regional, and local levels?
10. What should coalition forces do with Iraqi prisons and prisoners?⁴⁰

TFIV did not receive any feedback on these questions; the interagency community was in the process of formulating guidance on many of these issues.

Operational Challenges

Task Force IV faced several bureaucratic and organizational challenges during its ten-week existence. These include:

- **Staffing issues.** Staffing for TFIV occurred on an ad hoc basis; the SJFHQ concept, however, presupposes a permanent organization formed well in advance of any crisis. The Services provided personnel fairly quickly, but often they were unable to supply people with relevant planning or regional experience. Questions also arose about whether the leaders of TFIV possessed the rank and experience necessary for their positions, since the CJCS message specified that this organization would be led by a brigadier general.⁴¹
- **Relations with CENTCOM and CFLCC.** Part of the reason for the tensions between TFIV and the unified commands was structural: since it had been established by the Joint Staff, CENTCOM and CFLCC both viewed TFIV as an outside organization providing no added value.
- **Relations with the Office of Reconstruction and Humanitarian Assistance (ORHA).** TFIV and ORHA never developed an effective working relationship, though they were working on related aspects of postwar planning. Cooperation suffered from their failure to collocate and their mutual lack of robust communications. ORHA established itself as the main postwar planning organization, and TFIV was increasingly marginalized over time.⁴²

The Dissolution of Task Force IV

Task Force IV deployed in late January 2003 from Tampa to Kuwait and was placed under the operational control of the CFLCC. The CJCS, in ordering its creation, had intended it to be the nucleus around which post-hostility operations would be planned and executed. But by the time the task force arrived in theater, CFLCC had already

⁴⁰ “Resourcing Nation Building,” Task Force IV briefing to the CFLCC, February 21, 2003.

⁴¹ CJCS Execute Order, 10 January 2003, Section 6.

⁴² ORHA is discussed in detail in Chapter Eight.

done considerable planning for post-conflict operations, and there was considerable confusion over exactly what this new headquarters would do.⁴³

The planners at CFLCC envisioned that TFIV would only assume responsibilities for post-hostility operations after the CFLCC redeployed to the United States—essentially limiting its involvement to recovery and transition to security operations planning. However, the commander of TFIV believed he was given full responsibility for all post-hostility planning as well. As a result, the CFLCC for Strategic Planning and Policy (C-5) and TFIV conducted parallel planning for the same mission, although there was little coordination between the two planning staffs. As a result, as late as mid-February 2003, the exact role of TFIV was undefined. While the task force was said to be in “direct support” of what was being called Combined Joint Task Force Iraq (CJTTF-Iraq),⁴⁴ the details of that support were never specified.⁴⁵ On February 15, 2003, Lieutenant General McKiernan was presented with two options for employing TFIV: embedding it within a three-star headquarters or building a three-star headquarters around it. The ultimate decision was neither: TFIV was disbanded and the mission was assigned to V Corps.⁴⁶

A Plan Without Resources

Post-hostility operations planning continued in CFLCC throughout January 2003. On February 15, CFLCC published a revised Annex H (Stability Operations) to OPLAN COBRA II.⁴⁷ This annex refined and elaborated upon the guidance presented in COBRA II. The plan clearly reflected a growing understanding that the post-hostility security environment would be a challenge, with the greatest risk of violence being in the urban areas of Baghdad, Karbala, An Najaf, Kirkuk, and Mosul. Moreover, the revised annex identified a number of key assumptions that, taken together,

⁴³ Benson interview, August 2004.

⁴⁴ CJTTF-Iraq was to be the organization with the responsibility for securing the peace after major combat operations terminated. It later became CJTTF-7 (discussed below) and consisted of the V Corps headquarters and V Corps units in country at the end of major combat operations.

⁴⁵ Direct support (DS) is defined as “a mission requiring a force to support another specific force and authorizing it to answer directly to the supported force’s request for assistance.” U.S. Department of Defense, Joint Publication 1-02, *Department of Defense Dictionary of Military and Associated Terms*, Washington, D.C.: GPO, April 12, 2001, as amended through June 9, 2004. The DS relationship is commonly used when discussing the relationship of, say, artillery or logistics units to a supported maneuver commander; in such cases a habitual relationship exists. It is not at all clear what is meant by DS when discussing the relationship between two joint task force headquarters.

⁴⁶ For more detail on the planning, operations, and dissolution of Task Force IV, see Bensahel et al., *After Saddam: Prewar Planning and the Occupation of Iraq*, 2008.

⁴⁷ CFLCC, U.S. Army Forces Central Command, Change 2 to “Annex H to CFLCC OPLAN COBRA II, Stability Operations,” February 15, 2003.

established a portrait of the situation that CFLCC envisioned would exist during Phase IV.⁴⁸ It is instructive to note the first assumption: “[p]olicy guidance and endstate will evolve.” This assumption indicates that the commander of CFLCC understood that his plan would need to change; it would need to stay consistent with policy guidance yet to be received; and it would have to accommodate whatever resources (unknown at this point) would be brought to bear by other U.S. government agencies as well as international organizations, nongovernmental organizations, and other coalition members. It also indicates an understanding that the “post-conflict” situation was likely to be very fluid and the plan would have to adapt to future uncertainties.⁴⁹

Once OPLAN COBRA II was completed, the C-5 conducted a series of wargames to test the plan’s assumptions and to identify potential shortcomings that could be rectified before the initiation of hostilities. To facilitate this wargaming effort, Lieutenant Colonel Steven Peterson, the Chief of Intelligence Planning within C-5, directed an aggressive “Red team” effort.⁵⁰ By the middle of February 2003, thanks in part to this effort, the planning staff concluded that, as planned, “the campaign would produce conditions at odds with meeting the strategic objectives” established by CENTCOM.⁵¹ They further concluded that the “joint campaign was specifically designed to break all control mechanisms of the regime and that there would be a period following regime collapse in which [CFLCC forces] would face the greatest danger to [U.S.] strategic objectives.” The assessment went on to describe the “risk of an influx of terrorists to Iraq, the rise of criminal activity, probable actions of former regime members, and the loss of [any weapons of mass destruction] that was believed to exist.”⁵² This assessment did not foresee all challenges that would confront CFLCC during the transition to post-hostility operations, but it did identify a number of actions that needed to be addressed in the plan, including “planning to control the borders, analyzing what key areas and infrastructure should be immediately protected, and allocating adequate resources to quickly reestablish postwar control throughout Iraq.”⁵³

When this assessment was communicated to the commander of CFLCC, he could not be persuaded to adjust the OPLAN, even though such a change would likely have resulted in a much more favorable transition. Although they briefed Lieutenant General McKiernan in February, no one on the planning staff was willing to resurface

⁴⁸ CFLCC, U.S. Army Forces Central Command, pp. H2–H3.

⁴⁹ It is telling that the military commanders with direct responsibility for conducting post-hostility operations felt that their planning was tentative because of the absence of guidance; guidance that should have come from “other U.S. government agencies, as well as international organizations and other coalition members.”

⁵⁰ “Red teaming” is the practice, in the military, of questioning what the enemy might do either in response to friendly actions, or to thwart them from the start. Most plans are Red teamed. Benson interview, August 2004.

⁵¹ Peterson, p. 11.

⁵² Peterson, p. 10.

⁵³ Peterson, p. 10.

the issue later and make the argument that combat forces needed for the warfighting effort should be repositioned in order to better prepare the forces to respond to situations that *might* occur after the war had been won.⁵⁴ In fact, the CFLCC planners had correctly anticipated that coalition forces would not be in position to address the immediate security challenges brought about by the collapse of the Iraqi government. As will be discussed in Chapter Nine, a major repositioning of forces was required during the latter part of April and early May to ensure even a minimum level of security throughout the country.

Even though the planning staff was unwilling to press CFLCC's commander to fundamentally reshape the conduct of major combat operations, their analysis of the post-hostilities environment did convince Lieutenant General McKiernan to create a contingency plan in the event that major combat operations did not play out as anticipated.⁵⁵ With CFLCC's approval, planners at C-5 began writing OPLAN ECLIPSE II as a sequel to the existing OPLAN. The plan had been through 15 revisions by the middle of March 2003, and the final coordinating draft was released on April 12.⁵⁶ As with all other OPLANs, the subordinate and supporting commands all produced their own annexes.

Planting the Seeds of Failure

The coalition achieved a quick and decisive military victory that not only resulted in the destruction and collapse of the Iraqi military, but also caused the disintegration of the command and control capacity of the Iraqi government. Despite the success it produced on the battlefield, however, the planning process failed to include sufficient flexibility to enable CFLCC to respond rapidly to Phase IV security requirements and resources. What accounts for this failure?

- **Resources.** First, there is no evidence that anyone in the military chain of command below CENTCOM expressed a need for additional forces or capabilities for Phase IV operations. This is true despite the reservations expressed by CFLCC planners concerning the size and disposition of forces following major combat operations. Not inconsequentially, both CENTCOM and the Office of the Secretary of Defense consistently underestimated the forces and capabilities required for Phase IV operations.
- **Flawed assumptions.** While it is clear that CFLCC was gaining a realistic appraisal of the potential security challenges that would confront coalition forces

⁵⁴ Peterson, pp. 10–11.

⁵⁵ Commanders routinely build flexibility into their plans to account for changing conditions. Typically, this is done by creating “branches and sequels.” The former are options to the basic plan, and the latter are subsequent operations based on possible outcomes. ECLIPSE II falls into the latter category.

⁵⁶ CFLCC, “OPLAN ECLIPSE II Base Plan,” Coordinating Draft, April 12, 2003.

in the postwar period, the planning staff never challenged some of the basic assumptions outlined in COBRA II. For example, ECLIPSE II assumed that Iraqi civil authorities would “continue to run local and regional essential services.” Moreover, while not listed as a planning assumption, CFLCC envisioned that civil order would be controlled “through published proclamations and the existing legal system where possible.” Although much improved, ECLIPSE II greatly overestimated the degree to which the remnants of the Iraqi government would provide essential services and security in the immediate aftermath of major combat operations. Consequently, military resources were allocated based upon too optimistic a view of both the friendly and enemy situations that would exist during the transition from major combat operations to post-hostility operations.

- **Failed interagency process.** Although collaborative, iterative, and continuous planning took place at all levels of command, there is no record that CENTCOM or CFLCC participated in a similar process with civilian governmental agencies, international organizations, or nongovernmental organizations; military planners, especially at CFLCC, believed such collaboration would be necessary for stability, reconstruction, and transition activities to succeed.

The potential for failure during Phase IV was not unforeseen prior to the initiation of hostilities. General Franks first expressed his concern about the possibility for “catastrophic success” in a meeting with President Bush and the NSC on August 5, 2002. According to Franks, he and Secretary Rumsfeld used this phrase to refer to the possibility that large-scale combat operations could be over much sooner than anyone imagined and, consequently, that functional plans and policies needed to be created in Washington to be prepared for the “occupation and reconstruction.”⁵⁷ In essence, with the exception of immediate security concerns and actions necessary for emergency restoration of critical infrastructure, the majority of activities required for Phase IV were the responsibility of civilian agencies and departments. The Department of Defense, of course, was responsible for providing resources to support these efforts—to the extent they were available and did not conflict with ongoing military operations.

The CFLCC planning staff had come to similar but more ominous conclusions. From their wargaming efforts in January and February 2003, members of the C-5 planning staff had come to believe that not only was there a possibility warfighting would be over much faster than anyone had anticipated, but there was also a great likelihood that the operation would cause a disintegration of the entire Iraqi regime. They further concluded that this governmental collapse was likely to result in some form of civil unrest, lawlessness, or a rise in acts of terrorism. Finally, they concluded that the rapid advance of maneuvering units would place ground forces in positions that might not enable them to adjust rapidly to the immediate postwar situation. A troop-to-task

⁵⁷ Franks, pp. 392, 442.

analysis was conducted to determine how many brigade equivalents would be necessary to maintain security, but the analysis was predicated upon the existence of an effective local police force. No one anticipated, and therefore no one planned for, the requirements for maintaining security in the absence of local police.

The immediate consequences of the U.S. government's failure to adequately insist on a credible interagency planning and execution process for post-hostility operations, and the failure to resource the military requirements identified (albeit late) by the CFLCC planners, resulted, as predicted, in a situation in which forces on the ground were inadequate to provide adequate security. The 3rd Infantry Division summed it up succinctly in its after action report:

The President announced that our national goal was "Regime Change." Yet there was no timely plan prepared for the obvious consequences of a regime change. Although efforts [were made] to identify and hire personnel to operate ORHA, even as late as 15 April, ORHA had at best a working draft plan of post Saddam Iraq. Additionally, the delay in having the civilian authority on the ground (while perhaps justified by security concerns) made commanders reluctant to move too quickly regarding phase IV [stability and support operations] activities, as they were concerned that their actions might be inconsistent with ORHA efforts—which either didn't exist or had not been shared with the military. Bottom line: despite the virtual certainty that the military would accomplish the regime change, there was no plan for oversight and reconstruction, even after the division arrived in Baghdad.⁵⁸

The report raised the lack of planning and resourcing as major issues and offered this recommendation:

State, Defense, and other relevant agencies must do a better and timelier job planning occupation governance and standing up a new Iraqi government. If this is not possible, the best alternative would have been to let the military plan and execute the mission for a month or more, then turn it over to the civilian overseer. This would have avoided the power/authority vacuum created by our failure to immediately replace key government institutions.⁵⁹

⁵⁸ *Operation Iraqi Freedom: Third Infantry Division (Mechanized) "Rock of the Marne" After Action Report, Final Draft, May 12, 2003, p. 31-12.*

⁵⁹ *Operation Iraqi Freedom: Third Infantry Division (Mechanized) "Rock of the Marne" After Action Report, p. 31-12.*

Implications for Planning Policy

If the possibility of “catastrophic success” was shared by both CENTCOM and CFLCC, why weren’t they prepared for the postwar looting and violence that took place in Baghdad and other urban areas in Iraq in the immediate aftermath of major combat operations? While critics have argued that this was the result of a lack of planning, it is clear that detailed post-hostility planning was conducted at both CENTCOM and CFLCC. Both the CENTCOM and CFLCC plans established endstate conditions and directed specific actions to ensure a successful transition to post-combat operations. In fact, having been designated the supported command within CENTCOM for post-hostility operations, CFLCC developed OPLAN ECLIPSE II specifically to address Phase IV operations as a sequel to major combat operations. Thus, it was not a lack of planning that led to the coalition’s military forces being unprepared for the immediate postwar challenges. Instead, problems arose from the *ineffectiveness* of the planning process in identifying the resource requirements likely to be needed in the transition to post-hostility operations, and the failure to challenge set assumptions about what postwar Iraq would look like. Thus, the real question becomes: Why was the planning process that resulted in the quick and decisive defeat of the Iraqi military so ineffective in preparing for postwar operations?

The full answer to this question requires an analysis of civilian policy and planning within and among the numerous U.S. governmental agencies and departments with responsibilities relating to reconstruction. As Franks pointed out at NSC meetings, decisions and plans had to be made in advance of the war to enable the full weight of U.S. government capabilities to be brought to bear quickly on stability and reconstruction tasks in Iraq. This was echoed, after major combat operations in May, by the 3rd Infantry Division in its after action report as discussed earlier. Prewar interagency planning and collaboration fell far short of what was necessary.

The failures of the interagency process, however, do not explain why the military was so ill prepared to respond to the security concerns that arose in the immediate aftermath of major combat operations. While there are many reasons for this failure, the overarching cause is the bias toward warfighting in general, and major combat operations in particular, that permeated the education, training, and doctrine systems within the U.S. military at the time. For example, from the moment officers entered the U.S. military prior to 9/11, they were taught skills necessary to fight and win contests with enemy combatants on the battlefield. The overwhelming majority of training time during the Cold War was dedicated to individual education and small unit training as it relates to defeating enemy forces in the field.

As depicted in Figure 3.3, the number of troops on the ground in Iraq, and in Baghdad, at the beginning of Phase IV was far less than required in either Bosnia

Figure 3.3
Military Presence at Outset of Post-Conflict Operations

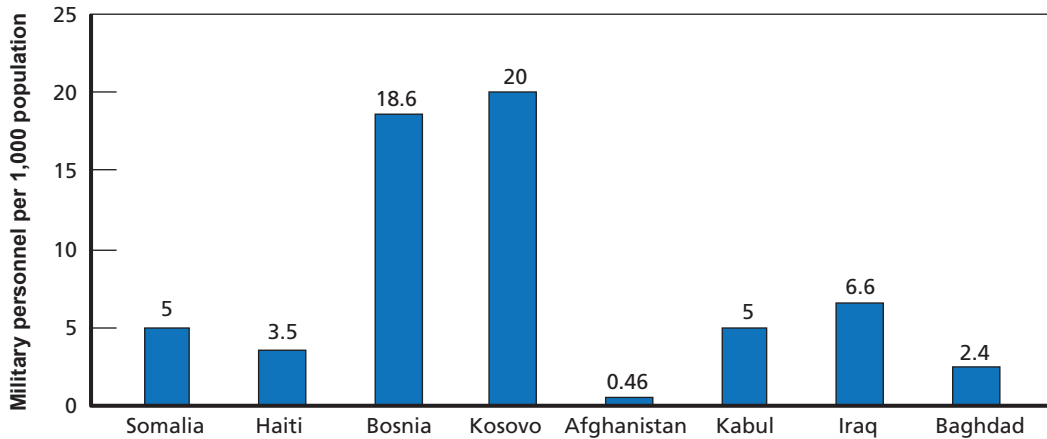

SOURCE: James Dobbins et al., *America's Role in Nation-Building: From Germany to Iraq*, Santa Monica, CA: RAND Corporation, MR-1753-RC, 2003.

RAND MG641-3.3

or Kosovo.⁶⁰ According to a RAND report published in 2003, if the levels of troops committed in Kosovo were used as a guide, 526,000 troops would have been needed to address immediate postwar security concerns in Iraq.⁶¹ Drawing from his personal experience in the Balkans and a number of studies produced by and for the Army prior to the initiation of war with Iraq, then Chief of Staff of the Army General Eric Shinseki concluded that it would require approximately 400,000 soldiers to maintain security in the immediate aftermath of major combat operations.⁶²

Anecdotal evidence suggests that other Army general officers shared General Shinseki's main concern, namely, that more troops would be needed immediately following combat with Iraqi forces than would be required to defeat those same forces;

⁶⁰ The numbers used for Somalia, Haiti, Bosnia, and Kosovo are taken from another RAND study. Deviating from that study here, we have combined the total number of peacekeepers in Kabul with the 8,000 members of the U.S. military operating elsewhere in Afghanistan where they are conducting combat operations to arrive at the ratio of 0.46 (rather than the 0.18 one derives if one only counts the international peacekeeping forces). The ratio for Kabul is computed using the 5,000-man international peacekeeping force compared with an estimated population of 1,000,000. The ratio for Baghdad is based on a population figure of 6.2 million, and it assumes that six brigade equivalents could muster no more than 15,000 soldiers for active security purposes.

⁶¹ Dobbins, p. 197.

⁶² Transcript of interview with James Fallows, conducted January 28, 2004, for an episode of the PBS program *Frontline* entitled "The Invasion of Iraq," first aired February 26, 2004. As of August 2007: <http://www.pbs.org/wgbh/pages/frontline/shows/invasion/interviews/fallows.html>

however, none spoke up publicly before the war.⁶³ What is clear is that the military was unprepared for the immediate aftermath of the war. Perhaps the commander of the U.S. Army's V Corps, Lieutenant General William Wallace, summed it up best when he stated:

The military did their job in three weeks. I give no credit to the politicians for detailed Phase Four planning. But I don't think that we, the military, did a very good job of anticipating [that] either. I don't think that any of us either could have or did anticipate the total collapse of this regime and the psychological impact it had on the entire nation. When we arrived in Baghdad, everybody had gone home. The regime officials were gone; the folks that provided security of the ministry buildings had gone; the folks that operated the water treatment plants and the electricity grid and the water purification plants were gone. There were no bus drivers, no taxi drivers; everybody just went home. I for one did not anticipate our presence being such a traumatic influence on the entire population. We expected there to be some degree of infrastructure left in the city, in terms of intellectual infrastructure, in terms of running the city infrastructure, in terms of running the government infrastructure. But what in fact happened, which was unanticipated at least in [my mind], is that when [we] decapitated the regime, everything below it fell apart.⁶⁴

The sentiment expressed by both General Shinseki and Lieutenant General Wallace was echoed by L. Paul Bremer, the administrator of the Coalition Provisional Authority (CPA). On October 4, 2004, Bremer stated that the United States made two major mistakes in Iraq: not deploying a sufficient number of troops and not adequately controlling the looting and lawlessness that ensued in the immediate aftermath of major combat operations. Bremer continued by saying, "We paid a big price for not stopping [the looting] because it established an atmosphere of lawlessness."⁶⁵ In an earlier speech delivered on September 17, 2004, Bremer is reported as having said: "The single most important change—the one thing that would have improved the situation—would have been having more troops in Iraq at the beginning and throughout" the entire occupation of Iraq.⁶⁶

The U.S. military experience in Iraq points to a shortcoming in U.S. military doctrine, which is predicated on existing military theory. Defeating enemy military

⁶³ For more information on this point, see Chapter Four.

⁶⁴ Transcript of interview with Lieutenant General William Scott Wallace for an episode of the PBS program *Frontline* entitled "The Invasion of Iraq," first aired February 26, 2004. As of August 2007: <http://www.pbs.org/wgbh/pages/frontline/shows/invasion/interviews/wallace.html>

⁶⁵ Robin Wright and Thomas E. Ricks, "Bremer Criticizes Troop Levels: Ex-Overseer of Iraq Says U.S. Effort Was Hampered Early On," *Washington Post*, October 5, 2004.

⁶⁶ Wright and Ricks.

forces must always remain a focus of military doctrine, but more emphasis needs to be placed on what it takes to “win the war”—from a broader context than simply defeating the enemy’s military. The success of the ground campaign in OIF demonstrates the importance of theory and doctrine as an effective guide to how battles should be prosecuted. However, the warfighting bias extant in theory and doctrine at the time left the military ill prepared to complete the overarching task of winning the peace—the ultimate object of war.

Summing Up the Planning Process for Iraq

In contrast to the mere 25 days available to plan for Operation ENDURING FREEDOM in Afghanistan, planning for Operation IRAQI FREEDOM took place over 15 months. In addition, planning benefited from the United States’s 12-year involvement with Iraq, including several years of NORTHERN and SOUTHERN WATCH. Nevertheless, despite these advantages, the OIF plan that was eventually executed on March 19, 2003, only vaguely resembled the plan CENTCOM had developed and all its intermediate variants. The 19th-century chief of the Prussian General Staff, Helmuth von Moltke, once observed that “no plan of operation extends with any certainty beyond the first contact with the main hostile force.” However, General Dwight D. Eisenhower observed that “while [this may be true], I still cannot fail to plan.” The planning process is a useful learning experience—a kind of “warmup” exercise—for the commander and his staff. OPLAN 1003V was no exception.

The planning process for OIF included considerable guidance from the President and Secretary of Defense—perhaps an unprecedented amount as warplans go. The President was briefed twelve times from December 28, 2001, to February 7, 2003. In addition, Secretary Rumsfeld met with General Franks frequently, and they talked by telephone early most mornings.⁶⁷ In response to guidance from General Franks and his senior staff, the small, secret planning staff at CENTCOM headquarters revised the plan frequently, beginning in December 2001 through execution of the plan in March 2003.

In this case, the concerns of the President and the Secretary of Defense were not so much about the details of combat operations (although, as evidenced by the preceding narrative, operational details were often discussed). Instead, they worried about the size of the force, the time required to deploy it, its ability to quickly prevail, and the negative effects of inflicting noncombatant casualties. OIF was to be a war of liberation and not conquest. Hence, U.S. forces should not appear to be planning an invasion

⁶⁷ General Franks remarked to the author in an interview in August 2002 that he spoke to Secretary Rumsfeld every morning around 7:00 A.M.—to the consternation of his staff who were required to prepare talking points for him at an even earlier hour.

of Iraq to seize control of the country indefinitely. Like Afghanistan, it was important that the administration in Iraq have an Iraqi face as soon as possible.

Getting the Force Size Right

The operational planning story is really the story of planning to defeat Saddam. Most of the planning consisted of preparing for decisive operations, Phases II and III. The iterative planning process described in this chapter documents the amount of effort devoted to ensuring that the right forces were in the right place prior to the start of hostilities. The primary objective was the defeat of Saddam and the toppling of his regime. Although dealing with the aftermath was discussed, far fewer resources were devoted to planning for post-hostilities conditions.

Most notable was the absence of any serious discussion of the size of the force required to secure the post-major combat phase. Rosy assumptions about how coalition forces would be greeted, the viability of Iraqi institutions, and the postwar role of an institutional Iraqi army led planners to underestimate the number of coalition troops that would be needed. In fact, discussions centered on reducing the force size as combat operations ceased. Just how large a miscalculation this was is evidenced by the state of play in Iraq following the end of major combat operations in May 2003.

Inverted Planning

Recent conflicts resemble the Iraq experience more than the conventional conflicts of the first half of the 20th century. And in the future, we are likely to face conflicts that, like this one, require U.S. and allied forces to quickly defeat an outmatched opponent and then spend months or years winning the peace. This argues for an inverted planning process. That is, the military and civilian force required to reconstruct, govern, and secure the peace should be the primary focus of the plan, which means that the military may have to cede the lead in planning to an interagency process.

In planning for OIF, CENTCOM knew that the forces it would confront were weak and could be easily defeated. Although there was legitimate concern over Saddam's use of WMD against the coalition, defeating the enemy was never an issue. Nevertheless, CENTCOM spent 18 months conducting detailed planning for the major combat phase of the conflict and much less time planning for the aftermath of victory.

Land Operations

Bruce R. Pirnie, John Gordon IV, Richard R. Brennan, Jr., Forrest E. Morgan, Alexander C. Hou, Chad Yost, Andrea Mejia, David E. Mosher

The account presented here depicts Operation IRAQI FREEDOM as a discrete campaign. As Chapter Two has shown, however, it was actually part of a protracted confrontation between the United States and Iraq that began in 1990. Before 1990, the United States had tried to maintain friendly relations with Saddam Hussein. Indeed, the United States had favored Iraq during its war against Iran, although Iraq was the aggressor. From a geopolitical point of view, Iraq appeared to be a bulwark against Iran, whose extreme Islamic regime promoted holy war against the United States and Israel. But on August 2, 1990, Saddam Hussein invaded Kuwait to annex that country and exploit its large oil reserves. This time, the United States sided with the victim and led a coalition mandated by the UN to evict Iraqi forces. The United States prepared for a difficult war and was surprised when most Iraqi forces offered little opposition. It terminated the war after only four days of ground fighting, allowing most of the Republican Guards to escape destruction.

After the first Gulf War, Saddam Hussein brutally repressed a Shi'ite revolt in southern Iraq. He defied the UN when it attempted to ensure that he had stopped trying to develop weapons of mass destruction. When the second Bush administration took office, Saddam Hussein was still refusing to cooperate with UN inspectors, and the United States found it increasingly difficult to muster support for economic sanctions. During 2002 and into early 2003, the administration oversaw a planning effort for a campaign against Iraq that would change the regime. Iraq might have seemed formidable in 1990, but a decade later it presented a different picture. It had lost large amounts of military equipment that could not be replaced due to sanctions imposed by the UN. It no longer exerted control over the Kurdish-inhabited north, where two Iraqi corps were devoted to defensive operations. Both its air force and its navy had effectively ceased to exist. Not surprisingly, U.S. military planners were willing to initiate operations in 2003 with far fewer forces than had seemed necessary in 1991.

This chapter describes how the war began, the phases of large-scale conventional combat, special operations, and the effort directed against weapons of mass destruction.

Overview

The CENTCOM commander, General Tommy Franks, explained his concept for the campaign to Secretary of State Powell at a meeting on September 6, 2002:

At the Saturday morning discussion, Colin Powell did raise his concerns. . . [H]e questioned the friendly-to-enemy force ratios, and made the point rather forcefully that the Coalition would have “extremely long” supply lines. “These are issues we should consider,” he said.

Thanking him for his thoughts, I used a detailed map to introduce the concept of five simultaneous operational fronts. “We are moving into a new strategic and operation paradigm here, Mr. Secretary,” I said.

“By applying mass simultaneously at key points, rather than trying to push a broad, slow conventional advance, we throw the enemy off balance. We saw this in Afghanistan—rapid, fast maneuver. This creates momentum. We put our forces deep into the enemy’s territory, moving so quickly that the Iraqis will not have time to react. When they finally do move, they become targets for the air component. Speed and momentum are the keys.”¹

Figure 4.1 gives an overview of OIF.

What follows is a general account of the war intermixed with detailed descriptions of certain segments of the operation. These are reported in greater detail because they illustrate a particular aspect of the war, were critical to the outcome, or received considerable public attention.

The War Begins

Dora Farm was a compound enclosing buildings and grounds used by Saddam Hussein’s family. It was located on the Tigris River in a suburb of Baghdad. According to an account by Bob Woodward, an agent of the Central Intelligence Agency (CIA) had recruited an informant who was responsible for security at Dora Farm. On March 18, 2003, this informant reported that there was activity at Dora Farm indicating that a high-level visit was imminent, possibly by Saddam Hussein. Sometime after 12:30 P.M. Washington time (8:30 P.M. local time), the CIA received a report that the informant had seen Saddam Hussein at Dora Farm. Saddam had left there to attend meetings, according to the report, but would return with his sons Qusay and Uday to stay overnight.

That afternoon, the Director of Central Intelligence, George Tenet, met with President Bush and Secretary of Defense Rumsfeld in the Oval Office. Tenet described

¹ Franks, pp. 395–396.

Figure 4.1
Overview of Operation IRAQI FREEDOM, March 19 to April 14, 2003



RAND MG641-4.1

the CIA informant and another informant, who had arrived at Dora Farm to set up communications. Bush asked what weapons would be used, if he were to authorize a strike on Dora Farm. The Chairman of the Joint Chiefs of Staff, General (USAF) Richard B. Myers, proposed using 15–17 Tomahawk cruise missiles. Bush also asked who occupied the various buildings and whether the compound might not simply house Saddam's family. The CIA subsequently received a report that Saddam was expected back early in the morning local time. The informants provided additional details on the compound, including the existence of a concrete shelter or bunker located underground and apart from the main residence. Early in the evening, Bush met with Tenet, Vice President Richard Cheney, Rumsfeld, Secretary of State Powell, and Myers in the Oval Office. Satellite imagery indicated that a building had once stood between the main residence and Saddam's wife's house. Analysts decided that the open field where this building had stood must be the location of the underground bunker. Tenet said that "It's as good as it gets. I can't give you 100 percent assurance, but this is as good as it gets."²

² Woodward, p. 387.

Myers pointed out that Tomahawks could not penetrate a bunker; the attack would have to include Enhanced Guided Bomb Unit-27 delivered by F-117 aircraft.³ Myers conferred with Franks, who initially said that no F-117s were ready but subsequently discovered that his air component had quietly prepared an F-117 to fly the mission from Al Udeid Air Base in Qatar. In the Oval Office, the President's senior advisors debated the implications of a strike on Dora Farm. Powell and the White House's communications director Karen Hughes argued strongly that a strike would imply initiation of hostilities, which the President should announce publicly, and Bush agreed. He then conferred with Cheney alone, who said that if a decapitation strike were successful, it might save lives and shorten the war. Cheney recommended carrying out the strike. Subsequently, Bush authorized it and the strike took place.

Shortly before dawn in Washington, the CIA relayed a report on the Dora Farm strike from one of its agents. According to this report, the CIA informant had been killed by a Tomahawk; one of Saddam Hussein's sons shot one of the CIA's sources in the knee; and Saddam Hussein himself had been dug out of the rubble, placed on a stretcher, and taken away by ambulance. Tenet called the duty officer at the White House Situation Room and reported that Saddam Hussein had been hit in the strike.

Overview

The Tigris-Euphrates Valley was the region of decisive operations to defeat Iraqi forces and to overthrow Saddam Hussein. In this region, Army and Marine Corps forces conducted a series of meeting engagements, often associated with key terrain, such as river crossings, road interchanges, and centers of government power. Iraqi forces were a mixture of Special Republican Guards, Republican Guards, Ba'athist militia, and Fedayeen Saddam that appeared to lack central direction. They delivered intense but poorly aimed fire and conducted headlong assaults, often senselessly repeated despite huge losses. Most Iraqi forces, particularly the regular army, chose not to fight, but those that did fight often displayed reckless courage.

U.S. strategy was to advance quickly to Baghdad, bypassing all other cities as much as possible. CENTCOM planners recognized that occupying urban areas could absorb more forces than they had available. Indeed, CENTCOM ultimately committed most of its operational reserve (101st Airborne Division, elements of the 82nd Airborne Division, and Task Force Tarawa) to urban operations intended to secure long, vulnerable lines of communication. The British contingent built around the 1 UK Armoured Division focused on southern Iraq while the U.S. force advanced northward. When urban combat occurred, it strongly resembled combat elsewhere during the advance: violent but usually brief meeting engagements. During the invasion, the

³ EGBU-27 is a penetrating bomb in the 2,000-pound class. It supplements the laser guidance of GBU-27 with inertial navigation and the Global Positioning System to improve accuracy. It is an all-weather weapon that requires no further input after launch, allowing the pilot to depart immediately after releasing the weapon.

Iraqi regime used the tactics of guerrilla warfare without having the popular support essential for guerrilla warfare to succeed.

Lines of Communication

The lines of communication in the Tigris-Euphrates Valley were largely restricted to highways and major roads. In much of the terrain between the Tigris and Euphrates Rivers, offroad mobility was severely restricted by canals, drainage ditches, and poorly drained land. Indeed, in some instances, tanks sank nearly to their turrets and took hours to extract. Fortunately for the coalition, Iraq had a network of modern highways connecting major cities. These highways were often multilane and crossed by overpasses in urban areas. (See Figure 4.2.)

At the time of the invasion, Highway 1 was unfinished, but with some additional work, it was trafficable along its entire length. Some stretches were paved, while others were merely graded. The bridge over the Euphrates west of An Nasiriyah was in place, but its approaches were still incomplete. During the campaign, bridges were often hotly contested as key terrain, especially the bridges over the Euphrates in the vicinity of An Nasiriyah, a Euphrates bridge east of Karbala (Objective PEACH), and bridges over the Diyala River east of Baghdad.

Outflanking Iraqi Forces

The Iraqi I, II, and V Corps were deployed to defend Iraq against the Kurdish peshmerga and whatever U.S. forces might attack from Turkey. The Iraqi III and IV Corps were deployed in Al Basrah province and along the Iranian frontier—with the exception of the 11th Infantry Division, which was deployed in the An Nasiriyah area. The Republican Guard divisions were deployed around Baghdad, except for the Ad Adnam and Nebuchadnezzar Divisions, which were deployed in the north.

During the course of the campaign, most Iraqi forces were operationally immobile, although they did make some tactical moves. They all stayed in their original locations, except for two Republican Guard divisions deployed in the north. The Ad Adnam Division descended into the upper Euphrates Valley, and elements of the Nebuchadnezzar Division traveled to the Baghdad area to help defend the capital. As a result, there were no regular Iraqi ground forces to contest an advance west of the Euphrates River, excepting the 11th Infantry Division in An Nasiriyah. (See Figure 4.3.)

Combat Phases

Combat operations in the Tigris-Euphrates region fell into three fairly distinct phases. The first featured rapid advances deep into Iraq, roughly to An Najaf and just south of Ad Diwanayah, bypassing urban areas. It lasted seven days, from March 19 through March 25. The second phase was characterized by consolidation and buildup for the

Figure 4.2
Iraqi Road Net

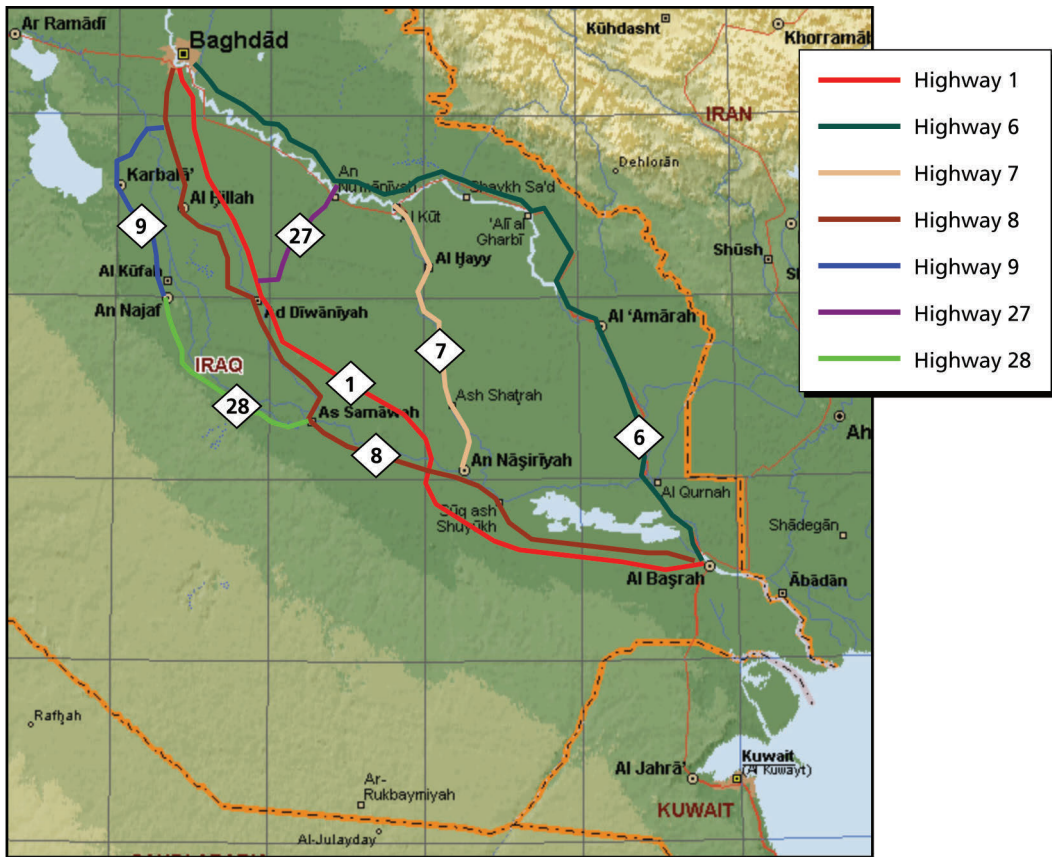

SOURCE: 3rd Infantry Division (Mechanized), *Operation Iraqi Freedom, After Action Report*, Fort Stewart, Georgia, 2003; 1st Marine Division, *After Action Report, 1st Marine Division, Operation Iraqi Freedom*, Camp Pendleton, California, 2003.

NOTE: Highway 1 was under construction.

RAND MG641-4.2

push to Baghdad. It lasted six days, from March 26 through March 31. The third phase saw decisive combat operations resulting in the occupation of As Samawah, An Najaf, Baghdad, and Tikrit. It lasted fourteen days, from April 1 to April 14.⁴

The United States had planned to deploy large U.S. forces in and through Turkey, but at the last minute the Turkish parliament declined to allow access. Starting in July 2002 with a visit to Ankara by Deputy Secretary of Defense Paul Wolfowitz, the United States negotiated with Turkey concerning terms and conditions for access in

⁴ The phases referred to here are not to be confused with the planning phases discussed in Chapter Three. The combat phases described in this chapter are essentially subphases of planning Phases II and III.

Figure 4.3
Flanking Iraqi Forces During Operation IRAQI FREEDOM

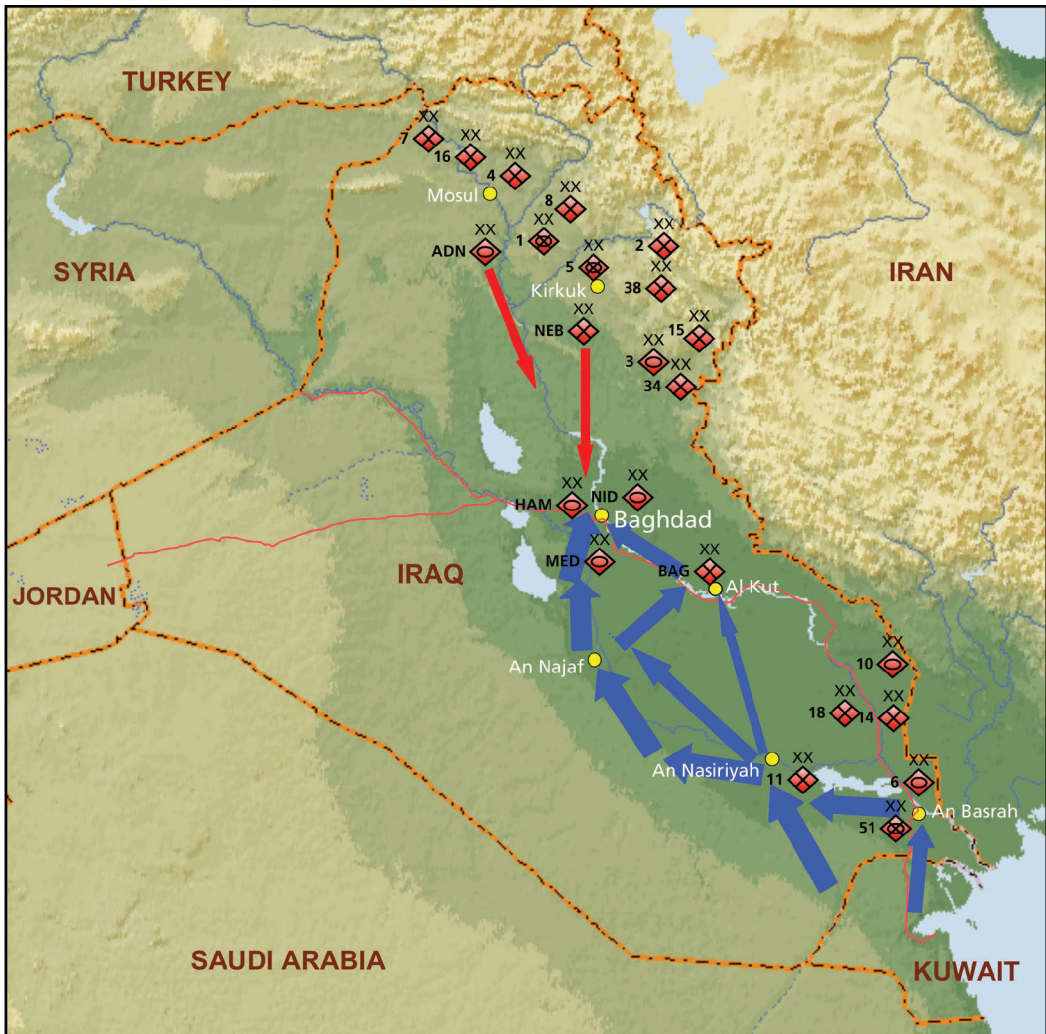

SOURCE: 3rd Infantry Division (Mechanized), *Operation Iraqi Freedom, After Action Report*, Fort Stewart, Georgia, 2003; 1st Marine Division, *After Action Report, 1st Marine Division, Operation Iraqi Freedom*, Camp Pendleton, California, 2003.

RAND MG641-4.3

the event of a U.S. invasion of Iraq. In November 2002, the recently formed Justice and Development Party won national elections in Turkey. This party was a moderate successor to the Welfare Party, which had been dissolved by decree in 2000 for being too fervently Islamic. Its leader Recep Tayyip Erdogan was still banned from parliament when the United States hosted him in the White House as though he were already head of state. During February 2003, the United States and Turkey negoti-

ated intensely concerning conditions for basing and transit. The United States offered \$6 billion in grants and \$20 billion in guaranteed loans, while Turkey reportedly asked for much larger sums.⁵

On February 25, 2003, the Turkish armed forces presented a draft agreement to parliament for ratification. Under its terms, Turkey would have granted access to 62,000 U.S. troops, including the 4th Infantry Division (Mechanized), the 3rd Armored Cavalry Regiment, unspecified special operations forces, and 225 fixed-wing aircraft. On March 1, the parliament voted 264–250 in favor with 19 abstentions, just a few votes short of the required absolute majority. Although the vote was taken in secret session, it would appear that some members of the Justice and Development Party must have joined the opposition Republican People's Party to decline the agreement.

At the time of the parliamentary vote, equipment for the 4th Infantry Division and supporting units was aboard some 35 ships at sea in the Eastern Mediterranean. These ships remained off Turkey for several weeks following the vote, apparently in the hope that Turkey would reverse its decision. On March 25, President Bush told General Franks that the United States could not persuade Turkey to allow transit. Franks responded by asking permission to keep the 4th Infantry Division's equipment in the Eastern Mediterranean for another day to help fix Iraqi forces in the north.⁶ Thereafter, these ships sailed through the Suez Canal and the Persian Gulf to offload in Kuwait. The 4th Infantry Division road marched through central Iraq to the Tikrit area, where it relieved elements of the 1st Marine Division for occupation duty.

Had Turkey granted transit rights as expected, the 4th Infantry Division and other U.S. forces would have invaded Iraq from the north, perhaps hastening the fall of the Ba'athist regime. In addition, U.S. fighter aircraft would have operated more efficiently over the northern part of Iraq. Better access to Turkish territory would thus have facilitated the invasion of Iraq, but would not have altered the outcome. There is little evidence to suggest that earlier arrival of the 4th Infantry Division would have made much difference to the occupation of Iraq. Even with these additional forces, the United States would still have had too little infantry strength to stop widespread looting, unless it had been willing to shoot looters.

Combat Phase 1: Rapid Advance (March 19–25)

The first combat phase of the ground offensive operations began on March 19, 2003, when the 3rd Infantry Division (Mechanized), Task Force Tarawa (the 2nd Marine Expeditionary Brigade containing about 7,200 sailors and marines), and the 1st Marine

⁵ For an account, see Barak A. Salmoni, "Strategic Partners or Estranged Allies: Turkey, the United States, and Operation Iraqi Freedom," *Strategic Insights*, Vol. II, Issue 7, July 2004.

⁶ Franks, p. 500.

Division passed through the berm along the Iraq-Kuwait border and advanced into Iraq. The 1st Marine Division quickly overran Iraqi forces in the Al Basrah area and then swung west, leaving several Iraqi forces, including the 10th Armored Division, on its right flank. The Army's 3rd Infantry Division (Mechanized) went directly to the An Nasiriyah area and then advanced north on the west bank of the Euphrates River. Both divisions encountered strong localized resistance from Fedayeen Saddam plus some mixture of Al Quds militia and Ba'athists generally. In addition, they encountered some foreign fighters, generally from Syria. While the U.S. force advanced northward, the British 1st Armoured Division entered Basrah, Iraq's second-largest city.

U.S. forces operated under the assumption that Iraq had weapons of mass destruction and might use them during the invasion, especially when Baghdad was threatened. They took several steps to counter this threat. They air-dropped leaflets warning that any Iraqi unit that used WMD would face severe retribution. Patriot batteries accompanied Army and Marine Corps forces to defend against ballistic and cruise missiles, which might have chemical or biological warheads. Patriot also defended friendly countries in the region. Teams equipped with the M-93A1 reconnaissance vehicle deployed to detect and alert for WMD use. Troops were equipped with protective masks, protective clothing, and antidotes to nerve gas. However, they donned masks only when alerted to possible WMD use.

March 23 was the most difficult day during the initial phase. On that day, Task Force Tarawa entered An Nasiriyah just after the survivors of the Army's 507th Maintenance Company (in which PFC Jessica Lynch served) escaped from the city. The marines took the two bridges on the eastern side of the city but at considerable cost. One marine rifle company from Task Force Tarawa suffered 18 dead and 36 wounded during the battle. That night the Army's 11th Attack Helicopter Regiment conducted an ill-fated attack on the Republican Guard Medina Division near Karbala. One Apache helicopter was shot down and all the returning aircraft suffered various degrees of damage.⁷

On March 25, the period of rapid advance concluded with U.S. forces in the locations shown in Figure 4.4. Iraqi forces held key cities, including An Nasiriyah, As Samawah, An Najaf, and Ad Diwaniyah with mixtures of forces in which Fedayeen and Ba'athist militia played leading roles. The 3rd Infantry Division lacked enough troops to occupy these cities and therefore avoided them. The Iraqi III Corps remained in static positions on the southeastern border with Iran. In front of the 3rd Infantry Division stood the Iraqi Medina Division deployed in the Karbala Gap. Ahead of the 1st Marine Division lay the Baghdad Division deployed in and around the city of Al Kut.

While U.S. Army and Marine Corps forces advanced northward, the British consolidated their position around Basrah. Over March 23–25, the 1 UK Armoured Divi-

⁷ Remarkably, Apache helicopters riddled with small arms fire and RPGs managed to return with crews intact, a testimony to the combat worthiness of these aircraft.

Figure 4.4
Rapid Advance to An Najaf

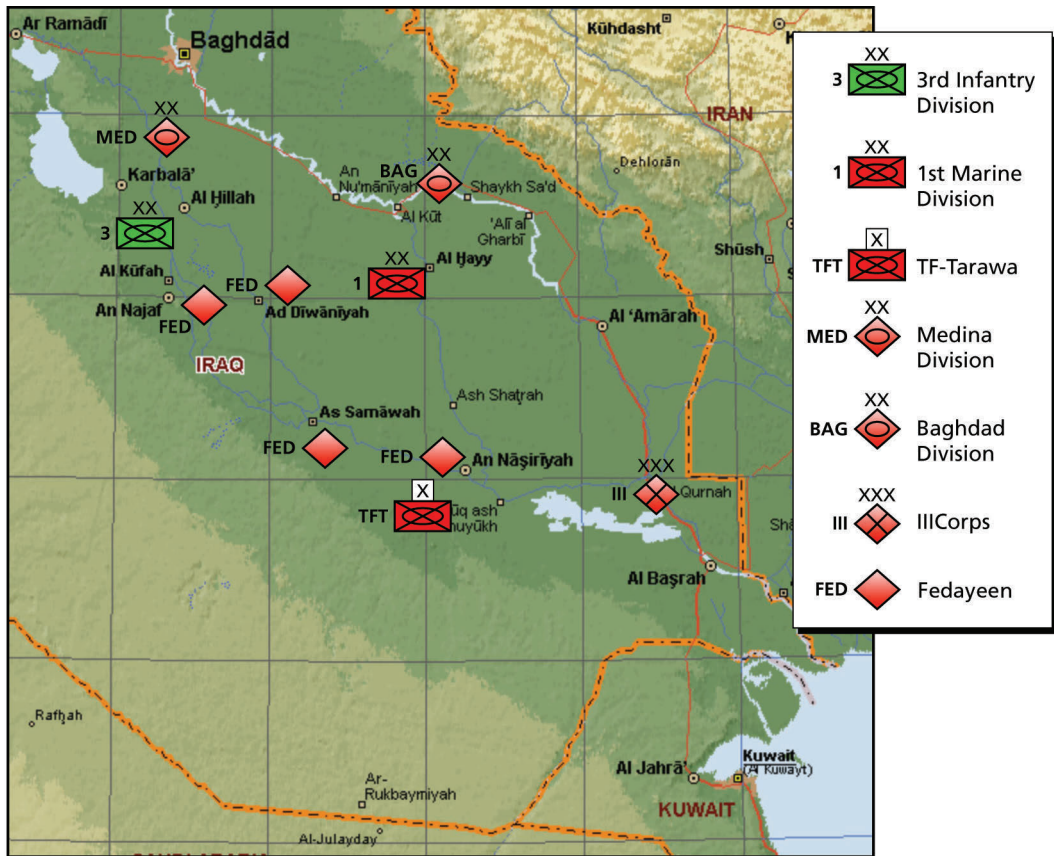

SOURCE: 3rd Infantry Division (Mechanized), *Operation Iraqi Freedom, After Action Report*, Fort Stewart, Georgia, 2003; 1st Marine Division, *After Action Report, 1st Marine Division, Operation Iraqi Freedom*, Camp Pendleton, California, 2003.

RAND MG641-4.4

sion secured the key Rumayyah oil fields near Basrah, simultaneously consolidated control of Umm Qasr, and moved closer to Basrah. By March 25 the British had isolated Basrah and were monitoring the civilian situation inside the city, making preparations to exploit it quickly should it appear that Iraqi government and military control was about to collapse.⁸

During this initial period, U.S. forces met little resistance from Iraqi regular forces. Few enemy forces were located in southern Iraq where they could have resisted the advance, and those few—for example, the forces defending in the South Rumayyah complex—quickly disintegrated. The stiffest resistance came from Fedayeen, who were

⁸ CFLCC, “History of the Ground War,” briefing, July 2003.

utterly determined but tactically inept. The U.S. forces were overwhelmingly superior in combat power, yet their position in Iraq had some precarious aspects. They were at the end of long lines of communication that were very lightly defended or not defended at all. At any time, Iraqi forces might venture out from cities along the route and try to attack U.S. convoys. On March 25, the 3-7th Cavalry of the 3rd Infantry Division (Mechanized) was reported to have lost two M-1A1 tanks and an M-3 cavalry vehicle to AT-14 Kornet anti-tank guided missiles. This report later proved to be false.⁹

Lieutenant General William Wallace, commanding V Corps, decided that he needed time to prepare for an offensive through the Karbala Gap to Baghdad. Once U.S. forces began this offensive, there would be no opportunity to pause. They would be within Saddam Hussein's "Red Zone," where he might mass his remaining forces and use WMD in a last attempt to save his regime. Moreover, V Corps needed time to assemble an accurate intelligence picture of the enemy. Battle damage assessment lagged events on the battlefield by 48 hours, and Wallace had no idea how strong the Medina Division still was following various air attacks. For these reasons, Army and Marine Corps units paused and prepared for the final attack toward Baghdad.

An Nasiriyah (March). Task Force Tarawa was directed to seize the bridges east of An Nasiriyah—to allow passage of the 1st Regimental Combat Team (RCT-1) north on Highway 7 toward Al Kut.¹⁰ Task Force Tarawa accomplished this mission successfully but became tied down by Iraqi resistance in An Nasiriyah, depriving the 1st Marine Expeditionary Force of its operational reserve.

The 2nd Marine Expeditionary Brigade began its journey to Iraq on January 3, when it embarked on amphibious ships in the United States. From January 15 to 18, the brigade disembarked at Kuwait Naval Base. Upon arrival in Kuwait, the brigade was renamed Task Force Tarawa. While in Kuwait, Task Force Tarawa zeroed and calibrated its weapons at the Udari Range Complex and conducted maneuver training. On March 19, it received orders to move to Assembly Area Hawkins near the Iraq-Kuwait border. Task Force Tarawa was positioned within V Corps' battlespace with the 3rd Infantry Division to its left and the 1st Marine Division to its right.

Task Force Tarawa's mission was to support 1st Marine Division in its advance toward Baghdad. Its initial task was to secure Jalibah Airfield, the planned location of logistics support area Viper, which was eventually secured by 3rd Infantry Division. Then it would relieve 3rd Infantry Division at the crossing site of Highway 1 over the Euphrates River west of An Nasiriyah. In addition, the task force prepared to secure crossing sites east of Nasiriyah and attack north toward Qalat Sikar. It might then expect to conduct further combat operations to the north.

⁹ CFLCC.

¹⁰ Task Force Tarawa was built around the 2nd Marine Expeditionary Brigade and was slated to become the operational reserve for the 1st Marine Expeditionary Unit.

On March 21, Task Force Tarawa created four lanes through the berms, ditches, and wire obstacles on the Iraq-Kuwait border. On the evening of March 22, Tarawa relieved elements of 3rd Infantry Division at the Tallil Air Base south of An Nasiriyah, freeing these forces to continue advancing north. At the same time, 1st Marine Expeditionary Force (I MEF) directed Tarawa to launch an attack on the western crossing sites not later than 9:00 A.M. the following day.

An Nasiriyah (Figure 4.5) with its suburbs encompassed a population of about 535,000 people, largely Shi'ites hostile to the regime of Saddam Hussein. The city lay between the Euphrates River to the south and the Saddam Canal to the north. Terrain around the city was open and sandy, dissected by numerous canals and irrigation ditches. Most buildings in the sprawling city were masonry or mud brick and either one or two stories high. The major Iraqi unit defending Nasiriyah was the 11th Infantry Division of the regular army. According to intelligence estimates, this division was likely to capitulate and could not mount a coherent defense. The Iraqi army's most likely course of action would be to defend briefly, then retreat north on Highway 7. The strength and composition of paramilitary forces was unknown.

The 507th Maintenance Company. Early on the morning of March 23, the Combined Anti-Armor Team and a company of tanks led the advance toward An Nasiriyah. At a railway bridge south of the city, these forces encountered enemy machine gun and mortar fire. They called for artillery fire and support from AH-1W Cobras to suppress the enemy fire. At the same time, they fired directly with TOW missiles and the main guns of the tanks. During this combat, the marines saw Army vehicles approaching their position from the north, from Nasiriyah. They met an Army sergeant who explained that his unit had been hit. He identified a location in Nasiriyah a few kilometers away. The marines arranged medical evacuation of wounded Army soldiers and retrieved an unfired .50-caliber machine gun from one of the wrecked Army trucks.

The Army vehicles were from the 507th Maintenance Company, a unit organic to a Patriot battalion. It was equipped with High-Mobility, Multipurpose Wheeled Vehicles (HMMWVs), 2.5-ton trucks, and 10-ton wreckers, some pulling trailers. During the offroad march north from Kuwait, the company had experienced breakdowns and had become bogged down in sand. As a result, it began to lose contact with the long column of Army vehicles advancing west of the Euphrates River. The company commander, Captain Troy Kent King, split his unit into two elements, one formed of vehicles that could still keep the pace and one formed of vehicles that were lagging behind. He remained with the slower element.

Captain King had received a CD-ROM that contained orders and information on his route of march.¹¹ According to the orders, the 507th Maintenance Company was to proceed along Route Blue (Highway 8) to Route Jackson (Highway 1). To navi-

¹¹ See U.S. Department of the Army, U.S. Army Official Report on 507th Maintenance Co.: An Nasiriyah, Iraq, Washington, D.C.: GPO, 2003.

Figure 4.5
An Nasiriyah, Iraq

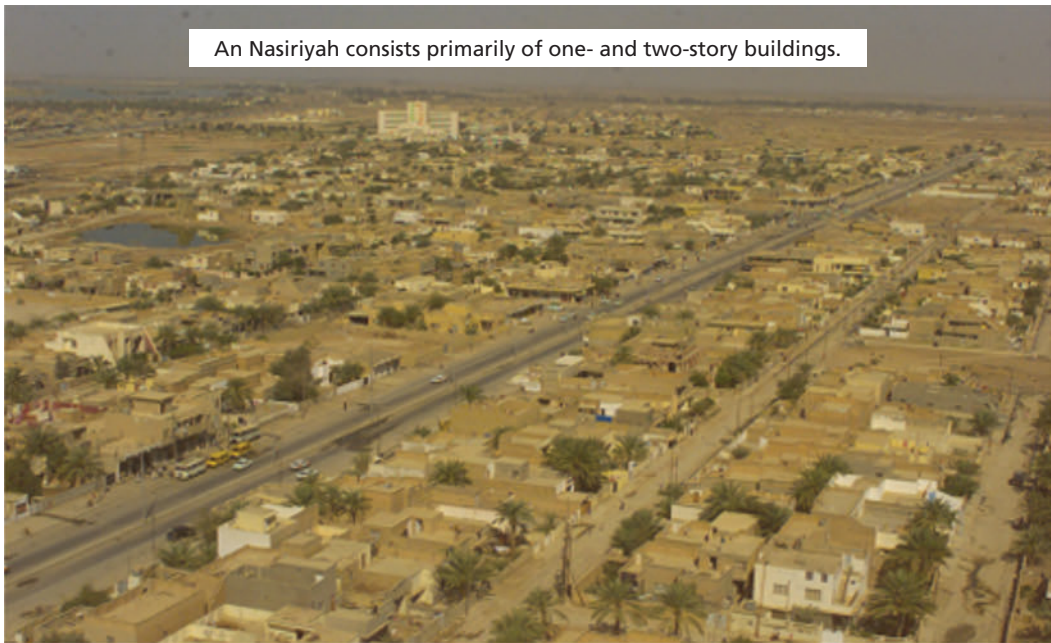

RAND MG641-4.5

gate, Captain King relied primarily on his Global Positioning System (GPS) and an annotated map. On this map, he highlighted only Route Blue, which he erroneously thought to be his only route. According to the orders, there would be a checkpoint at the junction of Route Blue and Route Jackson, but when the company arrived at this location, the checkpoint had already been dismantled. At an intersection south of Nasiriyah, Route Blue (Highway 8) required a left turn, but Captain King chose to continue north on a road confusingly marked Highway 7/8. His convoy consisted of 33 soldiers, all but two from his own 507th Maintenance Company, mounted in 18 vehicles. Figure 4.6 depicts the 507th Maintenance Company's journey across the Euphrates on the morning of March 23.

The convoy turned back onto Highway 16, where it began to receive sporadic small arms fire. The convoy increased its speed to escape the fire. While driving rapidly, Captain King missed the intersection with Highway 7/8 and continued east on Highway 16. All of the vehicles in the convoy followed his lead and passed the intersection. To regain Highway 7/8, the convoy made a U-turn. During this maneuver, a 10-ton wrecker became mired in sand and was abandoned. In the confusion, the convoy became divided into three groups. Captain King had the lead group, which included three vehicles and six soldiers. The second group, eventually led by Sergeant

Figure 4.6
The 507th Maintenance Company Travels Up and Down “Ambush Alley,” March 23, 2003

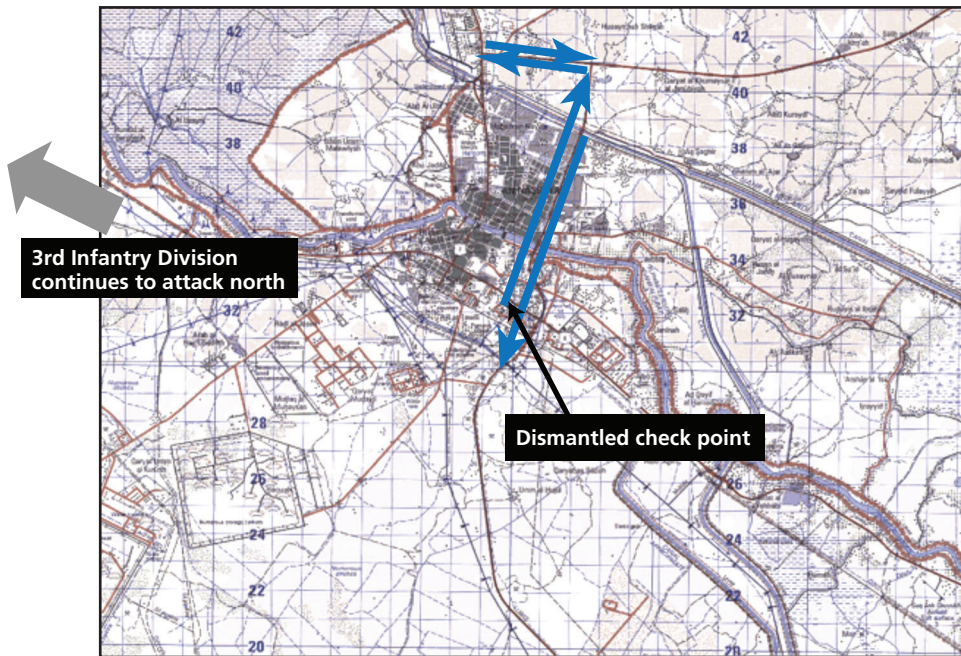

RAND MG641-4.6

Matthew Rose, included five vehicles and ten soldiers. The last group, led by 1st Sergeant Robert Dowdy, included nine vehicles (one in tow) and 17 soldiers.

As the convoy crossed over the Saddam Canal and entered Nasiriyah now in broad daylight, it came under fire from both sides of the road. Iraqis attempted to block the road with vehicles, tires, and debris. The soldiers in Captain King's group attempted to return fire but most of their weapons malfunctioned, apparently due to dirt and dust. Even so, this group successfully passed through An Nasiriyah and continued south, eventually meeting marines in Task Force Tarawa's 8th Tank Battalion. Captain King told the marines what had happened to his unit. The tankers immediately started north to assist the soldiers.

The second group also succeeded in passing through the gauntlet, but its vehicles, still under fire, stopped short of rejoining Captain King. One of the soldiers attempted to return fire with the convoy's only .50 caliber machine gun, but it also malfunctioned. The other vehicles assembled near a disabled tractor-trailer and the soldiers dismounted to form a defensive perimeter. Sergeant Rose assumed control of the ten soldiers, five of whom were wounded. The soldiers heard the sound of armored vehicles approaching their position. Fortunately, these were the Marine Corps tanks, which suppressed enemy fire with their main guns.

The third group of vehicles was attacked and badly damaged by enemy fire. It was on the road between the bridges. When its members attempted to return fire, their weapons misfired, including their M-16 rifles and an M-249 light machine gun. PFC Lori Piestewa was driving a HMMWV when a tractor-trailer veered ahead of her. She crashed into the trailer and her vehicle dove under it. Her frontseat passenger, First Sergeant Dowdy, died instantly and Piestewa died hours later. Her backseat passenger, PFC Jessica Lynch, was badly injured. Eleven soldiers were killed and seven taken prisoner by the Iraqis. The Al Jazeera television network showed pictures of dead and captured American soldiers hours after the engagement.

The action involving the 507th Maintenance Company had important consequences for the battle that followed. Brigadier General Richard Natonski, the commander of Task Force Tarawa, ordered the 1st Battalion, 2nd Marines, his only mechanized force, to accelerate its attack through An Nasiriyah. He wanted to seize the bridges intact and also to assist any soldiers from the 507th Maintenance Company who might still be alive.¹² By this time, the Iraqis were fully alerted to the possibility of a U.S. attack and they were emboldened by their successes against the 507th. Apparently unable to distinguish a maintenance company from a combat unit, they actually believed that they had repulsed an American attack. A prominent Iraqi general officer said later: “The battle of Nasiriyah and the many [American] deaths and prisoners in the hands of militias—the morale was high. You can’t imagine how high it was.”¹³

The Battle for the Bridges. The Marine Corps entered An Nasiriyah expecting to encounter resistance from the Fedayeen. While still at sea, they had been told that these forces ranked just beneath the Republican Guards in Iraq’s force structure. However, they wondered how they would be able to distinguish Fedayeen “technicals” from vehicles driven by U.S. special operations forces. After destroying seven T-55s near the railway bridge south of Nasiriyah, the marines continued north toward the bridge over the Euphrates on Route 7, entering a stretch of road they already called “Ambush Alley.”

It was mid-morning when the 1st Battalion, 2nd Marines, approached the first bridge. Just at this crucial time, the lead tanks ran low on fuel and withdrew several miles south of the city to refuel. Across the bridge, the Iraqis were waiting with a miscellany of forces that included some regular soldiers, Al Quds reservists, and Fedayeen determined to repeat their success. First over the bridge was Company B. As its vehicles entered the city, they came under heavy fire. The B Company forward air controller called in a flight of AH-1W Cobra helicopters and a flight of F/A-18D Hornets against Iraqi tanks. The ensuing firefight delayed Company B long enough for four tanks to

¹² Brigadier General (USMC) Richard F. Natonski, Commanding General, 2nd Marine Expeditionary Brigade and Task Force Tarawa, interview with RAND staff, Camp Lejeune, North Carolina, October 4, 2004.

¹³ Transcript of interview with Lieutenant General Raad Al-Hamdani for an episode of the PBS program *Frontline* entitled “The Invasion of Iraq,” first aired February 26, 2004. As of August 2007: <http://www.pbs.org/wgbh/pages/frontline/shows/invasion/interviews/raad.html>

rejoin the company. The plan was to maneuver eastward and to approach the bridge from the east rather than from the south. At the second crossroad past the Euphrates, Company B moved east onto what appeared to be solid ground, but two of its four tanks, two amphibious assault vehicles (AAVs), and several HMMWVs quickly became stuck in deep mud. (See Figure 4.7.)

Company B secured the streets on either side of its position while awaiting a tank retriever to extract the mired vehicles. The marines worked their way through the streets by squads, occasionally taking fire from small arms and rocket-propelled grenades without suffering casualties. The marines observed Iraqis operating a “technical,” a pickup truck with a 12.7mm machine gun mounted in the bed. The technical was running down a road parallel with the marines’ advance and would fire whenever it reached an intersection. The marines waited for it to appear at the next intersection and when it did, they destroyed it. During a lull in the fighting, Iraqis began bringing their wounded to the marines for treatment. The marines noted that the wounded were

Figure 4.7
The Battle for the Bridges: An Nasiriyah, March 23

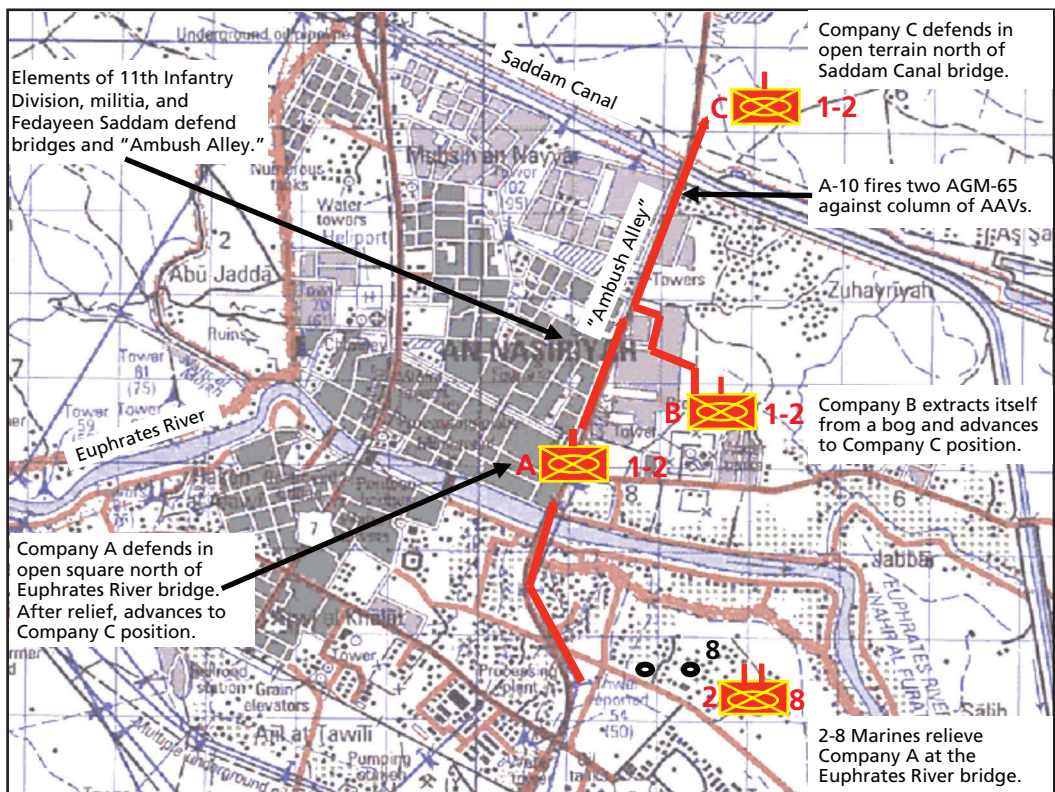

all males of military age.¹⁴ Eventually, a tank retriever arrived and extracted the tanks from the mud before becoming stuck itself. As darkness began to fall, Company B left the retriever and two HMMWVs bogged down in the mud and started up Ambush Alley toward the canal.

Next in line was Company A, whose mission was to secure the bridge over the Euphrates River. Shortly after noon, Company A crossed over this bridge and took up positions in an open square about 100 meters to the north. The company quickly came under fire from small arms and rocket-propelled grenades. Marines dismounted from their thin-skinned AAVs, but their gunners continued to use the turret-mounted .50 caliber machine guns and Mark-19 40mm grenade launchers (this version of the AAV-7 was referred to as an “up-gun”). Shortly after it reached this position, Company C passed through at high speed, heading up Ambush Alley to seize the canal bridge. Company A spent the afternoon returning fire and defending against civilian vehicles that approached its positions. Some vehicles contained fighting men and others innocent civilians. The marines often had no way to discriminate between the two. The Iraqi fighters seemed to have an endless supply of ammunition and they dodged about among the houses, making it difficult to hit them. Iraqi civilians complicated the fight by strolling past, as though unperturbed by the gunfire.

Around 2:00 P.M., while the firefight was at its peak, four tanks from Company A, 8th Tank Battalion, returned from refueling and crossed the Euphrates bridge into Company A’s position. The tankers used their 120mm cannon to blast Iraqi positions that had withstood smaller-caliber weapons. In addition, AH-1W helicopters fired at houses closest to the Marine Corps positions. Company A also came under mortar fire, but some of the rounds still had their safety pins inserted and dropped harmlessly among the marines. An AAV from Company C suddenly appeared in Ambush Alley, dragging its ramp and smoldering. It had just reached Company A’s location when a rocket-propelled grenade struck the vehicle and ignited ammunition causing a catastrophic explosion. Company A extracted two wounded marines from the AAV. They were evacuated by a CH-46E helicopter, which landed despite persistent automatic weapons fire and incoming mortar rounds.

At about 4:00 P.M., Company A started north toward the canal bridge. Earlier, two of the tanks had started up the road alone, toward Company C’s location at the northern bridge. Company A proceeded up Ambush Alley as fast as possible, firing all the way. By this time, the marines had given up trying to distinguish between Iraqi civilians and Iraqi paramilitaries wearing civilian clothing. They simply fired on houses and alleyways all along the route. On its way, Company A recovered wounded marines from a disabled AAV at the side of the road and also retrieved its .50 caliber machine

¹⁴ Gary Livingston, *An Nasiriyah, The Fight for the Bridges*, North Topsail Island, NC: Caisson Press, 2004, p. 63.

gun. It reached Company C's position north of the canal a few minutes later. By this time the battle had died down and there was little firing during the night.

According to the original plan, Company C would follow Company B to the day's final objective, the bridge over the Saddam Canal (Figure 4.8). But when Company B maneuvered to the east, Company C became the lead element of 1st Battalion, 2nd Marines. The company—with no supporting tanks—had proceeded straight up Ambush Alley, a two-lane highway with a traffic divider in the center running through the eastern side of Nasiriyah. The terrain was fairly open just north of the Euphrates, but further along there were houses on both sides of the road. As a result, the men in Company C could not see Company B and assumed that it was still ahead of them. Shortly after passing the square that Company A was defending, Company C came under fire from machine guns and rocket-propelled grenade launchers on both sides of the road. Several times, Company C stopped and maneuvered its vehicles obliquely in a herringbone pattern to return fire. The farther Company C advanced, the more intense the enemy fire became. Some marines fired their M-16s from the top hatches of the AAVs. About 200 meters south of the canal, one of the AAVs was hit by a rocket-propelled grenade and caught fire. The grenade ignited an AT-4 round, which exploded within the vehicle. The driver was wounded in the explosion but managed to pass over the canal bridge. A tall column of smoke rose from the damaged vehicle, giving Iraqi gunners an easy target.

Fratricide Incident at the Saddam Canal. North of the Saddam Canal, Company C was in open terrain without houses or vegetation beyond a few low bushes. The terrain was mostly flat with the slightly elevated highway the most prominent

Figure 4.8
The Bridges of An Nasiriyah



Note the open terrain off of the Saddam Canal.

feature. There were drainage ditches on the sides of the highway that offered cover. No sooner had they arrived than the marines began taking hits from mortars, recoilless rifles, machine guns, and rocket-propelled grenades fired from the city southwest of the canal. In addition, they began taking indirect fire from Iraqis located to the northeast. At first, Company C had only its own 60mm mortars for indirect fire, because it had lost radio contact with the artillery battalion that was supposed to provide direct support, namely the 1st Battalion, 10th Marine Artillery, which was deployed south of the city. The company mortar section began returning fire as fast as the men could drop rounds into the tubes, trying to knock out the Iraqi mortars. An enemy artillery round killed two marines. Mortar rounds began landing short and long of the mortar section's position, suggesting that Iraqis had found the range. A round landed within their position, killing three marines, including the artillery forward observer, and wounding several others, including the commander of the weapons platoon.

At about the same time, Company C came under attack from a flight of A-10 aircraft. This friendly fire incident occurred as the result of an unfortunate chain of events. The battalion air officer was off the air net because of an inoperative radio. Company C, originally the last company in line, had no forward air controller. As a result, the forward air controller with Company B (call sign Mouth) was the only one in position to control close air support. The commander of Company B directed him to call in air attacks on Iraqi forces to the north and assured him that Company B was in the lead ("lead trace"). Mouth acquired a flight of A-10s (call signs Gyrate 73 and 74). He spent about 15 minutes acquainting the A-10 pilots with the situation on the ground. He informed them that no friendly forces were north of the canal. Mouth felt confident of this information because his company had been in the lead and he had not seen any Marine Corps forces pass it. Mouth did not verify this information with the battalion commander, as normally required when the forward air controller can observe neither the attacking aircraft nor their targets, because communications were extremely poor and he believed that rapid action was essential to save lives.¹⁵

Mouth cleared Gyrate 73 and 74 to attack targets north of the Saddam Canal in the vicinity of the northern bridge. He directed that they conduct their runs east to west to avoid flying over Marine Corps forces in An Nasiriyah. From his position in the city, Mouth could intermittently see the A-10 aircraft, but not the target area. Company C was deployed in open desert terrain in bright daylight and the A-10 pilots were flying low for gun runs, yet they failed to recognize AAVs despite their distinctive appearance. They initially attacked Company C with Mk-82 gravity bombs and then with 30mm cannon fire. Several marines on the ground immediately recognized the sound of the 30mm cannon and realized they were under friendly fire. They displayed

¹⁵ U.S. CENTCOM, "Memorandum, Subject: Investigation of Suspected Friendly Fire Incident Near An Nasiriyah, Iraq, 23 March 2003," MacDill Air Force Base, Florida, March 6, 2004; see statement of Captain [name expunged], forward air controller, Company B, 1st Battalion, 2nd Marine Regiment, Task Force Tarawa, April 23, 2003.

panels and fired flares, but neither of these actions attracted the pilots' attention. In all, the pilots conducted six strafing runs.

Because there was little cover and the area was swept by enemy fire, medical evacuation by helicopter was too risky (see Figure 4.9). Instead, Company C attempted to evacuate its wounded by running five AAVs south through Ambush Alley. The A-10 pilots naturally interpreted this movement as an Iraqi armored attack on the marines and fired a Maverick against the lead vehicles. An AAV carrying mortar ammunition exploded catastrophically, killing the marines inside. Only the driver and gunner managed to exit before the explosion. Another AAV was struck on the rear ramp, causing it to fall and drag on the highway. As noted above, this vehicle eventually reached Company A's position, where it was totally destroyed by rocket-propelled grenades. Two of five AAVs successfully ran the gauntlet and brought their casualties to the battalion aid station. The subsequent investigation could not determine precisely how many marines died from friendly fire, because there was such a high volume of both enemy and friendly fire. Shortly after the Maverick run, Company C succeeded in contacting the battalion, which contacted the fire support team with Company B, which directed the

Figure 4.9
Company C, 1-2 Marines at the Saddam Canal



forward air controller to stop (“check”) the A-10 fire.¹⁶ The fifth AAV was disabled by fire and crashed into a house.

Marines ran out of the disabled AAV, which had crashed into the house about 800 meters south of the canal. They scaled an eight-foot wall and sought refuge in a house. The flat roof of that house was ringed by a four-foot concrete wall, which provided an excellent firing position. The marines cleared the house and prepared to make a stand. Iraqis swarmed around the house in a scene reminiscent of “Blackhawk Down,” a film all too familiar to most of the marines (and to many Iraqis). Eventually there were 29 marines in the house, the highest-ranking being lance corporals. So long as their ammunition held out, they could successfully defend the position in daylight, but they feared being overrun when night came. Several hours after they had entered the house, they saw Company A headed north, firing as it went. They also saw an 81mm mortar platoon and the battalion’s anti-armor team go past without noticing them. But shortly thereafter a HMMWV stopped at the house. In this vehicle was Gunnery Sergeant Jason Doran, firing a combat shotgun from the passenger-side window. Doran had organized a rescue team mounted in five HMMWVs. He brought most of the marines to safety in the new battalion position north of the canal. When he discovered that a few men had somehow been left behind, he returned a second time to retrieve them.

Late in the afternoon, the men of Company C heard approaching armor and feared it might be Iraqi. Had the Iraqis brought tanks into the fight at this time, they might have overrun Company C. Fortunately, the tanks were the two M-1s from the 8th Tank Battalion that had departed on their own from Company A’s position at the southern bridge and made their way up Ambush Alley. They were, needless to say, a very welcome sight to the men of Company C. The tankers crossed the canal and turned toward the city lying across the canal to the south. With their main guns, the tankers blasted apart the buildings in which Iraqi firing positions were located, silencing much of the fire. Had they been present from the start, Company C would have fared much better.

Air forces played an important role during the battle for the bridges. During the day, Marine Corps air flew 35 fixed-wing and 27 rotary-wing sorties in close support, plus 15 sorties to evacuate casualties.¹⁷ AH-1W attack helicopters supported both Company A at the river bridge and, during the late afternoon, Company C at the canal bridge.

By the end of the day, Company C had lost seven of its 12 AAVs and had suffered 18 killed and 36 wounded. Even so, the company was fortunate that the Iraqis were

¹⁶ Although the AAV-7 is a large vehicle with a distinctive profile, it is likely that the Air Force A-10 pilots had never seen these vehicles before, since it is rare for the Air Force to exercise with Marine Corps units.

¹⁷ Headquarters, 2nd Marine Expeditionary Brigade, *Chronicle of the Combat Actions at Nasiriyah*, Camp Lejeune, North Carolina, 2003, p. 10.

poor shots and ill-trained. In the opinion of 1st Sergeant Jose Henao, the Iraqis could have killed the whole company had they used their weapons more competently.¹⁸ Company C accomplished its mission, but at great cost. Brigadier General Natonski said of the bridges at An Nasiriyah: “These are the most expensive bridges in Iraq. Marines died for them.”¹⁹

The battle for the northern bridge would have gone much better if Company C had had tanks supporting its initial advance. Tanks could have suppressed enemy fire in Ambush Alley and silenced Iraqi gunners firing into the marines’ position north of the canal. Things would have gone better if Company C had had its own forward air controller. The marines also lacked a suitable infantry carrier. AAVs were developed for amphibious landings, not for protracted land combat. The AAV is a bulky, thin-skinned vehicle easily pierced by rocket-propelled grenades; it lacks the heavy, accurate firepower of the Bradley fighting vehicle’s 25mm cannon. Conversations with several marines revealed that although they like the “up-gun” variant of the AAV-7 that includes the .50 caliber and a 40mm grenade launcher, they recognized that the stabilized 25mm gun on the Bradley (the same armament used on the Marine Corps Light Armored Vehicle–I) is a superior weapon. Finally, poor communications were a great source of trouble. Because of poor communications, Company B did not know where Company C was located and the battalion air officer was unable to use the air net. Had communications been better, the friendly fire incident would not have occurred.

Securing An Nasiriyah. Early on March 24, 1-2 Marines defeated an enemy counterattack near the “T” intersection north of the canal bridge seized the previous day. The marines attacked north and overran the headquarters of the Iraqi 23rd Infantry Brigade to the north. Around noon, the 1-2 Marines seized the bridge and “T” intersection across the canal northwest of Nasiriyah, isolating the city. Shortly afterward, 2-8 Marines, who had relieved Company A, 1-2 Marines, at the southeastern Euphrates bridge, engaged Iraqi forces in the vicinity of the Dhi Qar Hospital on the southern bank of the river. About 2:00 P.M., the 2nd Light Armor Reconnaissance Battalion, a lead element of 1st Marine Division passed through Ambush Alley without incident. Just before midnight, the lead battalion of Regimental Combat Team–1, 1st Marine Division, began the same passage. Iraqi forces in Nasiriyah offered less and less resistance to this passage and the marines suffered no losses. During the day, artillery conducted numerous counter-fire missions against Iraqi weapons in the city. Because their gun positions were so close to the targets, marine gunners often had to shift the trails. Artillery supported the passage of Marine Corps forces by firing rolling barrages ahead of the advancing column. It was during this period that a battery of British 105mm Light Guns appeared in the area south of the city and offered their support.

¹⁸ Headquarters, 2nd Marine Expeditionary Brigade, p. 97.

¹⁹ Natonski interview.

1-10 Marines incorporated the British into their firing. The British battery remained on station for several days.

On March 25, a severe sandstorm struck the Nasiriyah area. The heavy dust and high winds severely impeded rotary-wing operations. During the storm, 2-8 Marines occupied the Dhi Qar Hospital southeast of the city, where they found large amounts of weapons, ammunition, communications equipment, and protective gear against nuclear, biological, and chemical weapons. This misuse of a hospital to store military supplies was but one incident in a general pattern of misusing schools, hospitals, and mosques for military purposes. Prior to the invasion, the Iraqis had deliberately stored military supplies in such places, expecting that U.S. forces would not attack them. In the Dhi Qar Hospital, the marines also found evidence that U.S. Army personnel had been treated, including PFC Jessica Lynch's uniform blouse with her nametag. South of the city, 3-2 Marines secured a sector along the main supply route. The marines saw five civilian buses arriving from Basrah carrying 120 young males who had short, military-style haircuts. The marines decided to treat these men as prisoners of war.

On March 26, the continuing sandstorm prevented rotary-wing aircraft from providing close air support, but they still flew reconnaissance missions. Fixed-wing aircraft continued to fly close support, and AC-130 aircraft began to attack targets within the city. 1-10 Marines fired 132 rounds of high explosive and Dual Purpose Improved Conventional Munition (DPICM) on the railway station south of the Euphrates, which was serving as an assembly area for Iraqi forces. 3-2 Marines seized a Ba'ath Party headquarters building south of the city and garnered intelligence on Iraqi preparations to defend An Nasiriyah. There were numerous engagements during the day in which Iraqis employed BM-21 rocket launchers, D-30 howitzers, and ZSU air defense guns in the ground role, plus technical vehicles.

The following day, Lieutenant General James T. Conway declared Task Force Tarawa to be the Marine Corps' main effort and reinforced Tarawa with the 15th Marine Expeditionary Unit and the 26th Marine Expeditionary Unit. Tarawa's mission was to isolate An Nasiriyah and to expel enemy forces. Tarawa began to work with Army Special Forces to develop targets within the city, especially those associated with the Ba'ath Party and the Fedayeen. During March 27–29, Tarawa directed fixed-wing air strikes on such targets within the city. Marine forces still remained outside the built-up area but continued to suffer casualties from Iraqi indirect and direct-fire weapons. The combat engineer company built obstacles at several locations southeast of An Nasiriyah to block Iraqi infiltration from the south. On March 28, the Marine Corps finally recovered six bodies from one of the AAVs destroyed in Ambush Alley five days earlier. This AAV had received a direct hit from a rocket-propelled grenade that detonated mortar ammunition inside the vehicle, causing a catastrophic explosion.

The battle of An Nasiriyah lasted much longer than expected. Task Force Tarawa had planned to seize the bridges, let 1st Marine Division pass through, and advance north as the reserve of the 1st Marine Expeditionary Force. Instead, Tarawa

remained committed in the An Nasiriyah area from March 23 to April 2, depriving the 1st Marine Expeditionary Force of its reserve. Had fighting in the north been more demanding, the loss of this reserve might have become a serious problem.

What accounts for the duration of the battle for An Nasiriyah? Brigadier General Natonski, the commander of Task Force Tarawa, avoided entering the city, except as necessary to assure passage through it, because he had too few troops to occupy it. Instead, his plan was to surround the city, cut off reinforcements, especially from the Basrah area, and sap the Iraqi forces via probing actions, counter-battery fires, and air strikes. This plan succeeded and saved marine lives, as well as the lives of civilians who would have been caught in cross-fires.

The Marine Corps did what it could to minimize civilian casualties, but even so, the battle of An Nasiriyah proved destructive to civilians. The responsibility for this destruction lies with the Iraqi defenders, who abused the laws of warfare and deliberately used civilians to shield themselves. The regime not only stockpiled supplies in hospitals but also used them for military purposes, thus making them targets. The Fedayeen drove civilian vehicles and wore civilian clothes, deliberately making themselves difficult to distinguish from noncombatants. The Fedayeen and other Iraqi forces fortified houses along Ambush Alley and elsewhere, compelling the marines to shell such places. At the start of the battle, Task Force Tarawa had plotted hundreds of restricted fire areas in An Nasiriyah, but as the result of Fedayeen activity most of these restrictions had to be lifted. Essentially, the Fedayeen were trying to conduct guerrilla warfare, but they lacked the indispensable prerequisite of popular support. The inhabitants of An Nasiriyah, almost entirely Shi'ites, were strongly opposed to the regime and usually betrayed the Fedayeen when they could do so safely. Had the Fedayeen enjoyed popular support, they would have been far more difficult to suppress.

Task Force Tarawa, the Sequel. After the battle of An Nasiriyah, Task Force Tarawa went on a tour of south-central Iraq to “knock Red icons off the map,” i.e., to assure that Iraqi forces were thoroughly defeated.²⁰ After the rescue of PFC Jessica Lynch,²¹ Task Force Tarawa began moving north on Highway 1 to the vicinity of An Numaniyah and Ad Diwaniyah. On April 7, Tarawa was ordered to force the capitulation of the Iraqi 10th Infantry Division in the area of Al Amarah. Tarawa attacked with its mechanized force, 1-2 Marines, and the 24th Marine Expeditionary Unit east of Qalat Sakar and seized Al Amarah. Marines saw abandoned and destroyed Iraqi military vehicles scattered around the area, and their advance was largely uncontested.

On April 11, Task Force Tarawa attacked positions of the Baghdad Division around Al Kut and again encountered little resistance. It secured the airfield near Al Kut and improved it to support flight operations for C-130 aircraft. When Brigadier General Natonski entered Al Kut, he found that an Iraqi named Abbas had

²⁰ Natonski interview.

²¹ This operation is detailed later in this chapter.

declared himself mayor and moved into offices in the town hall. Natonski deliberately ignored Abbas, while buzzing the town hall with AH-1W attack helicopters. Eventually, the self-appointed mayor walked out of the town hall and Natonski took over. He expected the Office of Reconstruction and Humanitarian Assistance (ORHA) to assume responsibility for reconstruction and was disappointed when its representatives failed to appear.

Task Force Tarawa set up a Civil-Military Operations Center to coordinate the activities of relief organizations. It restored and rededicated the military cemetery for British soldiers who died during an ill-fated expedition in 1916. To promote good will, the marines played soccer with Iraqis, who easily dominated them. After the match, some of the Iraqi players said that they were glad that Uday Hussein was no longer around to torture or kill them if they lost.²² Task Force Tarawa used reservists who were policemen in civilian life to train Iraqi police, and it issued AK-47 assault rifles to the police.

Task Force Tarawa departed Iraq in early May on the USS *Kearsarge*. In early June, the *Kearsarge* stood off Africa, ready to conduct noncombatant evacuations from Liberia and Mauritania, while other ships carrying the 2nd Marine Expeditionary Brigade continued across the Atlantic. The *Kearsarge* finally offloaded at Onslow Beach near Camp LeJeune at the end of June and the 2nd Marine Expeditionary Brigade, except for a planning cell, was disestablished on July 11.

The 11th Attack Helicopter Regiment at Karbala (March 23). Before daylight on March 24, the 11th Attack Helicopter Regiment attacked elements of the Medina Division deployed east of Karbala. The regiment consisted of three battalions equipped with AH-64 Apaches. The 2-6 Cavalry had 21 AH-64D aircraft, the 6-6 Cavalry had 21 AH-64A aircraft, and the 1-227 Attack Helicopter Battalion had 18 AH-64D aircraft. The 2-6 Cavalry and the 6-6 Cavalry had Robeson internal auxiliary fuel tanks, which extended their range but reduced storage space for 30mm ammunition.

On March 23, the weather forecast predicted an impending sandstorm that would ground helicopters, and the regiment felt under pressure to conduct an attack before the storm began. Immediately after Brigade Combat Team 2 (BCT-2) cleared a logistics site west of An Najaf (Objective RAMS, Figure 4.10), the regiment started to establish a forward arming and refueling point (FARP) there. Less than half of the regiment's refueling and rearming assets arrived at this site in time for the mission. The site was dangerous for flight operations and not secured. Iraqi civilians wandered through the area unchallenged, and some of them may have given warning of the impending attack. The area was farmland laced with irrigation ditches that had not appeared on satellite imagery. Moreover, the helicopter blades stirred up dust from the light soil, causing "brownout," a dangerous loss of visibility. To avoid brownout, pilots sometimes used running landings, but these were dangerous given the rough ground.

²² Natonski interview.

Figure 4.10
11th Attack Helicopter Regiment Attack Route to Medina Division

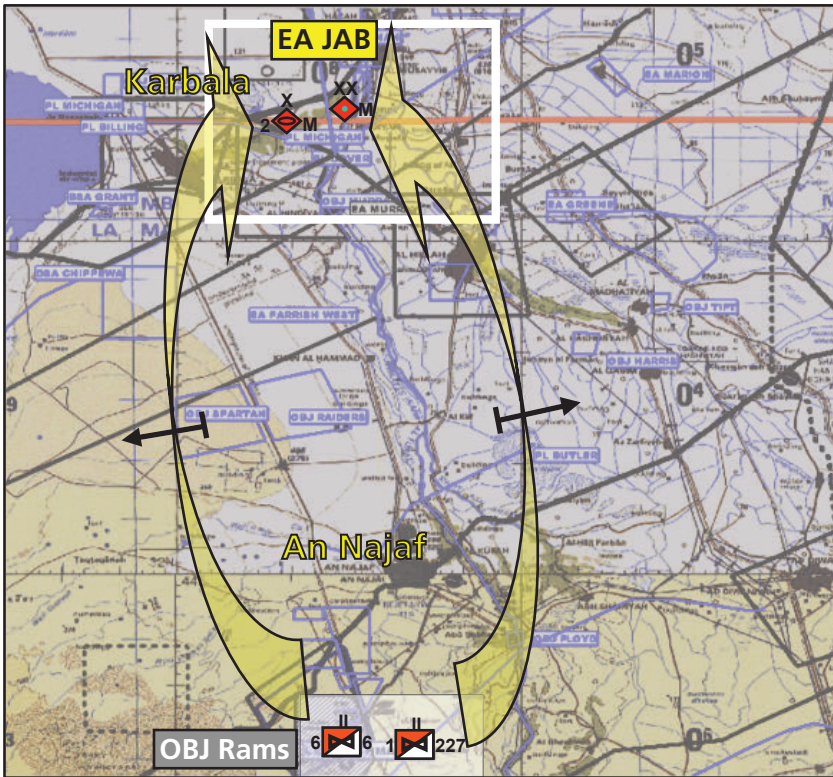

SOURCE: "V Corps, The Road to 'Victory!' in Operation Iraqi Freedom," V Corps briefing, Heidelberg, Germany, June 2003.

RAND MG641-4.10

Intelligence for the impending attack was unsatisfactory. Coverage from unmanned aerial vehicles was not available because Hunter was in transport and Predator was tasked for another mission. The regimental intelligence officer had only voice communications with the Fires and Effects Coordination Cell at the V Corps headquarters, which could provide only an estimate based on recent signals intelligence and templates, i.e., typical deployment patterns for Iraqi units. The targets were the 2nd Armored Brigade, Medina Division, and the 125th Artillery Battalion. Their locations were given as four-digit coordinates, defining grid squares one kilometer on a side. As a result, the Apache pilots would have to conduct reconnaissance over an area of at least one square kilometer.

The regiment wanted to avoid ground fire from populated areas and therefore originally planned to attack from west of Lake Bahr al-Mihr over the least-populated terrain, but V Corps had assigned this battlespace to the 101st Airborne Division.

Regimental planners repeatedly requested permission to use this space, but V Corps refused. V Corps planners argued that the western approach would require establishing another FARP, which was impractical under the circumstances. As a result, the regiment had to plan routes over numerous villages and farms between the FARP and the target area east of Karbala. All the Apaches would fly in and out on the same routes.

To suppress air defenses along these routes, the 2nd Battalion, 4th Field Artillery (214th Field Artillery Brigade) would fire 31 Army tactical missiles (ATACMS), with another 30 missiles reserved for targets of opportunity. This preparation was scheduled for 30 minutes before the arrival of the attack helicopters, a sufficient interval for defenders to recover from the shock. In addition, fighter aircraft would be on station. Unfortunately, there was little knowledge of the location of Iraqi air defense systems in the vicinity of Karbala. Suspected enemy air defense sites were identified by templating the area. Significantly, the effort to locate and target enemy air defenses focused on medium and heavy air defense systems such as vehicle-mounted SA-9s and SA-13s and anti-aircraft guns such as 23mm and 57mm weapons. No targeting was done to suppress the threat of small arms and machine guns.

In view of the difficulty of refueling in the rough terrain, takeoff was delayed for several hours. As a result, ATACMS were fired a full two hours before the attack helicopters arrived, much too long for any suppression to endure.²³ Fighters did not receive notice of the change and therefore were not on station when the attack occurred. Even if all the planned suppression of enemy air defense had been delivered optimally, it still might have had little effect. The Iraqi defenders possessed large numbers of small to medium caliber guns that could not have been suppressed without laying waste to the entire route taken by the attack helicopters. However, devastation on such a scale would have been politically infeasible and perhaps contrary to the laws of war. The United States had faced this same dilemma when contemplating attack helicopter operations from Albania into Kosovo during Operation ALLIED FORCE several years earlier. At that time the risk to the helicopters and to the noncombatants was deemed too high and the operation was never executed.

The 1-227 Attack Helicopter Battalion fueled first, and its 18 Apaches took off successfully. The 6-6 Cavalry fueled second, and only 13 of its Apaches had time to receive fuel before the regimental commander had to launch the mission. Of these, 12 took off successfully and one crashed on takeoff due to brownout. The Apaches flew low and fast without running lights during darkness, but they were silhouetted against cloud cover and their rotors made a distinctive sound that alerted the Iraqis to their presence.

As the lead helicopters entered enemy airspace, the lights of several Iraqi towns went off for several seconds, evidently as a signal of impending attack. Immediately

²³ Colonel (USA) William Wolff, Commander, 11th Attack Helicopter Regiment, interview with RAND staff, V Corps Headquarters, Heidelberg, Germany, April 7, 2004.

after the lights flickered on, Iraqis began firing from almost everywhere: buildings, cars, clusters of trees, and even open fields. The fire came from all sides of the helicopters, and they could not suppress it. The weapons operator in the front seat of an Apache wore night vision goggles, which made tracer rounds clearly visible. The pilot in the rear seat was using a first-generation forward-looking infrared system that barely supported navigation and did not help locate ground fire. As a result, the weapons operator found himself talking the pilot onto targets, an inefficient procedure. Moreover, under the rules of engagement, crews were hesitant to respond to ground fire without positively identifying targets, but positive identification was seldom possible. They could see where fire was originating but not what was located at that spot or whether there was danger of collateral damage. For the most part, the enemy gunners were firing inaccurately, but their huge volume of fire compensated for inaccuracy. The 6-6 Cavalry reached its target area but aborted the attack before engaging targets. The 1-277 Aviation also reached its target area and engaged a few targets before terminating the mission. That any damage was done to the intended target is doubtful.

Thirty-one Apaches participated in the attack and all but one returned to the FARP.²⁴ That one Apache was shot down in enemy-held territory and its crew taken prisoner.²⁵ The Apaches that returned to the FARP were riddled with holes, typically about 15–20 per aircraft. For the moment, the regiment had just one combat-ready battalion left, the 2-6 Cavalry, which had not participated in the attack. Assault rifles and machine guns caused most of the damage, but some was caused by larger caliber guns and rocket-propelled grenades. Hits occurred in every part of the Apaches, indicating that they had been under fire from every direction. Fuel tanks were punctured, hydraulic lines severed, canopies pierced, rotor blades damaged, and sensor systems rendered inoperable. Several aircraft returned with wounded crewmen aboard.

To have survived so many hits proved the resiliency of the Apaches and the courage of their pilots. But the mission also demonstrated the danger of unsupported attacks against intense ground fire. Had there been no other way to attack the Medina Division, the helicopter mission might have been justified, but fixed-wing aircraft could have attacked this division with almost complete impunity. The Apaches' advantage over fixed-wing aircraft was their ability to reconnoiter and find targets, but they could not exploit this advantage, nor even survive long, against the intense ground fire they encountered.

On March 28, the 101st Aviation Brigade conducted a deep attack with two battalions (1-101 Aviation, 2-101 Aviation). Before launching this attack, planners talked with the 11th Attack Helicopter Regiment regarding its experiences on March 24. The aircraft flew from a FARP west of An Najaf to an objective area north of Karbala. The

²⁴ Wolff interview; U.S. Army V Corps.

²⁵ On April 13, Task Force Tripoli recovered this crew and five soldiers from the 507th Maintenance Company in As Samarra north of Baghdad.

1-101 Aviation flew in a westerly arc over the desert and the lake west of Karbala, while the 2-101 Aviation flew a more direct route. The brigade planned to suppress enemy air defenses with ATACMS fires four minutes ahead of the flights, and fixed-wing aviation were on call. During a 30-minute search, the pilots could not find the intended target, the 14th Brigade of the Medina Division. However, Company A, 2-101 Aviation, sighted Iraqi armored vehicles on a highway south of Karbala. Apaches engaged these vehicles in running attacks and also passed this target to a two-ship flight of F/A-18 aircraft. Apaches alternated with Hornets in an example of joint air attack. Although 101st Aviation Brigade's attack had disappointing results, it did present a good example of successful tactics: routes chosen to minimize exposure to ground fire, suppressive fire timed just ahead of the aircrafts' arrival, running (not hovering) attacks, and cooperation with fighters. Nevertheless, after this attack by the 101st, V Corps conducted no more deep attack helicopter missions prior to the fall of Baghdad.

Attack helicopters were obviously vulnerable to ground fire. They were shot down or badly damaged by ground fire during Operations URGENT FURY (Grenada), CONTINUE HOPE (Somalia), and ANACONDA (Shah-i Kot Valley in Afghanistan). The Apache and the Cobra, however, were designed to stand off beyond the range of many air defense weapons and to survive hits. Indeed, the Apache was designed to withstand hits by Soviet 23mm anti-aircraft guns. When employed carefully, these attack helicopters are highly effective, especially in the close support role. In Iraq, the marines employed their Cobras in the reconnaissance and close support roles without losing any, although many suffered considerable damage. But attack helicopters cannot accomplish their missions or even survive against intense ground fire coming from every direction, especially not during the long exposure time involved in a deep attack over populated areas.

Combat Phase 2: Consolidation and Buildup (March 26–31)

On March 26, Brigade Combat Teams 1 and 2 (BCT-1 and BCT-2) of the 3rd Infantry Division continued to fight Iraqi irregular forces around An Najaf, isolating the city from the rest of Iraq. The same day, RCT-1 seized the Qalat Sikar Airfield on Highway 7, and the following day, RCT-5 seized the Hantush Airfield north of Ad Dinwaniyah but was ordered to retire to a more defensible position. On March 28, two Apache battalions of the 101st Airborne Division conducted their deep attack against the Iraqi 14th Mechanized Brigade, Medina Division, flying over Lake Bahr al-Mihr west of Karbala. On March 31, V Corps launched several attacks with limited objectives, including an attack by BCT-2, 3rd Infantry Division, toward a bridge on the Euphrates River west of Al Hillah, and a feint by 1st Brigade, 101st Airborne Division, toward Al Hillah. On the same day, RCT-5, 1st Marine Division, seized Hantush Airfield for the second time.

On March 29, the 101st Airborne Division relieved BCT-1 and BCT-2, 3rd Infantry Division, in the vicinity of An Najaf. Over the next four days, the division

would occupy An Najaf, ending its use by Fedayeen. Also on March 29, 2nd Brigade, 82nd Airborne Division, relieved BCT-3, 3rd Infantry Division, in the vicinity of As Samawah to the south. On March 31, the 2nd Brigade attacked into As Samawah, finally clearing the city by April 6. These actions allowed the 3rd Infantry Division to assemble all its forces for the decisive offensive into Baghdad.

Combat Phase 3: Seizure of Baghdad (April 1–14)

The last period of the campaign in the Tigris-Euphrates Valley began on April 1 when the 3rd Infantry Division began to push through the Karbala Gap between Lake Bahr al-Mihr and the Euphrates River. On April 2–3, BCT-1, 3rd Infantry Division, seized the al-Kaed bridge over the Euphrates River and held it against the largest Iraqi counterattack of the campaign, opening the way for further advance. At the same time, RCT-5 crossed the Tigris River northwest of Al Kut. On April 3, BCT-1 started an attack on the Baghdad International Airport and RCT-5 advanced to reach Al Azziziyah south of Baghdad.

The Al-Kaed Bridge (April 2–3). On April 1, the 3rd Infantry Division began to advance through the Karbala Gap just east of the city. BCT-1, supported by the 3rd ID's Aviation Brigade, led the attack toward the al-Kaed bridge (Objective PEACH) on the Euphrates River. This advance led to the single largest battle of the campaign against regular Iraqi forces. The battle would end with 3-69 Armor of BCT-1 firmly in possession of the bridgehead, opening the road to Baghdad.²⁶

As the 3rd Infantry Division began its final advance on Baghdad, it encountered resistance from conventional forces for several reasons. The best-equipped and most highly trained Iraqi forces were deployed in defense of the capital. Despite disaffection with the Ba'athist regime, their commanders felt bound by honor to offer at least some resistance to the invader. An operational pause had given these commanders several days to prepare for a battle that was obviously imminent. Finally, U.S. forces would be most vulnerable while crossing the Euphrates River and deploying out of the bridgehead. For all these reasons, the battle for Objective PEACH was intense, although U.S. forces still enjoyed combat superiority.

The mission to seize the al-Kaed bridge was given to a task force built around 3-69 Armor, commanded by Lieutenant Colonel Ernest (Rock) Marcone. The task force included two tank companies from the 3-69 Armor, two mechanized infantry companies (Company C, 2-7 Infantry and Company B, 3-7 Infantry equipped with Bradleys), an armored engineer company (Company A, 11th Engineers, mounted in M-113 vehicles), a chemical smoke platoon (also mounted in M-113 vehicles), and a chemical reconnaissance platoon. The 1-41 Field Artillery was in direct support. Addi-

²⁶ The account of the battle at Objective PEACH is based primarily on RAND interviews conducted at Fort Stewart, as well as a written narrative provided by 3-69 Armor Battalion, 3rd Infantry Division (Mechanized), Fort Stewart, Georgia.

tionally, Marcone was supported by elements of the 11th Attack Helicopter Regiment. All together, his task force comprised about 1,800 personnel, including support units.

The attack to seize the al-Kaed bridge began about 11:30 A.M. on the morning of April 2. Marcone was able to develop a detailed plan to seize the bridge. Capturing the bridge at al Kifl (Objective JENKINS) near An Najaf had provided valuable experience. For example, the 3-69 Armor appreciated where the Iraqis would probably locate the controls for demolition charges on the bridge. To prevent demolition, the task force planned artillery and air strikes near the four corners of the bridge to kill or drive away Iraqi demolition parties. Marcone planned a deliberate river crossing in the face of opposition and brought rubber boats to transport infantry and engineers across the river. Marcone and BCT-1 commander Colonel Will Grimsley assumed that if the Iraqis lost the bridge, they would launch a strong counterattack to regain it. According to intelligence, the main body of the Medina Division, an armored formation, was deployed east of the bridge. Therefore, Marcone's plan considered how to defeat an Iraqi counterattack with armored forces. Figure 4.11 is a hand-drawn map created by Lieutenant Colonel Marcone and used by him and his staff to plan the operation.

Shortly after 11:30 A.M., the task force started toward the bridge from the south with scouts in the lead. Around 1:15 P.M. the scouts made contact with enemy units, later determined to be elements of a Republican Guards reconnaissance battalion and Fedayeen. Enemy resistance held the scouts in a position on the main road leading toward the bridge. The task force called for artillery and attack helicopter support. Marcone dispatched Team A, 3-69 Armor (Captain Chuck O'Brian) with ten Abrams and four Bradleys around the right flank of the scouts with the intention of destroying the enemy force standing between the task force and the bridge. Three AH-64s flew in support of Team A as the armored vehicles maneuvered between the scouts and the Euphrates River. Soon the helicopters started to take intense small arms fire from Iraqi infantry in well-camouflaged positions. The Apache crews had difficulty seeing the enemy, who were at times firing almost directly underneath the aircraft. One Apache came under short-range fire from Iraqi machine guns hidden in the vegetation on the river bank, while hovering in the immediate vicinity of the river. Soon all three Apaches were compelled to land due to damage from enemy small arms and machine gun fire. Of these aircraft, two were able to fly away later after quick repairs, while the third aircraft had to wait for an aviation maintenance crew to arrive.

During this phase of the attack, smoke and dust from exploding artillery fire constrained the Apache crews' ability to locate the enemy. To minimize exposure to ground fire, Apache pilots flew as low as possible. But at low altitude, smoke and dust obscured the target area. To see over the clutter and smoke, the Apaches would have needed several hundred feet of altitude, making them good targets for enemy anti-aircraft guns and shoulder-fired missiles.

While Team A maneuvered to destroy the enemy blocking the road, artillery fire and air attacks were hitting the area around the bridge to drive off the defenders,

Figure 4.11
The Battle at Objective PEACH

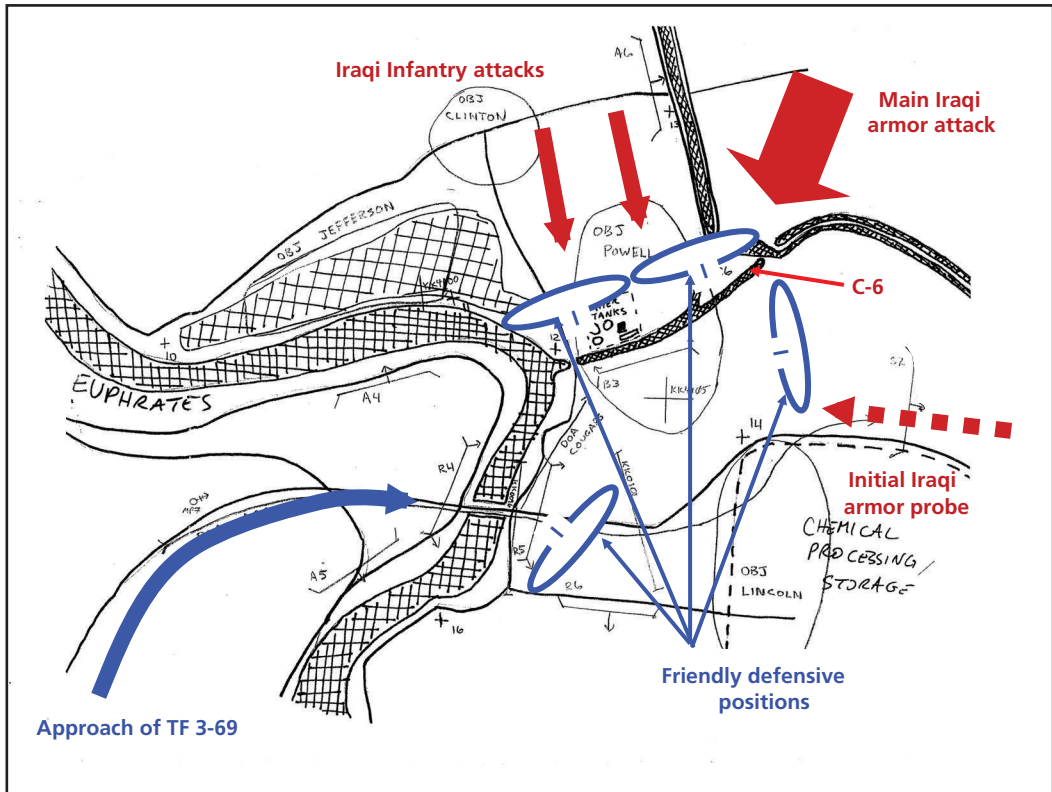

SOURCE: Drawing courtesy of LTC Ernest Marcone, at the time the commanding officer of the 3rd Battalion, 69th Armor Regiment. Annotations on the map added by the authors.

RAND MG641-4.11

especially engineers who might attempt to demolish the bridge. Fighters delivered Joint Direct Attack Munitions (JDAMs) near the four corners of the bridge, far enough away so as not to damage the structure.

By 3:00 p.m., Marcone's lead elements reached the western end of the bridge. The 1-41 Field Artillery (FA) fired a mix of high-explosive rounds against targets on the far bank of the river to suppress the enemy and smoke rounds to protect friendly forces as they arrived on the south bank. While artillery, additional Apaches, and fighter aircraft attacked Iraqi forces on the far bank of the river, engineers quickly checked the southern edge of the bridge for demolition charges. Team A, 3-69 Armor, moved to a position roughly 800 meters on the west bank north of the bridge to provide suppressive fires when the task force prepared to assault across the river. Meanwhile, the infantrymen of Company C, 2-7 Infantry (Captain T.K. Kelly), took positions near the bridge and to the south, and they engaged Iraqis on the east bank. Team C, 3-69

Armor (Captain Jared Robbins), and Team B, 3-7 Infantry (Captain Dave Benton), awaited orders to attack across the bridge.

By about 4:00 P.M., when all the conditions were set, the assault party was ready to push across the Euphrates. Since the engineers had found wires on the bridge, they had to assume the Iraqis might be able to detonate hidden charges. Therefore, rather than send armored vehicles across the bridge, Marcone decided to send infantry and engineers across the river in RB-15 rubber boats (Figure 4.12). They would secure the east bank and finish checking for demolition charges. Additional concealment was provided by the smoke platoon that had set up near the river with its M-113 and produced a haze of artificial smoke adding to the obscuration caused by the firing. At 4:15 P.M., shortly after the first troops had reached the east bank in rubber boats, the Iraqis set off demolition charges. The charges blew a large crater in the southern lane of the bridge, but the bridge did not drop into the river. The northern lane remained intact. The engineers quickly searched for remaining wires around the bridge, cutting any that they found. When the southern lane was declared safe, Team C, 3-69 Armor, Team C, 2-7 Infantry, and Team B, 3-7 Infantry, assaulted over the bridge.

Figure 4.12
Crossing the Euphrates at Objective PEACH



SOURCE: Photograph by Lieutenant Colonel Ernest (Rock) Marcone, used here by permission.

When they reached the far bank, Team C, 2-7, Infantry, picked up the infantry that had assaulted the bridge by boat. Team C, 3-69 Armor, went over the bridge next.

After crossing, the tanks and infantry expanded the bridgehead on the east bank of the Euphrates. Vehicle commanders and small unit leaders maneuvered cautiously because the ground was soft. In many areas, the vehicles could move only on roads. As the units pushed eastward from the bridge, they continued to encounter resistance from Fedayeen and Republican Guard troops fighting from prepared positions. Teams B, 3-7, and A, 3-69, moved northeastward to secure the bridge over the canal that flowed into the Euphrates. Meanwhile, Team C, 2-7, and the engineer company mopped up the area around the river bridge, clearing enemy troops from trenches, bunkers, and foxholes.

While the crossing was still under way, the Iraqis launched an intense artillery barrage. Most of this fire fell on Team A, 3-69 Armor, which remained on the west bank a few hundred meters north of the river bridge in an overwatching position. The initial enemy salvo, probably from a battalion of 152mm howitzers, impacted directly on Team A's position. From his command post located near the bridge, Marcone thought that at least a dozen large shells had landed in the initial salvo, indicating that an Iraqi artillery battalion was in action. The explosions hurled huge palm trees high into the air. Additional volleys of enemy fire crashed into the area. Some of the armored vehicles took direct hits from what appeared to be 120mm mortar rounds. Fortunately, the armor of the Abrams and of the Bradley prevented injury to the crews. To escape the fire, Captain O'Brian quickly repositioned his unit to the north. Most of Team A's vehicles suffered slight damage from fragmentation, but all remained operable. Colonel Grimsley, who had just arrived in the vicinity of the bridge, observed the enemy fire and considered it very heavy. Several hundred rounds fell on Team A's original position. Fortunately, the armor protection of the heavy vehicles, and Captain O'Brian's decision to move out of the area immediately, minimized U.S. casualties from the Iraqi fire.

Due to the severity of the Iraqi fire, Marcone ordered that all the task force's unarmored vehicles temporarily move several hundred meters to the south. The enemy guns were firing unchecked because the Q-36 counter-fire radar was inoperable, and therefore the 1-41 FA had no means to quickly locate the Iraqi weapons. Division Artillery moved a Q-37 radar into the area to find the Iraqi guns that were continuing to fire around the bridge. Fortunately, the Iraqi firing lost accuracy after Team A redeployed. Some of the salvos landed close to the bridge, but others fell in the river. This fire threatened the smoke platoon that was dangerously close to the impact zone. But the troops of the smoke platoon from the 5-92 Chemical Company stood their ground and continued to pour smoke into the area around the bridge, concealing friendly forces from direct observation. Marcone directed his air liaison officer (ALO) to have fixed-wing aircraft find and destroy the Iraqi artillery. But the Iraqis continued to fire until Division Artillery located the enemy weapons with a Q-37 and initiated counter-fire

with rockets and cannons. The Iraqi artillery barrage lasted over an hour before U.S. counter-fire stopped it. Task Force 3-69 Armor continued to receive sporadic enemy mortar fire until roughly 8:00 p.m.

The task force fought to expand its bridgehead into the early evening. An examination of data from Force XXI Bottle Command Brigade and Below (FBCB2; the Blue Force Tracker component) showed that BCT-2 was not going to reach the bridge anytime soon. Expecting a counterattack during the night, Marcone deployed his task force in a semicircular battle position on the east bank (Figure 4.11). Northeast of the al-Kaed bridge was a canal running east-west. Two bridges crossed this canal. Team A, 3-69 Armor, and Team B, 3-7 Infantry, were positioned north of the canal oriented to the north. To the east and southeast of the bridge was open terrain, although there were areas where tracked vehicles could not leave the roads because of marshy ground. The best approach for enemy armor appeared to be from the east, near the C6 road junction about eight kilometers east of the bridge. Here Marcone placed Team C, 3-69. Team C, 2-7 Infantry, was the task force reserve, located near the bridge along with the engineer company. As the maneuver units moved into their assigned positions, the 1-41 FA moved closer to the bridge in order to extend its range east of the Euphrates River. Battery B moved across to the east bank of the river, while Batteries A and C remained west of the bridge.

Marcone envisioned two defensive belts around his perimeter. The inner belt was the direct fire from small arms, infantry fighting vehicles and tanks, supplemented by mortars and attack helicopters. The outer belt (the task force's deep fight) was artillery fire and attacks by fixed-wing aircraft. The scout platoon was split into three sections, with a long-range advanced surveillance system (LRAS) going to each of the three forward deployed company teams. The air liaison officer, Air Force Captain Shawn McGann, was located with the artillery about 10 kilometers to the west of the C6 road junction, while the enlisted terminal air controller (ETAC), Air Force Staff Sergeant Travis Crosby, was with Team C, 3-69 Armor, to control close air support.

Shortly before 9:00 p.m., Marcone received signals intelligence that enemy infantry were moving south from the Baghdad International Airport toward his position. This was one of the few times during the campaign that he received useful intelligence from higher-level sources. The enemy was identified as a brigade of the Special Republican Guard, a far more skilled opponent than the Fedayeen. However, little was known about the enemy's actual strength and intention.

The first enemy probes started after 9:00 p.m. Enemy infantry, dismounted and in trucks, started advancing toward the canal from the north supported by sporadic mortar fire. Team A, 3-69 Armor, and Team B, 3-7 Infantry, engaged the enemy with direct fire and artillery fire. These fires broke up the attacks, but enemy infantry continued to infiltrate friendly positions north of the canal.

Despite heavy losses, some of the Iraqi infantry eventually closed with Team A, 3-69 Armor, and Team B, 3-7 Infantry. At one point, two platoons of Team A were overrun by enemy infantry, and the Abrams tanks had to use their machine guns to fire toward each other to sweep enemy troops away. Team C, 3-69 Armor, was also engaging enemy infantry and light vehicles approaching from the north. The tanks destroyed several trucks with 120mm fire, and the ammunition they were carrying exploded. Enemy infantry used vegetation to close within 200 meters and fire rocket-propelled grenades at Team C, 3-69 Armor. All three teams called in artillery and mortar fire, the mortars firing close to their maximum range from their location near the bridge. These infantry attacks were repeated from 9:00 P.M. on April 2 until roughly 3:00 A.M. on April 3.

The task force engaged the enemy with all weapons at its disposal, including the rifles and machine guns of the dismounted infantry. Every ten to fifteen minutes a few Iraqi artillery or mortar rounds impacted near U.S. vehicles. Meanwhile, the two platoons of Team C, 3-69 Armor, which were facing south and east, saw no action. When the attacks abated, leaders checked their men and cross-leveled ammunition among the squads and fighting vehicles. Team C, 3-69 Armor, was then split into two elements, based on its two tank platoons. To the north around the bridge over the canal was one tank platoon, a section of Bradleys, a fire support team, the company commander's tank, and the Air Force ETAC. To the south was the other tank platoon, another squad of infantry in Bradleys, and other company tanks. Captain Robbins, the company commander, stayed with the northern group, while the company executive officer, Lieutenant Mike Jones, was posted with the southern element. Marcone told the company commander that he was prepared to commit the task force reserve into his sector if the situation required it, keeping a minimal force near the bridge.

Shortly after 2:00 A.M., Iraqi tanks approached from the southeast. This was the vanguard of the 10th Armored Brigade of the Medina Division. Intelligence on the enemy column's movement had not been relayed to Marcone, thus giving the enemy the advantage of tactical surprise. When the lead enemy tank was about 1,500 meters from the U.S. positions, two Team C tanks simultaneously fired 120mm sabot rounds. These knocked the enemy tank out, although it did not explode. When the lead tank was destroyed, the following Iraqi armor turned north and went out of sight. Around 2:30 A.M., Iraqi armor appeared in front of 2nd Platoon, Team C, which engaged them with 120mm HEAT rounds at about 1,500 meters, knocking out two enemy T-72 tanks, but more enemy armor appeared.

By 3:00 A.M., Team C was engaging T-72 tanks, BMP infantry fighting vehicles, and M-113 armored personnel carriers approaching from the east and northeast. Iraqi infantry started to dismount from their carriers and advance toward the U.S. positions using much better tactics than displayed by the Fedayeen. The commander of Team C called for artillery and air support. Attack helicopters arrived on station and fired on the attacking Iraqi forces. By this point in the campaign, the 3rd Infantry Division had

prohibited helicopter operations beyond the Euphrates River. The Apache pilots told Marcone of this prohibition, but he needed their support. He asked them to cross the river and hover over friendly positions while they fired. The pilots accepted this request and joined the battle.

The thermal sights of the Abrams tanks and Bradley infantry fighting vehicles gave them a decisive advantage over the attackers. U.S. gunners could detect and engage Iraqi armored vehicles before the Iraqis could locate the U.S. vehicles and return fire. The generally open terrain in the area east of the bridge facilitated long-range engagements. Beyond the range of direct fire, the Iraqis were hit by air strikes and volleys of artillery delivered by the 1-41 FA. The time of flight from the artillery positions to the Iraqis' locations was 33 seconds. Knowing this, the air liaison officer, who was located with the artillery battalion, could tell fighters when they had 30 seconds to clear the area before a salvo of artillery arrived. Once an artillery fire mission was completed, the fighters could return safely.

By 5:30 A.M., the battle was over. The teams along the canal line to the north had driven off the Iraqi infantry attacks, while Team C had defeated the Iraqi armored attack. The task force estimated that over 20 T-72 tanks and some 50 BMP infantry fighting vehicles and M-113 infantry carriers were destroyed during the attack. When the sun arose on the morning of April 3, Team C, 3-69 Armor counted 14 T-72s, four BMPs, two M-113s, and ten trucks destroyed in front of its position. Fighter and attack helicopter pilots reported that they destroyed another 10–12 T-72s during the night. Later the task force discovered that elements of the 22nd Brigade of the Nebuchadnezzar Division had also participated in the battle. Some 600 enemy bodies were counted in the vicinity of the three teams that had defended the bridgehead against the largest armored attack the Iraqis attempted during the campaign. It was a decisive defeat for the Medina Division, severely weakening that unit and making it ripe for destruction when BCT-2 crossed the Euphrates over the al-Kaed bridge on April 3 and attacked southward on April 4.

Marcone's own losses were very small: no one killed in action and six to eight wounded. Rocket-propelled grenades struck several U.S. tanks, but none were knocked out. A rocket-propelled grenade penetrated one Abrams, on the left side through one of the side skirts, and damaged the tank's hydraulic system. There were no casualties from this hit, but the crew had to operate the turret and main gun manually for the rest of the campaign.

Sometime after dawn, some of soldiers from Team C went to the first tank they had knocked out at the start of the armored battle. The body of the commander of the 10th Brigade of the Medina Division lay near this tank. Apparently, he had been leading the advance personally when SABOT rounds struck his tank and he was blown out of the hatch onto the ground. From his map case, the task force recovered several documents. These revealed the order of battle and tactical dispositions of the Medina Division and the strength of the 10th Brigade before it attacked. According to these

documents, the 10th Brigade was at 80 percent strength on the morning of April 2. Apparently, it had not suffered greatly from air attacks up to that time.

Although the battle was a decisive success, intelligence on the enemy was generally poor at the tactical level. When Task Force 3-69 Armor maneuvered toward the bridge, it had little information on Iraqi forces in the area, other than that the main body of the Medina Division was located somewhere east of the bridge. BCT-1 and Task Force 3-69 Armor received little intelligence regarding enemy preparations for a counterattack. Prior to his attack toward the bridge, Marcone had asked that an unmanned aerial vehicle (UAV) sweep the route and the area around the bridge. This request was denied by the V Corps G-3 for reasons never explained to TF 3-69. Marcone did receive signals intelligence that enemy infantry forces were approaching from the north, but he had little indication of their strength.

The task force had no warning that armored vehicles were approaching its position. Marcone first learned of their approach through reports from his forward elements at the C6 road junction about six kilometers east of the bridge. Thus, an Iraqi armored force of several dozen vehicles had approached a critical bridgehead without being detected by overhead surveillance assets. Some higher-level surveillance system may have detected their approach. If so, the intelligence did not reach BCT-1 or Task Force 3-69 Armor, which detected the enemy armor only when it came within the range of U.S. tank guns. The Iraqi 10th Brigade probably marched only 15–20 kilometers from hidden positions before it reached the bridgehead, thus affording little time for detection and reporting. Once the Medina Division's counterattack was under way, Marcone requested Joint Surveillance Attack Radar System (JSTARS) support and did receive some information, relayed through his task force ALO, on what JSTARS could observe around the bridge. In the event, Task Force 3-69 compensated for inadequate intelligence by anticipating an enemy counterattack and preparing a detailed plan of defense. As always during the campaign, U.S. forces were overwhelmingly superior to the Iraqi forces in close combat.

The “Thunder Runs” (April 5 and 7). Originally the plan for operations around Baghdad had envisioned that the city would be isolated and sealed off. Indeed, the pre-D-day plans were rather vague as to what would happen once Baghdad was reached.²⁷ When U.S. forces arrived at the city, it was hoped, Saddam's regime would collapse. By April 4 considerable progress had been made toward isolating the city. The Medina Division had been destroyed south of Baghdad, most of the airport was

²⁷ Colonel (USA ret.) Gregory Fontenot, Lieutenant Colonel (USA) E.J. Degen, and Lieutenant Colonel (USA) David Tohn, *On Point: The United States Army in Operation Iraqi Freedom*, Fort Leavenworth, KS: Combat Studies Institute Press, 2004, p. 393. During prewar planning I MEF had been told that operations in and around Baghdad would be “a V Corps show,” and that only selected capabilities would be needed from the Marine Corps. I MEF and 1st Marine Division objected to this approach; they envisioned that considerable force would be needed once U.S. forces reached the city. Therefore, the Marine Corps insisted on a larger role in the final operation around Baghdad. Interviews with 1st Marine Division, Camp Pendleton, California, October 1–3, 2003.

in U.S. hands, and BCT-3 was getting ready to cross the Euphrates to make its sweep northwest of the city. On the other side of Baghdad, the 1st Marine Division was approaching from the southeast, and clearly it would soon reach the outskirts of the city. The time had come to decide whether to pause and wait for the regime to collapse or attack into the city.

There were advantages to sealing the city off and waiting for internal pressures to force the collapse of Saddam's government. For example, waiting for the city to be isolated and bringing up the main body of the 1st Marine Division on the east would maximize U.S. combat power, which would be at its peak if and when a decision was reached to launch an assault on the city. All the senior commanders wanted to maintain maximum pressure on the Iraqis at this point, realizing that they were entering the "end game" of major combat operations.

There were other operational factors that senior military leaders had to take into consideration. Despite the pause during the last week in March, the forces now approaching Baghdad were at the end of a very long logistical tether. The vast majority of supplies had to be transported overland from Kuwait to V Corps' and I MEF's forward elements, a straight-line distance well over 450 miles by this point. Already there were signs of major wear on the armored vehicles, given the severe shortage of spare parts that was common throughout the operation. Additionally, certain types of ammunition—in particular High Explosives for the artillery and multi-purpose anti-tank (MPAT) rounds for the tank guns—were in short supply in the forward units. Therefore, a pause around Baghdad, with the city encircled, would allow supply lines to replenish. However, pausing without launching offensive operations into the city could give the enemy a chance to recover and prepare defenses in that urban area.

On the night of April 4, V Corps and 3rd Infantry Division decided on a bold course of action: armored raids into Baghdad. The overall assessment was that the Iraqis had been so sufficiently disrupted that a series of armored raids—now known as "Thunder Runs"—might completely break their will and ability to resist.

Doctrinally, the first Thunder Run was a raid. There was no expectation to remain inside the city. Rather, this raid would arc through southwest Baghdad to probe the enemy's defenses, inflict casualties, disrupt any attempts to establish a firm defense in the city, and demoralize the Iraqis. The mission for the first Thunder Run on April 5 was given to BCT-2 under the command of Colonel David Perkins. The actual operation was to be conducted by Task Force 1-64 Armor under the command of Lieutenant Colonel Eric Schwartz. Clearly, this was a high-risk operation, but by that point in the campaign the magnitude of U.S. superiority over the enemy was apparent, and the power of armor in urban operations was becoming clear.

Late on the afternoon of April 4, as his task force was completing operations against the remnants of the Medina Division south of Baghdad, Schwartz was told to report to BCT-2's tactical operations center. When he arrived, Colonel Perkins explained

the concept of the Thunder Run and told Schwartz that the operation would start at 6:00 A.M. the next morning. The mission, as well as the concept of a Thunder Run, came as a complete surprise to Schwartz. Realizing that this would be a dangerous assignment, he consulted with the brigade's intelligence staff immediately after receiving his orders from Perkins. Unfortunately, there was almost no intelligence available on what forces the Iraqis had deployed in southwest Baghdad. Such totally inadequate intelligence pictures were the norm for brigade and lower-level ground units throughout the campaign.²⁸ As Schwartz formulated his plans that night, he did so with virtually no information about the extent of any opposition he might meet the next morning.

Realizing that he could meet fierce enemy fire at short range inside the city, Schwartz elected to leave behind all the Task Force's wheeled vehicles—only armored vehicles would go into the city. By this point in the campaign, he had great faith in the protection afforded by the Abrams tank, and he also had confidence that the Bradley fighting vehicles could stand up to most Iraqi fire. Schwartz was far more concerned about his engineer company, which was riding in poorly protected M-113s. Nevertheless, the engineers would join the attack, with the top hatches of their vehicles open so the men could use machine guns, rifles, and grenade launchers. As was always the case in the campaign, Schwartz put tanks at the head of the column; other tanks were spread throughout the line of march, intermingled with the Bradleys and the M-113s. Since Army helicopter operations were prohibited north of the Euphrates, there would be no organic Army aviation support, and no UAVs were available to spot for the advancing armored column. Fixed-wing aircraft were available, however. Schwartz requested that fighters overfly the column, looking out ahead and into side streets that entered his line of march. Since his air liaison officer would be on the Thunder Run, in radio contact with the fighters overhead, Schwartz could benefit from what the fighters managed to spot. Additionally, if rules of engagement allowed, the supporting fighters would be able to attack some targets of opportunity.

At 6:30 A.M. the lead tank started up Highway 8, which leads into southwest Baghdad. The plan was to travel along the highway until it reached the Baghdad airport (Objective LIONS), where BCT-1 was still fighting. The entire route from the line of departure (LD) to BCT-1's positions at the airport was 17 kilometers. With live video images being broadcast from the column, 1-64 Armor entered southwest Baghdad. Colonel Perkins accompanied the task force in his command vehicle, an M-113. In the words of Lieutenant Colonel Schwartz, "When we crossed the LD, we entered the wild, wild west."²⁹

Soon after crossing the LD, intense firing started from both sides of the road. Iraqis fired rifles, machine guns, and RPGs at the vehicles as they moved down High-

²⁸ See Chapter Seven for more details on the inadequacy of intelligence support to combat operations during OIF.

²⁹ Lieutenant Colonel Eric Schwartz, interview with RAND staff, Fort Stewart, Georgia, October 29, 2003.

way 8 at a steady speed of 20 kilometers an hour, with approximately 50 meters between vehicles. The Americans replied with tank main gun rounds and coaxial machine gun fire, the 25mm and coaxial weapons of the Bradleys, .50 caliber machine guns atop the tanks and M-113s, and individual weapons manned by men who fired from open top hatches of the vehicles.

Iraqis fired down on the moving column from overpasses and nearby buildings. RPGs impacted on the sides of the tanks and armored personnel carriers with little effect, until one M-1 suffered a hit (by an RPG or recoilless rifle) on its rear flank that went underneath the skirt armor and penetrated into the engine compartment, starting a fire. Despite attempts to tow the stricken vehicle away, the tank had to be abandoned as the column moved forward. After recovering sensitive items from the vehicle, the crew dropped thermite grenades into the tank and a following vehicle fired 120mm main gun rounds into the tank. Later, the Air Force fired Maverick missiles and JDAMs into the abandoned vehicle to complete its destruction.

It was during the attempt to retrieve the disabled Abrams that the first Iraqi suicide vehicle appeared. From then until the end of the Thunder Run, a number of cars and trucks, presumably loaded with explosives, dashed from side streets and attempted to ram the U.S. vehicles. In most cases the approaching unarmored vehicles were disabled and their drivers killed well before they reached the U.S. column. In a few cases, the vehicles made their way up to the U.S. force, and were then knocked out. The entire time the column was moving, fighter planes provided overhead cover and reported enemy movement in the southwest portion of the city. No artillery was fired in support of this, the first, Thunder Run.

The most intense resistance took place as the column approached the Baghdad airport from the east. A considerable number of Iraqi fighters were in the area around the airport, engaged in action against BCT-1. Those Iraqis were definitely surprised to see a U.S. armored column approaching from their rear. A final Iraqi attempt to halt the column as it approached the airport was made by laying concrete slabs across Highway 8. The lead tank, which had been hit by several RPG rounds during the Thunder Run, crashed the barrier, and 1-64 Armor linked up with elements of BCT-1 shortly thereafter. The entire operation took 2 hours and 20 minutes to traverse the 17-kilometer route. U.S. losses were one tank abandoned, one sergeant (a tank commander) killed in action, and eight personnel wounded. It is estimated that many hundreds of Iraqis died from 1-64's fire. Huge amounts of ammunition were fired during the course of the action: from vehicle main guns, machine guns, and small arms.

Although it was not immediately apparent, 1-64 Armor's Thunder Run broke the back of Iraqi resistance in western Baghdad. Schwartz noted that when he led his battalion back into Baghdad two days later—going much deeper into the city on the second operation—Iraqi resistance was far weaker than during the first Thunder Run. The April 5 Thunder Run clearly showed the value of heavy forces in an urban battle. The success of this operation provided senior commanders with a powerful indicator.

They now saw that the means were at hand to end resistance in Baghdad much earlier than they had originally thought possible.³⁰

While BCT-1 consolidated its position around the airport and BCT-3 expanded its control of the area northwest of the city, BCT-2 used April 6 to prepare for a much larger operation into Baghdad on the following day. The brigade concentrated in the same area from which the first Thunder Run had launched—on the southwest edge of the city. The 3rd ID commander, Major General Blount, directed Colonel Perkins to prepare another Thunder Run into western Baghdad. Into this directive, Perkins read a possibility to employ the entire brigade. Perkins wanted to go deep into Baghdad—all the way to the Tigris River—and possibly remain in the city to help hasten the collapse of the regime. With this more ambitious objective in mind, BCT-2 prepared for the operation.

A number of lessons had been learned from the first Thunder Run on April 5. The Iraqis had used overpasses on highways to fire down on the U.S. column. For the second Thunder Run on April 7, the overpasses over Highway 8 and the Qadisiya Highway that branched off into the heart of the city were targeted with air-burst artillery fire to kill or suppress any defenders. Additionally, the enemy's attempt to use roadblocks on April 5 to halt the column indicated that the Iraqis might try to trap BCT-2 inside the city once it had penetrated deeply into that urban terrain. Therefore, the plan for April 7 included leaving Task Force 3-15 Infantry behind to protect several key road intersections to the rear of the two tank-heavy task forces, 1-64 and 4-64 Armor, that would penetrate into the heart of the city.

The second Thunder Run started at 6:00 A.M. on the morning of April 7. During the night, Iraqi minefields placed across Highway 8 were discovered close to the line of departure. These were removed with no U.S. casualties. The tanks and Bradleys of the two armored task forces in the lead moved with great speed down Highway 8, passing through the road intersections that would then be held by 3-15 Infantry. These intersections were named Objectives CURLY, LARRY, and MOE, from south to north. At Objective MOE, the two tank battalions changed direction, heading eastward at high speed directly toward downtown Baghdad.

At times, Iraqi firing was intense, but, as noted by Lieutenant Colonel Schwartz, enemy resistance was much less than on April 5—at least for the two lead tank units. The heaviest resistance, including some fierce counterattacks, was directed against 3-15 Infantry as it held the “three stooges” objectives along the brigade's line of march (and subsequent line of communications) into the city.

Shortly after the Thunder Run started, disaster struck BCT-2's command element. At 7:00 A.M., as the lead elements of the tank forces were already deep inside the city, a large rocket or missile landed in the middle of the brigade tactical operations

³⁰ Fontenot, Degen, and Tohn, pp. 397–409. Schwartz, October 29, 2003. David Zucchino, *Thunder Run: The Armored Strike to Capture Baghdad*, New York: Atlantic Monthly Press, 2004, pp. 1–66.

center (TOC), which was located at Objective SAINTS. The explosion wrecked many of the unarmored wheeled vehicles that were parked in the area, killed three soldiers and two embedded reporters, and wounded roughly 20 others. The TOC was knocked out of action until the early afternoon, although some control activity was restored within two hours. At the time of the strike, Colonel Perkins was forward in the area of the Thunder Runs. Fortunately, the battalion commanders knew their mission and proceeded forward toward their objective.

Not long after the brigade TOC was hit, a decision was made to let the two leading, tank-heavy teams remain inside the city. These armored task forces were ordered to start consolidating their positions in downtown Baghdad. By mid-morning, they started to occupy government buildings. It was here that the limited numbers of infantry accompanying the tank heavy teams started to be felt; there were too few Bradley-equipped mechanized infantry companies. As the armored units started to consolidate their positions in the city on April 7, even engineers had to perform an infantry function as well as their specialized engineering role. Meanwhile, Major General Blount detached TF 2-7 Infantry from BCT-1 at the airport and moved it to BCT-2's sector to help secure the route leading into the city center. While this was taking place, 3-15 Infantry continued to drive off enemy counterattacks that were launched against the line of communications leading through the "three stooges." All the enemy efforts to dislodge BCT-2 from the city failed, although some U.S. supply columns heading downtown to resupply the armored units were attacked, some vehicles were lost, and some minor casualties were suffered among the troops.

Iraqi counterattacks continued through April 8. The armored task forces deep inside Baghdad fought off groups of enemy infantry and paramilitary fighters. Iraqi troops and Fedayeen attacked over two bridges leading from the eastern portion of the city into the sector held by the Americans. 4-64 Armor employed close air support (CAS) and artillery fire in addition to its organic weapons to defeat enemy efforts to recapture downtown Baghdad. Additionally, 3-15 Infantry fought a series of engagements to defend the brigade line of communications leading into the city.³¹

One of the most intense engagements in the battle for Baghdad took place on April 7–8 in BCT-3's sector north of the city. A major counterattack by Iraqi infantry took place in the vicinity of Objective MONTY starting late on the evening of April 6. The Iraqis shelled the area held by elements of 2-69 Armor, and then they attacked with dismounted infantry, tanks, and BMP fighting vehicles. CAS and field artillery supported U.S. ground troops near the bridge at MONTY. At one point, two gun crews of the 1-10th Field Artillery employed their Paladins in direct fire against approaching Iraqi T-72s. Two Iraqi tanks were destroyed. By the end of the day on April 8, the

³¹ Clearly, the beehive anti-personnel round would have been valuable in fighting off Fedayeen and paramilitary fighters. Although initially fired from artillery weapons, beehive rounds are also available for recoilless anti-tank weapons.

enemy's attempts to retake the bridge at Objective MONTY had ended. Very heavy casualties had been inflicted on the counterattacking Iraqis. The following day, April 9, elements of 1st Marine Division, advancing around the northern portion of Baghdad, linked up with BCT-3, thus completing the total encirclement of the city.

On April 9, elements of BCT-3 attacked southward along Highway 1 to link up with BCT-2 inside the city. By this time, the marines were in control of much of eastern Baghdad, with all three RCTs of 1st Marine Division controlling parts of the city. Organized Iraqi resistance in western Baghdad had largely collapsed by this point, although there were still small groups of enemy fighters who attempted to engage Army forces, usually at considerable cost to the Iraqis. One more major urban fight remained in Baghdad, the attack by 1-5 Marines into the northeastern portion of the city on April 10.

On the same day as the second Thunder Run, RCT-1 and RCT-7 crossed the Diyala River east of the city. Meanwhile, BCT-3 of the 3rd Infantry Division hooked northwest of Baghdad, eliminating Iraqi resistance in that part of the suburbs following heavy fighting on April 6–7. On April 9, 3rd Infantry Division and 1st Marine Division linked in Baghdad and the following day, RCT-5 seized Saddam (later Sadr) City, thereby completing the occupation of Baghdad. The last day of intense fighting inside Baghdad took place on April 10, when a battalion of the 1st Marine Division engaged in an intense 10-hour firefight in the northeastern part of the city. On April 11, the 1st Marine Division formed Task Force Tripoli from its reconnaissance battalions. Three days later, on April 14, Task Force Tripoli occupied Tikrit, the last place in which the regime might have been expected to attempt a stand. Major combat operations were over and the even more dangerous occupation of Iraq had begun. (See Figure 4.13.)

On April 16, General Franks hosted a conference of his component commanders in the Abu Ghraib Palace in Baghdad. Retired General Jay Garner, the head of the Office of Reconstruction and Humanitarian Assistance (ORHA), arrived at Baghdad International Airport on April 21, five days later.

With the seizure of Baghdad on April 5–10 and Tikrit on April 14, the regime of Saddam Hussein and the Ba'athist Party came to an end. Since there was no successor, the occupying powers acquired full authority to govern Iraq in accordance with international law.³² As the regime's power faded, Iraqi citizens began looting government buildings, public facilities, and other buildings, including some factories. In some places, looters stole power lines to recover the copper. Even when coalition forces

³² On May 8, 2003, the Permanent Representatives of the United States and United Kingdom to the United Nations presented a letter to the President of the Security Council stating their objectives and obligations in Iraq. The Security Council noted this letter in Resolution 1483 on May 22, describing the United States and United Kingdom as "occupying powers." The Coalition Provisional Authority (CPA) issued its orders under the laws and usages of warfare and consistent with relevant United Nations Security Council resolutions, including Resolution 1483.

Figure 4.13
Seizure of Baghdad

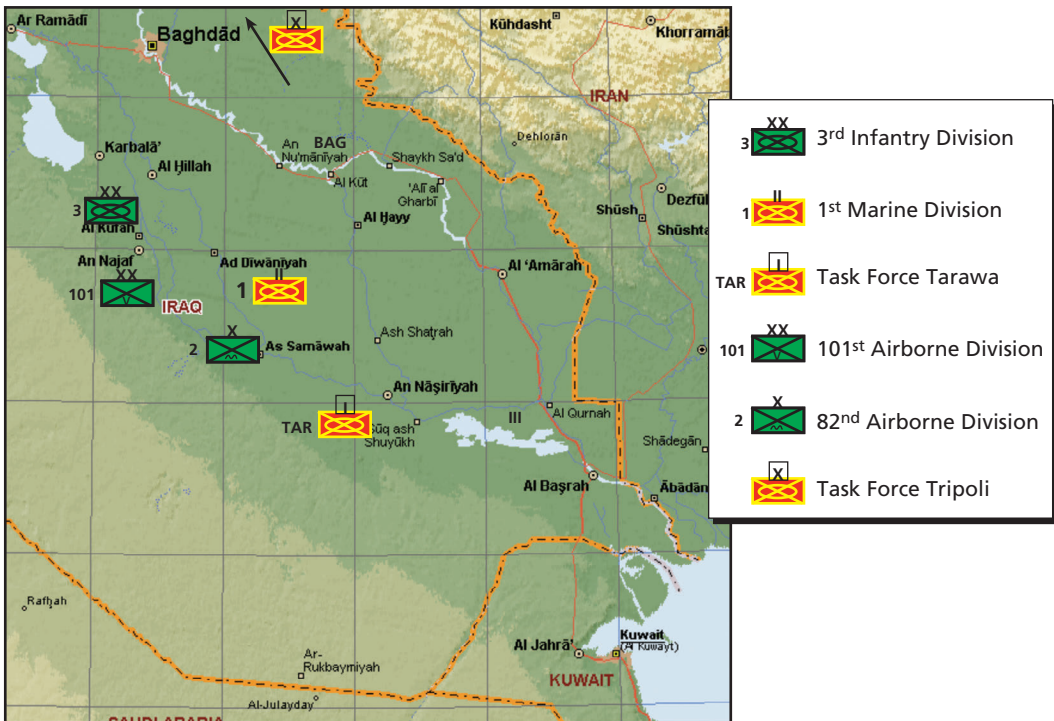

SOURCE: 3rd Infantry Division (Mechanized), *Operation Iraqi Freedom, After Action Report*, Fort Stewart, Georgia, 2003; 1st Marine Division, *After Action Report, 1st Marine Division, Operation Iraqi Freedom*, Camp Pendleton, California, 2003.

RAND MG641-4.13

were on the scene, they were usually powerless to stop the looting. They had no nonlethal means to halt such widespread looting and lethal means were deemed unacceptable. Anticipating an occupation, the coalition had spared Iraq's infrastructure, only to watch helplessly while Iraqis looted their own country.

U.S. forces had too few infantrymen to stop the looting, unless they had opened fire, and even then much looting would have occurred outside their observation. Moreover, firing on civilians would have seemed an inauspicious start to the occupation of Iraq. In a press conference on April 11, Secretary of Defense Rumsfeld said that Iraqis welcomed coalition troops and saw them as liberators, not occupiers. He said that much of the looting was directed against the Ba'ath Party due to decades of repression and claimed that television and newspaper reporting exaggerated the extent of the looting: "I picked up a newspaper today and I couldn't believe it. I read eight headlines that talked about chaos, violence, unrest. And it just was Henny Penny—"The sky is falling!" He also associated looting with freedom:

But in terms of what's going on in that country, it is a fundamental misunderstanding to see those images over, and over, and over again of some boy walking out with a vase and say, "Oh, my goodness, you didn't have a plan." That's nonsense. They know what they're doing, and they're doing a terrific job. And it's untidy and freedom's untidy and free people are free to make mistakes and commit crimes and do bad things. They are also free to live their lives and do wonderful things and that's what's going to happen here.³³

When hostilities ended, coalition forces were not in the locations they would take charge of during the occupation. During the latter part of April, they shifted around the country relieving one another of responsibility. The 1st Marine Expeditionary Force had forces as far north as Tikrit, but its occupation zone was in the south. The newly arrived 4th Infantry Division (Mechanized) relieved Task Force Tripoli in the Tikrit area, while the 3rd Infantry Division relieved the 1st Marine Division in the Baghdad area. In turn, the 1st Marine Expeditionary Force relieved the 82nd Airborne Division in southern Iraq. The 173rd Airborne Brigade secured Kirkuk and linked up with the 4th Infantry Division. The 101st Airborne Division relieved Task Force 20 at the Hadithah Dam and conducted a long-distance air assault to secure Mosul. The 101st Airborne Division then assumed operational control of the 26th Marine Expeditionary Unit and expanded its operations to include all of northern Iraq. The 3rd Armored Cavalry Regiment took responsibility for western Iraq, including the upper reaches of the Euphrates and the entire western desert to the borders with Jordan and Syria. (See Figure 4.14.)

During June, representatives from national contingents began arriving in the Marine Corps' area. On September 3, the commanding general of the 1st Marine Expeditionary Force, Lieutenant General Conway, transferred responsibility to the commanding general of the Polish component.

Special Operations

Special operations forces played an integral part in all aspects of OIF. Within days of the initiation of major combat operations, SOF were conducting operations throughout Iraq. Numerous unclassified reports confirm that by March 19, 2003, SOF were conducting operations in the Kurdish-controlled section of northern Iraq, the western desert between Baghdad and Syria, the eastern border with Iran, and in major cities and towns in the central Tigris-Euphrates Valley. OIF was the largest and most complex operation for Army Special Forces since Vietnam. By the end of March 2003, more than two of the Army's five regular Army Special Forces Groups (SFG(A)) were

³³ U. S. Department of Defense, News Transcript, Secretary of Defense Donald H. Rumsfeld, April 11, 2003.

Figure 4.14
Occupation of Iraq

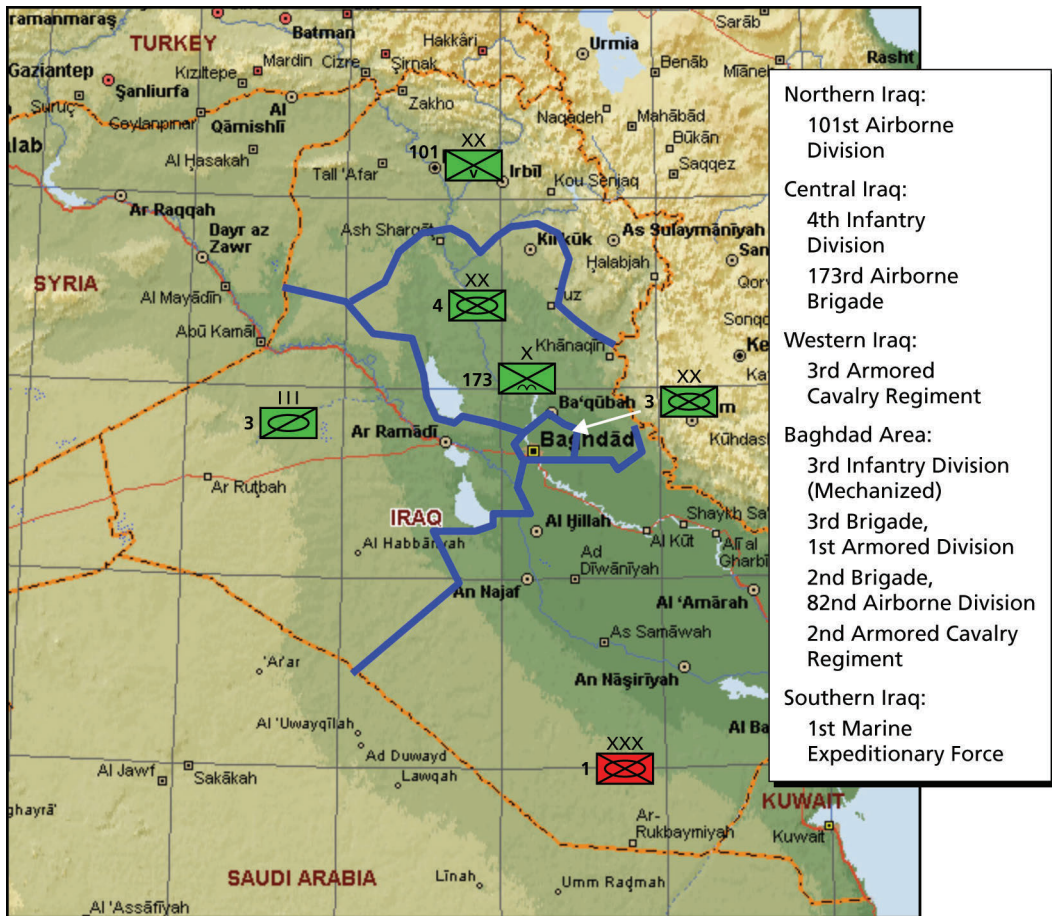

SOURCE: V Corps, "The Road to Victory in Operation Iraqi Freedom," briefing, Heidelberg, Germany, 2003.

RAND MG641-4.14

deployed to Iraq.³⁴ These forces were reinforced by a portion of the 19th SFG(A) from the Army National Guard. In total, more than 50 Operational Detachments Alpha

³⁴ U.S. Army Special Forces are organized into seven Special Forces Groups, five in the Regular Army and two in the Army National Guard, each normally commanded by a colonel. Each group has an assigned area of responsibility to focus its preparation. For example, the 5th Special Forces Group in the Regular Army and the 19th Special Forces Group in the Army National Guard are responsible for the Middle East, Persian Gulf, and Horn of Africa. Each group normally has three battalions, normally commanded by lieutenant colonels, whose headquarters are designated Special Forces Operational Detachment C (SFOD-C). Each battalion normally has three companies, normally commanded by captains, whose headquarters are designated Special Forces Operational Detachment B (SFOD-B). Within each company are squad-sized teams designated Special Forces Operational Detachment A (SFOD-A or simply ODA). Each ODA consists of 12 soldiers as follows: commander (captain), executive officer (warrant officer), and two soldiers in each of these specialties: operations, weapons, engineer,

(ODAs) were deployed in northern Iraq, while a similar number operated in the western desert. In addition to Army Special Forces units, a significant portion of the Army Ranger Regiment and other elements of the Joint Special Operations Command, Naval Special Warfare Group One, and the U.S. military's special operations aviation fleet were assigned missions inside Iraq.

The Special Operations Command subordinate to U.S. Central Command (SOCCENT) organized four subordinate commands: Joint Special Operations Task Force–West (JSOTF-W), Joint Special Operations Task Force–North (JSOTF-N), Naval Special Warfare Task Group Central (TG-Cent), and Task Force 20. JSOTF-N included the 173rd Airborne Brigade and 10th Special Forces Group (SFG). (See Figure 4.15.)

This sizable U.S. contingent was augmented by a large number of British, Australian, and Polish special operations forces. Together, these forces performed the following key roles: preventing the Iraqi V Corps from moving south to reinforce Baghdad; conducting special reconnaissance and direct action in the western desert; locating and destroying Iraqi ballistic missile capabilities; supporting conventional forces in their movement north toward Baghdad; interdicting Iraqi lines of communication, especially on the East-West highway between Syria and Baghdad; seizing and protecting oil fields and pumping stations throughout Iraq; seizing critical airfields; and capturing most of the high-value targets contained in CENTCOM's "deck of cards."³⁵

On March 21, 2002, General Franks issued guidance for the conduct of special operations in a meeting of his component commanders at CENTCOM headquarters. During this meeting, General Franks told his component commanders to instill a sense of urgency in their staffs and not to promise anything they could not deliver. Participants at this meeting included the commander of Special Operations Command Central (SOCCENT), Brigadier General (USA) Gary L. Harrell, and the commander of Task Force 20, Major General (USA) Del Dailey.³⁶

medical, and communications. The operations element normally consists of a master sergeant and a sergeant first class. The other elements normally consist of a sergeant first class and a staff sergeant.

³⁵ From Linda D. Kozaryn, "Deadly Cards Help Troops Identify Regime's Most Wanted," *Armed Forces Press Service*, April 12, 2003:

Coalition officials identified a list of 55 key regime leaders they intend to pursue, kill or capture, Army Brigadier General Vincent Brooks, deputy director of operations at U.S. Central Command, said in Qatar April 11 [2003]. "The list does not exclude leaders who may have already been killed or captured." Command officials designed the cards displaying the names, faces, and titles of the Iraqis to help soldiers and marines in the field should contact occur. Each deck has two Jokers, one showing Iraqi military ranks and the other, Arab tribal titles. Saddam Hussein is depicted on the Ace of Spades. The list [was] also distributed throughout Iraq in other forms, such as posters and handbills, which [were] more visible.

³⁶ Woodward, pp. 113–114.

Figure 4.15
Organization of Special Operations Forces in Operation IRAQI FREEDOM

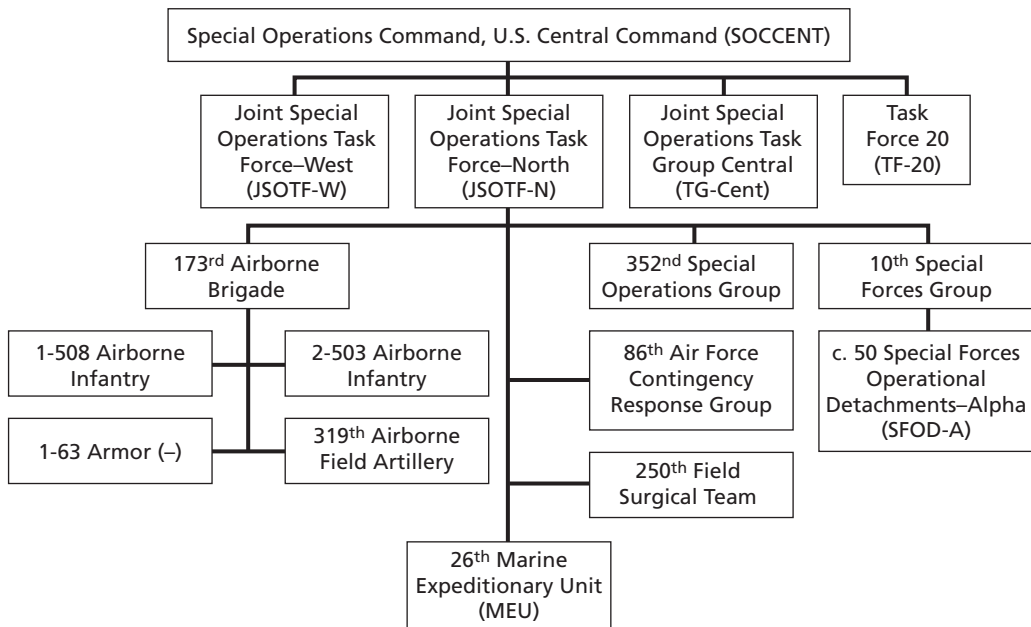

RAND MG641-4.15

Creation of a Joint Special Operations Task Force

The 5th and the 10th Special Forces Groups had to convert a group headquarters consisting of 90 to 100 personnel into a Joint Special Operations Task Force (JSOTF) headquarters consisting of more than 200 personnel. Just as an Army divisional headquarters requires augmentation to become the headquarters of a joint task force, a Special Forces Group requires augmentation to become the headquarters of a JSOTF. The transition requires not only more personnel but also additional equipment.

Colonel (USA) Charles Cleveland, commander of the 10th SFG, and his Air Force counterpart, Colonel O. G. Mannon, the commander of the 352nd Special Operations Group, pursued an innovative approach to establishing a JSOTF headquarters. In August 2002, Colonel Cleveland and Colonel Mannon met while they were participants at Millennium Challenge 2002 sponsored by U.S. Joint Forces Command. During this exercise, they discussed how the 352nd Special Operations Group would provide aviation support to the JSOTF. During the conversation, Colonel Mannon suggested that the Army's 10th Special Forces Group and the Air Force's 352nd Special Operations Group merge their headquarters to forge a joint special operations headquarters, capitalizing on the unique strengths of both organizations. Colonel Mannon offered to serve as the deputy commander of this JSOTF. Although some in the Air Force chain of command opposed this concept because of the precedent it

could establish, it was eventually approved in October 2002. Working together, these two commanders and their combined staffs prepared and executed the operational plan for Joint Special Operations Task Force–North (JSOTF-N). This combined staff remained until the JSOTF was disbanded in July 2003.³⁷

Joint Special Operations Task Force–North

The 10th Special Forces Group was ordered to establish JSOTF-N. Once operational, JSOTF-N was directed to work with Kurdish forces in northern Iraq, secure the Kirkuk oil fields and petrochemical infrastructure, establish a buffer between the Turkish military and Kurdish forces, and provide assistance to the commander of the 4th Infantry Division in his effort to fix and destroy the Iraqi V Corps. By December 2002, however, concerns began to mount that the Turkish government would not allow the movement of the 4th Infantry Division (Mechanized) through Turkish territory.

When the Turks closed the northern front to the 4th Infantry Division in the end, JSOTF-N received orders to fix the Iraqi V Corps in place and prevent large-scale movement of Iraqi forces south to reinforce defenses around Baghdad. JSOTF-N had complete responsibility for combat operations in northern Iraq until such time as ground forces assigned to the CFLCC could fight their way north from Kuwait.³⁸

The JSOTF-N commander faced great challenges. First, he would have to increase the combat power of the Kurds so they could attack Iraqi military forces successfully along the line of confrontation, while simultaneously restraining the Kurds to ensure that Turkey did not feel compelled to intervene in northern Iraq. Second, he would have to infiltrate Special Forces teams into the country. Prior to D-day, it was especially critical to infiltrate a sufficient number of teams into northern Iraq to make contact with other government agencies already operating there and prepare the SOF teams to begin operating upon commencement of hostilities. Finally, he had to synchronize the actions of assigned and attached forces.

U.S. Relations with the Kurdish Opposition. Over 30 million Kurds live in their ancient homeland, which is spread across parts of Iran, Iraq, Syria, and Turkey. Most of the Kurdish homeland falls within the borders of northern Iraq and southeastern Turkey, but a significant number of Kurds remain in eastern Syria and northwestern Iran. (See Figure 4.16.)

The United States supported the Kurdish people in the aftermath of Operation DESERT STORM. Prompted by U.S. radio and television broadcasts that urged them to revolt in 1991, the Kurds of northern Iraq defeated a disorganized Iraqi army and seized several Iraqi towns. But within days, the Iraqi military recovered from this initial

³⁷ Colonel Charles Cleveland, commander JSOTF-N, interview with RAND staff, Fort Bragg, North Carolina, February 20, 2004.

³⁸ Cleveland interview.

Figure 4.16
Kurdish Inhabited Area

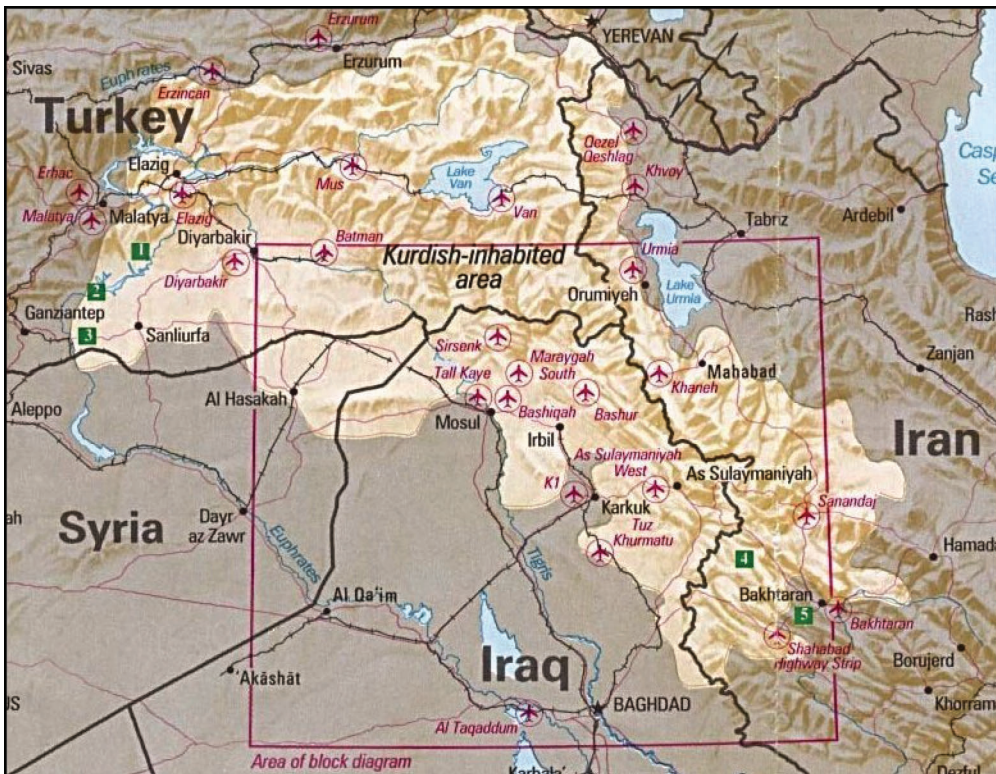

RAND MG641-4.16

defeat and launched a ruthless counteroffensive, which included napalm and chemical weapons delivered by helicopters.

In an effort to escape the carnage, nearly 3 million Kurdish refugees began to flee toward the mountains of Turkey and Iran. Without food, water, or shelter, conditions in the refugee camps established for them deteriorated rapidly. On April 5, 1991, the UN Security Council approved Resolution 688, which condemned Iraqi repression and asked member states to assist the Kurds and other refugees in northern Iraq. The following day, Joint Task Force Provide Comfort deployed to Incirlik Air Base in Turkey to conduct humanitarian operations. When it became clear that a ground presence would be required, Joint Task Force Alpha (JTF-A) was established in the mountains of south-east Turkey, headquartered in Silopi, and charged with alleviating suffering and dying among the refugees and stabilizing the situation. JTF-A consisted largely of U.S. soldiers from the 10th SFG; it was commanded by Brigadier General (USA) Richard Potter.

The second component of Operation PROVIDE COMFORT was Joint Task Force Bravo, comprised mainly of elements from the 24th Marine Expeditionary Unit and commanded by Major General (USA) Jay Garner. Its mission was to prepare the

town of Zakho for the incoming flow of Kurdish refugees and to facilitate their eventual transfer back to their homes. Together these two units on the ground built refugee camps and maintained a security zone in northern Iraq that served to protect the Kurds from further Iraqi aggression. In addition, Air Force elements operating out of Incirlik established no-fly zones for Iraqi air forces above the 36th parallel, while providing air cover for friendly forces on the ground, and delivered large quantities of humanitarian supplies. By mid-July 1991, the task force removed its ground forces from Iraq but left a residual force in southeastern Turkey.

Soon after Operation DESERT STORM, the United States established official contact with the Kurdish Democratic Party (KDP) and its largest splinter group, the Patriotic Union of Kurdistan (PUK) in the Kurdish Autonomous Zone (KAZ). While these were the two largest groups, the Kurdistan Freedom and Democracy Congress (KADEK) was the most militant of the other Kurdish groups, blending a Marxist-Leninist ideology with pan-Kurdish nationalism. In March 2003, KADEK claimed to have more than 10,000 fighters deployed in the Qandil mountains, which straddle portions of Iraq, Turkey, and Iran (Figure 4.17). The government of Turkey considered KADEK a terrorist organization and repeatedly conducted military operations inside Iraq to attack its base camps.

A line of confrontation separated the KAZ from the parts of Iraq under the direct control of the Iraqi government. Up to 13 Iraqi divisions defended south of the line, and about 69,000 Kurdish militia defended the KAZ. Although KADEK was considerably smaller than either the PUK or the KDP, it wielded significant power in its mountain stronghold.

In 1991, the CIA began an operation designed to provide the Kurds with a military capability for protecting themselves from Saddam Hussein.³⁹ While the United States sought to maintain the territorial integrity of Iraq, most members of the KDP and the PUK sought independence and creation of a Kurdish state. This conflict in goals manifested itself in 1995 when the CIA learned that the Kurds were planning an insurrection throughout northern Iraq. The United States warned the Kurd leaders that if they were to pursue this course of action they would forfeit all U.S. support. Following this ultimatum, which the Kurds ultimately accepted, the CIA continued its support of the Kurdish opposition to Saddam Hussein's regime.

When the 10th SFG was directed to establish JSOTF-N to work with the Kurdish resistance, most members of the unit believed they were well prepared for the mission. The 10th SFG had established ties to the Kurds during its involvement in PROVIDE COMFORT. Some members of the 10th SFG had worked in northern Iraq since 1994. For many of these soldiers, this assignment would allow them to build upon relationships that had been formed years earlier.⁴⁰

³⁹ Darlene Casella, "A Nation without a Country—Kurdistan," *Family Security Matters*, June 17, 2014.

⁴⁰ Cleveland interview.

Figure 4.17
Political Boundaries of Northern Iraq

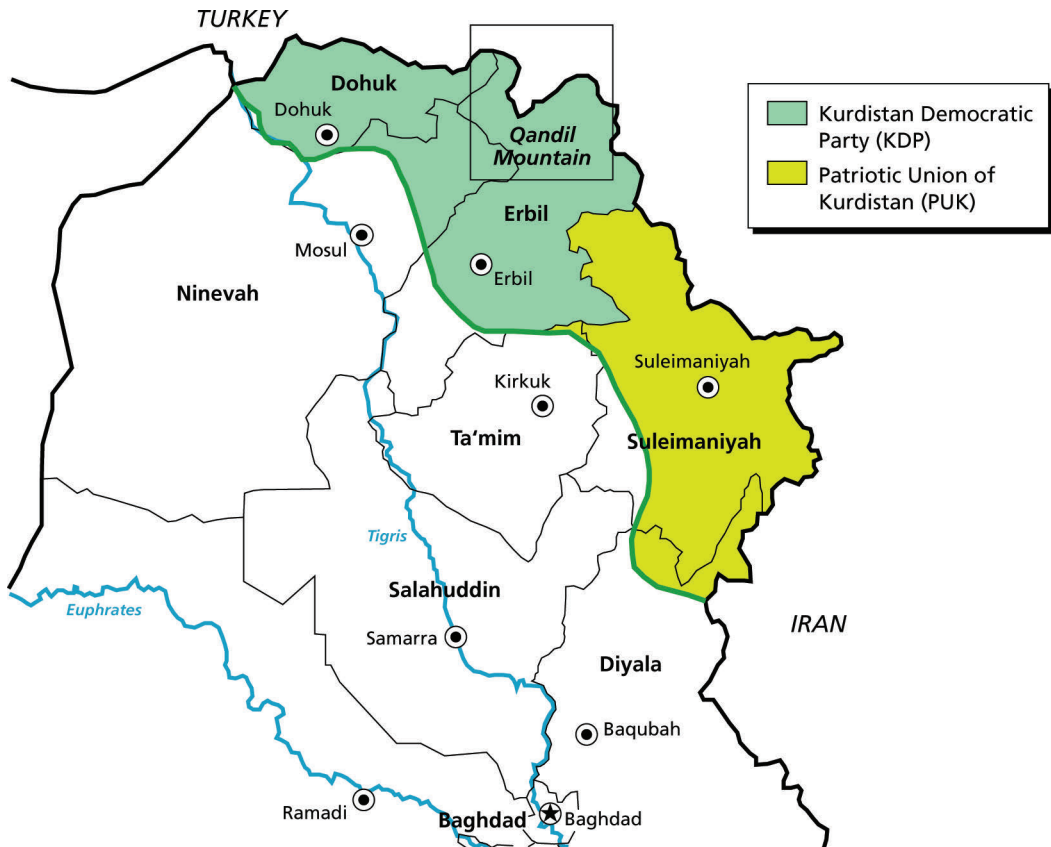

RAND MG641-4.17

All that was necessary to initiate combat operations was the arrival of the main body of JSOTF-N. Unfortunately, the Turkish parliament had voted not to allow the United States to use its airspace to launch an attack. That changed on March 20 when the parliament voted 332-202 in favor of allowing its airspace to be used by coalition aircraft conducting military operations against Iraq. With this news, JSOTF-N contacted U.S. European Command (EUCOM) to get the requisite authorization to conduct the air movement from Romania to Iraq by flying through Turkish airspace. Unfortunately, EUCOM responded by stating that while parliament had voted to allow the use of its airspace, the Turkish military would not “authorize” such overflight unless the United States agreed to allow it to move some of its forces into the KAZ. The answer to the Turkish military demand by Colonel Cleveland was “Absolutely not.”⁴¹

⁴¹ Cleveland interview.

A key assumption in the planning conducted by JSOTF-N had been that Turkish airspace would be available for use; however, in the weeks preceding D-day the planning staff within JSOTF-N had begun to develop two plans for the infiltration of the main body of JSOTF-N into Iraq. The first (and the preferred) option was to deploy forces directly from Constanta, Romania, to northern Iraq using air routes over Turkey. The second, more complex and dangerous option would deploy forces to northern Iraq via a circuitous route that started at Constanta and then flew over heavily protected airspace that pilots called “SAM Alley.” As this option was being briefed to Colonel Cleveland, one member of his staff responded by saying “that’s one ugly baby.” The name stuck. From that point onward, this route was referred to as “the Ugly Baby.”⁴²

At 7:30 P.M. on March 20, 2003, six MC-130 “Combat Talon” transport aircraft from the 352nd Special Operations Air Group departed from Constanta, Romania, and flew via the Ugly Baby route into northern Iraq. The plan called for three of the aircraft to take elements of 2-10 SFG to a landing strip at Bashir, the location that would later be used by the 173rd Infantry Brigade (Airborne) to conduct a combat jump. The remaining three aircraft were to continue eastward and land at As Sulaymaniyah in the heart of PUK-controlled territory and only 25 miles from the town of Sargat, the base camp of the terrorist organization Ansar al-Islam.⁴³

As the aircraft approached Iraqi airspace the pilots dropped to an altitude of 50 to 100 feet, at which altitude they would fly “nap of the earth” above the desert floor for the last three hours of the flight. Although the first Iraqi defenders in SAM (Surface-to-Air Missiles) Alley were taken by surprise as the lead aircraft passed overhead, the second plane caught their attention but, fortunately, their AAA fire flew well over the aircraft. By the time the third and trailing MC-130s flew by, however, the Iraqi air defense units had zeroed in and were placing effective fire on the low-flying aircraft. In fact, the fifth aircraft was hit by 28 rounds of anti-aircraft ammunition and was forced to head into Turkey and make an emergency landing at Incirlik Air Base. When the Turkish General Staff heard that an MC-130 had almost been shot down as a result of their decision not to authorize an overflight that had been approved by their parliament, the decision was immediately reversed. Starting on March 21, 2003, Turkish airspace was used to transport JSOTF-N units from Romania into the KAZ.⁴⁴

Operation VIKING HAMMER. Shortly after the initiation of OIF, SOF conducted a large assault in the northeastern portion of Iraq near the Iranian border, about 25 miles east of As Sulaymaniyah. The ensuing battle lasted over two days and ended with the seizure of the base camp that had been used by the terrorist organization noted above, Ansar al-Islam.

⁴² Cleveland interview.

⁴³ Cleveland interview.

⁴⁴ Cleveland interview.

Many Kurds who had survived Saddam Hussein's use of chemical weapons in the town of Halabja and the surrounding region in 1988 had fled to Iran. With the creation of the no-fly zone in 1991, many of these refugees returned to their homes in As Sulaymaniyah. Some members of this group had become radical Islamists during their stay in Iran, and they soon began to challenge the authority of the PUK and KDP. They also established their own guerrilla network in opposition to Saddam Hussein.⁴⁵

The largest of these groups, the Islamic Movement of Kurdistan, began to form in 1991 with the help of Iranian officials. In June 2001, disputes over Islamic doctrine caused this group to splinter. Hardliners who admired Osama Bin Laden or had direct experience working with al Qaeda formed Jund al-Islam ("Soldiers of Islam"). This group, made up of Iraqi Kurds and foreign Arabs, soon joined forces with other like-minded militants under the control of Mullah Krekar and formed Ansar Al-Islam on September 1, 2001. Prior to the initiation of hostilities in OIF, Ansar controlled a small area of about 100 square kilometers centered on the village of Biyarah about 20 kilometers northeast of Halabja near the Iranian border.⁴⁶ While the primary headquarters of Ansar was established in the town of Khurmali, it also conducted training and recruitment activities in the mountain villages of Gulp and Dekon. However, the largest stronghold of Ansar was in the village of Sargat, located approximately 6 kilometers east of Khurmali and 5 kilometers north of Gulp. The United States suspected that Ansar was experimenting with chemical and biological agents in this village.⁴⁷

Ansar al-Islam originally had two goals, one international and the other local. First, the Ansar leadership wanted to create a Taliban-style Islamic emirate that would be integrated into an Islamic world of emirates.⁴⁸ Second, it wanted to provide a safe haven for Islamic militants. In the pursuit of these goals, Ansar waged a fratricidal jihad against secular Kurdish opponents while developing capabilities that could be used to conduct terrorist attacks throughout the region. By the beginning of OIF, the PUK and KDP viewed Ansar as a dangerous enemy. During the summer of 2002, the PUK made preparations for an offensive against Ansar and built fortifications in the valley that surrounds the mountains that Ansar controlled, while increasing the strength of its forces to over 3,000 armed fighters.⁴⁹ From these fortifications, peshmerga and U.S. forces would launch attacks in the following year.

Kurdish military commanders believed that Ansar had about 900 combatants, many of whom had been involved in combat operations in Afghanistan and taken refuge with Ansar after the collapse of the Taliban. Another radical Islamic organiza-

⁴⁵ "Al-Qaeda in Northern Iraq? The Elusive Ansar al-Islam," *IJSS Strategic Comments*, Vol. 8, Issue 7, September 2002.

⁴⁶ "Al-Qaeda in Northern Iraq? The Elusive Ansar al-Islam," p. 1.

⁴⁷ Cleveland interview.

⁴⁸ "Al-Qaeda in Northern Iraq? The Elusive Ansar al-Islam," p. 2.

⁴⁹ "Al-Qaeda in Northern Iraq? The Elusive Ansar al-Islam," p. 2.

tion known as the Komali-Islami Kurdistan (Islamic Party of Kurdistan) and consisting of 1,500 fighters had formed an alliance with Ansar and was co-located with it near the Iraq-Iran border town of Biyarah. According to prewar estimates, as many as 3,000 terrorists were operating out of this area.⁵⁰

On March 22, 2003, using several dozen Tomahawk missiles and other precision munitions, the United States launched an air attack against the terrorist group's base camp near Khurmal. These attacks forced members of Ansar al-Islam to flee down the mountain and take up defensive positions near the villages of Dekon, Gulp, and Sargat. On March 26, 2003, U.S. SOF and Kurdish fighters began massing forces in preparation for Operation VIKING HAMMER, a ground assault on Ansar al-Islam. The final phase of the operation began on March 28, when Operational Detachment Bravo (ODB) 090, including ODA 091, ODA 093, ODA 094, and ODA 095, augmented by approximately 10,000 peshmerga initiated a three-pronged attack to destroy the terrorist organization and seize the base camp at Sargat.⁵¹ In addition to these infantry forces, Colonel Cleveland had attached ODB 390 from 3-3 SFG(A) to provide additional firepower with their heavily armed HMMWVs.⁵²

The concept of operations entailed establishing a zone of operations approximately 20 kilometers in diameter that included all the towns and villages controlled by Ansar. Special Forces, augmented by peshmerga, established blocking positions on the outer perimeter within Iraq in an attempt to prevent the terrorists from escaping during the attack. The southern "blue" route objectives were to seize the villages of Tawera, Palaniyan, and Tawela, then attack the village of Biyara on the Iranian border. The northern "green" route was used to seize the stronghold village of Khurmal as well as Klay Bakh and Zalm. Finally, the center "yellow" route mission was to seize and destroy the terrorist base camp at Sargat.

The assault began at 6:00 A.M. on March 28 when ODA 092 and ODA 093 started advancing along the "yellow" route with over 1,000 peshmerga. Meanwhile, ODA 095 began moving with another contingent of peshmerga along the route blue, approximately two kilometers south of the central yellow route, and ODA 094 began its movement north toward Khurmal via the green route.

Following these advancing units came a second group of U.S. forces consisting of elements from ODB 390 mounted in their HMMWVs armed with .50 caliber machine guns and MK-19 grenade launchers. Alongside this U.S. force was a large group of peshmerga armed with Soviet-made ZSU 23mm anti-aircraft machine guns and heavy mortars mounted on wheeled vehicles. This heavily armed vehicular force

⁵⁰ Major Mark Mitchell, J-3, Future Operations, Special Operations Command Central, interview with RAND staff, Tampa, Florida, August 7, 2003.

⁵¹ Linda Robinson, *Masters of Chaos: The Secret History of Special Forces*, New York: Public Affairs, 2004, pp. 305–323.

⁵² Cleveland interview.

under the control of U.S. SOF would provide supporting fire for the advancing ODAs and their associated peshmerga.⁵³ A third group, which followed the assault elements and the support elements, comprised personnel from the 900th Chemical Reconnaissance Detachment and other specialized units configured for sensitive site exploitation after the Ansar al-Islam base camp had been captured.⁵⁴

As friendly forces moved close to the mountain hideout, Ansar guerillas began to take them under machine gun fire. The closer they came to the mountain, the more intense the incoming fire became. Soon, Katusha rockets, ZSU 23mm weapons, and AK-47s augmented the machine gun fire. Under intense fire, the ODAs fought side by side with their peshmerga counterparts as they moved slowly up the mountain. Once within range, the support element opened fire with its .50 caliber machine guns, peshmerga Katusha rockets, mortars, and ZSU 23mm anti-aircraft guns. Perhaps the most devastating weapon was the MK-19 grenade launcher, which was able to place effective fire in the dead space that the other weapons could not reach, striking places where the guerillas felt secure.⁵⁵

It took about 30 minutes for coalition forces to seize the first ridgeline and continue their movement toward the village of Dekon, which served as one of the headquarters for Ansar. Once Dekon was seized, the coalition continued to move up the mountain toward the village of Gulp. Because the only approaches to Gulp were narrow trails on the sides of steep mountains, Ansar guerrillas were able to delay the advance of coalition forces by firing at the forward elements. By 7:15 A.M., the attack had stalled because of the intensity of fires coming from Gulp. Fortunately, a tactical air control party (TACP) assigned to work with ODB 090 contacted a Navy F/A-18 aircraft that accurately placed two 500-pound bombs on the hilltop emplacements of Ansar. The TACP then talked the pilot through a strafing run parallel to the forward line of friendly troops along the ridgeline where the Ansar guerrillas had been fighting. By 8:00 A.M., friendly forces had seized the high ground northeast of Gulp and the peshmerga swept through and secured the village. When a number of Ansar guerillas pretended to surrender, members of ODB 090 used interpreters to make them disarm and disrobe at a distance. This was a fortunate decision because a number of the captured terrorists were wearing suicide vests and, when directed to disrobe, used the weapon to commit suicide. No friendly soldier was injured as a result of this tactic. The Ansar guerillas who had not been killed or captured retreated northeast toward the Iranian border and their base camp at Sargat.⁵⁶

⁵³ Robin Moore, *Hunting Down Saddam: The Inside Story of the Search and Capture*, New York: St. Martin's Press, 2004, p. 31.

⁵⁴ Cleveland interview.

⁵⁵ Moore, *Hunting Down Saddam*, p. 32.

⁵⁶ Moore, *Hunting Down Saddam*, p. 34.

The village of Sargat was situated in a small bowl-shaped valley that was bounded on three sides by very high and steep mountains that provided excellent defensive positions. This was the mountain stronghold of Ansar al-Islam, what one soldier called their “Alamo.” The ground movement toward this village proved to be the most dangerous and arduous portion of the attack thus far. The mountain was so steep that the trail zigzagged, creating a switchback. As the friendly forces moved up the trail, Ansar guerrillas prepared to place direct and indirect fire at the center of the switchback. The volume and accuracy of this enemy firepower at the switchback forced the attacking coalition forces to halt their movement until they could dismount several MK-19s and bring them forward where they would be in range of the enemy forces. Using a combination of direct fire from their individual weapons and M-240B SAW light machine guns, augmented by the fires from the MK-19 grenade launchers, the ODAs were able to suppress the enemy fire long enough to allow peshmerga fighters to successfully launch a flanking attack, forcing the Ansar guerrillas to retreat into Sargat. From the center of the switchback, the coalition forces were able to look directly into the heart of Sargat where the remaining elements of Ansar were setting up a final defense.⁵⁷

Once the peshmerga fighters had secured the approaches to the switchback, elements of ODB 390 drove their vehicles up the trail and dismounted additional MK-19 grenade launchers and M2HB .50 caliber machine guns to establish an overwatch position for the final attack. While the support force was setting up its firing positions, the assault force began to climb up the final slope and move into its attack positions. Throughout this movement, coalition forces remained under heavy fire from enemy forces located in Sargat. The coalition attack began with the initiation of suppressive fires from ODB 390. This intense suppressive fire allowed the peshmerga and the ODAs to make the final assault into Sargat.⁵⁸ As the ODAs swept through the village, they discovered that most of the guerrillas either had been killed or had escaped into Iran. They left behind much information.⁵⁹ Operation VIKING HAMMER lasted just a little more than 48 hours, yet it was one of the largest battles ever conducted by SOF. Two ODBs worked closely with approximately 10,000 peshmerga fighters to destroy the largest terrorist organization in existence in Iraq at that time. Not a single U.S. soldier was either killed or wounded in the battle. Twenty-four peshmerga were killed and approximately 80 wounded in action.⁶⁰

In the aftermath of the assault on Sargat, Special Forces units discovered manuals relating to the production and use of sarin gas, cyanide, and ricin. In addition, chemical protective masks, atropine injectors, and al Qaeda training manuals were also

⁵⁷ Moore, *Hunting Down Saddam*, p. 35.

⁵⁸ Moore, *Hunting Down Saddam*, pp. 35–37.

⁵⁹ Cleveland interview.

⁶⁰ Cleveland interview.

found at the site.⁶¹ Finally, a cache of documents was captured along with computer disks and foreign passports belonging to Arab terrorists from around the Middle East. These documents linked Ansar activities to those being conducted by HAMAS, Abu-Sayaff in the Philippines, and al Qaeda.

As important as this information was, perhaps the most important aspect of this victory was the trust that developed between the peshmerga and JSOTF-N. The peshmerga now knew from first-hand experience how a small number of SOF could generate very great combat power when supported by air power and other indirect fires. The indirect fire capability of the MK-19 grenade launcher, for example, provided advancing ground forces with an ability to suppress enemy fire in mountainous areas unlike any other tactical weapon on the battlefield. Soldiers and airmen from JSOTF-N not only moved with the forward elements of the peshmerga, but they also coordinated air support efforts during the assault. The ability of SOF to control air strikes especially impressed the peshmerga leadership. The mutual trust established during this operation set the stage for other operations in northern Iraq as coalition forces sought to destroy Iraqi forces along the line of confrontation, liberate the cities of Mosul and Kirkuk, and safeguard the oil pipelines and transfer points linking Turkey to Iraq and providing fuel to central and southern Iraq.⁶²

Advance to Mosul. The infiltration of JSOTF-N into Iraq began on March 21, but lack of strategic lift delayed the start of operations to rout the Iraqi forces and to seize the city of Mosul. The mission of seizing Mosul was assigned to 2-10 SFG, augmented by ODB 370. While elements of 2-10 SFG were infiltrating from Constanta into the KAZ during the last week of March, the peshmerga under the control of General Mustafa began to mass for an attack. On April 3, sufficient forces were in place to initiate offensive operations.⁶³

As 2-10 SFG and the peshmerga militia began the advance toward Mosul, they ran into an Iraqi armor task force that was defending the bridge at Aski Kalak from fortified positions. The Iraqi unit defending the bridge laid a heavy volume of fire on the advancing SOF and Kurdish fighters, forcing them to withdraw. Although ODA 065 led the attack, on three separate occasions a quick-reaction force consisting of ODA 043, ODA 045, and a contingent of Kurdish fighters had to be employed to prevent ODA 065 from being overrun. On April 5, a concerted attack on the bridge was initiated and, after six failures, it was finally secured. The Iraqi task force defending the bridge launched a number of counterattacks on April 5 until all of its armored vehicles were destroyed by coalition air support and SOF personnel using Viper and Javelin anti-tank weapon systems. With the bridge taken, 2nd Battalion, 10 SFG 102

⁶¹ "Chemical Clues Found in Northern Iraq," ABC News, April 1, 2003.

⁶² Cleveland interview.

⁶³ Moore, *Hunting Down Saddam*, p. 43.

set out to seize the heavily defended town of Debecka, considered to be the gateway to Mosul from the KAZ.⁶⁴

The last coordinated Iraqi military opposition to the U.S.-led Kurdish advance occurred along the Debecka ridge on April 6. Elements of ODA 044, ODA 391, and ODA 392 from Forward Operating Base (FOB) 102 were tasked with securing Objective ROCK, a key intersection near the town of Debecka between the cities of Irbil and Mosul.⁶⁵ Objective ROCK sat astride a ridgeline where the Iraqis had constructed a system of shallow trenches for Iraqi armored battalions.⁶⁶ At 4:00 A.M., B-52 bombers attacked these Iraqi positions preparatory to an assault on the Debecka ridge. Two hours later, ODAs joined with approximately 80 peshmerga fighters and began advancing toward the ridge. At 7:00 A.M., coalition forces reached the base of the ridge and traversed a minefield where peshmerga engineers had cleared a lane. While vehicles from ODA 391 and ODA 392 were advancing, they had to breach a large dirt berm lying across the roadway. At this obstacle, Iraqi forces occupying the ridgeline engaged the allied force with small arms and 106mm recoilless rifle fire. Because of the volume of Iraqi fire, the attempt to breach the obstacle was aborted and a decision made to assault the ridgeline with dismounted SOF and peshmerga. By 8:15 A.M., FOB 102 seized Objective ROCK and captured approximately 20 Iraqi soldiers.⁶⁷

During an initial interrogation, a captured Iraqi major related that an Iraqi armor unit had withdrawn to the south and abandoned his unit after the B-52 bombing. Approximately 30 minutes later at 8:45 A.M., an SOF soldier operating a Pointer UAV reported that an Iraqi armor unit was moving north to counterattack. The attacking force consisted of one tank platoon, two mechanized infantry platoons, and additional infantry loaded in trucks. Iraqi artillery, mortars, and at least one ZSU 57-2 self-propelled anti-aircraft gun were being used in support of the Iraqi attack.⁶⁸ Approximately 900 meters from Objective ROCK, SOF engaged an Iraqi light vehicle with a .50 caliber machine gun, causing it to run off the road. This vehicle was followed by a truck carrying infantry that was destroyed by a SOF sergeant using a Javelin missile at a range of approximately 3,000 meters. During the next half hour, other light-skinned vehicles carrying Iraqi troops were engaged with limited success.⁶⁹

At 11:40 A.M. a U.S. soldier reported that Iraqi T-55 tanks and armored personnel carriers were moving toward Objective ROCK with tanks in the lead, and other tracked vehicles were being arrayed in combat formations in the open fields on either

⁶⁴ Moore, *Hunting Down Saddam*, p. 43.

⁶⁵ Fontenot, Degen, and Tohn, p. 308.

⁶⁶ Moore, *Hunting Down Saddam*, p. 44.

⁶⁷ "U.S. Increases Order for Combat-Tested Javelin," Raytheon, News Release, October 5, 2005.

⁶⁸ Fontenot, Degen, and Tohn, p. 308.

⁶⁹ "U.S. Increases Order for Combat-Tested Javelin," pp. 2–3.

side of the road. As the T-55 tanks opened fire with their 100mm main guns, a number of SOF dismounted and began to engage the advancing enemy with Javelin missiles. The remaining members of ODA 391 and ODA 392 made effective use of their .50 caliber machine guns, MK-19 grenade launchers, and 60mm mortars to disrupt the attack, prevent the advance of dismounted infantry, and force the Iraqis to drive with the hatches closed. At 11:54 A.M. a SOF TACP assigned to FOB 102 directed two U.S. Navy F-14 Tomcats to use Paveway II bombs on the advancing armored column.⁷⁰

The battle at Debecka ridge lasted until approximately 12:30 P.M., when the surviving Iraqi soldiers fled the battlefield on foot. SOF supported by CAS had defeated the armored counterattack with no U.S. casualties. In the final moments of the battle, however, a member of the SOF TACP contingent requested air support to destroy an Iraqi tank firing from the south. Unfortunately, one of the bombs dropped by a Navy F-14 missed its mark and landed on a group of peshmerga fighters who were regrouping on the ridgeline, killing 17 and wounding an additional 45.⁷¹

With the seizure of Debecka gap and the nearly simultaneous raid on the town of Ayn Sifni on April 6, the Iraqi defenses crumbled. The totality of the collapse took JSOTF-N by surprise as success generated a momentum of its own. On April 8 the peshmerga and FOB 102 gained control of the towns of Mahkmur, Altun Kupri, and Dibs. On April 9, as many as nine other cities and towns were “liberated” by peshmerga and SOF forces.⁷²

On April 10, Lieutenant Colonel Robert Waltemeyer, the commander of 2-10 SFG, accepted a ceasefire agreement signed by the commander of the Iraqi V Corps. As soon as the agreement was signed, nearly 15,000 Iraqi soldiers abandoned their equipment, took off their uniforms, and attempted to either blend into the population or return to their homes.⁷³ Six ODAs and the peshmerga fighters entered the city of Mosul in an attempt to fill the power vacuum created by the departure of the Iraqi military. However, it was also important to make it clear to the Turks that Mosul was not under the control of the peshmerga. At the request of JSOTF-N, General Mustafa had his forces pull out of the city and left FOB 102 in control. The city was then divided into six sectors and responsibility for each sector was assigned to an ODA.

On April 11 the commander of CENTCOM directed that the 26th MEU (Special Operations Capable) be deployed to northern Iraq with the capability “of reinforcing northern operations.” On 24 hours’ notice, the 26th MEU departed from Cyprus on C-130 aircraft, landed at the Irbil airfield, and immediately fell under the tactical control of JSOTF-N.

⁷⁰ “U.S. Increases Order for Combat-Tested Javelin,” p. 3.

⁷¹ Thom Shanker, “How Green Berets Overcame the Odds at an Iraqi Alamo,” *New York Times*, September 22, 2003.

⁷² Moore, *Hunting Down Saddam*, pp. 46–51.

⁷³ Cleveland interview.

As soon as the commander of Battalion Landing Team (BLT) 1/8 arrived at Irbil on April 12, he asked Colonel Cleveland, "What can we do for you?" Colonel Cleveland responded by saying that he wanted the 26th MEU to head toward Mosul on the morning of April 13 and, once there, reinforce FOB 102.⁷⁴ The BLT commander replied by saying, "We didn't come here to sleep," and he immediately took actions to conduct a helicopter insertion into Mosul.⁷⁵ That evening JSOTF-N provided MH-53s to shuttle the marines from Irbil to the airfield at Mosul. By sunrise on April 13 the BLT had secured the Mosul airfield and was conducting operations in support of FOB 102.⁷⁶ These operations included establishing roadblocks, conducting urban patrols, ensuring that roads remained open and trafficable for both military and civilian vehicles, and searching for weapons caches. The 26th MEU remained in Mosul until the 101st Airborne Division assumed responsibility for the city on April 22. During this time Colonel Cleveland met with the tribal leaders of Mosul (see Figure 4.18) to gain their support in establishing local control of the population.⁷⁷ Following the seizure of Mosul, elements of FOB 102 and FOB 050 conducted unconventional warfare operations in the western desert of northern Iraq.

173rd Infantry Brigade (Airborne) and the Seizure of Kirkuk. During early planning efforts for operations in northern Iraq, the two airborne infantry battalions of the 173rd Infantry Brigade (Airborne) were slated to be placed OPCON (under operational control) to the 4th Infantry Division (Mechanized) and to fight as part of a British-led corps. By late fall in 2002, Turkey had made it clear that it would not grant the United Kingdom access to either its airspace or its territory to move forces into northern Iraq. Planning for deployment of the 173rd as part of the 4th Infantry Division continued in earnest throughout the remainder of 2002. This planning revolved around movement to Turkey by sea, followed by a land movement into northern Iraq. Upon its arrival in Iraq, the 173rd was to be reinforced by Task Force 2-14 Infantry from the 10th Mountain Division, providing a third maneuver battalion for the operation (the 173rd had only two organic maneuver battalions at the time of OIF).⁷⁸

In October 2002, the EUCOM J-3 (operations staff) became concerned that Turkey might not grant the 4th Infantry Division authority to transit its territory. Consequently, a warning order was issued to the 173rd directing it to begin initial planning for an airborne insertion into the KAZ in support of JSOTF-N.⁷⁹

⁷⁴ Cleveland interview.

⁷⁵ Captain (USMC) Arnaldo Colon, Command Historian, 26th Marine Expeditionary Unit, "U.S. Marines in North Iraq: A Certain Force," undated, p. 12.

⁷⁶ First Lieutenant (USMC) Christopher Mercer, "Charlie Company Leads BLT into Northern Iraq," 26MEU Public Affairs Office, 2003, p. 1-2.

⁷⁷ Cleveland interview.

⁷⁸ Interview with 173rd Infantry Brigade (Airborne), Vicenza, Italy, June 16, 2004.

⁷⁹ Cleveland interview.

Figure 4.18
Colonel Cleveland with Tribal Leaders in Mosul



SOURCE: "U.S. Marines in North Iraq: A Certain Force," p. 26.

RAND MG641-4.18

In January 2003, a planning meeting was held at Southern European Task Force (SETAF) headquarters to discuss the possibility of the 173rd Infantry Brigade (Airborne) being placed OPCON to SOCCENT and, further, being placed under the tactical control (TACON) of JSOTF-N. During this meeting, SETAF planners made it clear that while the employment of the 173rd Brigade as part of JSOTF-N was an option, it was not viewed as likely to occur. Consequently, planners at JSOTF-N did not initiate detailed planning for this possibility, and neither did the 173rd. As a result of this meeting, however, the two organizations did establish closer coordination, to include the assignment of a liaison officer from the 173rd to the headquarters of JSOTF-N.⁸⁰

As specified by SOCCENT, the mission of the 173rd Infantry Brigade (Airborne) was to provide "a *demonstration* of U.S. resolve [in support of] CJSOTF-N [Combined Joint Special Operations Task Force–North] operations [in order to] *prevent* the movement of IZ [Iraqi] divisions north of the Green Line [line of confrontation] and deter autonomous faction operations in Northern Iraq." The brigade was further directed to

⁸⁰ Cleveland interview.

be prepared to secure key oil facilities in the vicinity of Kirkuk. The order from Commander, Special Operations Component Command (COMSOCC) continued with the following specific guidance to the 173rd:⁸¹

- Deploy the two airborne infantry battalions of the 173rd into northern Iraq.
- Provide sufficient mobility so that one of these battalions can move rapidly to seize critical oil nodes in and around Kirkuk.
- Be prepared to establish a strong point defense at these critical oil nodes.
- Do not, initially, deploy the Human Resources Command/Materiel Readiness Command due to the C-17 requirements.

To accomplish its mission, the 173rd Infantry Brigade assembled a task force built around 1-508 Airborne Infantry and 2-503 Airborne Infantry battalions. Task Force 1-63 included elements of the 1-63 Armor: five Abrams tanks, five Bradley fighting vehicles, one mechanized infantry company equipped with nine M-113 vehicles, and part of a forward support battalion. Portions of the headquarters of 1-63 Armor Battalion would also accompany the armored vehicles to Iraq. Task Force 1-63 also included 319th Airborne Field Artillery and other supporting elements.

Significant disagreement arose between the 173rd Infantry Brigade and the special operations planners regarding the employment of armor in northern Iraq. However, from the time it was alerted to the mission in northern Iraq, the 173rd included armor in its planning and concept development. The inclusion of Task Force 1-63 was strongly supported by General Burwell B. Bell, the U.S. Army Europe (USAREUR) commander, who insisted that the 173rd be reinforced with armor.⁸² Both SOCCENT and the commander of JSOTF-N, however, thought that the inclusion of armored vehicles was not necessary for the type of operation they would be conducting in northern Iraq. Moreover, SOCCENT believed that the deployment of Task Force 1-63 not only would cause a drain on available lift assets but would also be extremely difficult to sustain logistically. From the perspective of JSOTF-N, the value-added of a limited number of Abrams tanks and Bradley fighting vehicles was far overshadowed by the cost of moving and employing such a force.⁸³ The issue was finally settled by the CFLCC, who agreed to the inclusion of a small amount of armor with the 173rd.⁸⁴

On March 23, a team of special operations forces flew into northern Iraq in MC-130 aircraft. The same day, a drop zone team flew from Vicenza, Italy, to Constanta, Romania, the staging base for special operations forces going into northern

⁸¹ COMCFSOCC, "Guidance on 8 March 2003 (CONOP for 173rd ABN BDE in Northern IZ)," presentation, March 8, 2003, Slide 29.

⁸² 173rd Infantry Brigade (Airborne) interview, 2004.

⁸³ Cleveland interview.

⁸⁴ 173rd Infantry Brigade (Airborne) interview, 2004.

Iraq. The team included personnel from the 173rd Infantry Brigade (Airborne) and Air Force tactical air controllers. One half of ODA 064 accompanied the team. A separate drop zone team flew over Turkey into northern Iraq in MC-130s and landed during the night at the Bashur airfield. The other half of ODA 064 met this team at the airfield. It spent the night in a Special Forces “safe house” protected by peshmerga. Early in the morning of March 26, SOF personnel drove team members back to the Bashur airfield, which consisted of a single runway among rolling hills with running water at both ends. The surrounding terrain was plowed and damp—to the extent that soldiers sunk down in mud to the tops of their boots. The team set up satellite communications and reported that the drop zone around the airfield was suitable but that clouds were down to 1,000 feet, too low for aircraft to maintain safe altitudes. Fortunately, the weather cleared before the drop.

The special operations survey of the runway at Bashur led to the conclusion that only a limited number of C-17 landings could be made before the runway would crack under the weight of the loaded aircraft. The initial estimates were that about 70 loaded C-17s could land before the runway failed. The 173rd required roughly 60 aircraft to bring in its organic equipment. Additionally, the Air Force airfield operations teams would need several aircraft loads to bring in their personnel and equipment. The SOF presence would grow once the airfield was secured, thus requiring several additional landings. Finally, there was the issue of daily resupply aircraft landing at Bashur. The capacity of the airfield, therefore, would be pushed to its likely limit, and would quickly reach estimated failure point. For this reason, the 173rd elected to conduct an airdrop as opposed to an air landing for the initial deployment. Ten C-17s were dedicated to airdropping personnel and five to dropping heavy equipment. Therefore, 15 landings on the runway were saved by conducting a parachute operation.⁸⁵

At 8:00 P.M. on March 26, a stream of 15 C-17 aircraft flew through Turkish airspace into northern Iraq carrying elements of 1-508 Airborne Infantry, 2-503 Airborne Infantry, one battery of field artillery, combat engineers, air defenders, a surgical team, and members of the 10th Special Forces Group. The first five C-17 aircraft dropped heavy equipment, and the following aircraft dropped personnel. Of those scheduled to jump, 959 personnel were able to exit the aircraft before a red light signaled the end of the jump, leaving 36 soldiers still aboard the aircraft. It would have been too dangerous for these men to jump, because the pilots were under instructions to apply power and climb, which created a dangerous backwash.⁸⁶ The soldiers landed along the entire length of the 10,000-meter drop zone and took all night to assemble, slogging through

⁸⁵ 173rd Infantry Brigade (Airborne) interview, 2004. The 173rd has a significantly different table of organization than the 82nd Airborne Division. In particular, the 173rd's battalions have far more vehicles. This gives the unit much more tactical mobility than the 82nd Airborne, but it does mean that a larger number of aircraft are needed to deploy the unit.

⁸⁶ Fontenot, Degen, and Tohn, p. 284.

the deep mud. During the following days, 12 C-17 aircraft landed at the Bashur airfield each day, closing the paratroopers and their equipment in four days. In all, the 173rd required 62 C-17 sorties, and elements of the 1-63 Armor required an additional 27 C-17 sorties. The entire task force required about 10,000 gallons of fuel per day, most delivered under contract by Turkish companies. Although the original estimate of runway failure at Bashur was 70 C-17 landings, the runway actually held up for approximately 100 landings.

Particularly problematic for SOCCENT was the response of the 173rd Infantry Brigade (Airborne) to tactical directions given by both JSOTF-N and the commander of SOCCENT. Although the 173rd officially was OPCON to SOCCENT, and TACON to JSOTF-N, all contested orders were forwarded to SETAF headquarters. This backchannel communication between the 173rd and its parent unit in EUCOM caused significant conflict, which resulted in the personal intervention of three- and four-star generals within EUCOM and CENTCOM.⁸⁷

Even though the 173rd was under the tactical control of JSOTF-N, the SOF logistical structure was unable to meet the needs of a conventional brigade, especially one that included roughly 20 armored vehicles and dozens of soft-skinned wheeled transports of various types. Starting soon after the Bashur airfield was secured, EUCOM provided two C-17s per day to resupply the brigade. This process continued after the larger and more capable airport at Kirkuk was seized. Indeed, until roughly mid-July the daily arrival of C-17s from Germany provided the brigade's logistical lifeline.⁸⁸ While the staff of the 173rd complained about the inability of JSOTF-N to provide logistical support, it must be recalled that Task Force 1-63 was deployed over the objection of Brigadier General Harrell for this very reason.

On April 8 the brigade received orders to begin moving toward Kirkuk. It was to take part in an operation designed to allow FOB 33 and a large contingent of peshmerga fighters to advance toward Kirkuk after air strikes had virtually eliminated Iraqi military resistance along the line of confrontation. To help ensure that the advance did not threaten Turkey, the peshmerga were directed not to organize in groups of larger than 150 fighters, not to seize the oil fields, and to stop their advance on the outskirts of Kirkuk, allowing the 173rd to pass through and seize the city.⁸⁹ Although the final assault was planned for April 15, during the rapid advance opposing Iraqi units began to desert en masse. By the time the peshmerga and Special Forces arrived at Kirkuk on April 10, the Iraqi military had abandoned the city, leaving behind hundreds of T-55 and T-72 tanks, all types of military vehicles, and ammunition depots brimming with weapons, ammunition, and military uniforms.⁹⁰

⁸⁷ Mitchell interview.

⁸⁸ 173rd Infantry Brigade (Airborne) interview, 2004.

⁸⁹ COMCFSOCC J3 to CJSOTF-N J3, "Seizure of Kirkuk CONOP," message, 090850Z APR 03.

⁹⁰ Moore, *Hunting Down Saddam*, p. 30.

Understanding Turkish opposition to Kurdish occupation of Kirkuk, as well as the potential for Turkish intervention, the JSOTF-N commander directed that the 173rd Brigade rapidly advance into the city to reestablish order.⁹¹ Simultaneously, the peshmerga were directed to move back to the previously established limit of advance, an order that General Mustafa quickly enforced upon the arrival of the 173rd on April 14.⁹²

During the movement toward Kirkuk, the 173rd Brigade brought 120mm mortars and 105mm howitzers forward and fired on Iraqi forces on two occasions. However, the brigade only engaged in a couple of minor conventional combat operations before major combat operations ended.⁹³

Joint Special Operations Task Force–West

The task of preventing the Iraqi military from using missiles to attack either neighboring countries or coalition forces was assigned to Colonel John Mulholland, the commander of the Army's 5th SFG (Airborne) and the newly designated commander of Joint Special Operations Task Force–West (JSOTF-W). The area of responsibility for JSOTF-W included the entire western desert and all the terrain from the border of Kuwait north to Baghdad. In addition to denying the Iraqi military the ability to launch missiles from the western desert, JSOTF-W was charged with seizing key airfields and controlling lines of communication in the west, preventing Iraqi regular forces from operating in the western desert, conducting strategic reconnaissance and unconventional warfare in support of the CFLCC's operations plan, and working with Iraqi nationals who were supportive of the coalition's plan to oust Saddam Hussein from power.⁹⁴

Ultimately, although elements of JSOTF-W conducted numerous operations to locate and destroy any remaining mobile missile launchers, they failed to find any operational launchers. However, in the subsequent search of the H-3 complex,⁹⁵ Australian

⁹¹ 173rd Infantry Brigade (Airborne) interview, 2004.

⁹² Cleveland interview.

⁹³ 173rd Infantry Brigade (Airborne) interview, 2004.

⁹⁴ General Bryan D. Brown, Commander of U.S. Special Operations Command, *Testimony Before United States House of Representatives Committee on Armed Services Subcommittee on Terrorism, Unconventional Threats and Capabilities*, March 11, 2004.

⁹⁵ From GlobalSecurity.org, "H-3 Airfield," June 22, 2005:

The H-3 Southwest airfield [was] one of three dispersal airfields in the H-3 base cluster located 435 kilometers from Bagdad in western Iraq. The main H-3 airfield was originally built to support the H-3 oil pumping station. H-3 Main [was] supported by two dispersal airfields, H-3 Southwest, and H-3 Northwest, and a Highway strip, 42 kilometers to the west. H-3 Southwest [was] served by a single 9,700 foot runway and [had] a parallel taxiway that could be used as an alternate runway. There [were] at least 6 hardened aircraft shelters, and 6 revetments.

Special Air Service (SAS) found “specialized cranes, missile launchers, fuel tanks, and [chemical] storage systems—but no chemicals.”⁹⁶

The border between Iraq and Syria is a winding frontier that extends 500 kilometers through rugged terrain. Arab nomadic tribes populate the area and make money smuggling people, arms, oil, and contraband across the porous border. One of the key missions assigned to JSOTF-W was to control this area, prevent Iraqi military forces from operating in the western desert, and stop high-value targets (HVTs) from fleeing Iraq and escaping to Syria.

Naval Special Warfare Task Group Central (TG-Cent)

The third special operations task force created by SOCCENT was organized around elements of Naval Special Warfare Group One, commanded by Commodore Robert Harwood. Naval Task Group Central (TG-Cent) was given the mission of securing key oil terminals, pipelines, manifold stations, and other strategic targets that were in Iraqi littoral areas such as the narrow Khawr Az Zubayr waterway that connects Umm Qasr, Iraq’s only deep water port, to the Persian Gulf.⁹⁷ Specifically, Naval Special Warfare forces were directed to:⁹⁸

- Prevent Iraqi sabotage of POL (petroleum, oil, and lubricant) facilities, catastrophic release of oil, and damage to oil infrastructure
- Deter Iraqi maritime mining or resupply
- Monitor Iranian neutrality
- Support CFLCC ground maneuver.

According to Commander Larry Metz, more than 250 Navy SEALs participated in OIF, their largest deployment since Vietnam.⁹⁹ Further, an additional 250 personnel were deployed from Naval Special Warfare Group to provide such skills as intelligence support and boat drivers for the SEAL teams.

Task Force 20 (TF-20)

Task Force 20 was made up of classified specialized forces units and operated under the direct control of CENTCOM. Two of its operations, rescuing PFC Jessica Lynch and the defense of the Hadithah Dam, were widely reported in the press.

Rescuing PFC Jessica Lynch. On March 29, an Iraqi lawyer named Mohammed Odeh al-Rehaief contacted men from 3-2 Marines south of the city. Al-Rehaief said that he had seen a female American soldier being treated as a patient in the Saddam

⁹⁶ Robert Wimmer and Paul Ham, “Missile Base Seized by SAS,” *Sunday Times*, March 30, 2003.

⁹⁷ Brown, March 11, 2004.

⁹⁸ NSWTF CENT, “Supporting Plan to COMSOCCENT 1003V Supporting Plan,” undated.

⁹⁹ James W. Crawley, “SEALs Give Glimpse of Missions in Iraq,” *San Diego Union-Tribune*, June 27, 2003.

Hospital located on the western outskirts of An Nasiriyah north of the Euphrates. TF-20 arrived and began planning to rescue this soldier with support from Task Force Tarawa. About the same time, Tarawa directed air strikes in the Suq Ash Shuyukh area southeast of An Nasiriyah, which was still serving as a conduit for Iraqi infiltration into the city. During the night of April 1–2, TF-20 rescued PFC Jessica Lynch from the Saddam Hospital. Just prior to the rescue, 15th Marine Expeditionary Unit attacked the southwestern bridge over the Euphrates to divert the Iraqis' attention. The 3rd Marine Air Wing lifted Rangers by helicopter into a landing zone east of the hospital. Rangers also arrived by ground convoy from the north to secure the area. The rescue team came from the south in MH-6 "Little Bird" helicopters. Task Force Tarawa kept quick reaction forces poised at the northern and southern sides of the city.

Ba'ath Party leadership and Fedayeen had been using the Saddam Hospital as a command post, but these men changed into civilian clothes and fled the hospital earlier on April 1. Lynch was in an intensive care ward where Iraqi physicians had done their best to treat her. They had given her three bottles of whole blood, two of them taken from the hospital staff because no stocks were available.¹⁰⁰ The rescue team encountered no resistance inside Saddam Hospital. As the team members went through the wards, Lynch could hear their voices calling: "Where is Jessica Lynch?" Unsure whether the voices were American or Iraqi, Lynch lay still in her bed, afraid to respond. At last one of the team walked into her room and stood at her bedside. He said: "Jessica Lynch, we're United States soldiers and we are here to protect you and take you home." Lynch said the first thing that came into her head: "I am an American soldier, too."¹⁰¹

The rescue was highly successful and set a good example for coordinated efforts involving special operations forces and conventional forces.

Defense of the Hadithah Dam. The Hadithah Dam is located on the Euphrates River approximately 125 miles northwest of Karbala. Prior to the initiation of OIF, the Army Engineer Research and Development Center (ERDC) conducted an analysis of the impact the destruction of this hydroelectric facility could have in Iraq. The ERDC concluded that the resulting flooding would create potentially catastrophic effects throughout the country. In addition to the adverse impact that flooding would have on the U.S. advance, the ERDC believed that the resultant water shortage was likely to cause severe hardships for the Iraqi people during the summer months.¹⁰²

On April 1, soldiers from the 3rd Battalion, 75th Infantry (Ranger), and other elements of TF-20 conducted an airborne insertion to seize the Hadithah Dam during

¹⁰⁰John Kampfner, "The Truth About Jessica Lynch," *The Guardian*, London, May 15, 2003.

¹⁰¹Rick Bragg, *I Am a Soldier, Too, The Jessica Lynch Story*, New York: Alfred A. Knopf, 2003, p. 131.

¹⁰²Debbie Quimby, "ERDC Contributes to Operation Iraqi Freedom from the Home Front," *ERDC Information Bulletin*, December 5, 2003.

hours of darkness.¹⁰³ The raid took the small number of Iraqi defenders by surprise and TF-20 quickly gained control of the structure, preventing Iraqi forces from employing the dam as a weapon of mass destruction. After the seizure, the Rangers began to take heavy mortar and artillery fire from the nearby town of Hadithah, located just south of the dam. On April 2 the Iraqi military launched a major counterattack that was repulsed by the Rangers, who were well reinforced by close air support. Although the initial counterattack was defeated, the Rangers were repeatedly attacked by Iraqi forces who were determined to regain control of the dam and its associated hydroelectric facility. Over the course of the next three weeks, the Rangers called in hundreds of air strikes against Iraqi forces attacking to regain control of the dam. The Rangers continued to hold this position until April 19, when the 1-502 Infantry Battalion from the 101st Airborne Division relieved them.¹⁰⁴

The WMD Campaign

A primary CENTCOM concern was to locate weapons of mass destruction (WMD).¹⁰⁵ After all, their certain existence was the central reason for the invasion of Iraq. Intelligence sources had developed an extensive list of sites where WMD were likely stored or processed and from where they could be launched against coalition forces or friendly U.S. allies such as Israel and Kuwait. Their location was therefore a paramount concern for the administration. In addition to locating the sites, it was important that they be thoroughly searched for any traces of WMD to confirm the regime's possession of WMD. WMD played a central role in OIF, affecting everything from diplomacy, to planning, to the conduct of the operation. Chapter Three showed that the WMD threat was discussed from the start of General Franks's meetings with the President and Secretary of Defense. And, as noted elsewhere, the issue of WMD also dominated the concurrent diplomatic efforts.

At the time, the threat to U.S. forces seemed credible. Twelve years earlier, the United States had prepared to face WMD on the battlefield, in part because Saddam had used chemical weapons on his own people. In the first Gulf War, however, coalition forces did not directly threaten the regime. In this war, the regime was the target.

¹⁰³For additional background on Hadithah Dam, see Michael R. Gordon and Bernard E. Trainor, *Cobra II, The Inside Story of the Invasion and Occupation of Iraq*, New York: Pantheon Books, 2006, pp. 331–335.

¹⁰⁴Fontenot, Degen, and Tohn, p. 310.

¹⁰⁵The term *WMD* will be used throughout this section in reference to chemical, biological, or nuclear weapons and programs. Although there are significant differences among these weapons, we use this general term because it was used by the military throughout the campaign.

The U.S. military not only had to be prepared to fight in a WMD environment but also had to find, secure, and dispose of any weapons or stockpiles it found.¹⁰⁶

This discussion does not address the political debate about the war or whether Iraq actually had chemical, biological, or nuclear weapons at the time of the war. Instead, it focuses on a single question: “How did the U.S. military plan for and execute its counter-WMD campaign assuming that Iraq possessed and might use WMD?” In doing so it will examine the planning, the operations, and the evolution of the mission.

Planning and Preparation

Even seven years after the first Gulf War, United Nations inspectors continued to uncover evidence of WMD. This was due to an elaborate system of deception and denial that created the impression the Iraqi regime had something to hide.¹⁰⁷ After Saddam Hussein expelled the UN inspectors in 1998, many experts concluded that he probably retained WMD capabilities and that he was likely to restart WMD programs. Even after the inspectors returned in the fall of 2002, their reports to the UN continued to indicate less than complete cooperation on the part of the Iraqis in the face of imminent invasion. In his first report after UN inspectors returned to Iraq, Dr. Hans Blix stated, “Iraq has not genuinely accepted the UN resolution demanding that it disarm and while Baghdad is cooperating on access, it needs to do more on substance.”¹⁰⁸ Thus, it is not surprising that the issue of WMD formed a major component in CENTCOM’s war preparations.

Planning at CENTCOM

The planning by General Franks’s staff led to a WMD campaign with three major components: protect forces and partners, prevent use, and conduct sensitive site exploitation (SSE) operations¹⁰⁹ to search for and neutralize WMD weapons and programs.

Protect Forces. We have found no specific evidence that any special measures were taken to protect forces from attack by nuclear or radiological (dirty bombs) weapons other than the dispersal measures taken to reduce the effectiveness of chemical attacks. This may reflect the fact that none of the intelligence estimates or detectors

¹⁰⁶At the time there were no credible indications that Iraq possessed any operational nuclear weapons. The likeliest threats were chemical and, possibly, biological weapons.

¹⁰⁷David Kay, “Denial and Deception,” in Roy Godson, Ernest R. May, and Gary Schmitt, *U.S. Intelligence at the Crossroads*, Washington, D.C.: National Strategy Information Center, Inc., 1995.

¹⁰⁸Joseph Fitchett, “In UN Report, Ammunition for 2 Sides,” *International Herald Tribune*, January 28, 2003.

¹⁰⁹A sensitive site is a geographically limited area with special diplomatic, informational, military, or economic sensitivity to the United States. Sensitive site exploitation refers to a related series of activities taken by U.S. government forces inside a captured sensitive site that exploit personnel, documents, electronic files, and material captured at the site, while neutralizing the threat posed by the site or any of its contents. From U.S. Army, ST 3-90.15: *Tactics, Techniques and Procedures for Tactical Operations Involving Sensitive Sites*, Fort Leavenworth, Kansas, December 2002.

indicated that Iraq had a nuclear weapon before the war. The lack of evidence of anti-nuclear protective measures being taken may also be an artifact of incomplete data. Such measures would have included radiation detectors, which are carried by NBC (nuclear, biological, and chemical) units, as well as the stockpiling of pharmaceuticals to reduce the biological effects of radiation exposure.

It is impossible to assess how U.S. forces would have responded had WMD been used against them, especially in the midst of combat. Evidence seems to suggest, however, that the units were as well prepared to operate in a chemical environment as was feasible at the time. For example, troops were trained and equipped to operate in chemical protection suits. There were several instances of troops employing these in the early days of the campaign, usually during mortar attacks, without any obvious difficulties. The maneuver units had their own chemical officers who were capable of providing initial analysis and response as well as a number of chemical response units. The latter were responsible for consequence management in case of an attack. In addition, troops were provided with vaccination against biological agents, and warning and interdiction systems such as Patriot batteries were employed.

Prevent WMD Use. Preventing the use of WMD was the second major thrust of CENTCOM's WMD campaign. This included a combination of deterrence, air, and SOF attack operations against fixed and mobile targets, and an extensive information operation to dissuade Iraqis from using the weapons against coalition forces or regional coalition partners. Illustrating how seriously CENTCOM took the ballistic missile threat, CENTCOM J-2 (intelligence staff) kept a running tally of ballistic missiles and UAVs that were captured, destroyed, or launched during the conflict. This tally was compared with a prewar estimate of the total Iraqi inventory for each type of missile or UAV and was a standard part of the daily intelligence updates via SIPRNET.¹¹⁰

SOF also played an important role in attack operations against Iraqi delivery systems. Their focus was on western Iraq, from where Iraq had fired all of its ballistic missiles against Israel in the 1991 Gulf War. The primary targets in this effort were H1 and H3, airfields that had been associated with missile launches in 1991. Much of the SOF effort remains classified and cannot be discussed here.

Another element of the strategy to prevent WMD use against coalition forces and allies was the information operations (IO) campaign to persuade Iraqis not to use the weapons. As discussed elsewhere, coalition forces conducted an extensive IO campaign before, during, and after the war to achieve a variety of objectives, including preventing the use of WMD. Figure 4.19 shows an example of one of the leaflets dropped by the coalition into Iraq before and during the campaign.

Conduct SSE Operations. The third component in General Franks's strategy was to conduct SSE operations. This was not a new concept, as SSE operations had been

¹¹⁰The SIPRNET (Secret Internet Protocol Router Network) is the military's classified (through SECRET) Internet.

Figure 4.19
Sample Leaflet Designed to Discourage WMD Use



SOURCE: U.S. Central Command.

RAND MG641-4.19

conducted at the An Nasiriyah Southwest Ammunition storage facility in the first Gulf War. Since that time, however, SSE had remained primarily a function of Special Forces. Operations in Afghanistan had led to a significant increase in the number of SSE operations, and the lessons from that conflict would influence the approach taken in Iraq. For example, the lack of centralized coordination led to confusion in the field, sometimes with people just showing up at a site already under investigation.

Throughout much of the year 2002, CENTCOM planners were transforming General Franks's strategy into an actual military plan, OPLAN 1003V. The SSE mission would be explicitly laid out in one of the many appendixes. Once the initial concept was drafted, primary responsibility for the details passed to Combined Forces Land Component Commander (CFLCC).

Creating the Exploitation Task Force (XTF)

Major General James "Spider" Marks was appointed director of CFLCC's intelligence section, the C-2, in September 2002.¹¹¹ Among other responsibilities, this section was tasked with the writing of the component plan, COBRA II. In October the C-2 moved

¹¹¹ C-2 can refer to either the section staff or Major General Marks himself; in this section it refers to the entire section.

to Camp Doha, Kuwait. Starting with personnel from the 513th Military Intelligence Brigade and the C-5 Operations Planning Group, the C-2 would grow from 50 to over 440 people.¹¹²

By November, WMD-related work was advancing on two main tasks, the first being identification of the sites. The intelligence community, led by the Defense Intelligence Agency (DIA), was responsible for identifying all possible WMD targets and creating the WMD Master Site List (WMSL). As of April 1, 2003, it had 527 sites, which were prioritized on a scale from 1 to 5. Those rated a 1 (best candidate site) or 2 (likely to be associated with proscribed WMD and ballistic missile activity) were assigned for SSE. The C-2 was then responsible for creating target folders to be used in the actual campaign.

Officers from the 513th and C-2 plans sections would be largely responsible for planning the SSE operation. The first change to previous SSE operations was agreement on having a designated headquarters element. In Afghanistan, there had been no central coordinating body, and this vacancy had led to confusion in the field. The planners also anticipated the need to handle a variety of different kinds of intelligence during the operation, which was supposed to be handled by something called an intelligence exploitation base (IEB).¹¹³ Originally the 513th was supposed to retain control over the IEB, but eventually it would be integrated within the larger SSE task force to consolidate efforts.

The next issue was who would actually carry out the exploitation missions. The Mobile Exploitation Team (MET) concept seems to have been created first. The concept was clear: a group of NBC experts supported by military personnel, who would be able to visit the sites. The fact that this would be going on during combat, however, led planners to create a new concept, that of the Site Survey Teams (SSTs). The SSTs would deploy with the maneuver units. They would be teams of 26 people, with command and security provided by the military accompanying a fixed number of NBC experts. The SSTs were designed to go into a site after their maneuver unit had secured it ostensibly because some of the team members were to be civilians. This was called a semi-permissive environment. The security of the environment would later become an issue of contention between the civilians and the soldiers in some of the SSTs. Each SST would be equipped with two Fox vehicles, which could provide high-quality field analysis.¹¹⁴

¹¹²U.S. Army Intelligence Center and Fort Huachuca, *Intelligence Officer's Battlebook*, "Chapter 2: Evolution of CFLCC C-2," June 26, 2003.

¹¹³During the planning phase, the task force headquarters was often referred to as the IEB. When the 75th Field Artillery Brigade was finally chosen for the mission, it became known as the 75th IEB. No one seemed to like this, however, so someone proposed calling it the 75th Exploitation Task Force. It quickly became known as the 75th XTF and was referred to as such during the war.

¹¹⁴The Fox vehicle is a six-wheeled, light armored NBC Reconnaissance Vehicle with onboard NBC detection capabilities. Its main analytical capability is an MM-1 Mobile Mass Spectrometer.

Figure 4.20 shows the organizational structure for a typical SST. The Defense Threat Reduction Agency (DTRA) referred to its embedded team as an SAT, which stands for Site Assessment Team. According to DTRA, the SSTs were to “Confirm/Deny Presence of Sensitive Materiel or Persons of Interest.”¹¹⁵

In comparison, the METs would be larger. Although the number of military personnel would be fixed, they would be task-organized for each mission. They would be able to do this because the METs would operate out of the task force headquarters, drawing upon the pool of experts stationed there. Given the distances involved, this meant the METs would be air-mobile, and for this purpose a battalion of National Guard Chinook helicopters were included in the METs. The METs would be responsible for providing a gold-standard analysis on any WMD found, a level that would be accepted by the international community. The Chemical Biological Intelligence Support Team (CBIST) was responsible for two advanced laboratories designed to handle biological and chemical weapon samples, which would also be stationed at headquarters.¹¹⁶ Additionally, samples would be transported back to laboratories in the United States.

Figure 4.20
SST Organization

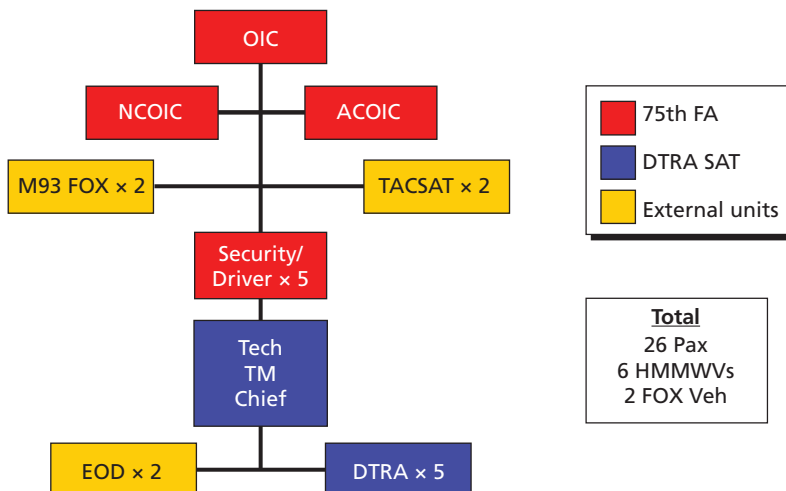

NOTE: The 75th provided the officer in charge (OIC), noncommissioned officer in charge (NCOIC), another officer, and a driver and five people for security. There were also two members of explosive ordnance disposal (EOD), two communications experts (TACSAT), and two Fox vehicles. DTRA supplied a team leader and five experts.

SOURCE: DTRA. “Site Assessment Team (SAT),” March 2003 briefing.

RAND MG641-4.20

¹¹⁵ DTRA, “Site Assessment Team (SAT),” March 2003 briefing.

¹¹⁶ Judith Miller, “Chemical Biological Intelligence Support Team,” *New York Times*, March 23, 2003, p. B5.

On December 18–19, 2002, the C-2 hosted a conference to brief the SSE concept of operations (CONOP), exchange information on capabilities, fully develop the SSE CONOP, and generate a request for forces (RFF). Over 100 representatives from CENTCOM, V Corps, I MEF, the intelligence community, and force providers attended. After further refinement, Major General Marks approved the CONOP and the RFF. This included requests for chemical and biological teams, specialized intelligence support teams, laboratories, technical escort elements, special media exploitation, aviation, communications, and a headquarters element, which was chosen at this time. At this point, the C-5 section took final responsibility for the plan.

This was also the point at which Major General Marks approved the choice of the 75th Field Artillery Brigade as the SSE headquarters and support element. Thus, it was not until the end of December 2002 that members of the 75th Field Artillery Brigade learned they would be responsible for SSE operations in Iraq. They would have roughly two months to completely retrain, refine doctrine, and deploy to Kuwait.

Two reasons favored the choice of the 75th Field Artillery Brigade to lead the SSE mission. First among these was probably its availability. The brigade had spent the fall preparing to provide artillery support to the 4th Infantry Division during its invasion through Turkey, even participating in the mission rehearsal exercise. In the end, however, Lieutenant General McKiernan decided to only take two of its battalions—the 1-17 and the 6-27.¹¹⁷ This meant that the rest of the unit remained on the deployment schedule for Iraq but unassigned. Second, the 75th possessed several capabilities that would be needed in the SSE mission. These included some organic communications capabilities, a headquarters staff, some transportation, and personnel who were familiar with how maneuver units operated. These capabilities would be important in an operation in which vast distances would be involved.

In early January, another conference was held at Fort Sill, Oklahoma, to present the SSE concept to the 75th Brigade. Team members then spent the next month further refining the team structures, creating the necessary TTPs,¹¹⁸ deploying, and training. This preparation included exercises in Kuwait. Several team members felt that the training they managed to conduct, even in so short a period of time, was crucial to how they performed in Iraq and to the absence of any injuries to members of the team.

Four SSTs deployed with maneuver units at the beginning of the war. The 3rd Infantry Division had tactical control of SSTs 1 and 4, while SSTs 2 and 3 moved with I MEF. The limited number of teams, given the size of Iraq, meant that preliminary testing would also be the responsibility of chemical officers from individual units. There were at least three METs when the war began (A, B, and C), with D added mid-campaign. The XTF headquarters was in Kuwait when the war began but would

¹¹⁷ Lieutenant Colonel Vincent L. Price, Major Dale E. Owen, and Chief Warrant Officer Richard L. Gonzales, “75th FA Brigade: SOSO in OIF and BCT at the NTC,” *Field Artillery Journal*, March–June 2004.

¹¹⁸ Techniques, tactics, and procedures.

move twice during the war. It was first relocated to Tallil Air Base and then finally to Baghdad.

Colonel Richard McPhee commanded the XTF. In addition to its own personnel, the XTF added civilians and soldiers from the 52nd and 787th Explosive Ordnance Detachments, 1-147 and 1-159 Aviation Battalion, 87th Chemical Battalion, 513th Military Intelligence Brigade, DTRA, DIA, and soldiers from UK and Australia. It would eventually have over 400 personnel.

A Brief History of the 75th XTF in Iraq

The 75th XTF was prepared to go into Iraq, find stockpiles of weapons, identify them as proof of Iraqi noncompliance, and then secure them. Although no WMD ultimately were found, the XTF's experiences were interesting. Almost immediately, the XTF began to adapt to the realities on the ground. The following recounts some of the activities of the XTF in Iraq, but its actions cannot be separated from the lessons it was learning along the way.

The war began on the evening of March 19, with ground troops entering Iraq on March 20. SST 4 conducted the first exploitation on March 25, at an ammunition depot. SST 2's first survey was at a former ammunition storage depot in Umm Qasr that had been liberated by British forces. Before moving on with the 3rd Infantry Division, they examined 11 bunkers at the site.

On March 31, one of the METs deployed to investigate reports of Iraqi war crimes. The team was supposed to inspect the hospital in An Nasiriyah but was unable to reach it due to the fighting.¹¹⁹ Eventually two METs, C and D, would start to focus exclusively on non-WMD issues such as suspected war crimes sites, prisoners of war, and even stolen antiquities.

MET B conducted its first survey on April 1 near the air base at Tallil. They found suspicious materials, such as protective suits and gas masks, and large amounts of conventional weapons, but no WMD. However, even at this early date, they noted that small groups of Iraqis were breaking into the bunkers at the site to steal ammunition and weapons.¹²⁰ Looting would remain a serious problem for the rest of the mission.

As expected, the maneuver units did a lot of preliminary investigation. For example, on April 3 the 3-15th Infantry Battalion, 2nd Brigade, 3rd Infantry Division, approached the Al Qaqaa weapons facility,¹²¹ engaging Fedayeen and other military units at the site. The facility consisted of more than 80 buildings and dozens of bun-

¹¹⁹Judith Miller, "Special Team Seeks Clues to Establish War Crimes," *New York Times*, March 31, 2003.

¹²⁰Judith Miller, "Smoking Gun Still Proves to Be Elusive for Searchers," *New York Times*, April 2, 2003, p. B7.

¹²¹This is the facility where apparently 337 tons of heavy ordnance went missing, including 32 tons of HMX, according to an International Atomic Energy Agency (IAEA) inspection in January 2004. This site was briefly an issue in the November 2004 U.S. elections, but it now appears unlikely that it disappeared in the four days between April 6 and April 10, 2003.

kers, with a total of six WMSL sites. The 3-15th moved on toward Baghdad, but on April 10 the 101st arrived at the site with an embedded NBC team. They found bombs and other munitions but no chemical weapons. The 75th XTF would eventually do several follow-on surveys at the facility on May 8, 11, and 27.¹²²

On April 6, 1st Battalion, 7th Regiment, marines inspected Salman Pak. This case was interesting because it is an early example of local Iraqis pointing out areas of interest.¹²³ On the same day, MET D was in Zubary, the site of a suspected war crime. As it turned out, the site consisted of remains from the Iran-Iraq War waiting to be processed.¹²⁴

On April 7, the 101st Airborne Division came across an old military training camp in Hindiya,¹²⁵ a town near Karbala. They found a large amount of chemical protection gear. Several soldiers became nauseated and noticed welts on their hands after finding eleven 20-gallon drums and three 55-gallon drums of an unknown liquid. The barrels had been hidden with palm branches in a deep trench lined with sandbags. Initial testing reported the presence of CN, a riot control agent, as well as sarin and tabun, so the 101st requested a MET survey.¹²⁶

MET A arrived on April 10. It quickly realized that the presence of organophosphates¹²⁷ was sufficient to generate a positive test for chemical nerve agents. This would help to explain the large number of false positives registered by the forward units throughout the war.¹²⁸ It was at this site that they received a note from the 101st's chemical officer, who had received it from an Iraqi named Al Muhawish who claimed to have information about chemical weapons. The note included the name and address of an Iraqi scientist.

By the time MET A arrived at the site, the fighting was essentially over, but the facility was not secure. *New York Times* reporter Judith Miller, who was embedded with the XTF and spent most of her time with MET A, noted that the team arrived to find a Shi'ite cleric supervising the removal of a giant water truck and cars; he told the team that his town did not need either American humanitarian or political assistance.¹²⁹

While this was going on, the marines came across several sites in their path. On April 7 they reached the Al Tawaiha facility, a site well known to UN inspectors. It consisted of several facilities, including one known to have had uranium yellowcake.

¹²²Department of Defense. "Al Qaqaa Weapons Facility," Talking Points, October 27, 2004.

¹²³Martin Savidge, "Fight Turns Fatal at Key Bridge," CNN, April 7, 2003.

¹²⁴Judith Miller, "Evidence Contradicts Rumors of Torture," *New York Times*, April 7, 2003.

¹²⁵MET A referred to the site as the Al Muhawish Chemical Site.

¹²⁶Bernard Weinraub, "U.S. Finds Barrels That May Hold Chemical Weapons," *New York Times*, April 7, 2003.

¹²⁷These are commonly used in pesticides.

¹²⁸Interviews with the 75th Field Artillery Brigade.

¹²⁹Judith Miller, "Hunt Finds Hint of How Iraqis Fill Power Void," *New York Times*, April 10, 2003, p. B6.

SST 3 arrived at Al Tawaitha two days later. The team documented extensive looting and recommended further exploitation by a MET but had to keep moving with I MEF. Their report noted that the security team was worried that the commander did not have enough manpower to secure the two facilities, which covered several thousand acres.¹³⁰

Meanwhile, on April 8, the 7th Marines reached Baghdad Technical College. They documented finding a series of warehouses, the first filled with sophisticated equipment for processing chemicals, the next a makeshift foundry, and next to that a roomful of metal lathes with dozens of 122mm artillery rounds sitting next to each lathe. In the fourth room they found cases for shipping artillery rounds stacked half-way to the ceiling. Despite the suspicious nature of the site and the looting that had begun, the units were ordered to move on to Baghdad.¹³¹

After Al Muhawish, MET A spent nearly a week at the Karbala ammunition production and storage facility. The site covered nearly five square miles. Initial U.S. troops had passed through without finding anything, but a second group found the first of a series of suspicious containers. The team found lab equipment and chemicals packaged in baby formula and food containers. They concluded that the materials and construction pointed toward “redundancy or dual-use, deception, and survivability.”¹³²

As had become common, the U.S. presence attracted people to the site, and locals began looting as soon as the main force moved on. Miller wrote that the team was already saying that they were unlikely to find any hard evidence without specific information from Iraqi scientists and military officers. She also reported that the teams had been struggling with resource shortages, from batteries to transportation.¹³³

Around April 16, the WMSL was incorporated into a larger database called the Iraq Master Site List (IMSL). The new list of 943 sites combined SSE designated sites into a new Priority 1 category.¹³⁴ This would not be officially announced until May. At the same time, reports surfaced that CENTCOM had started to expand security around a greater number of facilities. This was after receiving intelligence that Iraqi insiders had stolen files, electronic data, and equipment from nonconventional arms programs under the cover of generalized looting. In addition, reports were coming out that the focus of the operation was changing. “The focus of main effort has changed,” said a military officer who worked directly in the arms hunt. “Because of all the looting, coupled with [the fact that] they’re not coming up with anything on weapons,

¹³⁰Interviews with 75th Field Artillery Brigade.

¹³¹Simon Robinson, “A WMD Warehouse in Baghdad?” *Time*, April 8, 2003.

¹³²Interviews with 75th Field Artillery Brigade.

¹³³Judith Miller, “U.S. Inspectors Find No Forbidden Weapons at Iraqi Arms Plant,” *New York Times*, April 16, 2003, p. B1.

¹³⁴*Report on the U.S. Intelligence Community’s Prewar Intelligence Assessments on Iraq*, Select Committee on Intelligence, United States Senate, July 7, 2004, p. 413.

we've got to get these other sites secured. They can't afford to have stuff walking off because the clues we have right now are not leading us anywhere."¹³⁵

By this time, the XTF had been moved from Kuwait to the Tallil Air Base approximately 310 kilometers southeast of Baghdad and near the city of An Nasiriyah. Yet because most of the WMSL sites were in or near Baghdad, this would not solve the communication or transportation problems facing the METs.

After completing the Karbala exploitation, MET A took vehicles and supplies from the 101st and set out to find the scientist mentioned in the Al Muhawish note. They found him on April 20, south of Baghdad.¹³⁶ He claimed that Iraq had destroyed most of its chemical agents in the 1990s, although it had destroyed some right before the war and sent others to Syria. He also claimed that Iraq had recently focused on research and development programs that were particularly difficult for international inspectors to detect. This further encouraged the team to focus on locating people who had worked on the programs.¹³⁷

Judith Miller accompanied the team into Baghdad. She put the team in contact with the Iraqi National Congress (INC) in Iraq. Ahmad Chalabi, the INC's leader, had long been a source for Miller's reporting on Iraq and WMD issues. Following the war, the INC and Chalabi in particular came under intense scrutiny for their claims that Iraq possessed WMD. At the time, however, the contacts were sufficiently effective that MET A took two senior Iraqi scientists into custody. Jaffar Dhaj Jaffar, who founded and led Iraq's nuclear program, and Lieutenant General Amir Saadi, another top Iraqi scientist, were turned over by Chalabi's people to MET A in Baghdad.¹³⁸

While in Baghdad, MET A also contacted several Special Forces teams. Up to this point, several of the 75th XTF teams had found evidence that Special Forces had reached some of the sites ahead them. MET A was able to establish a relationship with TF-20, even loaning it four of their specialists to assist with TF-20 operations at Baghdad International Airport.¹³⁹ While in Baghdad, MET A proposed to focus exclusively on nuclear and radiological sites.¹⁴⁰

By late April, senior CENTCOM commanders publicly began backing off from expectations about finding stockpiles. On April 23, Lieutenant General McKiernan is quoted as saying,

¹³⁵Barton Gellman, "Hunt for Iraqi Arms Erodes Assumptions," *Washington Post*, April 22, 2003, p. A1.

¹³⁶Judith Miller, "Illicit Arms Kept till Eve of War, an Iraqi Scientist Is Said to Assert," *New York Times*, April 21, 2003.

¹³⁷Judith Miller, "Focus Shifts from Weapons to the People Behind Them," *New York Times*, April 23, 2003, p. A16.

¹³⁸Dana Priest, "As Iraqis Flee to Syria, U.S. Nets Scientist," *Washington Post*, April 15, 2003, p. A1.

¹³⁹TF-20 was a special operations task force under the operational control of CENTCOM, not CFLCC.

¹⁴⁰Interviews with 75th Field Artillery Brigade.

Well, first of all, you're right, we did have several hundred sites that we had some history of intelligence on that we were going to exploit. But again, this regime, over the last decade, has been pretty good at hiding material and moving it around. So it was no surprise to any of us that many of these sites that we've already exploited have not necessarily turned up the material. And we think our greatest source of finding WMD-related material or equipment is going to be from human intelligence gained from Iraqis. So a lot of this is ad hoc; as we find the intelligence, we go to exploit it.¹⁴¹

Beginning with MET A on May 3, teams began to revisit the Al Tuwaitha site.¹⁴² On May 19, MET B arrived with a Nuclear Disablement Team (NDT), which tried to mitigate the radiological hazards it found. At this point, security was being provided by a platoon from the 2-7 Cavalry. On May 25, a Direct Support Team (DST) team returned to the site to mark radiation hazards. At least two more remediation missions occurred in May.

Even as the teams continued their work in the field, senior leadership decided to change the operation significantly. On May 12, DoD officials announced that the Iraq Survey Group (ISG) would replace the 75th XTF. The ISG would have up to 1,000 experts, including some current XTF members plus about 12 former UN weapons inspectors.¹⁴³ By this date, the XTF had searched 17 of the 19 top weapons sites¹⁴⁴ and 45 of the 68 top “non-WMD sites.”¹⁴⁵

In a press conference on May 30, Dr. Stephen Cambone announced that the official transition to the ISG would begin no later than June 7. Major General Keith Dayton was assigned command of the ISG, keeping the structure within the military but significantly increasing the rank of the senior officer. According to Dayton, the most important point of the change would be to consolidate the efforts of the various intelligence-collection operations currently in Iraq under one national-level headquarters. The headquarters would be based in Baghdad but be linked to a D.C.-based intelligence cell.¹⁴⁶ Former UN weapons inspector Dr. David Kay was appointed the first

¹⁴¹CENTCOM, “Operation Iraqi Freedom Briefing with Lieutenant General David D. McKiernan,” April 23, 2003.

¹⁴²Interviews with 75th Field Artillery Brigade.

¹⁴³Chris Plante, “U.S. Civilians Take on Greater Role in Iraq,” CNN, May 12, 2003.

¹⁴⁴These included an underground facility at North Tikrit Hospital, a training camp at Salman Pak, Samarra East airport, the Military Industrialization Commission headquarters, the Baghdad Research Complex, a missile site in Taji, the Amiriyah Serum and Vaccine Institute, a munitions plant in Iskandariyah, and an underground bunker at Abu Ghraib Palace.

¹⁴⁵Barton Gellman, “Frustrated, U.S. Arms Team to Leave Iraq,” *Washington Post*, May 11, 2003.

¹⁴⁶Stephen A. Cambone, Under Secretary of Defense (Intelligence), briefing on “The Iraq Survey Group,” May 30, 2003.

special advisor to the ISG. By the end of May, the XTF had visited 337 sites and had no accidents or casualties.¹⁴⁷

Challenges on the Ground¹⁴⁸

The history above hints at the problems the 75th XTF faced as soon as it began its mission and how the reality differed from expectations. This section will explore a few of those issues and how the military responded.

First-Day and Second-Day Looting. Although some groups had warned in advance about the potential for civil unrest, including looting, the totality of the looting that occurred in Iraq surprised many coalition forces. XTF team members described two phases of looting by Iraqis, on the first night and on the second night. The first night, everything that was not bolted down or not too heavy to carry would be taken away. The second night, looters would return with the tools and transportation needed to take away anything left.

The looting was exacerbated by the fact that the simple presence of the U.S. military tended to attract attention. Once the forward units had moved on, Iraqis would then plunder the facilities.¹⁴⁹ The speed with which the looting took place was remarkable: SSTs that arrived quickly after an area had been cleaned out by ground forces encountered at least first-night looting at all but one site.

The extensive looting at many sites made it difficult to ascertain whether weapons, materials, critical computer files, or documents had been removed or destroyed. Much of the destruction, however, was not a byproduct of the looting, but rather was deliberate and purposeful. On one occasion at an Iraqi intelligence service's headquarters in Baghdad, MET A found Iraqis destroying materials even as U.S. forces were searching the area. One suspect had passports and false identification from three countries.¹⁵⁰ SST 3 found boxes of papers and computers neatly arranged in a stack and then burned at the Baghdad Research Complex.¹⁵¹

If stockpiles of chemical, biological, or nuclear material had been found, adequate forces would presumably have been assigned to that site. As one of the planners admitted, however, securing locations from theft had not been considered in advance.¹⁵² Another problem was the border, whose security was an issue before, during, and after the combat phase. If Iraq had had stockpiles of weapons, it is very possible that these

¹⁴⁷ Interview with a former operations officer from the 75th XTF, August 25, 2004.

¹⁴⁸ Much of the information in this section about actual operations was collected during interviews with former members of the 75th XTF conducted in May and August 2004.

¹⁴⁹ "A Few Leads in Weapons Hunt," CBS, May 12, 2003.

¹⁵⁰ Price, Owen, and Gonzales.

¹⁵¹ Barton Gellman, "Odyssey of Frustration—In Search for Weapons, Army Team Finds Vacuum Cleaners," *Washington Post*, May 18, 2003.

¹⁵² "A Few Leads in Weapons Hunt," CBS, May 12, 2003.

weapons could have been taken, either by regular citizens or members of the security apparatus and dispersed beyond Iraq to be sold on the black market.

The Drive to Baghdad. The scale of the looting turned another issue into a problem—the speed of maneuver. The original WMSL had nearly 600 sites, not accounting for ad hoc sites the teams expected to find on the way. Dr. David Kay said that “To do the first 40 sites, you’re talking at least a month and maybe longer, maybe six weeks.”¹⁵³ Meanwhile, the maneuver units were on pace to reach Baghdad in three weeks, the fastest advance in modern military history.

The first encounter at An Najaf revealed the inherent tension between careful exploitation and the combat plan. SST 4 spent four days at the 24-square-kilometer site, eventually sampling 21 bunkers. When those tests came back negative, the maneuver unit continued on toward Baghdad.

Other sites would be even larger, sometimes covering hundreds of acres. There was simply no way for a small team such as an SST to inspect such vast areas thoroughly within a few days. Nor were there any spare soldiers either to secure the sites or to remain behind to guard the SSTs. Then, as they neared Baghdad, CENTCOM began to increase the number of sites on the WMSL. The teams did their best to adapt, and by the end of May the SSTs were able to exploit up to four sites a day. One reason was simply the close proximity of the sites. Another was a change in standard operating procedure. The SSTs stopped treating each site as if it were “hot.” This meant they saved hours in preparation and redeployment. In fact, by the end of their time in Iraq, the teams were sometimes sending a single person, maybe with a Fox vehicle, to check a site off the WMSL.

Colonel McPhee was aware of these problems, and headquarters also adapted. Originally the sites were on a 96-hour planning cycle, but that was quickly changed to 24.¹⁵⁴ He noted that “as the maneuver units hit a target they had to move on, even 24 hours was too slow. By the time we got there, a lot of things were gone.” This was due to the underlying tension, which he described as:

You’ve got two corps commanders being told, “Get to Baghdad,” and, oh, by the way, “When you run across sensitive sites you have to secure them.” Do you secure all those sites, or do you get to Baghdad? You’ve got limited force structure and you’ve got 20 missions.¹⁵⁵

One of the SST commanders felt that they really needed to be attached forward with the battalions in order to get to the sites quickly enough to stay ahead of the

¹⁵³George Edmonson, “Inspections: Hunt for Banned Weapons Ongoing,” *The Atlanta Journal-Constitution*, April 15, 2003, p. 6A.

¹⁵⁴Gellman, “Frustrated, U.S. Arms Team to Leave Iraq.”

¹⁵⁵Gellman, “Frustrated, U.S. Arms Team to Leave Iraq.”

looters. This would not have entirely solved the problem. Even if they got there early enough, it is not clear they would have been able to stay. They would also have lost their civilian detachments, which either would have had to be protected by other maneuver units or remain at XTF headquarters.

Resource Constraints. Many of the issues were related to resource constraints. While resources are an issue in any campaign, some were major setbacks to the original planning. For example, the plan for the METs to be air-mobile fell apart almost immediately. Before combat operations even began, the aviation battalion assigned to the 75th XTF was double-tasked to support the media and CFLCC. For the entire operation, the METs would continue to have trouble securing adequate transportation, with MET A eventually resorting to commandeering vehicles from the 101st Airborne Division to move around Baghdad.

The number of U.S. troops in Iraq has been a major post-conflict issue, but the XTF felt the effect during the war. First, as noted above, the sites they were supposed to be exploiting were unsecured. There were not enough soldiers to guard the sites or to leave behind to protect the SSTs if they wanted to extend the survey. Second, the lack of linguists hurt many aspects of the mission. Each SST was supposed to have a linguist but never got them. This meant when an SST did reach one intact site, its members were unable to communicate with anyone there. Finally, despite the large number of people at XTF headquarters, there were not enough of the right people to staff additional SSTs. DTRA had the equipment for another team but not enough people. Eventually SST 5 was set up with personnel from Britain and linked with the marines.

The overall lack of equipment eventually affected the number of teams that the XTF was able to field. “Equipment shortages forced a permanent reduction in the number of weapons hunting teams from eight (3 [MET], 5 [SST]) to six (2 and 4 respectively).”¹⁵⁶ Then there were discrepancies between the civilian experts and the 75th XTF personnel in terms of personnel equipment, which did not help morale. For example, the DTRA people had the latest body armor, while the soldiers had Vietnam-era flak vests.

Communications were another issue. Although some of the reporters seemed to have equipment that enabled them to speak to their offices in the United States, the teams had trouble communicating with their own headquarters. Search teams had single-channel ground and airborne radio system (SINCGARS) and tactical satellite (TACSAT) radios, but at times the sensitivity of the intelligence required a more secure and reliable means of relaying information. On some occasions, even the TACSAT radios were unreliable or inadequate due to sensitivity and thus the teams were without communications.¹⁵⁷ As one member put it, it was often “like talking underwater.”

¹⁵⁶Price, Owen, and Gonzales.

¹⁵⁷Price, Owen, and Gonzales.

Comparatively, TF-20 could be launched within an hour's notice with secure communications from anywhere in Iraq. It also had full-time priority access to helicopters, allowing it to reach targets before they were looted.¹⁵⁸ While Special Forces have had more experience with SSE, it seems the primary difference in Iraq was their resource base.

Civilian Experts in a Combat Zone. The conventional forces were supposed to supplement their resource base with civilians. Although the Army has chemical officers, they usually do not possess the level of knowledge held by civilian experts, who often specialize in chemical, biological, or nuclear weapons. Nor did the military officers have the years of personnel experience and knowledge that the former UN inspectors possessed. Supplementing the SSTs, METs, and headquarters with experts was an attempt to solve this problem. It ultimately had limited success for several reasons.

First was that the weapons did not materialize. The nuclear experts in particular were little used. Second, the civilian experts were reluctant to go to any sites that were not fully secured. This was particularly frustrating to the soldiers of the 75th XTF who were more than willing and who were particularly motivated to get to sites before they had been completely looted. Third, there were huge deficiencies in other areas that would become more critical, especially linguists and human intelligence specialists. Fourth, security issues prevented coalition experts from fully contributing. One British expert who had been critically involved with the future operations group was denied access to the classified network.

Another civilian issue concerned the press. Although the Army generally considered the embedded reporter program a success, it was a problem for the XTF. First, most of the communication between the teams and headquarters was at a clearance level above that given to the reporters. The problem was that the teams were responsible for the reporters' safety, and in the field there was no way to isolate them from the communications. The situation became so untenable that eventually the team leader from MET A had to get direct permission from Major General Petraeus to change the rules.

The reporters also had a different motivation, which was to break the story as soon as possible. None of them wanted to wait for final results from the XTF labs or the labs in the United States. As it turned out, the many groups clustered together in the XTF were often reporting back to different superiors, which caused its own problem.

Finally, the most experienced civilians, the UN inspectors, were not involved in the process. After the ISG took over in June, the former chairman of UNSCOM, Rolf Ekeus, wrote an article that would have been useful six months earlier. He said,

Many hundreds of chemical engineers and production and process engineers worked to develop nerve agents, especially VX, with the primary task being to stabilize the warfare agents in order to optimize a lasting lethal property. Such work

¹⁵⁸ Barton Gellman, "Covert Unit Hunted for Iraqi Arms," *Washington Post*, June 13, 2003.

could be blended into ordinary civilian production facilities and activities, e.g., *for agricultural purposes, where batches of nerve agents could be produced during short interruptions of the production of ordinary chemicals.*¹⁵⁹

In hindsight it is unfortunate that the UN inspectors were not involved in preparations for the XTF, particularly with regard to what the teams should be looking for. The ISG was staffed with several former UN inspectors, including Dr. David Kay, its first special advisor.

Command and Control Issues. One purpose behind the XTF was to have a headquarters that could coordinate the operations, not only with the intelligence community but also with the maneuver commands. It was also to avoid a repeat of the problems encountered in Afghanistan. Although it appears that Colonel McPhee had a good working relationship with the CFLCC commander, the system did have some problems.

At the team level, a first lieutenant or a captain commanded the SSTs. A lieutenant colonel or a major, however, often led the DTRA and CBIST components. This caused problems in a number of cases where the DTRA people made it clear they did not like taking orders from someone of lower rank. As the focus of the operation changed, the specialists used this as a way to argue against changing their approach from detection to investigation. The METs seemed to have fewer issues with the command structure, but this may have been because they were not forward deployed and could be tailored with appropriate civilian experts for each mission.

At headquarters, there was a similar problem. Each team of specialists assigned to the 75th was led by a full colonel, which led to friction when it had to take orders from the colonel who commanded the 75th. Not only was there tension regarding rank and authority, but people also were reporting to different superiors in Washington. This further muddied the entire chain of command. It seems that the ISG did learn from this aspect of the operation, in that the commander of the ISG was a major general.

These issues extended out to the field and up the reporting chain. The field equipment of the chemical officers in the maneuver units, as well as on the Fox vehicles deployed with the SSTs, was very sensitive and often came up with a false positive. In several cases, this led to a maneuver unit making an announcement over open channels, causing a press frenzy. Once a more experienced SST or MET arrived and determined that the substance in question was not a chemical weapon, there would often be disputes over their assessment of the situation.

The distances involved in the mission also seemed to play a role. Due to transportation and communication problems, the teams were often somewhat cut off from headquarters. However, unlike a special operations team, they were not designed to operate independently. It is interesting to note that the SSTs felt that the marines were

¹⁵⁹ Rolf Ekeus, "Iraq's Real Weapons Threat," *Washington Post*, June 29, 2003, p. B7. Emphasis added.

much more flexible. The marines essentially told them to exploit whichever sites they thought were most important within the marines' area of responsibility. Eventually the METs were placed under operational control of the maneuver units, but this caused problems with coordination.

Finally, the SOF teams were another source of command and control problems. As mentioned above, TF-20 was also carrying out SSE operations in Iraq. The XTF teams often searched places that had already been covered by TF-20, once apparently arriving while TF-20 was still working. They became known as "secret squirrels" to the XTF.¹⁶⁰ This indicates a clear lack of coordination between CFLCC's targeting cell and SOF control elements within CENTCOM. While it may have made sense to use TF-20, especially given the resource constraints of the XTF, it doesn't make sense to then waste XTF resources on sites that had already been exploited.

Intelligence Failures. As has been noted elsewhere, including in the final ISG report, there was a massive intelligence failure regarding WMD in Iraq. This had a direct effect on the ground. Several SST and MET leaders expressed great frustration with the quality of the intelligence they received for the WMSL sites. The information in the site folders was often out of date and imagery sometimes dated back nearly a decade. In some cases, the buildings shown in the imagery no longer existed or had been damaged years earlier. Despite this, their instructions were often comically specific. They'd be directed to search a particular locker in a particular room, and if they did not find anything they were supposed to leave. The teams found themselves in extreme situations, either where the building did not even exist or in which they'd find something in the next room but were told to go on to the next site anyway. At one point they were sent to survey a suspected SAM site at Baghdad International Airport—weeks after U.S. forces had occupied it.

In October 2003, Admiral Edmund P. Giambastiani Jr. compiled a lessons learned report. In his testimony, the admiral said that the military's ability to collect human intelligence in Iraq, as opposed to intelligence gathered from intercepts of communication or from aerial or satellite photographs, was "seriously deficient" and must be improved.¹⁶¹

Given the poor quality of prewar intelligence, it was even more frustrating for the teams to continue to have to follow the WMSL and then the IMSL. It seems that by May, none of the teams had any confidence that the site lists would lead to anything of value. One team leader declared that the intelligence he received in the target folders told him nothing that he did not already know.

The XTF Versus the WMSL. By far the largest issue was that the mission the 75th XTF was designed and trained for did not materialize. The task force did not find stockpiles of WMD. The SSTs and METs seem to have concluded quite early in the

¹⁶⁰Gellman, "Covert Unit Hunted for Iraqi Arms."

¹⁶¹Robert Burns, "Review of Iraq War Finds Some Failures," *St. Petersburg Times*, October 2, 2003.

war that WMD were not present, which is perhaps not too surprising given the quality of intelligence they were given. This mismatch between mission planning and ground truth caused problems because the teams tried to adapt and change their mission. CENTCOM does not seem to have had a prepared alternative, known as a branch or sequel, and thus it seemed incapable of fundamentally changing direction and procedure during the middle of the campaign. When the stockpiles didn't surface, the only thing the military had to fall back on was prewar intelligence, primarily as defined by the WMSL.

As one team leader put it: "The job had three phases. First, find a smoking gun. Second, find evidence that they could make a smoking gun. Third, find evidence of their intention to make it." It was in the latter two phases that the military struggled.

Thus, as time went by with no WMD found, CENTCOM increasingly focused on going to every site on the list, no matter how low a priority. If no materials or weapons were found, the teams were to proceed immediately to the next site. One MET leader described the CFLCC approach as an "obsessive compulsive desire to check every site on the list" that got in the way of "focusing on actionable intelligence." An operations officer at XTF headquarters had a different perspective: "We didn't like sending our teams to places we felt were going to be dry holes. But half the drill for CFLCC was going to sites to show that nothing was there."

A further problem was that there seemed no way for CFLCC to adapt even when the teams did uncover actionable intelligence. For example, on May 22, MET B was following up a tip from a local Iraqi. He owned a house that had been used by three Iraqi scientists on the coalition's "top 55" list. Right before the war began, the three Iraqis removed several boxes, computers, and equipment items and left in several large sedans. Although he had previously been threatened to keep silent, he felt safe enough to approach the coalition.

MET B found a number of documents, containerized soil samples and several vials.¹⁶² MET B's commander also noticed that the house was out of place for the upper-income neighborhood, with only a single bed. The commander's assessment was that the house served as a tactical operations center. He wanted to do a thorough investigation of the house. In the commander's words, he wanted to search inside the walls. Although the team did take the soil samples and numerous documents, it was ordered to continue on to the next site scheduled for exploitation.

This was neither the first nor the last time in which local human intelligence (HUMINT) information would be overruled in favor of pursuing another WMSL target. It would prove to be increasingly frustrating for the teams as the intelligence upon which the WMSL was based continued to show itself inadequate and out of date.

It was understandable that the XTF commander had concerns over the direction the teams were taking in the field. It is interesting, however, that their adaptations were

¹⁶²Interviews with 75th Field Artillery Brigade.

adopted by the incoming ISG. For example, when briefing the media on his accession to the leadership of the ISG, Major General Dayton said that the group would have a decreased emphasis on the sites on the list, relying more on the intelligence information that its own component developed.¹⁶³

Observations and Lessons

The 75th XTF's mission in Iraq was unprecedented. This was the first time anyone had attempted a broad, coordinated search for WMD during combat operations. Before OIF, the SSE mission had largely been limited to small-scale special operations, such as in Afghanistan and the first Gulf War. To provide command and control for the mission in Iraq, CENTCOM and CFLCC planners created a dedicated special headquarters led by the headquarters element of the 75th Field Artillery brigade that controlled a number of small teams designed for SSE operations.

The experience was mixed. On the positive side, the effort that went into staffing, training, and developing the SSE concept should not be undervalued. The CENTCOM and CFLCC planners had very little time to create a working concept of operations, but they succeeded in coming up with a good approach based on the information they had. The 75th XTF, for its part, handled an unusual assignment, under severe constraints, very well. It inspected 337 sites with no injuries. It collected thousands of pages of documents and even assisted in detaining key Iraqi scientists. It showed how adaptable the Army could be when the need arose, and a surprising number of its suggestions and lessons were incorporated into the ISG.

On the negative side, the coalition's unquestioned assumption that there would be WMD stockpiles had significant repercussions. Because it did not have a backup plan, it was not able to quickly transform the mission in a strategic manner. CFLCC often resisted the XTF teams' attempts to adapt. As the final ISG report stated,

Wartime conditions prevailed with concern about force protection primary. The work of XTF-75 was therefore aimed at discovery of possible WMD locations (to eliminate a threat), not the compilation of evidence to build a picture of what happened to the weapons and programs. This early approach, perhaps logical if the goal was simply to find hidden weapons, undermined the subsequent approach of piecing together the evidence of the Iraqi WMD programs such as they existed. In fact, combined with the chaos of the war and the widespread looting in the immediate aftermath of the conflict, it resulted in the loss of a great amount of potentially very valuable information and material for constructing a full picture of Iraqi

¹⁶³David Anthony Denny, "New WMD Survey Group to Begin Operation in Iraq Soon," The Washington File, Bureau of International Information Programs, U.S. Department of State, May 30, 2003.

WMD capabilities. Sites were looted. Documents were either ignored or collected haphazardly or burned by either the Regime or Coalition forces.¹⁶⁴

The second biggest obstacle was the lack of resources. It is not clear, if the mission had focused on programs, whether sufficient linguists, HUMINT experts, transportation, and security forces would have been available at the time of the invasion. And even had the military anticipated the looting that took place, it is not clear that it could have been wholly contained. In addition to many more forces, containment would probably have required a political decision to impose martial law, arrest, and possibly even shoot Iraqi civilians.

The military also needed a clear process in place before the war for bringing in Iraqi scientists, debriefing them, and guaranteeing their safety. Despite DoD statements, this was not the case in Iraq.¹⁶⁵ As the ISG final report noted,

[There was a] lack of incentive for WMD program participants to speak with ISG investigators. On the one hand, those who cooperated risked retribution from former Regime supporters for appearing to assist the occupying power. On the other hand, there was substantial risk that the Coalition would incarcerate these individuals. Hence, for the most part, individuals related to Iraqi WMD tried to avoid being found. Even long after the war, many Iraqi scientists and engineers find little incentive to speak candidly about the WMD efforts of the previous Regime. This is exacerbated by their life-long experience of living with the threat of horrible punishment for speaking candidly.

Another problem was not including UN weapons inspectors and their expertise. While it is understandable that warplans are created under the most secret conditions, it is not clear that any attempt was even made to use the experience of UN inspectors. They may have been able to help set up a program to deal with the Iraqi scientists before the war. Dr. Kay attempted to do this when he began work with the ISG, saying that he “believed that if ISG were to find any WMD in Iraq, Iraqis would probably have to lead ISG to it.”

The final ISG report demonstrates why these issues should continue to be a priority for the U.S. military. ISG chemical weapons and counterterrorism experts uncovered and tracked down an active insurgent group that had been using former regime chemical weapons experts to attempt to create these weapons for use against the coali-

¹⁶⁴Iraq Survey Group, “Scope Note,” *Weapons of Mass Destruction (WMD): Iraq Survey Group Final Report*, Vol. I, GlobalSecurity.org, September 30, 2004.

¹⁶⁵David Albright, a former weapons inspector in Iraq and president of the Institute for Science and International Security, said that he was in contact with Iraqi scientists he knew throughout the war. They told him during the war that they were interested in cooperating with the Americans, but they quickly changed their minds when they saw colleagues arrested and others attacked by insurgents. (Interview with authors, April 7, 2004.)

tion. This was dubbed the Al Abud network after the location of the first raid where insurgents were found attempting to acquire ricin.¹⁶⁶

It is quite conceivable that SSE operations will have to be conducted during combat operations in the future. Depending on the scale of the operation, it may not be feasible to use only special operations forces. The U.S. military needs to determine, based on the experience of the XTF, the best way to prepare for such a contingency.

The concept of a headquarters to coordinate actions seems a good step forward. The issue is whether such a headquarters should be ad hoc, stood up from a regular Army combat support unit for each conflict that may require SSE, or whether it should be permanent, consisting of a small cadre of specialists and technical experts who plan and train for SSE missions all the time.

Given the increasing likelihood that future regional conflicts will feature countries with WMD, some sort of permanent SSE headquarters cell makes sense. A permanent cell would be able to establish working relationships with expert organizations such as DTRA, CBIST, the intelligence community, the Defense HUMINT Service, and SOF, as well as key allies likely to be involved in future operations. One lesson from the 75th XTF's experience in OIF is the importance of having a unit that understands maneuver support requirements, possesses robust communications, organic transportation, and logistics functions, and has the command structure capable of directing the METs. This suggests that the ideal unit to host an SSE headquarters would look very much like a combat support brigade. Since that may be too large a unit to dedicate full time to SSE operations, the solution may be to create a task force headquarters for SSE with a standing relationship to a combat support unit that can be dedicated to SSE missions when the need arises.

The 75th XTF did not find stockpiles of WMD, but to view the mission through that final result is to ignore everything it learned as well as the issues that the Army must still address for the future. Its experience will be invaluable for planners and operators the next time an SSE mission arises where WMD might be present.

Concluding Remarks

Decisionmakers want to know what OIF portends for the future of warfare. All such judgments must be hedged with the caveat that what worked against Saddam Hussein's regime might not work against another opponent. Due to his brutal and capricious leadership, the Iraqis were unprepared for the invasion and demoralized even before it began. Moreover, they seldom used their weapons effectively thanks to poor training and tangled command relationships. Ironically, the invasion was less dangerous and costly to U.S. forces than the subsequent occupation.

¹⁶⁶Iraq Survey Group. "Scope Note."

It is easy to discern what the invasion of Iraq did *not* portend for the future of warfare. It did not support arguments that U.S. forces need to be more rapidly deployable, because the United States dictated the pace of events and could take whatever time it needed. It did not suggest that U.S. forces should shift emphasis from close combat to stand-off fires. On the contrary, close combat was essential to flush enemy forces and to defeat them. It did not offer any glimpse into a future in which U.S. land forces could develop situations while still out of contact with the enemy. Indeed, enemy forces often went undetected before engagement, even in situations where they presented an optimal target to our collection assets. It certainly did not indicate that U.S. land forces could safely trade armor for some combination of situational awareness and firepower. Instead, it strongly suggested that heavily armored vehicles will be required for the foreseeable future.

The conflict also strongly suggested that the United States will need land forces ranging from small, light, special operations forces to large, heavy, armored and mechanized forces to accomplish all its missions. It also showed that integration of special operations forces and conventional forces is deficient and demands attention. It showed that urban combat will probably be unavoidable when the United States has to occupy a country and that it will require combined arms teams well supported by air forces. The preferred means of fire support will often be air-delivered ordnance that is both precise and devastating. The invasion showed that highly responsive airpower is a key advantage for land force commanders, but that the U.S. Army and Air Force must work harder to achieve the seamless integration envisioned in joint doctrine.

Air Operations

*Bruce R. Pirnie, John Gordon IV, Richard R. Brennan, Jr.,
Forrest E. Morgan, Alexander C. Hou, Chad Yost*

As in Operation DESERT STORM, Iraqi land forces were the primary focus of air attacks. Air planners largely ignored infrastructure because its destruction would work against the goal of a stable, democratic country. Iraq had no naval forces, and very few air forces were still operational. Iraq's air defense forces were in decline due to international sanctions and coalition air attacks conducted under Operations NORTHERN WATCH and SOUTHERN WATCH. Iraq was known to have short-range ballistic missiles and presumed to have some medium-range ballistic missiles, requiring a level of effort below that of DESERT STORM, during which Iraq had possessed a much larger and more capable missile force. In contrast to these other target sets, Iraqi land forces were ubiquitous and highly appropriate targets. They were the foundation of Saddam Hussein's power, and their destruction would reduce the risk of U.S. casualties on the march to Baghdad. Attacks against Iraqi land forces fell into two broad categories: air interdiction against Iraqi forces at some distance from U.S. forces, and close air support against Iraqi forces in contact with U.S. forces. Of these, close air support appears to have been the more effective. It was critical to the success of special operations forces in the western desert and northern Iraq. It was extremely helpful to the 3rd Infantry Division, advancing west of the Euphrates River, and the 1st Marine Division, advancing between the Tigris and Euphrates Rivers. Due to precision-guided munitions, close air support proved especially useful in urban terrain where the trajectory of artillery fire would have limited its utility.

After years of dueling during Operations NORTHERN WATCH and SOUTHERN WATCH, coalition air forces were well acquainted with Iraqi air defenses. Starting in June 2002, Operation SOUTHERN WATCH transitioned quietly into Operation SOUTHERN FOCUS, implying a more aggressive approach to Iraqi air defenses. SOUTHERN FOCUS was planned and executed to further degrade Iraqi air defenses and consolidate air superiority in the southern no-fly zone, setting conditions for operations to remove the Iraqi regime. Under SOUTHERN FOCUS, the list of permissible targets in response to Iraqi surface-to-air fires expanded to include such targets as long-range radars, critical communications nodes between Baghdad and areas in southern Iraq, headquarters south of the 33rd parallel, and known surface-to-surface

missile sites. By March 18, 2003, coalition pilots had flown 21,736 sorties as part of SOUTHERN FOCUS, ensuring air superiority south of the 33rd and enabling air forces to provide substantial support to maneuver forces from the start of Operation IRAQI FREEDOM.

Enemy land forces were significantly more difficult to attack during OIF. They were harder to locate and target because many were deployed in complex terrain, including the hills of northern Iraq and the myriad villages of the Tigris-Euphrates Valley, disrupting patterns of deployment and making the forces more difficult to find. In addition, OIF involved irregular forces. Most resistance came from these irregular forces, including Fedayeen Saddam, Al Quds militia, Ba'ath Party members, and foreign fighters who had little heavy equipment and deliberately hid in structures they presumed were on the coalition no-strike list, including hospitals, schools, and mosques. Unless on the move, such forces were almost impossible to target from the air unless observed by special operations forces or flushed by coalition forces advancing on the ground. Given good targeting data, interdiction is normally more advantageous than close air support, because it destroys enemy land forces before they can fire on friendly land forces. But in OIF there was seldom good targeting data on Fedayeen until they opened fire, and therefore close air support became the primary way to employ air power against them.

During OIF the coalition did not conduct extensive attacks on Iraq's infrastructure. Such attacks would have made little difference militarily while making it harder to revive and reform Iraq after the war. The United States knew that it would have to rebuild during the occupation what it destroyed during combat operations. It feared that Saddam Hussein would destroy his oil production capacity, perhaps by torching the wellheads. U.S. Central Command, therefore, planned how to preserve the oil fields. Indeed, the Marine Corps' first task in OIF was to secure the South Rumayyah complex.

From a wider perspective, the campaign in Iraq suggests that strategic attacks, i.e., attacks directed against an enemy's whole capability to wage war, are not very relevant to the post-Cold War environment. Strategic use of airpower is certainly not precluded. In some future war, airpower might strike again at an enemy's whole capability, as during the closing phase of the Vietnam War. But more frequently, air attacks will be directed against an enemy's military capability, which will quickly translate to his land forces. Moreover, in any campaign involving U.S. land forces, destroying enemy land forces saves U.S. lives, a particularly strong motive for such attacks. In addition, these campaigns demonstrate that air attacks are more effective when delivered in coordination with the actions of land forces. At a minimum, friendly land forces need to fix enemy land forces to make them good targets, which occurred in DESERT STORM. Fedayeen were a good example because they hid among civilians, sometimes even during combat. Against an enemy of this sort, the protracted bombing phase of DESERT STORM would have been completely ineffective.

Finally, precision weapons were widely used in OIF. Whereas in DESERT STORM roughly 6 percent of the air-delivered munitions were precision weapons (mostly laser-guided bombs), during OIF that number rose to about 68 percent. The increase in both the quantity and the variety of air-delivered precision munitions was noticeable.

Air Attacks

Substantially fewer combat aircraft deployed in OIF than in DESERT STORM. Whereas 1,800 combat aircraft from 12 countries were initially on hand for DESERT STORM, just under 790 fighters and bombers from the United States, the United Kingdom, and Australia were initially on hand for OIF. Roughly 90 percent of the combat aircraft deployed for OIF were American. The most numerous combat aircraft was the F/A-18 Hornet, flown by the U.S. Navy, the U.S. Marine Corps, and the Australian squadron that deployed for the operation. The fighters and bombers from the United States, the United Kingdom, and Australia that were initially on hand for OIF appear in Table 5.1.¹

The air forces in OIF (Table 5.1) flew missions in support of operational objectives that included gaining and maintaining air superiority, supporting land forces in operations to defeat the Iraqi Republican Guards and regular army, dismantling the regime's ability to command its forces and govern the state, supporting special operations forces in northern Iraq, and suppressing Iraqi ballistic missiles and other systems capable of delivering weapons of mass destruction. A similar number of sorties flown by tankers, surveillance and reconnaissance aircraft, electronic warfare, and other types of support aircraft enabled the operations of combat aircraft as well as those of other component forces.² Table 5.2 contains a breakout of sorties flown by aircraft type and contributing service or coalition partner.

The U.S. Air Force flew over 58 percent of all sorties in OIF. The Air Force contribution to aerial refueling capability was critical in enabling coalition air operations. Flying about two-thirds of the coalition's tanker sorties, Air Force tankers offloaded 90 percent of the fuel supplied through aerial refueling.³ Tankers from the Royal Air

¹ U.S. Department of Defense, *Conduct of the Persian Gulf War, Final Report to Congress*, Washington, D.C.: GPO, April 1992, pp. 85–86; Lieutenant General (USAF) T. Michael Moseley, Commander, U.S. CENTAF, Assessment and Analysis Division, "Operation IRAQI FREEDOM—By the Numbers," April 30, 2003, p. 7. Canada also contributed to the coalition air effort in OIF in the form of three airlifters, but did not deploy any combat aircraft.

² Moseley, "Operation IRAQI FREEDOM—By the Numbers," pp. 7–8.

³ Aerial tanking consumed 376,391,000 pounds of fuel. See Moseley, "Operation IRAQI FREEDOM—By the Numbers," p. 8.

Table 5.1
Combat Aircraft in Operation IRAQI FREEDOM

Service	Aircraft Type	Quantity
U.S. Air Force	A-10	60
	AC-130	8
	B-1	11
	B-2	4
	B-52	28
	F-117	12
	F-15C	42
	F-15E	48
	F-16	60
	F-16CJ	71
U.S. Navy	F-14	56
	F/A-18	176
U.S. Marine Corps	AV-8	70
	F/A-18	60
Royal Air Force	Harrier GR7	20
	Jaguar GR3	4
	Tornado F3	14
	Tornado GR4	30
Royal Australian Air Force	F/A-18	14

SOURCES: Lieutenant General (USAF) T. Michael Moseley, Commander, U.S. CENTAF, "Assessment and Analysis Division, Operation IRAQI FREEDOM—By the Numbers," April 30, 2003, p. 7; UK Ministry of Defence, *Operations in Iraq—First Reflections*, London: Ministry of Defence UK, July 2003, p. 47.

Force also made a valuable contribution, with 40 percent of their offloaded fuel going to U.S. Navy and Marine Corps aircraft.⁴

Operation SOUTHERN WATCH was directed largely against Iraqi air defenses. As a result, coalition air forces flew deep into Iraq from the outset of OIF without having first to suppress Iraqi air defenses. Iraqi air defenders were so weakened and demoralized that they did not attempt to complete radar-guided engagements. Coalition air forces suffered almost no damage from Iraqi air defenses so long as they stayed above low-altitude defenses, i.e., 5,000 feet above ground level. Damage occurred when pilots ventured lower, for example A-10 pilots during strafing runs. Attack helicopters

⁴ UK Ministry of Defence, *Operations in Iraq—Lessons for the Future*, London: Ministry of Defence UK, December 2003, p. 28. U.S. Navy and Marine Corps jet aircraft, like their NATO counterparts, use a hose reel and "basket" (receptacle for receiving the hose) refueling system. But Air Force jet aircraft refuel from tankers equipped with a "flying boom" (pipeline extended from the tanker) system. Air Force tankers can use either system, but few are able to switch from one system to the other during the same sortie. As a result, jet aircraft have to be mated with the appropriate tanker.

Table 5.2
Sorties Flown in Operation IRAQI FREEDOM

	USAF	USN	USMC	USA	RAF	RAAF	Coalition Total
Fighters	8,828	5,568	3,794		1,736	302	20,228
Bombers	505						505
Tankers	6,193	2,058	454		359		9,064
Airlift	7,413					263	7,676
Command and control (C2)	432	442	75		112		1,061
Intelligence, surveillance, and reconnaissance (ISR)	452	357	305	269	273		1,656
Rescue	191						191
Other	182	520	320		1		1,023
Service total	24,196	8,945	4,958	269	2,481	565	41,414

SOURCE: Moseley, "Operation IRAQI FREEDOM—By the Numbers," pp. 7–8.

NOTE: Values do not include SOF, Army rotary wing, and coalition sovereignty sorties.

had to fly within range of ground fire and therefore suffered extensive damage, but only one attack helicopter was shot down in enemy-held territory.

Many of the airfield attacks were directed not so much against Iraqi air forces, which had stopped flying, but against any aircraft that might deliver weapons of mass destruction, if the Iraqis had such weapons. Some of these attacks might therefore be construed as targeting Iraq's weapons of mass destruction, a different category. Fixed targets associated with land forces were insignificant during OIF. The category of leadership targets, including associated communications, entailed considerably greater effort during OIF because the latter was explicitly directed against Saddam Hussein's regime, which would not be allowed to survive the war. But even so, the United States hesitated to attack some targets, for example switching stations, out of concern for collateral damage.

Table 5.3 lists the number and percentage of attacks against the desired mean point of impact (DMPI) for a range of target categories.

Weapons of mass destruction were the ostensible *casus belli* for OIF, but this target received less effort than other target categories because, in part, of the devastation likely to result from bombing these sites. In 1991, Iraq had a large inventory of modified SCUD missiles that could reach Israel from the western desert. The effort to suppress these missiles absorbed many sorties, yet it was ultimately unsuccessful in preventing missile launches. Over a decade later, it was uncertain whether Iraq still had any missiles in this class, although the coalition had to assume that some existed. The United States knew little about Iraq's programs to develop weapons of mass destruction. In 1991, the United States grossly underestimated the scope and scale of Iraq programs, especially its nuclear programs, but in 2003 it erred in the other direction, crediting Iraq with capabilities that it had relinquished or allowed to fall into disuse.

Table 5.3
The Air Campaign in Operation IRAQI FREEDOM

Target Category	DMPIs	
	Number	Percent
Air and space supremacy	1,441	7.2
Counter-land fixed targets	234	1.1
Suppression of regime's ability to command	1,799	9.0
Ballistic missiles/weapons of mass destruction	832	4.2
Killbox interdiction/close air support	15,592	78.4
Total	19,898	99.9

SOURCE: Lieutenant General (USAF) T. Michael Moseley, Commander, U.S. CENTAF, Assessment and Analysis Division, "Operation IRAQI FREEDOM—By the Numbers."

NOTE: "By the Numbers" counts desired mean points of impact (DMPIs). A single target, especially a large target such as an airfield, may involve many desired mean points of impact.

Nonexistent programs yielded few good targets, resulting in a low percentage of sorties directed against these targets (4.2 percent).

The final category in Table 5.3, killbox interdiction and close air support, dominated the air campaign. Almost 80 percent of the attacks during OIF were directed against this target category. There was a compelling *prima facie* case for preferring this target category: Land forces were a foundation of Saddam Hussein's power. They were the only way he could hold Kuwait in 1991 and the ultimate guarantee of his survival. Indeed, Saddam Hussein survived DESERT STORM primarily because the United States stopped short of defeating his Republican Guards, which he had prudently withheld from Kuwait. In the aftermath of his defeat, the Republican Guards ruthlessly suppressed rebellion, especially among Shi'ites in the south. To topple Saddam Hussein during OIF implied defeating his land forces, especially the elite divisions ringing Baghdad. However, there was another inducement to concentrate on land forces: Targeting them generally caused the least collateral damage. For political and humanitarian reasons, the United States was anxious not to inflict unnecessary suffering on the Iraqi people, especially since the ultimate goal was their liberation.

During Operation DESERT STORM, the coalition had conducted heavier attacks on Iraqi infrastructure than during OIF. Even so, two-thirds of all strike sorties flown during DESERT STORM had been directed against Iraqi land forces. Infrastructure targets (lines of communication, military industry, telecommunications, and electrical power) had accounted for 8.7 percent of all strike sorties. Targets associated with air superiority (airfields, surface-to-air missile forces, and integrated air defenses) had accounted for 14 percent of all strike sorties. See Table 5.4.

Table 5.4
Sorties Flown Against Target Categories in Operation DESERT STORM

Target Category	Sorties	Percent
Iraqi ground forces	23,430	66.8
Airfields	2,990	8.5
Ballistic missiles	1,460	4.2
Surface-to-air missile forces	1,370	3.9
Lines of communication	1,170	3.3
Military industry	970	2.7
Nuclear, chemical, and biological targets	970	2.7
Integrated air defenses	630	1.6
Telecommunications, command and control	580	1.6
Oil	540	1.5
Naval targets	370	1.1
Electrical power	345	1.1
Leadership	260	1.0
Total	35,085	100.0

SOURCE: Eliot Cohen and Thomas A. Keaney, *Gulf War Air Power Survey*, Washington, D.C.: Department of Defense, 1993, p. 341.

Precision Strike Dominates the Air Campaign

Air attacks against enemy ground forces predominantly employed guided weapons. Overall, guided munitions accounted for two-thirds of the munitions expended against ground forces, roughly an order of magnitude increase compared to DESERT STORM. Laser-guided bombs and JDAMs together accounted for 84 percent of the guided munitions, or 56 percent of all munitions expended.

While few types of combat aircraft could employ precision-guided munitions in DESERT STORM, virtually every type of combat aircraft available to the coalition for OIF could deliver either a laser-guided or GPS-aided bomb. The F-14 Tomcat, for instance, did not originally have air-to-ground capability and only flew counter-air missions during DESERT STORM. But by the start of OIF, the Navy had transformed the F-14 into a strike fighter, equipped with Low Altitude Navigation and Targeting Infrared for Night (LANTIRN) pods and armed with laser-guided bombs and JDAMs.⁵ Moreover, many of its aircrews had become qualified as airborne forward air controllers. Similarly, Air Force B-1 and B-52 bombers had been fitted to employ JDAM-based precision strike capabilities. They had already proved their value in Afghanistan in Operation ENDURING FREEDOM, flying great distances and loitering for lengthy periods with a large number of precision-guided munitions available on call to support ground forces.

⁵ A team from Naval Air Systems Command modified the software used by F-14D aircraft while en route to theater to allow employment of JDAM.

Because Operation SOUTHERN WATCH/SOUTHERN FOCUS had degraded Iraqi air defenses over southern Iraq, the Combined Forces Air Component Commander (CFACC) was able to place considerable emphasis from the start on supporting maneuver forces through interdiction and close air support. Only 234 attacks on ground forces went against fixed targets (Table 5.3). The overwhelming number of attacks—a total of 15,592 DMPIs—were directed against mobile land forces. The second highest category was strategic regime targets, totaling only 1,799 attacks. Only 1,441 attacks were directed against counter-air targets such as airfields and air defenses.⁶

To attack fleeting targets of opportunity more efficiently, the CFACC and the commander of CENTCOM developed a special process for such targets, which needed to be engaged rapidly. Three target types were identified as “time-sensitive targets” (TSTs) to be handled using this special process. TSTs included leadership, WMD-related targets, and terrorists. Recognizing that such a process could be useful for other kinds of fleeting targets, the CFACC used the same process for other highly mobile targets of opportunity, termed *dynamic targets*. In all, 156 TSTs and 686 dynamic targets were attacked during OIF. TST and dynamic target missions were executed with a combination of aircraft re-rolled from other missions and aircraft orbiting in designated airspace on call.⁷

Data on the types and quantities of weapons employed by coalition air forces in attacks on Iraqi fielded forces, time-sensitive targets, and other targets are shown in Table 5.5. Approximately 68 percent of all munitions released had some form of guidance. Laser-guided bombs stood out, accounting for around 43 percent of the guided munitions expended in OIF. More 500-pound GBU-12s were employed in OIF than any other munition, guided or unguided. JDAMs were also used in large quantities, accounting for about one-third of all guided weapons released during the operation. The 2,000-pound GBU-31 was the most commonly employed variant of JDAM and the second most employed guided weapon. Given the very large proportion of attacks directed against Iraqi fielded forces, it is interesting to note the number of AGM-65 Maverick missiles expended during the war. In DESERT STORM the Maverick was the most employed guided weapon and was credited with playing a large role in the destruction of Iraqi ground forces in that conflict.⁸ But in OIF, Maverick was only the fourth most employed guided weapon, behind the GBU-12, GBU-31, and GBU-16. While this result can be attributed in part to the deployment of fewer A-10s for OIF, the main reason was likely the marked increase in the numbers of platforms capable of employing either laser-guided bombs or JDAMs.

⁶ Moseley, “Operation IRAQI FREEDOM—By the Numbers,” p. 6.

⁷ Moseley, “Operation IRAQI FREEDOM—By the Numbers,” p. 9.

⁸ A total of 5,296 AGM-65 Maverick missiles and 4,493 GBU-12 laser-guided bombs were employed during DESERT STORM. A-10s fired the vast majority of Mavericks in this conflict. See discussion and Table 3 from the *Gulf War Air Power Survey*, pp. 102–103.

Table 5.5
Munitions Expended by Type

Guided Munitions		Unguided Munitions	
BGM-109 TLAM	802	M117	1,625
AGM-114 Hellfire	502	Mk82	5,504
AGM-130	4	Mk83	1,692
AGM-154 JSOW	253	Mk84	6
AGM-65 Maverick	918	CBU-87, CEM	118
AGM-84 SLAM(ER)	3	CBU-99, Rockeye	182
AGM-86C/D CALCM	153	UK unguided	124
AGM-88 HARM	408	Total unguided	9,251
CBU-103 WCMD, CEM	818		
CBU-105 WCMD, SFW	88	Rounds of ammunition	
CBU-107 WCMD	2	20MM	16,901
EGBU-27 GPS/LGB	98	30MM	311,597
GBU-10 LGB	236		
GBU-12 LGB	7,114	Leaflet Dispensers	
GBU-16 LGB	1,233	PDU-5	44
GBU-24 LGB	23	M129	304
GBU-27 LGB	11		
GBU-28 LGB	1		
GBU-31 JDAM	5,086		
GBU-32 JDAM	768		
GBU-35 JDAM	675		
GBU-37 JDAM	13		
UK guided	679		
Total guided	19,948		

SOURCE: Moseley, "Operation IRAQI FREEDOM—By the Numbers," p. 11.

The British Royal Air Force had made a substantial leap in its precision strike capabilities since the Kosovo campaign in 1999. In Operation ALLIED FORCE, only 25 percent of the weapons expended by the Royal Air Force were precision guided. In OIF, precision-guided munitions accounted for around 85 percent of its expended munitions. The Enhanced Paveway II precision-guided bomb, which can be employed with either laser guidance or internal navigation system/GPS guidance, was the most used guided weapon, accounting for around 50 percent of the guided weapons expended by the Royal Air Force. The laser-guided Paveway II was the second most expended guided weapon, accounting for 34 percent of the guided weapons expended by the Royal Air Force.⁹

⁹ UK Ministry of Defence, *Operations in Iraq—Lessons for the Future*, pp. 29, 86.

Air Attacks on Iraqi Ground Forces

Throughout major combat operations, air attacks contributed to the success of friendly land forces. These air attacks were largely directed against Republican Guards and regular army forces, although some were also directed against the more elusive Fedayeen Saddam and other militias. Air attacks were intended to achieve these operational objectives:

- Facilitate advance of the 3rd Infantry Division and the 1st Marine Division.
- Protect the eastern flank of 1st Marine Expeditionary Force.
- Destroy the Republican Guards divisions defending Baghdad.
- Fix Iraqi forces in northern Iraq along the “Green Line.”

Killbox interdiction and close air support (KI/CAS) was the central concept for employment of coalition air forces against Iraqi ground forces. Eighty percent of air attacks were classified as KI/CAS in support of the Combined Forces Land Component Commander (CFLCC) and the Combined Forces Special Operations Component Commander (CFSOCC) during OIF.¹⁰ Anticipating a fluid, unpredictable battlefield, the KI/CAS concept used “killboxes” to focus air attacks and to coordinate them with maneuver and other fires. Developed by CENTCOM as a common language for the coordination, deconfliction, and synchronization of joint fires, the Killbox Grid Reference System was defined by drawing lines parallel to lines of latitude and longitude spaced at intervals of 30 minutes latitude by 30 minutes longitude or approximately 30 nautical miles on a side. Each killbox was further subdivided into nine “keypads” spanning 10 minutes of latitude and 10 minutes of longitude—approximately 10 km on a side. These keypads were numbered from one to nine with a layout identical to that of a standard telephone keypad, as depicted in Figure 5.1.¹¹

An aircraft operating in a closed killbox was permitted to engage ground targets only when cleared by a terminal air controller on the ground or an airborne forward air controller. An aircraft operating in an open killbox was permitted to attack without terminal control. During OIF, killboxes short of the fire support coordination line (FSCL) were considered closed unless opened by a ground commander. Killboxes beyond the FSCL were considered open unless closed by a ground commander.

The developers of the KI/CAS concept of operations believed that reconnaissance would be required to find the intended target sets. As a result, the killbox interdiction mission was defined to be a combination of armed reconnaissance and air interdiction flown against nonfixed targets. The developers also created a strike coordination and

¹⁰ Moseley, “Operation IRAQI FREEDOM—By the Numbers,” p. 5.

¹¹ The killbox concept was not entirely new. Killboxes were also used in DESERT STORM but were only subdivided into quadrants instead of the nine keypads in OIF. See Thomas A. Keaney and Eliot A. Cohen, *Gulf War Air Power Survey, Summary Report*, Washington D.C., Government Printing Office, 1993, p. 52. A more detailed discussion of killboxes is included under the section below entitled “Control Measures.”

Figure 5.1
Killbox Concept

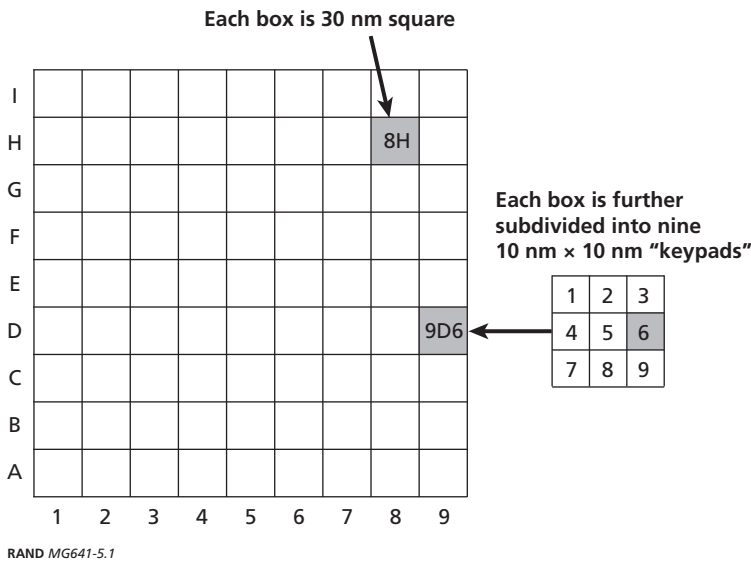

reconnaissance (SCAR) mission in order to help deal with a rapidly changing battlespace where prebriefed interdiction missions could be ineffective. Intended to serve as hunters in hunter-killer teams, SCAR aircraft could be sent to a specific killbox or avenue of approach to search for high-priority targets before other aircraft were committed. If targets were located and attack aircraft were committed, SCAR aircraft would coordinate and deconflict attacks on these targets while also contributing to their destruction.¹²

Regional Air Campaigns

There were three distinct air efforts in support of OIF:

- Support of V Corps and 1st Marine Expeditionary Force in the Tigris-Euphrates Valley.
- Support of special operations forces and Kurdish fighters on the "Green Line" in northern Iraq.
- In conjunction with special operations forces, suppress surface-to-surface missiles in western Iraq.

In the northern sector, the main objective was to fix and deplete the 11 Iraqi regular army divisions deployed along the "Green Line" against Kurdish peshmerga fight-

¹² Combined Forces Air Component Commander (CFACC), 2003, p. 22.

ers. Turkey's refusal to allow basing and overflight constrained air operations in the north during the early days of the war. Even after Turkey allowed use of its airspace, air support in the north was limited primarily to Navy aircraft based on the USS *Harry S. Truman* and USS *Theodore Roosevelt* in the eastern Mediterranean and B-52 bombers flying out of Fairford in the United Kingdom. Air operations in the north strongly resembled the air operations conducted during Operation ENDURING FREEDOM in Afghanistan. In the north, naval aviation and bombers supported special operations forces working with peshmerga fighters who faced Iraqi divisions in static positions and Ansar al-Islam terrorists. Similarly, naval aviation and bombers had supported Northern Alliance fighters who faced dug-in Taliban forces and al Qaeda terrorists.

The Tigris-Euphrates Valley was the central focus of air operations in support of ground forces. The primary targets were fielded forces of the Republican Guards and regular army. The operational objectives were to facilitate the advance of the 3rd Infantry Division and 1st Marine Division, to protect the Marine Corps' eastern flank especially from attacks by the Iraqi III Corps, to destroy the Baghdad Division in the Al Kut area, and to destroy the Republican Guards divisions defending Baghdad, especially the Medina Division and the Hammurabi Division.

Air provided critical support to ground forces during the sandstorm fight near An Najaf. From the perspective of the soldiers in the 3-7 Cavalry, the fight appeared to be one long ambush, with swarms of Fedayeen attacking in waves from all sides. At times the limited visibility allowed the Iraqis to approach within a few feet before they could be identified. The fighting, as a result, was very close and intense. Artillery fires were called onto targets that were in close proximity to friendly forces. Support from Kiowa Warriors or Apaches was not available because of the weather.

Fixed-wing aircraft continued to provide close air support throughout the sandstorm and remained effective. JDAMs became the weapon of choice, since the weather conditions generally precluded the use of laser-guided bombs. During an intense span of fighting on March 25, F-16s and F/A-18s under the direction of terminal air controllers with 3-7 Cavalry dropped 28 GBU-32 and GBU-35 JDAMs near troops in contact with the enemy.¹³ Later that day a group of Iraqi vehicles including some T-72s were detected advancing along a secondary road toward the position of *Crazy Horse* Troop of the 3-7 Cavalry. A terminal attack controller mapped out several coordinates along the highway to create strings of aimpoints for a B-1B bomber. The B-1B made three bombing runs, dropping its full load of 24 GBU-31 JDAMs along the highway.¹⁴ The Battle of An Najaf was the only fight during OIF in which bombers would drop weapons under the control of terminal attack controllers assigned to the 3rd Infantry Division.

¹³ 15th Air Support Operations Squadron, "3rd ID CAS BDA Results," spreadsheet, Fort Stewart, Georgia, undated; not available to the general public.

¹⁴ Technical Sergeant Michael L. Keehan, Tactical Air Control Party, 3-7th Cavalry, 3rd Infantry Division (Mechanized), *After Action Report*, undated.

While the sandstorm had taken away some of the advantages normally enjoyed by U.S. forces, the 3-7 Cavalry still prevailed thanks to the tenacity of its soldiers, fire support from artillery, and close air support from fixed-wing aircraft.

The main objectives for the air component in the western desert were to deny the Iraqis the ability to threaten Israel and Jordan with ballistic missiles, in partnership with special operations forces on the ground, and to provide support to those forces when needed. Air attacks were instrumental in supporting special operations forces as they seized airfields and other key facilities including the Hadithah Dam. U.S. forces secured the dam to prevent the Iraqis from inundating the Euphrates Valley to hinder the advance of coalition forces.

The Joint Tactical Information Distribution System (JTIDS)

While significant advances were made in the operational use of data links during OIF, much of its potential remained unexploited. During the war, data on aircraft position, call sign, aircraft type, weapons load, fuel status, frequency, tasking status, phase of flight, and weapons release for all JTIDS-equipped aircraft were available in the Combined Air Operations Center (CAOC). This kind of information would have been very useful on the operations floor and was in short supply. Unfortunately, only a trained operator in the Joint Interface Control Officer cell of the CAOC could extract the information using a specialized tool. As a result, it remained an untapped resource during the war. Minor modifications would have allowed this information to be made available for broader use in managing the air campaign.¹⁵

Other minor changes would have brought even more useful JTIDS data into the CAOC. A JTIDS-equipped fighter that designates a ground target can broadcast a data message containing the latitude, longitude, and elevation of the designation. Another message is transmitted whenever a weapon is released. Data of this type are normally only available to other JTIDS-equipped fighters. Minor modifications would have allowed the CAOC to tap into this fighter-to-fighter data stream. Such a capability exists at Nellis Air Force Base, but it did not exist in the CAOC at Prince Sultan Air Base.¹⁶ While this information would only have been available from JTIDS-equipped aircraft such as F-15Es, it would have given commanders in the CAOC (and elsewhere if disseminated) valuable feedback on the killbox interdiction and close air support operations.

Marine Corps Air

Marine Corps planners concluded an informal agreement with the CFACC before the start of the war. According to this agreement, the CFACC had theater airspace control authority, but the Marine Air Command and Control System would be used to control

¹⁵ Lieutenant Colonel (USAF) Brett Plentl, "Implementing the Net-Centric CAF," briefing, August 14, 2003.

¹⁶ Plentl.

aircraft supporting the 1st Marine Expeditionary Force. The 1st Marine Expeditionary Force developed a direct support air tasking order (ATO) for tasking Marine Corps aircraft that was included in the theater ATO developed by the CFACC. The Marine Corps offered some sorties to the CFACC for deep strikes, and in return the CFACC offered some sorties to the Marine Corps for interdiction and close air support.¹⁷

Several other factors tended to draw aircraft into the Marine Corps' area of operations. Shortly after the start of the campaign, the Marine Corps opened killboxes along their eastern flank, giving aircrews freedom to seek and engage targets of opportunity in this area where units of the Iraqi III and IV Corps were located. Aircrews also reportedly preferred working with the Marine Corps' Direct Air Support Center rather than the V Corps' Air Support Operations Center (see the next section for details).¹⁸ Moreover, these Iraqi units along the eastern flank and the Baghdad Division in the vicinity of Al Kut were within the nonrefueled range of many coalition strike aircraft operating from Kuwait and the Arabian Gulf.¹⁹ Consequently, aircraft could attack these targets without making demands on scarce tankers. As a result, the Baghdad Division and the 10th Armored Division on the Marine Corps' eastern flank received almost continuous attention from Marine Corps and other coalition strike aircraft.²⁰

Control Measures

Overall, coordination was successful. Supporting fires were usually well integrated and employed in ways that maximized coalition forces' freedom of maneuver. There were few incidents of fratricide. However, conflicting interpretations of draft directives and supplementary procedures hindered the effective employment of air power short of the fire support coordination line (FSCL) in the area controlled by V Corps.²¹ Inflexible and unresponsive command and control mechanisms, interoperability problems in information systems, and other equipment shortfalls added to this problem. As the war progressed, battle managers modified some fire support coordination measures and developed additional procedures for coordinating fires during an anticipated battle in Baghdad. These refinements mitigated some of the earlier problems.

¹⁷ See ENDURING FREEDOM Combat Assessment Team, "Initial Observations Report, Operation IRAQI FREEDOM: Command and Control of Aircraft and Missiles," Quantico, Virginia: Commandant of the Marine Corps, November 2003, pp. 1–2; Rebecca Grant, "Marine Air in the Mainstream," *Air Force Magazine*, June 2004, pp. 60–64.

¹⁸ The ASOC consisted of the Air Force's 4th Air Support Operations Group.

¹⁹ 1st Marine Division, *After Action Report*, p. 42.

²⁰ General John F. Kelly, "Tikrit, South to Babylon," *Marine Corps Gazette*, February 2004.

²¹ *Operation Iraqi Freedom: Third Infantry Division (Mechanized), "Rock of the Marne" After Action Report*, Final Draft, May 12, 2003.

The Fire Support Coordination Line (FSCL)

During planning, the CFLCC was concerned that fire support coordination measures keep pace with the anticipated rapid advance. During a rapid advance, coalition forces were liable to overrun the FSCL and thus expose themselves to friendly air attack. Moreover, bypassing Iraqi forces would leave them in the rear area, making it more difficult for pilots to distinguish friendly ground forces from enemy units. To prevent this situation, CFLCC placed the FSCL unusually deep at G-day. To meet these challenges, component commanders adopted a new version of Joint Publication 3-09.3, *Joint Tactics, Techniques, and Procedures for Coordinating Close Air Support (CAS)*, while it was still in draft. Additionally, the CFACC and 1st Marine Expeditionary Force developed supplementary fire support coordination measures.

To reduce the risk of fratricide as a result of coalition forces overrunning the FSCL, the CFLCC placed the line approximately 140 kilometers beyond the forward line of friendly forces on G-day and moved the FSCL forward from phase line to phase line as friendly forces advanced. The V Corps Air Support Operations Center (ASOC) would be responsible for coordinating air attacks short of the FSCL, and close air support sorties would be put under positive control of tactical air control parties and enlisted terminal air controllers, i.e., they would be directed to targets and cleared to fire by ground controllers and integrated with other fires through the 3rd Infantry Division tactical command post.²²

The 1st Marine Expeditionary Force persuaded the CFLCC to allow it to set a FSCL in its area of operations that was not as deep as the one used by the V Corps. The 1st Marine Expeditionary Force also employed a battlefield coordination line (BCL) approximately 30 kilometers in front of its own lead element to distinguish between fires requiring positive control from those that did not. Coordinating with the CFACC and the CFLCC, the 1st Marine Expeditionary Force moved the BCL to keep pace with advance in its area. Sometimes the BCL was defined by phase lines and sometimes by killbox and keypads.

Killboxes

The killbox concept, described earlier, called for killboxes that contained friendly forces to be “closed,” implying that positive control by a terminal air controller was required for release of ordnance. Killboxes that did not contain friendly forces would be “open,” implying that positive control was not required. Killboxes short of the FSCL would be closed, unless opened by V Corps or 1st Marine Expeditionary Force in their respective areas of operation. Killboxes beyond the FSCL would be considered open unless closed by a ground commander.

²² 3rd Infantry Division (Mechanized), pp. 106–109. Also see CAOC, “Operation IRAQI FREEDOM CAOC-PSAB Offensive Ops Team Lessons Learned,” draft v8, April 29, 2003, p. 22.

When employed properly, the killbox/keypad system worked well, but it too had flaws. Fire support coordinators found the killboxes too large. When a killbox was open, surface-to-surface fires had to be deconflicted, thus slowing artillery fire response times. Forward air controllers frequently used killbox corners as geographic references for directing close air support, but due to the large size of killboxes, the initial reference points published in the air tasking order (ATO) were too few to deconflict aircraft routes with surface fires and too widely separated for adequate controller-to-aircraft interaction, given the limits of UHF communications. Officers in the V Corps area of operations also complained that opening and closing killboxes took too long. In contrast, Marine Corps controllers noted how quickly boxes were opened and closed in the 1st Marine Expeditionary Force area of operations.²³

The Marine Corps's Direct Air Support Center (DASC)

The 1st Marine Expeditionary Force Tactical Air Operations Center (TAOC) managed the airspace in the Marine Corps area of operations, and Direct Air Support Centers supported the 1st Marine Division, Task Force Tarawa, and the UK 1 Armoured Division. DASCs integrated close air support with mortar, artillery, and rocket fires short of the BCL. The 3rd Marine Air Wing established close battle cells in its TAOC to help coordinate close air support for each of the three major ground units within the 1st Marine Expeditionary Force area of operations. It dedicated four KC-130 aircraft to provide an airborne DASC to control rotary-wing sorties 24 hours a day, 7 days a week. For deep shaping operations, the Marine Corps “used the TAOC in a non-doctrinal manner” to control aircraft engaging targets beyond the BCL but short of the FSCL.²⁴

Coordination of Joint Fires

3rd Infantry Division Supporting Fires

Joint fires were well integrated and responsive in support of the 3rd Infantry Division. Coordination between fire support elements, the Division Tactical Command Post, tactical air control parties, and enlisted terminal air controllers went smoothly. The CFACC apportioned many sorties to close air support, and the ASOC provided “push

²³ 1st Marine Division, “Operation Iraqi Freedom (OIF) Lessons Learned,” May 29, 2003, p. 25; 3rd Infantry Division (Mechanized), pp. 32 and 109; interview with 3rd Infantry Division, 2003; interview with Marine Corps Combat Development Command, 2004.

²⁴ ENDURING FREEDOM Combat Assessment Team, “Initial Observations Report, Operation IRAQI FREEDOM: Command and Control of Aircraft and Missiles,” pp. 4–5. The Tactical Air Operations Center’s doctrinal responsibilities include airspace management and air defense, but do not ordinarily include controlling air-to-ground fires. See U.S. Marine Corps, MCWP 3-25.3, *Marine Air Command and Control System Handbook*, Washington, D.C.: GPO, December 2, 1997, and U.S. Marine Corps, MCWP 3-25.4, *Marine Tactical Air Command Center Handbook*, Washington, D.C.: GPO, September 21, 1998.

CAS” to support division requirements. Air liaison officers positioned aircraft “stacks” to make air support to troops in contact available within 5–15 minutes, with occasional delays due to weather.²⁵

Because of shorter response times, field artillery dominated the counter-fire fight. Fire coordinators also used close air support for counter-fire if it was in the area, but the times required for pilots to search for targets and perform positive identification usually made close air support a less effective counter-fire option. Different rules of engagement exacerbated this problem: Army procedures permitted the use of Q-36/Q-37 counter-fire radars for positive identification of enemy artillery positions, but the Air Force Special Instructions to Pilots did not authorize them to accept counter-fire radar returns as positive identification.²⁶ Use of counter-fire radar for positive identification would have made close air support more responsive, because Q-36/Q-37 radars produce a ten-digit grid (target location to one-meter accuracy) suitable for targeting JDAMs.²⁷

V Corps Supporting Fires

Supporting fires were not as well coordinated for shaping in the V Corps area of operations. Placing the FSCL 140 kilometers beyond friendly troops reduced the risk of fratricide in the rapid advance, but created an area too large for the ASOC and Fire Effects Coordination Center to effectively manage.²⁸ This problem was confounded by the lack of a specified division forward boundary. Since the CFLCC did not designate a division forward boundary in the first days of the conflict, confusion arose regarding whether the ASOC or the Division Tactical Command Post was responsible for coordinating close shaping operations. The V Corps and the CFACC repeatedly engaged targets in the 3rd Infantry Division’s area of operations without consulting the division. This confusion increased the risk of fratricide and may have contributed to an incident in which an F-15E mistook a Multiple Launch Rocket System (MLRS) for an enemy surface-to-surface missile unit and fired upon it, causing nine casualties.²⁹

Other problems hindered deep shaping operations. Based on the CAOC’s interpretation of the draft Joint Publication 3-09.3 and the killbox/close air support concept, the CFACC expected the ASOC to open killboxes for air interdiction in areas

²⁵ Interview with 15th Air Support Operations Squadron, October 28, 2003.

²⁶ The Special Instructions to Pilots or “SPINS” is a handbook intended to provide pilots and controllers abbreviated guidance on mission, communications procedures, threats, rules of engagement, personnel recovery procedures, etc.

²⁷ 3rd Infantry Division (Mechanized), pp. 29–33; interview with 3rd Infantry Division, October 28–29, 2003; interview with 15th Air Support Operations Squadron, October 28, 2003. According to 3rd Infantry Division artillery officers, while Air Force pilots could not use counter-fire radar returns for positive identification, Marine Corps pilots “would drop on anything.”

²⁸ 3rd Infantry Division (Mechanized), pp. 106–108.

²⁹ 3rd Infantry Division (Mechanized), pp. 140–141.

where coalition forces were not present. But the ASOC, following CFLCC and V Corps guidance, interpreted the draft directive to mean that all air operations short of the FSCL would be “Type 3 CAS” requiring positive control, and thus it resisted opening killboxes in that area. Moreover, until the FSCL became static at phase line New York, the ASOC required all air sorties in the V Corps area of operations to be under positive control of a ground terminal air controller. Aircraft with forward air control-qualified crews were considered strike assets only and not permitted to perform terminal control or strike coordination and reconnaissance functions.³⁰ These impediments had significant impacts. Having insisted that all strike sorties be placed under positive ground control, the ASOC and tactical air control parties were quickly overwhelmed with calls from aircraft and unable to coordinate and control attacks for such a vast area. Consequently, many aircraft orbiting in CAS stacks exhausted their fuel awaiting targets and returned to base with unexpended munitions. More seriously, shaping operations were hindered and the enemy was provided a degree of sanctuary short of the FSCL.³¹

Poor placement, sizing, and movement of position area hazards for Army Tactical Missile Systems caused difficulty in the V Corps area of operations. During planning, V Corps established a number of very large position area hazards with 60,000-foot ceilings and put them in constant effect, creating large restricted-operations zones that made it difficult for other forces to plan air routes and find suitable locations for forward air refueling points. When field commanders criticized this approach, the V Corps first responded by moving the position area hazards to the periphery of the 3rd Infantry Division’s zone of action, easing the airspace coordination problem but exposing the lightly defended missile units to the possibility of enemy attack.³² As the battle progressed, V Corps reduced position area hazard size from 16 kilometers on a side to 7 kilometers and finally to 3 by 3 kilometers as recommended in Army doctrine. However, whenever Army Tactical Missile Systems were prepared to fire, air controllers had to clear 20-mile-wide “shooting lanes” and pull aircraft out, even if they were supporting troops in contact.³³ The V Corps repeatedly moved position area hazards with little advance notice, generating significant airspace management and fire coordination challenges for tactical operations centers and fire support elements that had insufficient time to fully analyze the impacts.³⁴

³⁰ CAOC, pp. 22–23.

³¹ Interview with 3rd Infantry Division, 2003.

³² 3rd Infantry Division (Mechanized), pp. 109–110.

³³ Interview with 15th Air Support Operations Squadron, October 2003.

³⁴ 3rd Infantry Division (Mechanized), p. 261.

I MEF Supporting Fires

Joint fires were better coordinated throughout the 1st Marine Expeditionary Force battlespace. Much of this success can be attributed to the rapport Marine Corps commanders and liaisons established with their Air Force counterparts in extensive interaction before the conflict. Marine Corps representatives helped develop the killbox interdiction/close air support concept, embraced its philosophy, and integrated its procedures with 1st Marine Expeditionary Force's own supplementary fire support coordination measures.³⁵ This approach enabled the Marine Expeditionary Force to establish a permissive fire support environment while keeping the risk of fratricide low. Additionally, before the start of operations, close integration was established between 1st Marine Division and the 3rd Marine Air Wing (MAW). Planners from 3rd MAW were included in the division's planning sessions and linkages were established between the Regiment Combat Teams (RCTs) and fighter squadrons in the MAW.³⁶

Marine Corps controllers integrated joint fires effectively in both the close battle and shaping operations. Upon entering Marine Corps airspace, pilots checked in with the TAOC, where controllers updated them on current BCL location and killbox status, cleared them for their missions assigned by the ATO, and turned them over to a DASC for assignment to a forward air controller, or directed them to a CAS stack.³⁷ The DASCs worked closely with Ground Fire Support Coordination Centers and the TAOC to integrate supporting fires. These centers opened and closed killboxes within minutes of receiving requests from ground commanders.³⁸ Pilots usually received CAS targets expeditiously. Marine Corps forward air controllers operated from the most forward unit, often from tank turrets. Most were highly skilled in directing pilots onto targets; however, Air Force and Marine Corps pilots complained that some Marine controllers abbreviated target information reports and were too eager to "clear hot" without assuring adequate positive identification.³⁹ Marines used forward air controllers airborne in fixed- and rotary-winged aircraft whenever possible. If CAS targets were not readily available, the DASCs frequently referred sorties back to the TAOC, where

³⁵ ENDURING FREEDOM Combat Assessment Team, "Initial Observations Report, Operation IRAQI FREEDOM: Command and Control of Aircraft and Missiles," pp. 1–2; 1st Marine Division, *After Action Report*, Chapter 3, pp. 5–6; interview with Marine Corps Combat Development Command, Marine Base Quantico, Virginia, March 30, 2004. One Marine Corps planner described his extensive involvement in monthly air planning meetings at Headquarters, 9th Air Force, in 2002 and stated that, though they were invited, neither CFLCC nor V Corps sent representatives to those meetings.

³⁶ Interviews with 1st Marine Division and 3rd MAW, Camp Pendleton, California, October 1–3, 2003.

³⁷ CAOC, p. 25; interview with Marine Corps Combat Development Command, 2004.

³⁸ ENDURING FREEDOM Combat Assessment Team, "Initial Observations Report, Operation IRAQI FREEDOM: Command and Control of Aircraft and Missiles," p. 4.

³⁹ CAOC, p. 40; "MAWTS-1 Lessons Learned (MAWTS-1 LL)," *Marine Aviation Weapons and Tactics Squadron Lessons Learned Report*, April 2003, pp. 1–2.

controllers assigned them interdiction targets.⁴⁰ Since the 1st Marine Expeditionary Force shared the CFACC's interpretation of the draft Joint Publication 3-09.3 and killbox interdiction/CAS concept of operations, the TAOC opened killboxes between the BCL and FSCL, creating a permissive environment for air interdiction. The TAOC also encouraged aircrews, after expending munitions, to loiter in the area and perform strike coordination and reconnaissance, fuel permitting.

The DASC Versus the ASOC

Some aircrews began looking for ways to be released from the V Corps CAS stacks and placed under control of "the DASC." Some pilots played "ASOC Joker," i.e., they told the ASOC that they were low on fuel and needed a target immediately or else they would have to return to base. When the ASOC could not give them a target and released them from the CAS stack, they called the TAOC and offered to strike in the 1st Marine Expeditionary Force area of operations, often receiving targets.⁴¹ On several occasions, aircrews simply freelanced, checking in with command and control agencies other than that assigned on the ATO, to avoid working with the ASOC.⁴² Matters became worse when air commanders noticed the substantial numbers of unexpended ordnance returning to base and instituted a "no weapons bring back" policy. Aircrews then became anxious to release munitions and began pressing controllers for "dump targets" such as abandoned or already destroyed vehicles.⁴³ (See Figure 5.2 for a highly simplified overview of control arrangements for control of attack aircraft during OIF.)

Inflexible and unresponsive mechanisms hindered coordination in both the V Corps and 1st Marine Expeditionary Force areas of operation. FSCL movement was published via the daily ATO, constraining its rate of advance to 24-hour increments, a pace too slow to adjust to the rapidly changing ground situation. Consequently, 3rd Infantry Division's lead element almost overran the FSCL on two occasions.⁴⁴ The ATO cycle normally took 72 hours, including the day of execution. As a result, nominating targets through this process took too long, especially for mobile targets. Anticipating this problem, the CAOC organized cells to process time-sensitive targets and other emerging threats in an expedient manner. These cells worked well for servicing

⁴⁰ Numerous references in after action reports and interviews testify that Air Force and Navy pilots preferred working with "the DASC" rather than the ASOC, because they were more likely to get expeditious target assignments in the 1st Marine Expeditionary Force area of operations. However, Marine officers interviewed at Marine Corps Combat Development Command indicated that, many times, pilots were under control of the TAOC when they thought they were under control of one of the DASCs.

⁴¹ Lieutenant Colonel (USAF) Steve Gray, "Evolving FSCM/Air C2 Issues: An Air Combat Command Perspective," HQ USAF/ACC briefing, October 30, 2003.

⁴² CAOC, p. 37.

⁴³ CAOC, pp. 31–32; MAWTS-1 LL, pp. 40–41.

⁴⁴ 3rd Infantry Division (Mechanized), pp. 32 and 112.

Figure 5.2
Control Arrangements During Operation IRAQI FREEDOM

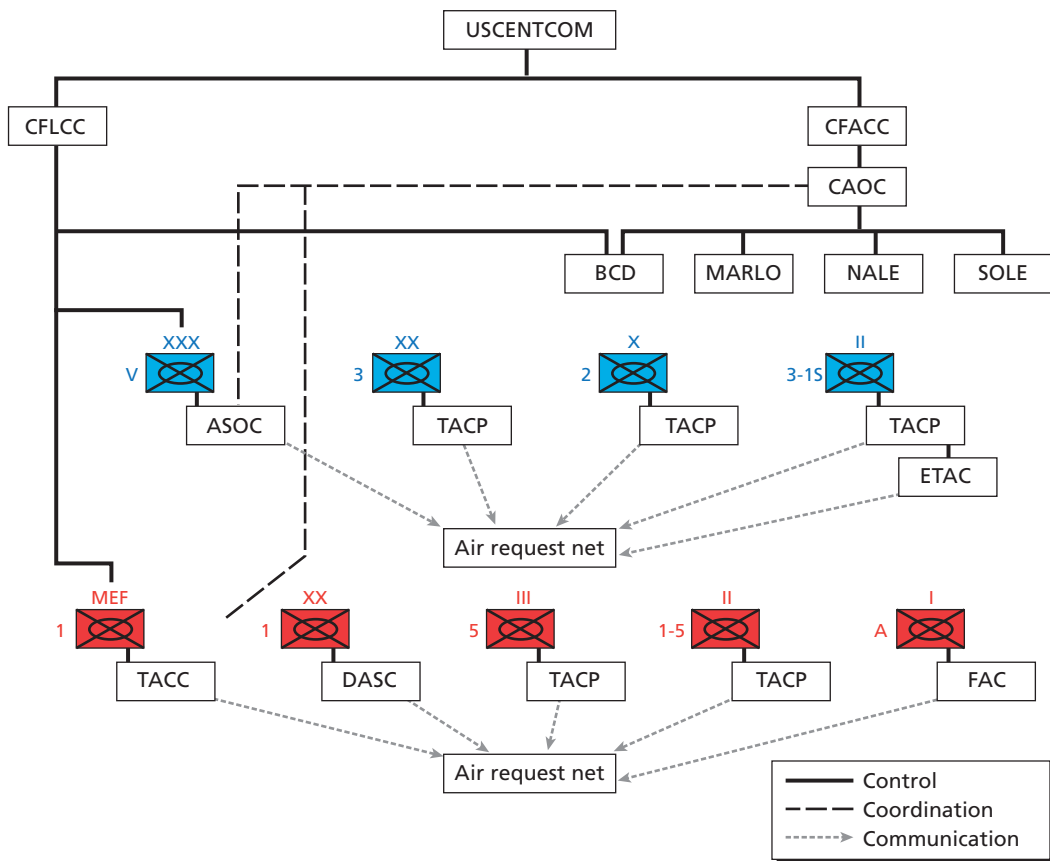

SOURCE: Chairman, Joint Chiefs of Staff, *Doctrine for Joint Fire Support*, Joint Publication 3-09, 1998, Figure III-3. Readers please note that the 1998 edition is an older version of the Joint Pub.

NOTE: ASOC = air support operations center; BCD = battlefield coordination detachment; CAOC = combined air operations center; CFACC = combined forces air component commander; CFLCC = combined forces land component commander; DASC = direct air support center; ETAC = enlisted terminal attack controller; FAC = forward air controller; MARLO = Marine air liaison officer; NALE = Navy liaison element; SOLE = special operations liaison element; TACC = tactical air command center (Marine Corps); TACP = tactical air control party; USCENTCOM = U.S. Central Command.

RAND MG641-5.2

high-priority targets. However, division- and corps-level target nominations were frequently relegated to the routine ATO process. As a result, before the analysis was done and the ATO published, the targets had often moved, been destroyed, or been over-run by ground forces.⁴⁵ Complicating matters, there was no formal process to update

⁴⁵ 1st Marine Division, "Operation Iraqi Freedom (OIF) Lessons Learned," p. 24; 3rd Infantry Division (Mechanized), pp. 102–103; MAWTS-1 LL, pp. 21, 39, 71–73; interview with Marine Corps Combat Development Command, March 2004; interview with 1st Marine Division, October 1–3, 2003.

the CAOC on changes in status of previously submitted targets, nor was there a ready mechanism for taking targets out of the ATO development cycle.⁴⁶ To compensate for these inflexibilities, 3rd Infantry Division's Tactical Command Post began submitting air interdiction requests to the ASOC, which developed targets on a 24-hour cycle, and forces in the 1st Marine Expeditionary Force area of operations turned to daily unit intentions messages and other sources of ground alert tasking to coordinate air interdiction requirements.⁴⁷ In both areas of operation, CAS stacks became the preferred sources of assets for shaping, as opposed to assigning targets through the ATO.

The Air Tasking Order

Marine Corps pilots and forward air controllers complained that the ATO contained so many data fields, including many irrelevant ones, that it was unwieldy and difficult to comprehend. Therefore, they consulted it only to get aircraft call signs and take-off times and relied on the Special Instructions to Pilots (SPINS) for more pertinent direction.⁴⁸ But that guidebook was also voluminous and did not reach everyone who needed it. Because the draft Joint Publication 3-09.3 had not been widely disseminated prior to OIF, the CFACC placed substantial portions of this draft and the killbox interdiction/CAS concept in the SPINS, creating a document of over 300 pages that was difficult for pilots and controllers to digest.⁴⁹ Moreover, the SPINS were disseminated only days before hostilities began and many controllers did not receive them.⁵⁰

Problems with the interoperability of information systems complicated efforts to coordinate supporting fires. Due to incompatibilities between the Theater Battle Management Core System used in the CAOC and the Advanced Field Artillery Tactical Data System and Automated Deep Operations Coordination System that Army and Marine Corps command centers used to integrate fires, ground units had a great deal of difficulty tracking the status of air support requests in order to deconflict upcoming

⁴⁶ Interview with Marine Corps Combat Development Command, March 2004; CAOC, p. 13. According to the CAOC-PSAB Offensive Ops Team, "There was no process that was obvious to the user that allowed for the ATO to be fluid and adapt to the changes in battle before the ATO was published." Similarly, when discussing use of the ATO and SPINS, Marine officers at Marine Corps Combat Development Command observed, "The Marines are moving toward more fluid operations while the Air Force is becoming more rigid."

⁴⁷ 3rd Infantry Division (Mechanized), pp. 101–103; ENDURING FREEDOM Combat Assessment Team, "Initial Observations Report, Operation IRAQI FREEDOM: Command and Control of Aircraft and Missiles," pp. 2–3.

⁴⁸ Interview with Marine Corps Combat Development Command, March 2004. This led the ATO to be referred to as the "bus schedule."

⁴⁹ ENDURING FREEDOM Combat Assessment Team, "Initial Observations Report, Operation IRAQI FREEDOM: Command and Control of Aircraft and Missiles," p. 2.

⁵⁰ ENDURING FREEDOM Combat Assessment Team, "Initial Observations Report, Operation IRAQI FREEDOM: Command and Control of Aircraft and Missiles." Also see 1st Marine Division, *After Action Report*, Chapter 3, p. 6.

ATO sorties with artillery and missile fires.⁵¹ The Advanced Field Artillery Tactical Data System and Automated Deep Operations Coordination System were helpful tools for sharing situational awareness within the V Corps and 1st Marine Expeditionary Force areas of operation, and they worked well for disseminating targeting data and for planning, executing, and deconflicting indirect ground fires.⁵² However, when air support requests were entered into the Advanced Field Artillery Tactical Data System, not all the data fields carried across to the Theater Battle Management Core System where the ATO resided, and even fewer fields were supported in the Interim Targeting Solution where CAOC operators developed targets. Among essential details dropped were air support request numbers and target reference numbers from the prioritized target list. Subsequently, these numbers did not appear on the published ATO, so fire coordinators were forced to cull through other data elements, such as locations and target descriptions, looking for matches in order to deconflict scheduled sorties with artillery and missile fires.⁵³

Complicating matters, CAOC operators first believed the ASOC had a fully operational Theater Battle Management Core System to monitor ATO flow and mensurate target coordinates, but about two and a half weeks into the war, they discovered that was not the case.⁵⁴ On the other hand, within component command centers, multiple systems coexisted to track situational awareness, coordinate fires, mensurate coordinates, and receive or disseminate warning data. Some of these systems were at least partially compatible; most were not.⁵⁵ Finally, Army and Marine Corps operators in command centers with access to Theater Battle Management Core System were inadequately trained in its use.⁵⁶

Other equipment shortfalls hindered fire support coordination throughout the battlespace. Inadequate access to communications equipment and bandwidth were chronic problems for ground forces in both the Army and Marine Corps areas of operation. Tactical air control parties lacked the long-haul voice and digital communi-

⁵¹ Such interoperability problems affected more than just fire support coordination. Battle damage assessment was also severely hindered.

⁵² 3rd Infantry Division (Mechanized), pp. 32, 34, 52–53, 72, and 126.

⁵³ 1st Marine Division, *After Action Report*, p. 25; “Joint Operational Fires: A 1st BCD Perspective from Operation Iraqi Freedom,” briefing presented at the Field Artillery and Joint Fires Conference, October 2003.

⁵⁴ CAOC, p. 30.

⁵⁵ 3rd Infantry Division (Mechanized), pp. 124–125. Ironically, Theater Battle Management Core System disseminated target coordinates in a format incompatible with every U.S. strike aircraft except the F/A-18 Hornet (TBMCS and Hornet used DDMSS.SS; all other aircraft used DDMM.MMM). Even command centers with access to some of the same systems did not enjoy full integration. For instance, the CAOC and CFLCC both had Automated Deep Operations Coordination System, but each had to enter updates to killbox status separately. See CAOC, pp. 11–12, 14–15, 27–28, and 39.

⁵⁶ CAOC, p. 11; ENDURING FREEDOM Combat Assessment Team, “Initial Observations Report, Operation IRAQI FREEDOM: Command and Control of Aircraft and Missiles,” p. 3.

cations necessary to control close air support effectively while on the move. Although Blue Force Tracker was available in Force XXI Battle Command Brigade and Below (FBCB2) at division level, terminal air controllers at brigade and below did not have it. The vehicles from which tactical air control parties operated were cramped, noisy, and lacked adequate protection, hindering target development and fire coordination, and not enough enlisted terminal air controllers had access to proper equipment for locating and designating targets.⁵⁷

Similarly, the Modular Universal Laser Equipment that Marine Corps forward air controllers had available for target location and designation was “antiquated, cumbersome, and unreliable.”⁵⁸ To compensate, the 1st Marine Division acquired 19 Ground Laser Target Designator II systems, but that equipment reached controllers only hours before they crossed the line of departure on G-day. Ground units were heavily dependent on line-of-sight communications equipment with ranges limited to about 30 kilometers, a distance often inadequate for coordinating fires during rapid maneuver. In an effort to augment these capabilities for OIF, the 1st Marine Division acquired additional mobile radio communications vehicles to a level of more than 100 percent above that authorized on its table of equipment. Marines also used tactical satellite links, Iridium phones, and messaging capabilities on Blue Force Tracker units whenever those devices were available.⁵⁹

Refining Coordination Measures

Over the course of the war, battle managers refined fire support coordination measures and developed tactics, techniques, and procedures to mitigate some of the problems noted above. Once the FSCL stabilized at phase line New York and coalition forces began consolidating for the attack on Baghdad, the CFLCC did not place the FSCL as far forward as it had during the opening days of the conflict. Moreover, the method of designating the FSCL evolved from phase lines to the gridlines employed in the kill-box/keypad system.⁶⁰ The ASOC began opening killboxes short of the FSCL and permitted forward air control aircraft to conduct strike coordination and reconnaissance in the V Corps area of operations, though cases in which the ASOC allowed aircrews to do terminal control were rare.⁶¹

⁵⁷ 3rd Infantry Division (Mechanized), pp. 139–140; interview with 3rd Infantry Division, 2003; interview with 15th Air Support Operations Squadron, October 2003.

⁵⁸ 1st Marine Division, “Operation Iraqi Freedom (OIF) Lessons Learned,” p. 23.

⁵⁹ 1st Marine Division, “Operation Iraqi Freedom (OIF) Lessons Learned,” pp. 30–34.

⁶⁰ The FSCL initially conformed to gridlines in the V Corps area of operations on March 31, but did not change in the I MEF area of operations until April 4, resulting in a four-day period in which a hybrid FSCL existed incorporating phase lines and gridlines. See “CFACC Update” briefings, March 31 to April 4, 2003.

⁶¹ CAOC, p. 26.

The 1st Marine Expeditionary Force also refined its fire support and airspace coordination tactics, techniques, and procedures. As Marine Corps and Navy aircraft had greater fuel constraints and lower tanker priority than many Air Force aircraft, Marine Air Command and Control operators developed ways to optimize the numbers and types of targets that strike aircraft could service in their limited flight times. Aircraft assigned to strike interdiction targets were often tasked to perform CAS on the way out and on the way back. Targets were prioritized, with enemy forces engaging marines taking highest precedence. The Marine Corps also employed a daily Reactive Attack Guidance Matrix and Battlespace Shaping Matrix to guide air operations in the rapidly changing battlespace. As Marine units had less artillery support than their Army counterparts, greater counter-fire demands were put on CAS in their area of operations, so artillery had the highest priority in the Reactive Attack Guidance Matrix, followed by enemy forces closest to marines, mobile targets, and fixed targets. Early in the conflict, the 1st Marine Expeditionary Force attempted to use JSTARS to find and target artillery, but the method was unreliable and sorties were wasted chasing false returns. Subsequently, the Marine Expeditionary Force routed Q-36 counter-battery radar data directly to the DASCs with much greater success.⁶²

JSTARS would be at risk in defended airspace and therefore could not cover all of Iraq from the start of hostilities. In addition, JSTARS is most effective when used to detect and identify movement of military vehicles in fairly large numbers, but Iraqi military forces seldom moved during OIF. JSTARS could detect, but not identify, movement of Iraqi militia in civilian-pattern vehicles, for example Ba'athist militia and Fedayeen Saddam.

As coalition forces closed in on Baghdad, battle managers crafted a set of supplemental fire support coordination measures to orchestrate fires in the urban fight. An Urban Close Air Support Concept was developed that divided the city into 55 zones conforming to the terrain and established a grid-based restricted operations zone above Baghdad. The rapid development and promulgation of this concept caused some initial confusion when it was implemented.⁶³ Nevertheless, joint warfighters ultimately employed its procedures effectively, and as operators gained experience they refined their tactics, techniques, and procedures, enabling them to reduce the time required to get clearance for fires to destroy enemy artillery lodged in high-collateral-damage locations. The 3rd Infantry Division prioritized methods of engagement and established triggers for determining what systems to employ. Precision close air support quickly became the weapon of choice in urban terrain, followed by unguided bombs,

⁶² Interview with Marine Corps Combat Development Command, 2004.

⁶³ The Baghdad Restricted Operations Zone was activated on April 3. The Urban CAS Concept of Operations was approved on April 4 and implemented on April 6. Rapid implementation resulted in some inefficiencies in CAS stack placement and aircraft weapons load-outs. Also, from April 3 to 6, the FSCL bisected the northern portion of the Baghdad Restricted Operations Zone, implying that two conflicting sets of fire support operations measures were in effect in the same battle space. See CAOC, p. 36.

cannons firing high-explosive rounds, and dual-purpose improved conventional munitions. Multiple Launch Rocket Systems were used as a last resort. Early in the fight, all fire clearance requests were sent to the Division Tactical Command Post for deconfliction, but as the battle progressed, counter-fire officers began clearing missions directly with brigade combat teams while, simultaneously, sending targeting data to selected weapons. The 3rd Infantry Division estimated that by streamlining procedures in this manner, they reduced engagement response times by at least five minutes.⁶⁴

Defense Against Ballistic and Cruise Missiles

The Patriot is a surface-to-air, mobile, air defense missile system originally conceived in the 1970s to intercept Soviet aircraft. The system has since been modified to give it broader capabilities against other types of air-breathing targets and theater ballistic missiles (TBM).⁶⁵ The Patriot Advanced Capability (PAC)-1 program was intended to give it a limited anti-tactical ballistic missile (ATBM) capability. Just prior to the 1991 Gulf War, Patriot was given further improvements under the PAC-2 program. The upgraded system was rushed into production and deployed in support of Operation DESERT SHIELD. Only three PAC-2 missiles were completed when Iraq invaded Kuwait. Despite the rapid production of 480 PAC-2s by the start of DESERT STORM, the less advanced PAC-1 version was also deployed.⁶⁶

Patriot Forces Organization

The experience of the Gulf War led the Army to create a single command for theater air and missile defense (TAMD). The 32nd Army Air and Missile Defense Command (AAMDC) was created in 1998 and was designed to be the Army's central organization for TAMD planning, integration, coordination, and execution functions, as well as for echelon-above-corps (EAC) air defense brigades and other assigned forces. As described by the 32nd Army Air and Missile Defense Command,

[When deployed to a theater of operations,] the 32nd AAMDC commander fulfills three primary roles simultaneously: (1) Theater Army Air and Missile Defense Coordinator for the Army forces in the area of operations; (2) commander of all

⁶⁴ 3rd Infantry Division (Mechanized), pp. 113–115.

⁶⁵ Michael Sirak, "How Does the Patriot System Work?" *Jane's Defence Weekly*, April 9, 2003.

⁶⁶ Anthony H. Cordesman, *Lessons of the Gulf War: 1990–1991*, Washington, D.C.: Center for Strategic and International Studies, 1994, p. 952.

in-theater EAC Army air defense units; and (3) Deputy Area Air Defense Commander to the Combined Forces Air Component Commander (CFACC).⁶⁷

The decision to engage resides with the operator. Patriot cannot be placed in an automatic firing mode, although some of the firing processes are automatic. The fire control system automatically categorizes objects identified on Patriot's radar by target type and displays them as icons on two computer screens in the engagement control station (ECS). Once the operator has given the fire command, the system chooses the best missile and moment to fire.⁶⁸

Planning and Preparation

In preparation for OIF, the 32nd AAMDC participated in exercises Lucky Warrior I in November 2002, Internal Look in January 2003, and Lucky Warrior II in February 2003. The exercises focused on developing coordination, tactics, techniques, and procedures for the 32nd AAMDC air defense missions. In Lucky Warrior I the 32nd AAMDC objectives included developing proficiency in current operations and battle staff drills, conducting tactical early warning and attack assessment, and providing operational protection. Lucky Warrior I served as a CFLCC rehearsal prior to a more comprehensive exercise, CENTCOM's Internal Look 03. Internal Look 03 was planned to be a component-level training exercise to practice the tasks required to support OPLAN 1003V.⁶⁹

Lucky Warrior II built on the experiences of Lucky Warrior I and Internal Look 03. During Lucky Warrior II, the mission of the 32nd AAMDC was to conduct a realistic operational rehearsal for major combat operations. The exercise was intended to "synchronize execution of CFLCC's COBRA II OPLAN" and to ensure a major operational role for Kuwaiti forces in the plan.⁷⁰ These exercises helped to develop a playbook for the rapid buildup of air defense forces in theater, and to fine tune command and control relationships and reporting procedures.⁷¹

Regional Air Defense

An advance party of the 32nd AAMDC arrived in theater on November 15, 2002. However, the major buildup of U.S. Patriot forces began in mid-January 2003 and

⁶⁷ 32nd Army Air and Missile Defense Command, "Operation Iraqi Freedom: Theater Army Air and Missile Defense History," September 2003, p. 3.

⁶⁸ Interview with Lieutenant Colonel Roderick Burke, Active Defense, 32nd AAMDC, and Lieutenant Colonel David Mantiplay, Plans Officer, 32nd AAMDC, February 19–22, 2004.

⁶⁹ 32nd Army Air and Missile Defense Command, pp. 23–24.

⁷⁰ 32nd Army Air and Missile Defense Command, p. 27.

⁷¹ 32nd Army Air and Missile Defense Command.

reached peak strength of 7,198 personnel on April 24, 2003.⁷² Patriot forces provided point air defense at key sites designated on CENTCOM's critical asset list. Initially the critical asset list emerged from component nominations but later grew to include additional geopolitical inputs, usually negotiated agreements with regional states. However, because these additional inputs did not come early in the process, they created difficulties in the deployment of Patriot forces. Patriot deployment to Jordan became complicated when the requirement changed from three to five Patriot units, necessitating the rapid airlift of Patriot to the country in mid-February. The five Patriot fire units were deployed to protect Amman, Prince Hasan Air Base, King Faisal Air Base, and Al Azraq Air Base. This deployment was the only time Patriot forces were airlifted during the deployment phase of OIF.⁷³

In Saudi Arabia, Patriot was deployed to protect a number of sites including Eskan, Riyadh to Ar'Ar, and Tabuk but only after CFACC was able to get additional basing access in the kingdom.⁷⁴

Kuwait was at greatest risk from Iraqi missile attack because of its proximity to Iraq and importance as a base. Kuwait took on even greater importance after Turkey refused to grant transit rights for the 4th Infantry Division (Mechanized). U.S. and Kuwaiti Patriot forces worked closely to develop an operational plan. Kuwait placed its Patriot batteries under the tactical control of the CAOC. U.S. Patriot batteries provided air defense coverage at Camp Doha and the Kuwait Naval Base. Additionally, Patriot "short stop" batteries, i.e., U.S. operators manning equipment not assigned to units, protected aircraft at the Udari range in Kuwait.⁷⁵ Older versions of Patriot equipment were deployed to states at lower risk such as Qatar, Bahrain, and Saudi Arabia.⁷⁶

Patriot assets from EUCOM were deployed to Israel. These remained under EUCOM command and control for the duration of OIF. Patriot was initially deployed to Qatar to protect Al Udeid Air Base and the CENTCOM forward headquarters in As Sayliyah. Qatar requested additional Patriot batteries to protect the liquefied natural gas production facility at Ras Laffan and the capital city of Doha. Patriot was deployed to Bahrain to protect key sites including Sheikh Isa and Riffa Air Base.⁷⁷

Defense Against Ballistic Missiles

U.S. intelligence expected that Iraq would fire missiles against Israel again as it had during DESERT STORM. Consequently, reconnaissance assets and SOF were tasked

⁷² 32nd Army Air and Missile Defense Command, pp. 23 and 29.

⁷³ Interview with Burke and Mantiply.

⁷⁴ 32nd Army Air and Missile Defense Command, p. 33.

⁷⁵ 32nd Army Air and Missile Defense Command, p. 31.

⁷⁶ Interview with Burke and Mantiply.

⁷⁷ 32nd Army Air and Missile Defense Command.

to find and destroy Iraqi missiles in the western desert. The perceived threat from ballistic missiles in OIF was heightened by fears of longer-range Iraqi missiles and by the potential use of chemical and biological warheads.

U.S. intelligence assessed that Iraq had longer-range missiles. These included the Al Hussein, assessed to have a 650-kilometer range with a 300-kilogram high-explosive warhead or a 170-kilogram chemical or biological warhead. According to one military estimate, Iraq possessed 48 of these missiles. Another longer-range missile was the Al Abbas, which was assessed to have an 859-kilometer range with a high-explosive warhead of unknown size. By comparison, the SCUD-B was assessed to have a 300-kilometer range and an 800-kilogram high-explosive, chemical or biological warhead.⁷⁸

During OIF, Iraq fired no Al Hussein and Al Abbas missiles, but did fire the shorter-range Ababil 100 and Al Samoud. Due to their short range, Ababil and Al Samoud were unsuited for use in the western desert, where the Iraqis had deployed modified SCUD missiles during Operation DESERT STORM. Instead, they were deployed in the Tigris-Euphrates Valley, where they could be concealed in complex terrain and protected by Iraqi ground forces.

The Ababil 100 was assessed as having 180-kilometer range with a 170-kilogram high-explosive warhead or a 119-kilogram chemical warhead. The Al Samoud was assessed as having a 170-kilogram high-explosive or chemical warhead. These shorter-range missiles presented a different kind of challenge because of their shorter flight times. Response windows for Patriot during OIF were very narrow, generally ranging from 30 seconds to 90 seconds. In contrast, during DESERT STORM the longer-range SCUD-C allowed response times of about 4.5 minutes.⁷⁹

On March 20, the Iraqis fired an Ababil 100 at an area used by helicopters assigned to the 101st Airborne Division. The 31st Air Defense Artillery Brigade successfully intercepted this missile using PAC-2 and guidance enhanced missiles (GEM). Had it not been intercepted, this Ababil 100 would have reached its intended target area.⁸⁰ Shortly thereafter, the brigade intercepted a second Ababil 100 using PAC-3 missiles, the first combat kill for PAC-3, a hit-to-kill missile. As coalition forces advanced into Iraq, Patriot batteries deployed forward to provide continuous coverage. On April 1, Iraqi forces fired an Al Samoud missile at a logistics support area (LSA Bushmaster). 2-1 Air Defense Artillery intercepted the Al Samoud with two PAC-3 missiles. On April 3, Iraqi forces fired three Free Rocket Over Ground (FROG)-7s from Al Hillah.⁸¹ The FROG-7 is an unguided rocket with an approximately 68-kilometer range, although this can be extended with modifications, and a 200- to 457-kilogram war-

⁷⁸ Joint Staff, "Patriot Missile Capabilities—Pac-2/Upgrades," briefing, undated.

⁷⁹ "Army OIF Report Reveals Emerging Air Defense Challenges, Threats," *Inside The Army*, October 27, 2003.

⁸⁰ 32nd Army Air and Missile Defense Command, pp. 47–48 and 103.

⁸¹ Zucchini, *Thunder Run: The Armored Strike to Capture Baghdad*, pp. 162–171.

head.⁸² These were outside Patriot coverage but caused no damage on impact. Table 5.6 lists all of the Patriot engagements from March 20 through April 1.

On April 7, the tactical operations center (TOC) of BCT-2, 3rd ID, was struck near Baghdad by an Iraqi missile, killing two embedded foreign journalists and disabling the TOC for around an hour. It is not clear, based on available sources, what type of missile was used. One source indicated it was most likely an Ababil 100 or a FROG-7. This incident suggests that the Iraqis were somehow able to identify and locate the tactical operations center.

OIF was the first operation in which Patriot provided coverage for land forces while they were maneuvering. Commanders moved Patriot batteries to defend the highest-priority assets as coalition forces advanced. Four to five batteries rotated through Camp Doha to ensure that the more experienced units moved forward.⁸³ The

Table 5.6
Missile Defense During Operation IRAQI FREEDOM

Day	Patriot			Target	Eng	Des	Notes
	PAC-2	GEM	PAC-3				
March 20		3		1 Ababil	1	1	
March 20			2	1 Ababil	1	1	
March 20				1 Ababil	0	0	Harmless trajectory
March 20				1 Ababil	0	0	Harmless trajectory
March 20	1	1		1 Ababil	1	1	
March 21		3		1 Ababil	1	1	Kuwait engaged
March 23	1	2		1 Al Samoud	1	1	Harmless trajectory
March 24		2		1 Ababil	1	1	
March 24				1 Ababil	0	0	Harmless trajectory
March 25		5		1 Ababil	1	1	U.S./Kuwait engaged
March 26				1 Ababil	0	0	Self-destructed
March 27		4		1 Al Samoud	1	1	U.S./Kuwait engaged
March 28				1 Unknown	0	0	Self-destructed
March 28				2 Seersucker	0	0	
March 29				1 Ababil	0	0	Harmless trajectory
March 31				1 Ababil	0	0	Harmless trajectory
March 31				3 Seersucker	0	0	
March 31		1		1 False	0	0	Kuwait engaged
April 1			2	1 Unknown	1	1	
Totals:	2	21	4		9	9	

NOTE: PAC-2 = Patriot Advanced Capability-2; GEM = Guidance Enhanced Missile; PAC-3 = Patriot Advanced Capability-3; Eng = Engaged; Des = Destroyed.

⁸² Duncan Lennox (ed.), "FROG 7 (M21/52, R-65/70 Luna-M)," *Jane's Strategic Weapons Systems*, Surrey, UK: Jane's Information Group Inc., January 2004.

⁸³ Burke and Mantiply, 2004; LTC Tim Keppler, Assistant Director of Combat Development, interview, Fort Bliss, February 20, 2004.

most advanced Patriot missiles, i.e., PAC-3, were in limited supply during OIF. Prior to combat operations there were only 44 PAC-3 missiles and 115 GEM missiles available in theater.⁸⁴

Moving together with land forces presented operational challenges. The logistics tail for Patriot forces was close to 400 kilometers long. As a result, support and security became difficult. The difficulty was well illustrated by the incident involving the 507th Maintenance Company, which inadvertently traveled into Iraqi-held territory in An Nasiriyah, resulting in heavy loss.⁸⁵

The Challenge of Cruise Missiles

On March 19, a modified Seersucker cruise missile struck just outside Camp Commando in Kuwait, which was being used by Marine Corps forces. It impacted less than one kilometer from the Administration Center of the 1st Marine Division.⁸⁶ On March 29, Iraq launched two Seersuckers against the harbor of Kuwait City. One of these missiles struck near the Souk Sharq, a seafront mall, severely damaging a theater and causing minor injuries to a workman.⁸⁷ On March 31, Iraq launched two Seersuckers, one at the city of Umm Qasr and the other at troops near Safwan. In response, U.S. SOF were directed to locate and destroy Seersucker missiles and their launchers. They discovered several launchers concealed on the Faw Peninsula. Additionally, the UK ship HMS *York* was deployed off Kuwait City to intercept cruise missiles. UK forces discovered other cruise missiles at As Shuaybah airport, including Soviet-built SS-N-2 Styx that had been removed from boats.⁸⁸ Kuwait used metal “billboards” (radar reflectors) to attract cruise missiles, such as Seersucker, that are designed to home in on metal objects. One Seersucker apparently struck one of these billboards. Iraq ultimately inflicted very little damage with its crudely modified Seersuckers, but a future adversary might well conduct more effective attacks with cruise missiles or unmanned aerial vehicles.

Issues in Air Defense

There were three incidents of fratricide related to air defense during OIF: a Patriot engaging a UK GR4 Tornado aircraft; a U.S. Air Force F-16CJ engaging a Patriot radar; and a Patriot engaging a U.S. Navy F/A-18 aircraft. These incidents demonstrated shortfalls in Patriot training and operating practices, as well as broader prob-

⁸⁴ 32nd Army Air and Missile Defense Command, 2003, p. 37.

⁸⁵ See Chapter Four, pp. 64–85.

⁸⁶ 1st Marine Division, *After Action Report*.

⁸⁷ CNN, March 29, 2003, based on reports from the Kuwaiti News Agency and the Ministry of Information.

⁸⁸ David C. Isby, “Iraqi Seersucker Attacks Boost US Cruise Missile Defense Plan,” *Jane’s Information Group*, August 1, 2003.

lems associated with operating Patriot in a joint environment. U.S. forces require better coordination of combined air operations to prevent similar incidents in the future and to ensure that Patriot is optimally employed.

During the night of March 22, a U.S. Patriot battery equipped with PAC-2 missiles destroyed a UK GR4 Tornado aircraft. A two-ship flight of Tornados with call signs Yahoo-75 and Yahoo-76 overflew the Patriot battery without being aware of its presence. The leader Yahoo-75 was not engaged by Patriot and returned to base safely. As the wingman Yahoo-76 overflew the Patriot battery, he descended steeply in order to land at Ali Al Salem Air Base, and his flight profile momentarily matched the Patriot's parameters for an anti-radiation missile. The Patriot crew was recently trained and inexperienced. It was operated autonomously with little access to the wider air picture. The tactical control officer decided to exercise self-defense under the rules of engagement and engaged what she thought was an incoming anti-radiation missile, although no Iraqi aircraft were flying at the time.

An E-3 Airborne Warning and Control System (AWACS) aircraft had successfully interrogated Yahoo-75, which was squawking in all Interrogation Friend-or-Foe (IFF) modes. On the basis of this identification, the AWACS tracked Yahoo-75 and Yahoo-76 as a friendly flight, but the Patriot battery had no access to this air picture. Yahoo-76 successfully tested for IFF returns on the ground, but apparently failed to squawk in any mode while airborne. The United States and United Kingdom conducted parallel investigations of the incident. The UK Board of Inquiry recommended that work be conducted to research the failure modes, reliability, and serviceability of the Tornado IFF system. However, the UK investigators also identified flaws in Patriot engagement procedures and overly broad parameters for identification of anti-radiation missiles as causes of the fratricide.⁸⁹

On March 24, an F-16CJ aircraft fired an AGM-88 high-speed anti-radiation missile at a Patriot PAC-3 battery deployed about 30 miles south of An Najaf. The F-16CJ pilot believed incorrectly that he was being tracked for engagement by the Patriot radar. He was not aware of the presence of Patriot in the area. The missile damaged a Patriot radar but caused no casualties.

On April 2, a Patriot battery equipped with PAC-3 missiles engaged a U.S. Navy F/A-18 aircraft while deployed near Karbala. The Patriot crew was expecting to engage Iraqi ballistic missiles because U.S. forces had begun an assault on Baghdad, presumably prompting Saddam Hussein to launch whatever missiles he still had available. In some poorly understood way, perhaps through a "ghost track" (spurious radar return), the Patriot identified an incoming ballistic missile that never existed and conflated this identification with the F/A-18. It would, of course, be impossible for an F/A-18 aircraft

⁸⁹ Ministry of Defence, "Aircraft Accident to Royal Air Force Tornado GR MK4A ZG710," London, England: Directorate of Air Staff, 2003; Victoria Samson, "The PATRIOT/TORNADO Fratricide: It Could Happen Again," Center for Defense Information; Bradley Graham, "U.S. Soldiers Cleared in Downing of British Jet," *Washington Post*, May 18, 2004, p. 12.

to satisfy the parameters of a ballistic missile. Once the false identification had been made, Patriot continued to track the F/A-18 and display the icon that represented a ballistic missile. The parent battalion confirmed the target identification and the crew fired two missiles. One of these missiles sliced through the cockpit of the aircraft.⁹⁰

Training and Operations. Patriot forces were insufficiently trained to operate in the complex conditions they experienced during OIF. High levels of electromagnetic energy caused by many electronic systems operating in close proximity generated spurious “ghost tracks,” i.e., tracks that did not correspond to any actually existing object. Spurious tracks had appeared during DESERT STORM, yet they were not represented in the simulations used to train Patriot operators. Spurious tracks were added to Patriot training after the end of major combat operations in OIF. Spurious tracks contributed to false alarms that eventually caused warning fatigue among coalition troops. In the first days of the war, the warning siren sounded eight times in a 24-hour period at Camp Doha. Six of these may have corresponded to actual incoming ballistic missiles, while two were clearly false alarms. On some days, three to four false alarms occurred.⁹¹ When the alarm sounded, coalition personnel had to don masks and protective clothing.

During OIF, shortstop units equipped with older float equipment were employed until newer equipment arrived in theater. Shortstop units operated independently and without full communications suites. Some of the operators in shortstop units had insufficient training to operate safely in a complex environment. Following the experience of OIF, Patriot shortstop units will probably not be used in future operations.

Joint Airspace Management. Patriot operations are ultimately a joint issue that requires closer coordination among the services. Despite several exercises, operation of Patriot and friendly aircraft in a joint airspace was not adequately managed during OIF. Pilots were not informed of Patriot locations and operating parameters. Conversely, Patriot operators often had little appreciation of friendly and enemy air activity in their areas of responsibility.

⁹⁰ Robert Riggs, “Blue on Blue, How Did an Army Patriot Missile Battery Shoot Down a Navy F-18?” CBS, February 5, 2004.

⁹¹ “U.S. Ground Forces in Iraq Wearied of Repeated False Missile Alarms,” *Inside Missile Defense*, July 8, 2003.

Why the Iraqi Resistance Was So Weak¹

Stephen T. Hosmer

In Operation IRAQI FREEDOM, coalition forces captured Baghdad and deposed Saddam Hussein's regime in less than three weeks. This chapter focuses on two questions relating to the rapidity and ease of that victory: (1) why the vast majority of Iraqi forces failed to offer significant or effective resistance, and (2) why the Iraqi leaders eschewed adopting certain defensive measures that would have made the coalition invasion more difficult and costly.

The Weak Iraqi Resistance

The takedown of Saddam's regime was accomplished without the hard fighting that had been anticipated and at the cost of relatively few allied casualties. Between March 19, when the attacks commenced, and May 1, when President Bush declared the end of major combat operations, U.S. forces lost 109 personnel killed in action. Another 542 U.S. personnel were wounded in action.² British losses were proportionately even lighter than those of the United States. The capture of Basra cost only three UK killed in action, in part because of the cautious tactics employed by UK commanders.³

The forces charged with defending Iraq numbered in excess of 350,000 troops and included 17 regular army divisions (three of which were armored and three mechanized), six Republican Guard divisions (three of which were armored and one mecha-

¹ Research for this chapter was conducted within the Strategy and Doctrine Program of Project AIR FORCE and the Strategy, Doctrine, and Resources Program of RAND Arroyo Center. The Project AIR FORCE research was sponsored by the Director, Plans and Programs, Headquarters Air Combat Command, and the RAND Arroyo Center research was co-sponsored by the Deputy Chief of Staff, G-3, and the Deputy Chief of Staff, G-8, United States Army.

² Of the wounded, 116 were returned to duty within 72 hours. See U.S. Department of Defense, "Operation Iraqi Freedom Casualty Update," as of March 11, 2005, 10:00 A.M., EST.

³ Transcript of the episode of the PBS program *Frontline* entitled "The Invasion of Iraq," first aired February 26, 2004. As of August 2007:
<http://www.pbs.org/wgbh/pages/frontline/shows/invasion/etc/script.html>

nized), one Special Republican Guard division, special operations and reserve forces, and numerous militia units. The force was equipped with over 2,200 tanks, 2,400 armored personnel carriers (APCs) and 4,000 artillery pieces.⁴

The armored and infantry divisions of the Iraqi regular army did little if any fighting. Most important, some of the Iraqi units the coalition had expected to put up the stiffest fight, the Republican Guard armored and infantry divisions and the Special Republican Guard elements, also offered very little resistance.⁵ In the course of the advance to Baghdad, on only one or two occasions did U.S. ground forces confront an enemy unit of more than battalion size.

By the time coalition forces entered Baghdad, the Iraqi army had largely dissolved. But formal Iraqi surrenders were comparatively few. Out of a total enemy force of some 350,000, only about 7,000 (2 percent) were taken prisoner by coalition forces. This is in comparison to the more than 85,000 Iraqis captured by coalition forces in the 1991 Gulf War.⁶ Not a single organized Iraqi military unit remained intact when major combat ended. All the Iraqis who survived the war had “self-demobilized” by going home.⁷

The Iraqi Failure to Exploit More Effective Defensive Options

Saddam’s defensive deployments and combat strategy proved ineffective. Coalition units rapidly cut through a generally weak Iraqi defense and occupied Baghdad. Surprisingly, the Iraqis failed to employ a number of defensive measures and tactics that would have made the coalition’s invasion more difficult and costly. Among other missed opportunities, the Iraqis failed to:

- Block and delay coalition use of the port at Umm Qasr by sinking ships in the harbor and destroying handling facilities.
- Mine the roads and destroy the many bridges that lay along the routes of the coalition’s advance.
- Flood the lower Tigris and Euphrates river valleys and other potential lines of communication (LOCs) and choke points by destroying dams and dikes.
- Torch oil fields and other oil facilities, on a wide scale.

⁴ Fontenot, Degen, and Tohn, p. 100.

⁵ During OIF, Special Republican Guard elements played no role in combat as maneuver units. See Charles Duelfer, Special Adviser to the Director of Central Intelligence, *Comprehensive Report of the Special Adviser to the DCI on Iraq’s WMD*, Vol. I, September 30, 2004, p. 93.

⁶ Stephen T. Hosmer, *Effects of the Coalition Air Campaign Against Iraqi Ground Forces in the Gulf War*, Santa Monica, CA: RAND Corporation, MR-305/1-AF, 2002, p. 170.

⁷ Walter B. Slocombe, “To Build an Army,” *Washington Post*, November 5, 2003, p. A29.

- Prepare extensive hardened fighting positions and other defenses in urban areas.
- Deploy a large portion of Iraq's infantry and armored forces in Baghdad, Basra, and the other urban centers to fight in these built-up areas.

Sources

Interviews with former senior Iraqi civilian and military officials, combatant commanders, and enlisted personnel provide authoritative insights as to why the Iraqi resistance to the coalition invasion in spring 2003 was so weak. For purposes of this chapter, the author has drawn upon two sources of interviews: (1) former senior Iraqi military officers who were not detained by coalition forces but who freely submitted to interviews by U.S. and foreign news media, and (2) so-called high-value detainees mostly held at Camp Cropper in Baghdad who were debriefed and interrogated under the supervision of U.S. government personnel. The high-value detainees included Saddam Hussein and many of the key political and military officials who populated his regime and senior officer corps. Much of the substance of these governmental interrogations was published on September 30, 2004, in Charles Duelfer's *Comprehensive Report of the Special Adviser to the DCI on Iraq's WMD*. However, the interrogation reports containing the statements of the various high-value detainees remain classified.

Caution must be exercised in weighing testimony from participants in a losing cause. There is the risk that the sources will present their own actions in a self-serving light and blame others for Iraq's poor military showing and easy defeat. Statements by high-value detainees about their own role in the Iraqi regime and their own possible liability for its nefarious activities must be viewed with particular caution, as the prospect of prosecution is likely to have constrained the detainee's candor and otherwise influenced his answers. Moreover, some detainee testimony may have been contaminated by the fact that the Iraqis held at Camp Cropper were able to interact freely among themselves and exchange information about the questions they had been asked and the answers they had tendered.⁸

Even taking account of these cautionary considerations, we believe that the statements by Iraqi sources concerning the issues addressed in this report are by and large credible. First, this study does not focus on topics (such as the past use of WMD, abuse of human rights, and responsibility for aggression) that are likely to be subjects of future criminal trials. Second, there is a consistency between the information freely provided by Iraqi sources to the news media and the information extracted from high-value detainees by official interrogators.⁹ Third, the interviews of Iraqi rank-and-file

⁸ Duelfer, p. 2.

⁹ One reporter who interviewed a number of Iraqi officers after the war found that "the close parallels among experiences described by military leaders from field units, headquarters, divisions, and Special Forces assigned to

soldiers tend to confirm the statements of the senior officers. Finally, the information presented by the Iraqi sources is entirely consistent with the Iraqi military and diplomatic behavior observed during the period leading up to OIF and with Iraq's battlefield performance during the course of the conflict that followed.

Themes of the Chapter

The analysis presented in the following sections examines the various causes for the surprisingly vulnerable Iraqi defensive posture at the start of OIF and the extraordinarily weak Iraqi resistance to the coalition invasion. The analysis shows that Iraq's rapid collapse was due to a combination of the following:

- Saddam's strategic miscalculations, which were of great importance in that all key decisions relating to the defense of Iraq rested with the Iraqi leader.
- The consequences of Saddam's preoccupation with internal threats to his person and regime.
- The shortcomings in planning, leadership, command and control, coordination, battlefield positioning, situational awareness, and training that plagued the Iraqi forces, and the obsolete equipment given to those forces.
- The poor motivation and morale of the vast bulk of the officers and enlisted personnel serving in the regular army and Republican Guard.
- The superior attributes of U.S. and coalition military forces, particularly their professionalism, mobility, and ability to apply devastatingly accurate firepower.

Saddam's Strategic Miscalculations

One of the major reasons Iraq failed to adopt the more robust defensive measures that could have made the coalition invasion more difficult and costly was that Saddam Hussein seriously miscalculated the prospects of conflict with the United States and the nature and intensity of the attacks that Iraq might face, should war come about. Saddam had a propensity for such miscalculation that stemmed in large part from his dysfunctional personality and cognitive traits, his limited grasp of international and military affairs, and the cultures of "fear" and "lying" that his rule engendered, which discouraged any offers of countervailing advice and information from intimidated subordinates. Saddam's misjudgements about coalition intentions and capabilities importantly shaped Iraqi behavior both before and during the 2003 conflict.

a wide variety of locations buttressed their credibility." See Molly Moore, "A Foe That Collapsed from Within," *Washington Post*, July 20, 2003, p. A1.

Because Saddam Hussein was the dominant decisionmaker in Iraq, these miscalculations shaped Iraq's political-military responses to the crisis over Iraq's presumed possession of weapons of mass destruction (WMD) and the coalition's impending attack.

Saddam's writ in Iraq was both sweeping and absolute. He formally controlled every state, administrative, Ba'ath Party, and military hierarchy in the country: He simultaneously held the posts of President, Prime Minister, Chairman of the Revolutionary Command Council (RCC), General Secretary of the Ba'ath Party, and Commander in Chief of the Armed Forces.¹⁰

Saddam's major strategic decisions were made by fiat, often without consultation or reflection. He was prone to micromanage all aspects of government. This propensity was most evident in the early period of his rule. After the mid-1990s, when Saddam became more security conscious and reclusive (he took to writing novels), he had less immediate contact with the government.¹¹ During this later period, Saddam relied increasingly on verbal instructions passed to a network of family and other trusted subordinates to administer Iraq's affairs. When the Iraqi leader failed to provide specific guidance on a matter, his subordinates were forced to act "upon what they perceived to be indirect or implied orders from him."¹²

But Saddam's bent for micromanagement—particularly in military and security areas—never disappeared and was still manifest in the final months of his rule. He maintained command over Iraq's armed forces, militias, and intelligence services, and exercised direct authority over the plans and operations of these organizations. Reporting directly to Saddam or to Saddam through his two sons Qusay and Uday or through other loyal and pliable subordinate officials—were the Republican Guard (RG), the Special Republican Guard (SRG), the regular army, the Fedayeen Saddam militia, the Ba'athist Militia, the Al Quds Army, and Iraq's four intelligence agencies.¹³

According to the former Iraqi minister of defense, Naji Sabri Ahmad Al Hadithi, Saddam addressed military and military industrialization issues directly with the minister of defense or the minister of military industrialization without the intermediate filter of any cabinet, RCC, or other governmental discussion. However, these officials exercised little or no independent authority. Except for issues involving the Republican Guard, over which he had no authority, the Iraqi minister of defense is said to have forwarded all military matters of any significance to Saddam for his consideration and approval. Issues relating to the Republican Guard were discussed directly by Saddam with his son Qusay, who had overall supervision of the Republican Guard, and the

¹⁰ Duelfer, p. 5.

¹¹ After 1998, Saddam manifested less grasp of details and would often come to ministers' meetings unprepared. See Duelfer, pp. 9 and 12.

¹² Duelfer, p. 5.

¹³ Duelfer, pp. 5 and 16.

Republican Guard Chief-of-Staff.¹⁴ In addition, Saddam was prone to give instructions directly to subordinate battlefield commanders.

Saddam's Flawed Decisionmaking

Saddam's propensity for strategic miscalculation can be attributed to his congenital optimism, excessive self-confidence, and poor understanding of international and military affairs. The erroneous assumptions underlying his decisions went unchallenged because he was surrounded by equally uninformed sycophants and other subordinates who were fearful of conveying bad news or telling him truths that they believed he did not want to hear. The climate of fear Saddam engendered nurtured a "culture of lying" whereby senior military officers routinely misled Saddam about the readiness and fighting will of their forces.

One of Saddam's more marked characteristics was optimism. Amatzia Baram has described Saddam as a man who "always believes that things are going to turn out in his favor, no matter how bad they might look to others." This unabated optimism was shaped by the Iraqi leader's "life of achievements in the face of overwhelming odds." Saddam believed his mother had attempted to abort him and that "his very birth was his first victory in a struggle to survive." According to Baram, Saddam's "remarkable success in rising to the top and staying in power despite all of his initial disadvantages had convinced him that he was marked out by destiny."¹⁵

The fact that he was able to survive potentially fatal mistakes—like the invasions of Iran and Kuwait—only fueled his self-confidence. Indeed, according to Saddam's former presidential office director, Hamid Yusif Hammadi, "after the Iran-Iraq War, Saddam was intoxicated with conceit. He believed he was unbeatable."¹⁶ Incongruously, Saddam even persistently claimed both privately and publicly that the 1991 Persian Gulf War had ended in an Iraqi victory.¹⁷

Saddam's megalomania was manifest in his sometimes-stated aspiration "to be remembered as a ruler who had been as significant to Iraq as Hammurabi, Nebuchadnezzar and Salah-al-Din [Saladin]." As a consequence, he was prone to manage his present affairs always with a view to how his actions might be viewed by future generations.¹⁸

¹⁴ This according to the testimony of former Iraqi deputy prime minister, Tariq 'Aziz. See Duelfer, p. 16.

¹⁵ See Amatzia Baram, "Would Saddam Husayn Abdicate?" Iraq Memo #9, Washington, D.C.: The Brookings Institution, February 4, 2003, pp. 1–2.

¹⁶ Hammadi was former Secretary of the President and presidential office director, 1982–1991. Duelfer, p. 26.

¹⁷ Saddam tended to see his life as a "relentless struggle against overwhelming odds, but carried out with courage, perseverance and dignity." In the context of the "Mother of All Battles"—Saddam's name for the 1991 Persian Gulf War—"Saddam showed a stubbornness arising from such a mindset and a refusal to accept conventional definitions of defeat." In Saddam's reckoning, even a hollow victory was "a 'real one.'" Duelfer, p. 20.

¹⁸ Duelfer, p. 22.

Moreover, when facing potential crises, Saddam had a propensity for willful distortion of facts and interpretation of events to fit his preconceived notions. Once Saddam “has determined how he expected and wanted a situation to evolve, he tends to disregard evidence and interpretations that might undercut his optimistic scenario and focus only on information and explanations that would support what he wants to be true.” Thus, he invariably interpreted “all of the available data to conform to what would be best for him.”¹⁹ These propensities led Saddam to take major risks.

Saddam’s interests and experience had provided him with only a limited understanding of the outside world. He rarely traveled abroad, and his foreign affairs interests focused primarily on the Arab nations. According to the assessment of his former foreign minister, Tariq ‘Aziz, Saddam “lacked a full grasp of international affairs”:

Saddam perceived Iraqi foreign policy through the prism of the Arab world and Arabic language. He listened to the Arabic services of Voice of America and the BBC, and his press officers would read him translations of foreign media, but he appeared more interested in books and topics about the Arab world.²⁰

Saddam’s insight into the outside world was apparently also gleaned from motion pictures. He watched classic U.S. movies and told a U.S. interviewer that he relied on movies to understand Western culture.²¹

Saddam’s understanding of the United States was clouded at best. He failed to understand U.S. interests and the internal and external drivers that shaped U.S. policy. For example, he completely misread the import of 9/11 as it might influence U.S. attitudes toward Iraq. He was the only Arab leader who failed to express sympathy to the American people and to condemn the terrorist attacks. With this lapse, Saddam’s colleagues believed he missed a major opportunity to reduce tensions with the United States. Instead, he “reinforced U.S. suspicions about his connections to al-Qaeda and certified Iraq’s credentials as a rogue state.”²²

Saddam viewed Iran as more of a threat to Iraqi security than the United States.²³ He and other senior Iraqi officials looked upon Iran as Iraq’s “abiding enemy” and

¹⁹ Kenneth M. Pollack, *The Threatening Storm: The Case for Invading Iraq*, New York: Random House, 2002, p. 254.

²⁰ Duelfer, p. 8.

²¹ Duelfer, p. 8.

²² Saddam reportedly rejected advice from his cabinet to offer condolences to the United States. According to the Duelfer report, “he told his minister that after all the hardships the Iraqi people had suffered under sanctions he could not extend official condolences to the United States, the government most responsible for blocking sanctions relief. From a practical standpoint, Saddam probably also believed—mistakenly—that his behavior toward the United States was of little consequence, as sanctions were on the verge of collapse.” Duelfer, pp. 33 and 57.

²³ During the 1990s, Saddam and members of his inner circle considered a full-scale invasion of Iraq by American forces “to be the most dangerous potential threat to unseating the Regime, although Saddam rated the prob-

sought to keep the threat posed by Tehran in check. In addition to possible invasion, Saddam worried that Iranian infiltrators might foment internal unrest in the country.²⁴ Saddam's interest in Iraq's development of WMD was driven in part by the growth of Iranian weapons capabilities. Because of his concerns about Iran, Saddam was loath to publicly proclaim that Iraq no longer possessed WMD. As the Duelfer report points out:

This led to a difficult balancing act between the need to disarm to achieve sanctions relief while at the same time retaining a strategic deterrent. The Regime never resolved the contradiction inherent in this approach. Ultimately, foreign perceptions of these tensions contributed to the destruction of the Regime.²⁵

Some high-ranking Iraqi detainees attributed Saddam's unwillingness to categorically disavow possession of WMD to his fear that he would lose face with his Arab neighbors such as Saudi Arabia, Kuwait, and the United Arab Emirates that paid him deference because they thought he had weapons of mass destruction. Senior Iraqi generals offered a similar view, stating that Saddam "had an inferiority complex" and "wanted the whole region to look at him as a grand leader." But the generals also believed that "during the period when the Americans were massing troops in Kuwait, he wanted to deter the prospect of war."²⁶ By this account, Saddam failed to grasp, until it was too late, that the U.S. perception that Iraq possessed WMD was a spur to invasion, not a deterrent to one.

Saddam was also largely unschooled in military affairs. Iraqi general officers captured during the 1991 Gulf War spoke disparagingly of Saddam's military ken. They characterized the Iraqi leader as a "gambler" lacking in military judgment and experience. As one senior Iraqi officer commenting on the Iraqi defeat put it: "Saddam has never worn combat boots, dug a foxhole, done PT, or lived through what soldiers live through. Yet he pretends to lead the military, and we can see the results."²⁷

Saddam's decisionmaking was further distorted by his lack of exposure to countervailing information or opinion. Because his intelligence services focused in the main

ability of an invasion as very low." According to Tariq 'Aziz, "Saddam did not consider the United States a natural adversary, as he did Iran and Israel, and he hoped that Iraq might again enjoy improved relations with the United States." See Duelfer, p. 31.

²⁴ See Duelfer, pp. 29–30, 72.

²⁵ See Duelfer, p. 34.

²⁶ Steve Coll, "Hussein Was Sure of Own Survival; Aide Says Confusion Reigned on Eve of War," *Washington Post*, November 3, 2003, p. A1.

²⁷ Hosmer, p. 86.

on internal threats, they were not well positioned to provide Saddam with a “comprehensive or objective picture of his strategic situation.”²⁸

The Iraqi leader’s key advisors both were loath to offer opinions contrary to Saddam’s and were themselves largely untutored in international and military affairs. The members of the Committee of Four (the Quartet)—who supposedly constituted Saddam’s most senior advisory group—“had only a limited and hazy view of the United States, its interests, and how policy was formed and driven in Washington.”²⁹ Moreover, the Quartet offered no proactive advice or recommendations contrary to what the Quartet members perceived to be Saddam’s predisposition on issues. As a consequence, the Quartet failed to have a significant effect on Saddam’s policy on any important matter.³⁰

Saddam employed violence and patronage as administrative methods to ensure loyalty and compliance with his orders and to repress criticism of any sort, helpful or not.³¹ His willingness to order the jailing or execution of those he thought disloyal was in the forefront of the minds of his subordinates. As a result, Saddam came to be surrounded by sycophantic military and civilian officials who would tell the Iraqi leader only what they thought he wanted to hear. All were aware of Saddam’s penchant to punish the bearers of bad news and, in particular, persons who had had the temerity to disagree with him. As Jerrold Post, a long-term government psychologist and expert on Saddam, put it: “One criticizes a policy or decision of Saddam’s at great peril for to criticize Saddam is to be disloyal, and to be disloyal is to lose one’s job or one’s life.”³²

Interviews with Saddam’s key aides underline the extent to which their advice was constrained by their fear of Saddam and their concern they might lose the patronage and appearance of power he provided them. At the meetings of the Revolutionary Command Council (RCC), which was purported to be Iraq’s highest-ranking decisionmaking body, Saddam made all the decisions and “there was never any objection

²⁸ Pollack, p. 255.

²⁹ Tariq ‘Aziz, who had some grounding in international affairs and was a member of the Quartet, constituted a partial exception to this statement. However, “at no stage did the Quartet demonstrate a strategic concept of what the U.S. wanted with Iraq, where common ground and differences really lay, and the nature of the challenge the U.S. or Coalition presented. Nor did they have a strategy for dealing with the West, apart from tactical games at the UN.” The other members of the Quartet were ‘Izzat Ibrahim Al Duri, Taha Yasin Ramadan Al Jizrawi, and ‘Ali Hasan Al Majid. Duelfer, pp. 6 and 71.

³⁰ Duelfer, pp. 70–71.

³¹ Duelfer, pp. 8–9 and 12. Toby Dodge writes that on a broader scale, Saddam “used extreme levels of violence and the powers of patronage delivered by oil wealth to co-opt or break any independent vestiges of civil society” in Iraq. “Autonomous collective societal structures beyond the control of the state simply [did] not exist. In their place, society came to be dominated by aspects of the ‘shadow state,’ flexible networks of patronage and violence that were used to reshape Iraqi society in the image of Saddam Hussein and his regime.” See Toby Dodge, *Inventing Iraq: The Failure of Nation Building and a History Denied*, New York: Columbia University Press, 2003, p. 159.

³² Quoted in Pollack, p. 254.

to his decisions.”³³ One of Saddam’s cousins and most trusted subordinates, ‘Ali Hasan Al Majid (Chemical Ali) indicated that he knew of no instance when anyone had brought bad news to Saddam.³⁴ According to the former minister of industry, Abdal-Tawab ‘Abdallah Al Mullah Huwaysh, no minister at a cabinet meeting would ever argue against Saddam’s stated position because it would be “unforgivable. It would be suicide.”³⁵

The muting of contrary opinion had a pernicious effect on Iraqi policies. One of Saddam’s vice presidents, Taha Yasin Ramadan Al Jizrawi, reports that from late 2002 onward he was convinced that Iraqi policy toward the United States and the UN was taking the country toward a disastrous war. However, he reports that he was intimidated from pushing the issue with Saddam: “I couldn’t convince Saddam that an attack was coming, I didn’t try that hard. He was monitoring my performance in managing [UN] inspectors.”³⁶

Saddam’s Strategic Miscalculations in 2003

According to the testimony of Saddam’s former high-ranking aides, the Iraqi leader profoundly misread the situation facing Iraq in late 2002 and early 2003. Among other miscalculations, the aides report that Saddam believed (1) the United States would not attack Iraq, (2) if the United States did attack, it would be by air and not by ground invasion, and finally, (3) if the United States did invade, Iraqi forces, by employing the strategy Saddam had devised, would be capable of forcing the United States to accept a political settlement that left his regime in power. These erroneous assumptions stemmed in large part from the shortcomings in Saddam’s decisionmaking discussed above and from the Iraqi leader’s penchant for relying on misleading historical analogies as guides for likely future U.S. behavior.

Saddam apparently believed until early 2003 that war with United States could be avoided. Saddam’s misreading of U.S. interests and objectives with regard to his regime was a key reason for this belief. His subordinates report that Saddam had told them on numerous occasions that following the 1991 war, the “United States had achieved all it wanted in the Gulf.” According to detainee interviews, “by late 2002 Saddam had persuaded himself, just as he did in 1991, that the United States would not attack Iraq because it already had achieved its objective of establishing a military presence in the region.”³⁷

³³ This according to Muhammad Hamzah Al Zubaydi, a former member of the RCC. See Duelfer, pp. 5 and 14.

³⁴ Duelfer, p. 11.

³⁵ Duelfer, p. 19.

³⁶ Duelfer, p. 19.

³⁷ This and other testimony belies Saddam’s claim during interrogation that “it was clear to him, some four months before the war, that hostilities were inevitable.” See Duelfer, p. 32.

Saddam also overestimated what France, China, and Russia might do in the United Nations Security Council to constrain a U.S. attack.³⁸ He believed that time was on his side and that the United States would never be allowed to attack.³⁹

Tariq 'Aziz, Iraq's former deputy prime minister and former foreign minister, reportedly told his U.S. interrogators that Russian and French intermediaries had persuaded Saddam that "he might yet avoid a war that would end his regime, despite ample evidence to the contrary."⁴⁰ According to 'Aziz's account, the French and Russian intermediaries repeatedly assured Saddam during meetings in late 2002 and early 2003 "that they would block a U.S.-led war through delays and vetoes at the UN Security Council."⁴¹

Finally, Saddam believed he could forestall any attacks by demonstrating that Iraq possessed no WMD and was fully cooperating with United Nations Monitoring, Verification, and Inspection Commission (UNMOVIC) inspections. He apparently calculated that Iraq's cooperation with UNMOVIC would not only remove a *casus belli* but would also bring sanctions to an end. In December 2002, Saddam assembled senior Iraqi officials and directed them to cooperate completely with inspectors. He ordered the Republican Guard, which in earlier years had obstructed inspections, to prepare to have an "open house" for UNMOVIC inspectors "day and night."⁴² This zeal to cooperate was readily apparent to the weapons inspectors. Hans Blix, the executive director of UNMOVIC, reports that in early 2003, the "Iraqis had become much more active—even frantic—in their cooperation."⁴³

Iraq's energetic public diplomacy in the weeks before the March 19 attack suggests that Saddam had hopes of generating political pressures within the international community that would stave off a U.S.-led onslaught. As late as March 15, the Iraqi Foreign Ministry invited the UN's two chief weapons inspectors to travel to Iraq "at the earliest possible date" to discuss "means to speed up joint cooperation in all fields." To demonstrate its willingness to cooperate, Iraq offered the names of several dozen Iraqi scientists and other persons who had participated in the destruction of WMD, invited UN inspectors to conduct tests at sites where chemical or biological agents were said to have been dumped or destroyed, and continued to flatten the Al Samoud-2 missiles that the UN had found to exceed permitted range limits.⁴⁴

³⁸ Duelfer, p. 49.

³⁹ Duelfer, p. 67.

⁴⁰ 'Aziz described the man he had long served as a "distracted, distrustful despot" by the eve of the war. See Coll.

⁴¹ Both the French and the Russian governments denied having conveyed the messages alleged to them. See "France Denies Coaxing Saddam on Invasion," Associated Press, November 4, 2003.

⁴² Duelfer, p. 63.

⁴³ Hans Blix, *Disarming Iraq*, New York: Pantheon Books, 2004, p. 196.

⁴⁴ For a description of the various measures Iraq employed to buttress its claim that it no longer had weapons of mass destruction, see Rajiv Chandrasekaran, "Iraq Seeks Meeting with UN Inspectors," *Washington Post*, March

In the days preceding the outbreak of hostilities, top Iraqi intelligence officials—almost certainly with Saddam’s concurrence—attempted to open a secret communication channel using a Lebanese-American businessman as an intermediary with the Bush administration to avoid war. Among other inducements, the Iraqis reportedly told their intermediary to tell his American contacts that Iraq would (1) allow U.S. troops and experts to conduct an independent search so as to prove that Iraq possessed no weapons of mass destruction, (2) hand over a man accused of being involved in the World Trade Center bombing of 1993 who was being held in Iraq, and (3) hold elections.⁴⁵

Even after hostilities commenced, Iraqi officials were appealing for diplomatic action to stop the coalition attacks. Vice President Taha Yassin Ramadan Al Jizrawi on March 23 called on the United Nations to intervene and halt the fighting. “Ramadan appealed to Arab governments to press for diplomacy. He and other officials appeared to take heart from footage of protests across the Arab world, and chastised Arab leaders for blocking antiwar demonstrations.”⁴⁶

Even if war could not be avoided, Saddam was apparently convinced that American forces would not invade Iraq.⁴⁷ According to a former senior Ba’ath Party member, Saddam was convinced that a show of force would be sufficient to deter an invasion as the United States would seek to avoid another Vietnam and the casualties that an invasion would entail.⁴⁸ Commenting on Saddam’s overconfidence about U.S. casualty sensitivity, Tariq ‘Aziz had the following exchange with his debriefer:

‘Aziz: A few weeks before the attacks, Saddam thought the U.S. would not use ground forces; he thought that you would only use your air force.

Debriefer: Wasn’t he aware of the buildup of forces in the region?

‘Aziz: Of course he was aware; it was all over the television screen. He thought they would not fight a ground war because it would be too costly to the Americans. He was overconfident. He was clever, but his calculations were poor. It wasn’t that

16, 2003, p. A14; Duelfer, pp. 63–64.

⁴⁵ See James Risen, “Baghdad Scrambled to Offer Deal to U.S. as War Loomed,” *New York Times*, November 5, 2003, and “Bush Aides Play Down Effort to Avert War at Last Minute,” *New York Times*, November 7, 2003.

⁴⁶ Anthony Shadid, “Iraqi Officials Emerge, Bolstered by U.S. Setbacks,” *Washington Post*, March 24, 2003, p. A21.

⁴⁷ See Mark Hosenball, “Iraq: What in the World Was Saddam Thinking?,” *Newsweek*, September 15, 2003, p. 8. Saddam’s views were reported to *Newsweek* by U.S. officials who were familiar with the accounts of Saddam’s thinking provided to American interrogators by some of the former Iraqi leader’s associates. Also see Duelfer, p. 31.

⁴⁸ Duelfer, p. 67.

he wasn't receiving the information. It was right there on television, but he didn't understand international relations perfectly.⁴⁹

Instead of an invasion, Saddam believed the most likely kind of attack President Bush would launch against Iraq would be a "low-risk bombing campaign" similar to that employed by the Clinton administration against Iraq in Operation DESERT FOX and against the former Federal Republic of Yugoslavia in Operation ALLIED FORCE.⁵⁰ Moreover, he believed that any bombing campaign would probably be short-lived, as France, Germany, Russia, and China would pressure the United States to "retreat from this course," and leave "Saddam still in power."⁵¹ Even after U.S. forces had assembled on Iraq's border with Kuwait, "Saddam recalling the first Gulf War, thought U.S. ground forces would only go after suspected unconventional weapons sites, SCUD missile launchers and military bases."⁵²

Finally, even if the United States were to invade Iraq, Saddam believed that Iraqi forces, using the strategy he had designed, would be able to force the United States to settle for a political solution that would leave his regime in place. In holding to this view, Saddam made several erroneous assumptions.

First, he assumed that the Iraqi military would be motivated and capable of mounting an effective protracted defense. Saddam was encouraged in this belief by senior officers and civilian officials throughout the chain of command who consistently and blatantly lied to him about the readiness and fighting will of the Iraqi armed forces.⁵³ A culture of lying to superiors had grown in the Iraqi officer corps during the 1990s, driven by fear of Saddam and his regime and by the inability of the military to achieve results as resources deteriorated under sanctions imposed by the United Nations.⁵⁴

Saddam was also deceived about the status of some of his longer-term weapons development programs. General Yasin Mohammad Taha Joubouri, a regular army artillery specialist, explained how he and his colleagues had systematically deceived Saddam about the status of a 210mm cannon the Iraqi leader had ordered them to build. Fully aware that the cannon they had designed would never work, Joubouri and the other artillery specialists assigned to work on the weapon nevertheless built a full-scale model of the nonfunctional weapon and submitted fake performance records to

⁴⁹ Quoted in Duelfer, p. 67.

⁵⁰ According to some Iraqi officials, Saddam believed the Desert Fox-type air strikes would be the "worst" form of pressure he could expect to undergo from the United States. See Duelfer, p. 49.

⁵¹ Hosenball, p. 8; Duelfer, pp. 32 and 49.

⁵² Hosenball, p. 8.

⁵³ Duelfer, p. 11.

⁵⁴ Duelfer, p. 11.

convince Saddam that the project was on track. As Joubouri described the situation: “No one could tell him it couldn’t work; . . . he was giving us awards and presents.”⁵⁵

Few officers or officials were willing to risk conveying to Saddam the true state of their unit’s morale and readiness. Even Saddam’s son Qusay, who had been trusted with the supervision of all Iraqi Republican Guard forces, was keen to provide Saddam with good news. Qusay “lived in fear of incurring Saddam’s displeasure and optimistically exaggerated information that he gave Saddam.” In late 2002, he audaciously boasted to his father, “we are ten times more powerful than in 1991.”⁵⁶

In the run-up to the war, Saddam met with numerous commanders of various Iraqi units. In each and every meeting there was a statement from the commander asserting that his unit was ready and willing to fight. The publicity often accorded these ritualistic ceremonies no doubt aimed to reassure the Iraqi public and deter military action by the United States.⁵⁷ But even in Saddam’s private meetings with his senior officers, similar expressions of resolve and readiness to fight were consistently tendered. Saddam no longer sought “ground truth” about the actual status of Iraq’s forces as he once had by visiting units and asking pointed questions. Instead, he relied on the reports from officers who deliberately misled him out of fear of losing their positions and even their lives.⁵⁸

Second, Saddam believed the Iraqi people would not stand to be occupied or conquered by the United States and would rise up and attack any American or other coalition invaders. According to the former minister of defense, Sultan Hashim Ahmad Al Ta’i, Saddam “thought that the people would, of their own accord, take to the streets and fight with light arms, and that this would deter the U.S. forces from entering the cities.”⁵⁹ Saddam’s mistaken conceit that the Iraqi population supported his regime—he had won a referendum on his rule by an overwhelming margin in 2002—apparently underlay this assumption.⁶⁰

Third, Saddam calculated that the robust defense he expected to be mounted by the Iraqi military and populace would exact an unacceptable level of U.S. casualties. He assumed that the specter of large numbers of American casualties and significant

⁵⁵ Moore, “A Foe That Collapsed from Within,” p. A1.

⁵⁶ Then the minister of military industrialization, Huwaysh, who was present at the meeting, claims that he immediately disagreed with Qusay, saying “Actually, we are 100 times weaker than in 1991, because the people are not ready to fight.” Huwaysh reports that Saddam did not respond but Qusay was angry because Huwaysh had contradicted him. Duelfer, p. 22.

⁵⁷ For a description of the Saddam-military meetings, see Neiel MacFarquhar, “Hussein, in Rallying His Military, Also Shows Iraqis a Defiant Face,” *New York Times*, March 7, 2005, p. 1.

⁵⁸ Duelfer, p. 11.

⁵⁹ Duelfer, p. 67.

⁶⁰ In this pseudo-election, every one of the nation’s 11.5 million eligible voters voted to keep Saddam as president. See “Ba’ath Party Entrenched in Saddam’s Cult of Personality,” *The China Post*, April 4, 2003.

U.S.-caused collateral damage would stimulate sufficient international and American domestic antiwar pressures to force the United States to halt its military action and negotiate a political solution.⁶¹

According to one senior Iraqi official, Saddam believed that Iraqi forces would be capable of holding off any U.S. invaders “for at least a month” and that U.S. forces would not penetrate as far as Baghdad.⁶² He may also have believed that even a short defense could force a political settlement. This expectation may explain why, just before the war began, Saddam told his generals to “hold the coalition for eight days and leave the rest to him.”⁶³ A former Iraqi general reports that Saddam, almost to the end of the 2003 conflict, clung to the belief that he could “solve the problem politically, as he had done at the end of the 1991 Gulf War.”⁶⁴

The U.S. withdrawals from Vietnam, Lebanon, and Somalia apparently convinced Saddam that the United States could not politically sustain a military involvement in which it suffered casualties. He had voiced such a view prior to the 1991 Gulf War. In his discussion with U.S. Ambassador April Glaspie prior to his invasion of Kuwait, Saddam asserted that America was a “society which cannot accept 10,000 dead in one battle.”⁶⁵ He later would boast to German television on December 20, 1990—shortly before hostilities commenced—that “We are sure that if President Bush pushes things toward war, once 5,000 of his troops die, he will not be able to continue the war.”⁶⁶

Finally, Saddam was apparently unconvinced that the United States really intended to overthrow him.⁶⁷ The United States had not marched on Baghdad in 1991 when it had the opportunity to do so after the rout of the Iraqi army in the Kuwait Theater of Operations (KTO).⁶⁸ He believed the United States would again see benefits in maintaining his rule and would stop short of a move on Baghdad. The extent of Saddam’s persistent illusions about U.S. intentions is summarized in the following

⁶¹ 3rd Infantry Division (Mechanized), p. xxii.

⁶² Duelfer, p. 62.

⁶³ Duelfer, p. 66.

⁶⁴ Paul Martin, “Iraqi Defense Chief Argued with Saddam,” *Washington Times*, September 21, 2003.

⁶⁵ “Excerpts from Iraqi Transcripts of Meeting with U.S. Envoy,” *New York Times*, September 23, 1990, p. 19.

⁶⁶ See *FBIS Trends*, FB TM 91-002, January 10, 1991, p. 2.

⁶⁷ Duelfer, p. 32.

⁶⁸ According to General Wafic Al Samarrai, the head of Iraqi military intelligence during the Gulf War, Saddam was “quite desperate and frightened” by the prospect of a coalition march on Baghdad following the rout of his army in the KTO, as he believed “his downfall was imminent.” When Saddam subsequently learned that President Bush had called for a ceasefire, his morale rose from “zero to 100.” Transcript of interview with General Wafic Al Samarrai, for an episode of the PBS program *Frontline* entitled “The Gulf War: An Oral History,” first aired January 9, 1996. As of August 2007, transcript begins at:

<http://www.pbs.org/wgbh/pages/frontline/gulf/oral/samarrai/1.html>

statement by the former director of the directorate of military intelligence, Staff General Zuhayr Talib ‘Abd-al-Satar:

Two to three months before the war, Saddam Husayn addressed a group of 150 officers. He asked why the Americans would want to come here. Why would they come here when they don’t need anything from Iraq? They have already fulfilled the goals that the military established in the first Gulf War. They wanted to occupy the Gulf States and look it has happened. Everyone except for Saddam Husayn, his children, and his inner circle, everyone else secretly believed that the war would continue all the way to occupation. Saddam and his inner circle thought that the war would last a few days and then it would be over. They thought there would be a few air strikes and maybe some operations in the south.⁶⁹

The Consequences of Saddam’s Strategic Misjudgments

Saddam’s misjudgments about U.S. intentions vis-à-vis Iraq following 9/11; the likely nature and scope of any U.S. attacks; and Iraq’s ability to mount an effective defense with the strategy at hand, importantly influenced Iraq’s political and military behavior in the run-up to and conduct of the 2003 war.

First, because he clearly misread the potential peril his regime faced after 9/11, Saddam failed to take the steps that might have helped fend off a U.S. attack. He missed an opportunity to cast Iraq in a better light when he dismissed suggestions from some of his ministers that he offer to “step forward and have a talk with the Americans,” and that in particular, he clarify that Iraq was “not with the terrorists.”⁷⁰ Prior to November 2002, Saddam made no substantive moves to convince the world that Iraq possessed no weapons of mass destruction. He still refused to accept UN Security Council Resolution 1284 or to allow UN weapons inspectors to return to Iraq.⁷¹

The conviction that the United States would not invade Iraq seems to have led Saddam to be more leisurely than he otherwise might have been in responding to Security Council Resolution 1441 that called on Iraq to “provide UNMOVIC and the IAEA [International Atomic Energy Agency] immediate, unimpeded, unconditional, and unrestricted access to any and all” Iraqi facilities and records they wished to inspect and persons they wished to interview.⁷² As Hans Blix points out, Iraq’s response to Resolution 1441 was a case of too little too late. Blix found it puzzling that

⁶⁹ Quoted in Duelfer, p. 66.

⁷⁰ Duelfer, p. 61.

⁷¹ Duelfer, pp. 61–62.

⁷² United Nations Security Council Resolution 1441 on Iraq, adopted on December 20, 2002.

the Iraqis did not do more, earlier to try to convince UNMOVIC that its WMD had been destroyed.⁷³

Second, Saddam's erroneous perceptions about the immediacy of the threat also help to explain why Iraq's preparations to fend off an invasion lacked a sense of urgency. Defensive measures were instituted, but the planning, organization, and implementation of the defense measures appeared to be confused, ad hoc, and last minute.

Third, misjudgments about the Iraqi ability to exact sufficient U.S. casualties to force a political settlement in the event of an invasion led Saddam to eschew adopting the more draconian defensive measures that might have made the invasion more difficult and costly for the coalition. Because he did not see his regime to be in mortal danger, he apparently did not see the need for scorched earth tactics, such as blowing up dams to flood likely invasion routes, or clouding Iraq's sky and denying Iraq's oil facilities to advancing enemy forces by setting them afire. Instead, the Iraqi strategy was to try to defend the oil facilities and dams. Saddam's reluctance to allow the systematic demolition of Iraq's bridges is also a manifestation of this complacency, as he apparently wanted bridges kept intact to facilitate Iraqi counterattacks and preserve valuable infrastructure. It seems likely that the rationale for disassembling aircraft and hiding them in fields or burying Iraqi jet fighters in the sand was the expectation that they would be needed again following a political settlement.⁷⁴

Finally, erroneous beliefs about U.S. casualty sensitivity and Iraqi military capabilities and morale probably hardened Saddam's determination not to consider defensive options (such as the deployment of Republican Guard heavy divisions in Baghdad) that might have increased the threat of a military coup against his person and regime.

Saddam's Internal Security Concerns Weakened Iraqi Defenses Against External Attack

Saddam's preoccupation with internal threats also importantly shaped Iraq's defensive posture. While Saddam believed that much of the Iraqi military and populace would fight to defend Iraq, he trusted neither as far as his own personal security and that of his regime was concerned. His caution was based on hard experience, since he had been the target of multiple uprisings, coups, and assassination attempts during the course of his rule.⁷⁵ As a result of his preoccupation with his personal and regime secu-

⁷³ Among the actions Blix found puzzling was why the Iraqis were "so late in presenting UNMOVIC with lists of people who they claimed had taken part in the destruction of prohibited items in 1991? Why did they not present these people for interviews in December 2002?" See Blix, p. 240.

⁷⁴ Moore, "A Foe That Collapsed from Within," p. A1.

⁷⁵ According to the testimony of 'Abd-al-Tawab 'Abdallah Al Mullah Huwaysh, deputy prime minister and minister of industrialization, the serious wounding of Uday had a particularly deep impact on Saddam because the

rity, he imposed extreme security measures and shaped his security forces with an eye to forestalling coups rather than defending the country.

To foil direct attacks on his person, Saddam adopted a number of extreme security measures. To forestall being targeted by the United States for an air attack, Saddam avoided the use of potential emitters and moved frequently.⁷⁶ He abandoned the use of headquarters facilities, conducted business from a variety of ever-changing safe houses in residential areas, and limited the information about his location and planned movements to a very small circle of trusted assistants and bodyguards, virtually all of whom were family or fellow tribal members.

Saddam's meetings with his cabinet ministers, members of the RCC, and other groups were usually called on short notice and were held in safe houses at undisclosed locations. Attendees were collected by official cars, driven to a pickup point, and then switched to different vehicles with blacked-out windows for the trip between the pickup point and the meeting place.⁷⁷ These procedures continued to be followed during OIF.

Iraq's Forces Were Shaped to Forestall Coups, Uprisings

The prevention of coups and uprisings was also an overriding concern of Saddam's. As a consequence, many of the personnel, organizational, command and control, and deployment measures and policies that shaped and governed Iraq's military and security forces were designed more for forestalling coups and uprisings than for defending the country against foreign invasion. Saddam, distrusting his military commanders and elements of the Iraqi population, enacted measures and policies to constrain their motivation and ability to move against him.

First, Saddam routinely gave his senior commanders cash bonuses, new cars, Rolex watches, and the like to encourage their loyalty and dependence on his largesse. At the end of the pep talk meeting Saddam held with 150 of his general officers four days prior to the war, for example, Saddam's aides handed each general a cash gift of 1 million dinars, equivalent to about \$5,000.⁷⁸

Second, Saddam appointed members of his immediate and extended family and members of his Tikriti clan to key military positions and battlefield commands. In doing so he was quite willing to sacrifice military experience and competency for assured loyalty. Among the most notorious recipients of such appointments were Sad-

security procedures and "extensive infrastructure designed to protect him and his family failed in a spectacular and public way." See Duelfer, p. 21.

⁷⁶ Saddam's personal security was the responsibility of the presidential bodyguards, Special Security Organization (SSO) security units, and the Special Republican Guard elements. Saddam's food was tested in a laboratory operated by the SSO. See Duelfer, p. 21.

⁷⁷ Duelfer, p. 12.

⁷⁸ This according to General Kareem Saadoun, an air force commander who attended both meetings. Moore, "A Foe That Collapsed from Within," p. A1.

dam's sons. Neither of his sons, Qusay and Uday, had any significant military training or service, but both supervised important military forces, the Republican Guard and the Fedayeen Saddam. Increasingly, command positions at the corps and division level were filled by officers of marginal competence who were members of the Tikriti clan or Saddam's extended family.

Third, to inhibit the leaders of any single military institution from gaining a monopoly of power that might encourage them to challenge his rule, Saddam established a multiplicity of competing military and militia organizations. The most prominent of these were the regular army, Republican Guards, Special Republican Guards, Fedayeen Saddam militia, Ba'athist militia, and the Al Quds Army militia.⁷⁹ Each organization had a separate chain of command that invariably ended with Saddam. Cooperation between these organizations was officially discouraged and strictly controlled.

Fourth, Saddam embedded intelligence and Ba'ath Party personnel within Iraqi military organizations to monitor officers and troops. Ba'athist political officers were emplaced in the senior echelons of Iraqi divisions to ensure loyalty and compliance with Baghdad's orders. Officers of the Directorate of General Military Intelligence were assigned to each military unit down to battalion level to monitor troops and control corruption. The Special Security Organization (SSO), commanded by Qusay, embedded security officers down to battalion level within Republican Guard units.⁸⁰

Fifth, Saddam and his headquarters' staffs kept an extremely tight rein on the actions of the Iraqi corps, division, and subordinate commanders. To discourage untoward collusion between military units, commanders were forbidden to interact with neighboring units not under their direct chain of command without explicit authorization. In addition, Republican Guard and regular army units and equipment could not be moved without the explicit prior permission of Baghdad.⁸¹ No regular army or Republican Guard units were deployed in or allowed to enter Baghdad.

Finally, to deter and uncover potential uprisings, Saddam's security operatives and Ba'ath Party officials maintained extensive informant nets within the Iraqi population centers to monitor possible anti-regime behavior. In the event of uprisings in

⁷⁹ The Al Quds Army was a civilian militia organized by Saddam in 2001 "in theory to prepare for an invasion of Israel" (Al Quds is the Arabic name for Jerusalem). But as war with the United States became imminent, homeland defense became its primary role. The Iraqi government claimed the militia had 7 million members, but Western analysts put the number at closer to 1 million. The militia members received little training and were lightly armed. See Rajiv Chandrasekaran, "Iraq Arms Civilians as Second Line of Defense Against U.S.," *Washington Post*, February 5, 2003, p. A1.

⁸⁰ See Duelfer, pp. 83 and 89.

⁸¹ In the case of the Republican Guard, some of whose forces were closest to Baghdad, "no piece of military equipment could be moved—even for repair—by brigade, division, or corps commander without the prior written permission of Qusay through the RG Secretariat." Duelfer, p. 93.

Baghdad, security was to be restored by Saddam Fedayeen and Ba'athist militias, local police forces, and SSO security elements.⁸²

The measures Saddam instituted to ensure his personal security and to fortify his regime against coups and uprisings had several consequences. First, Saddam's personal security measures made a successful decapitation strike against him very problematic. Second, the U.S. hope that the "shock and awe" created by the bombing of dozens of key targets simultaneously would cause Saddam's regime to "crumble" would go unrealized.⁸³ Saddam and his colleagues expected such air attacks and prepared for them by avoiding facilities likely to be targeted. The air campaigns in DESERT STORM and DESERT FOX had sensitized Iraqi military and civilian leaders to the types of targets the United States was likely to attack. As a consequence, the 50 attacks on time sensitive leadership targets in Iraq during OIF produced zero kills of the targeted personages.⁸⁴ Third, the measures Saddam adopted to ensure his personal security almost certainly degraded his situational awareness and ability to command and control Iraqi forces in a timely manner. Finally, Saddam's preoccupation with internal threats undoubtedly weakened Iraqi capabilities to counter a conventional invasion such as occurred in OIF. As discussed below, actions to fortify his regime against coups and uprisings compromised the adoption of an effective Iraqi defensive strategy, degraded the quality of military leadership and decisionmaking, and undermined the coordination and unity of command of the Iraqi forces.

Iraqi Military Strategy and Operations Were Poorly Designed and Executed

Saddam's strategic miscalculations and the policies and practices that flowed from his preoccupation with internal threats significantly degraded the Iraqi defense in OIF. Indeed, the Iraqi leader's perceptions, decisions, and practices explain in large measure why the Iraqi resistance against OIF was so poorly planned and led. The pernicious effects of these shortcomings were compounded by the fact that Iraqi units lacked situational awareness, were inadequately trained, and were equipped with weaponry that was decidedly inferior to that of the coalition.

⁸² A battalion-sized SSO security unit was responsible for the security of strategically important roads around Baghdad and Tikrit. Duelfer, p. 92.

⁸³ U.S. Secretary of Defense Donald Rumsfeld expressed interest in designing a bombing campaign that would "put very rapid, very quick pressure early on" that might cause Saddam's regime to crumble. See Woodward, pp. 75, 76, 110.

⁸⁴ See statement by Marc Garlasco, a DIA analyst from 1997 to 2003, for an episode of the PBS program *Frontline* entitled "The Invasion of Iraq," first aired February 26, 2004. As of August 2007: <http://www.pbs.org/wgbh/pages/frontline/shows/invasion/etc/script.html>

As noted earlier, Saddam believed the United States would limit its military attacks on Iraq to bombing and would not invade the country because of the casualties an invasion would entail. However, in the event of an invasion, the overall Iraqi political-military strategy was to protract the conflict, maximize U.S. casualties, and publicize the humanitarian costs of the conflict and thereby create U.S. domestic and international pressures for a negotiated solution that would allow Saddam's regime to remain in place.⁸⁵

The defensive scheme Saddam adopted to execute this overall strategy focused on the defense of Baghdad and other major Iraqi cities. The strategy called for: (1) regular army forces to defend forward, impede any coalition advance toward Baghdad, and protect the major cities in northern and southern Iraq; (2) Republican Guard forces (eventually reinforced by some regular army units) to defend the approaches to Baghdad; and (3) paramilitary forces to suppress any anti-regime uprisings and counter any enemy incursions in Baghdad or other cities.⁸⁶

Even on the eve of conflict, the bulk of Iraq's regular army divisions remained in the vicinity of their prewar deployment areas. In northern Iraq, ten regular army mechanized and infantry divisions remained facing the Green Line, the de facto border within Iraq separating Kurdish-controlled territory from Iraqi government-controlled territory.⁸⁷ These units were responsible for countering any enemy attacks from the north and northeast and for protecting the important cities of Mosul and Kirkuk.

Six regular army armored, mechanized, and infantry divisions were deployed to defend southern Iraq.⁸⁸ As subsequent discussion will show, the positioning of this force was heavily weighted to the east, paralleling the Iraq-Iran border.

As the seat of power, Baghdad was accorded Iraq's strongest defenses. Saddam deployed his six Republican Guard divisions (three armored, one mechanized, and two infantry) in a cordon around Baghdad, with particular emphasis on defending the southern approaches to the city.⁸⁹

⁸⁵ See Duelfer, p. 68.

⁸⁶ As we have seen, this plan failed completely except that there is some evidence that the Fedayeen Saddam did attempt to stiffen the spine of reluctant soldiers. See Chapter Four for details on ground combat operations.

⁸⁷ The units defending along the Green Line were the 1st and 5th Mechanized Divisions and the 2nd, 4th, 7th, 8th, 15th, 16th, 34th, and 38th Infantry Divisions. The 3rd Armored and 34th Infantry Divisions were situated below the southern end of the Green Line along the border with Iran. The Republican Guard Adnan Mechanized and the Nebuchadnezzar Infantry Divisions that normally had been positioned in the north, were moved down to the Baghdad area to strengthen the defense of the capital. Other Iraqi divisions were also moved south during the course of the war. See Fontenot, Degen, and Tohn, pp. 100, 212, 248, 252, 263, 296, 301, and 330; and CFLCC, "Intelligence Update," 23 March 2003, 0300Z.

⁸⁸ The units defending southern Iraq were the 6th and 10th Armored Divisions, the 51st Mechanized Division, and the 11th, 14th, and 18th Infantry Divisions. See Fontenot, Degen, and Tohn, pp. 100–101, and CFLCC, "Intelligence Update," 23 March 2003, 0300Z.

⁸⁹ The Republican Guard forces were the Al Nida, Hammurabi, and Medina Armored Divisions, the Adnan Mechanized Division, and the Baghdad and Nebuchadnezzar Infantry Divisions.

Saddam's plan for the defense of Baghdad purportedly called for the preparation of two concentric defensive belts. The outermost of the circular belts was to be as much as 100 kilometers from the center of the city.⁹⁰ The Republican Guard forces were to be positioned initially in the outer defensive circle and, if hard pressed, were to retreat to the inner, "Red" defensive belt where they would fight to the end. Under Saddam's defensive scheme, the task of engaging any enemy troops who might penetrate into the cities was to fall primarily on Iraqi paramilitary forces. These paramilitary units were to perform the even more important mission, from Saddam's standpoint, of deterring and, if need be, suppressing any anti-regime uprisings in the urban areas.⁹¹

To ensure public order and provide for the internal defense of Baghdad, Saddam organized and positioned thousands of Saddam Fedayeen and Ba'ath Party militia-men inside the city. Three Special Republican Guard brigades were also positioned in Baghdad both to counter any incursions or uprisings and to provide area security for Saddam and protect his palaces.⁹²

Saddam took two other actions to deter possible popular uprisings. First, he directed his intelligence services and Ba'athist leaders to closely monitor the populations in their local areas. Second, he directed that the principal urban areas be provided with sufficient supplies of food to withstand protracted bombing or sieges by ground forces.

The operational strategy that Saddam adopted to meet the coalition invasion did little to provide effective support to his overarching political-military strategy of protracting the conflict, maximizing U.S. casualties, and thereby creating pressures for a negotiated solution that would leave his regime in place. Indeed, the defensive scheme he adopted hastened the Iraqi defeat and failed to exploit potential options for protracting the conflict and maximizing coalition casualties.

The flaws in the Iraqi operational strategy appear to be attributable to Saddam's congenital optimism, lack of military acumen, and failure to absorb the lessons of DESERT STORM; his misjudgments about coalition intentions, vulnerabilities, and likely courses of action; his misperceptions about the military capabilities and fighting will of his own forces; and his overriding concern to fend off internal threats to his

⁹⁰ The brigadier general who commanded Baghdad's missile air defense told an interviewer that "the defense of Baghdad was planned with two belts of army defenders, one set 100 kilometers from the city, the other at 50 kilometers." See Robert Fisk, "Ruling the Airwaves—How America Demoralised Iraq's Army," *The Independent* (UK), May 27, 2003.

⁹¹ According to an analysis of Iraqi prisoner interrogations compiled by the U.S. Joint Forces Command, Saddam was so convinced that war could be averted or that the United States would only attack Iraq with a limited bombing campaign that he deployed Iraqi forces to crush possible domestic uprisings rather than to defend against external attacks. See the discussion of the Joint Forces Command report, "Iraqi Perspectives on O.I.F. Major Combat Operations," in Thom Shanker, "Regime Thought War Unlikely, Iraqis Tell U.S.," *New York Times*, February 12, 2004. Also see 3rd Infantry Division, 2003, pp.xxii–xxiii.

⁹² The Special Republican Guards, which probably numbered about 15,000 troops, were the only Iraqi forces that had received training in urban warfare. Fontenot, Degen, and Tohn, p. 79.

person and regime. The strategy was also the product of Iraq's dated military doctrine and the climate of fear that deterred any disagreement with Saddam's decisions from the cowed general officers and senior officials who populated the higher echelons of the Iraqi defense establishment.

Most of the Iraqi divisions in southern Iraq were not well positioned to meet an invasion from Kuwait. Even after OIF was under way, the bulk of the regular army divisions in southern Iraq (including the 10th and 6th Armored Divisions, 51st Mechanized Division, and the 14th and 18th Infantry Divisions) remained positioned to defend the Highway 6 (Tigris River) approach toward Baghdad.⁹³ Highway 6 was only one of several routes of march to the capital, and it was by no means the most likely to be chosen by the coalition. The orientation along Route 6 also maintained these forces near their normal deployment areas paralleling the Iraq-Iran border and probably reflected Saddam's concern that Iran might attempt to militarily exploit a coalition air or ground attack.⁹⁴

Whatever the reason, the continued deployment of the regular army armored and infantry divisions along the Highway 6 corridor near the Iran border left the door open for coalition advances further west on Highways 8 and 7, the western Euphrates River approach to Baghdad, which had far fewer forces defending them. These forces were limited to a brigade of the 18th Infantry Division that was positioned to defend the Rumaila oil field, a regular army mechanized infantry brigade, and elements of two regular army armored brigades. The regular army's 11th Infantry Division also defended further north along the approaches to An Nasiriyah.⁹⁵

The unbalanced force dispositions in southern Iraq were undoubtedly part of the reason coalition commanders concluded that "Saddam had not positioned his forces to counter a ground assault."⁹⁶ As one history of the war put it: "When the coalition's invasion began, Iraqi forces were in none of the places they should have been to be militarily effective."⁹⁷

An important consequence of a military strategy that directed Republican Guard and regular army divisions to defend outside Iraqi cities was that it made those divisions extremely vulnerable to piecemeal destruction by U.S. air and ground forces. Indeed, the placement of Iraqi forces exterior to Baghdad was far more to the liking of U.S. commanders than was the prospect of an urban fight in a "Fortress Baghdad,"

⁹³ Fontenot, Degen, and Tohn, pp. 99–101. Also see CFLCC, "Intelligence Update."

⁹⁴ Iraqi ground forces had remained oriented toward the Iran border after DESERT STORM. See Duelfer, p. 29.

⁹⁵ See Fontenot, Degen, and Tohn, pp. 99–101.

⁹⁶ See Woodward, p. 402.

⁹⁷ See Williamson Murray and Robert H. Scales, Jr., *The Iraq War*, Cambridge: Harvard University Press, 2003, p. 96.

which President Bush and other U.S. leaders feared could prove both time-consuming and costly in American lives.⁹⁸

Some senior Iraqi generals voiced deep concerns about the survivability of any forces concentrated outside the cities. Lieutenant General Raad Al-Hamdani, the II Corps Republican Guard commander responsible for defending the southern approaches to Baghdad, worried greatly about the likely effects of American air power, even though his Republican Guard divisions had prepared thousands of alternative fighting positions to reduce their vulnerability to air attack.⁹⁹

Other Iraqi officers also disagreed with Saddam's deployment scheme. Major Jaburi, a 2nd Infantry Division battalion commander, said that the decision to deploy Republican Guard forces south of Baghdad at Karbala, Hillah, and Al Kut made them easy targets for coalition strike aircraft. According to Jaburi, the Republican Guard units were particularly vulnerable to American air attack while they were moving, which cost them a lot of men. In Jaburi's view, "It was very easy for the Americans to enter Baghdad."¹⁰⁰

Urban warfare can be time-consuming and costly in casualties. However, Saddam's military strategy excluded measures that could have made Baghdad and other Iraqi built-up areas more difficult and costly to subdue. The decision to fight Republican Guard and regular army units outside the cities obviously reduced their potential for mounting a later defense within urban areas. Saddam apparently did not believe such a step was necessary. He naively assumed that Iraq's lightly armed Fedayeen and Ba'ath Party militia forces, along with the local Al Quds Army militia and the numerous tribal elements that he had armed shortly before the war, would be able to mount an effective, high-casualty-producing resistance against any coalition forces that penetrated the urban areas.

⁹⁸ General Franks had developed an "Inside-Out" concept for preventing outlying Iraqi regular army or Republican Guard divisions from coming back into Baghdad: "Instead of attacking from the outside of the defensive cordon around the capital, we would destroy the enemy inside the cordon by relentless air attack, working from the center outward. The more concentrated the Republican Guard positions were, the more vulnerable they became. And attacking in and around Baghdad had the added benefit of making the city 'inhospitable' to forces looking for a place to hide." See Franks, p. 391, and Woodward, pp. 126, 135–136, 147, 206, and 208.

⁹⁹ General Al-Hamdani's preferred strategy was to deploy Iraqi forces in small increments far away from the cities and to declare Baghdad an open city to prevent its destruction. How this strategy would have preserved Saddam's regime is unclear. According to Al-Hamdani, "Even if the enemy entered [Baghdad], that would not mean anything. There should be no headquarters in it, and no major state administration organization, so that the enemy would be compelled to look for his opponents in all directions. The war would become unclear, and the enemy would not be able to say that he had attained his objectives. This is because he had to attain his objective on the scale of Iraq, which is a relatively large country, by Middle East standards." See *Frontline* interview with Lieutenant General Al-Hamdani.

¹⁰⁰ Scott Peterson and Peter Ford, "From Iraqi Officers, Three Tales of Shock and Defeat," *Christian Science Monitor*, April 18, 2003, pp. 1 and 12.

Urban warfare was simply not part of Iraqi military doctrine, and none of the Republican Guard or regular army forces were trained for city fighting. According to Stephen Biddle, the regular army and Republican Guard commanders his team interviewed found the entire concept of city fighting unthinkable. Biddle quoted one Iraqi colonel as saying: “Why would anyone want to fight in a city? Troops couldn’t defend themselves in cities.”¹⁰¹

Saddam’s concern to keep potential coup-prone military units at a distance from his seat of power was a major barrier to the deployment of Republican Guard and regular army divisions inside Baghdad. This undoubtedly was a key reason that Saddam purportedly rejected a plan attributed to his defense minister, General Sultan Hashim Ahmad al-Tai, to “put up ‘a powerful defense’ through urban warfare in and around Baghdad.” General al-Tai would have surrounded Baghdad with huge numbers of land mines and ringed the city with T-72 tanks.¹⁰²

Effective defense within the cities was further hampered by the near absence of fixed defenses or barricades that would have created strong fighting positions from which Iraqi defenders could have impeded the advance of coalition armor and infantry. A survey of Iraqi defenses in Baghdad found no defensive preparations such as barricades, wall reinforcement, loophole construction, or wire entanglements in the interiors of buildings and few, if any, obstacles, minefields, and barriers on the streets.¹⁰³

Even though the Iraqi strategy was to impede the coalition march toward Baghdad, measures that could have slowed the advance—such as the systematic mining of roads, destruction of bridges, and flooding of choke points—were not part of the Iraqi defense scheme. Former Iraqi military leaders attributed Saddam’s failure to prepare land mines and other basic military measures to block or slow the U.S. advance to the Iraqi president’s military incompetence, isolation, and overreliance on family and tribe.¹⁰⁴

Permission to drop bridges could only be granted by Baghdad headquarters, and Saddam, misperceiving the military situation, failed to order their systematic demoli-

¹⁰¹ See prepared testimony of Dr. Stephen Biddle, Associate Professor of National Security, U.S. Army War College Strategic Studies Institute, before the House Armed Services Committee. Dr. Biddle and his team conducted a study of OIF and its implications for American defense policy for the U.S. Army Deputy Chief of Staff, G-8. The study was based on a series of 176 interviews with U.S., British, and Iraqi regular army and Republican Guard participants in the conflict, primary source materials relating to the conduct of the war, and direct physical inspection of some of the war’s key battlefields. See U.S. House of Representatives, *Statement of Dr. Stephen Biddle, Hearing of the House Armed Services Committee*, Washington, D.C.: GPO, October 21, 2003, footnote 1.

¹⁰² As described by an unidentified general officer, General al-Tai’s plan was to defend Iraq by forcing invading forces to engage in urban combat. His battle plan would have included the deployment of troops in small groups of fighters and, by drawing out the battle, would have aimed to make the coalition advance on the capital slow and painful. General al-Tai believed that “neither Bush nor Blair could handle the political pressure at home if [many] soldiers were dead.” See Martin.

¹⁰³ U.S. House of Representatives, *Statement of Dr. Stephen Biddle*.

¹⁰⁴ See Coll, p. A1.

tion. Former Iraqi commanders report that Saddam was so convinced that the Republican Guard units deployed south of Baghdad would be able to repel U.S. armor attacks that he decided not to mine the highways or blow up the bridges leading to the capital.¹⁰⁵

As a consequence, nearly all the key bridges along the lines of the coalition's advance and the bridges and causeways within or leading into Baghdad, Basra, and other urban centers were captured intact.¹⁰⁶ Some were prepared for demolition but not blown, others were not even wired.¹⁰⁷

If Saddam saw no need for systematic mining of roads or destruction of bridges, he was obviously unwilling to entertain the even more drastic option of breaching dams and dikes to flood the lower Tigris and Euphrates river valleys and the other potential choke points along the coalition line of march. Coalition commanders worried about such contingencies and were particularly concerned that the Iraqis might blow the Hadithah Dam, which contained the waters of a huge reservoir immediately north of the Karbala Gap. Had the dam been breached, the resulting flood would have made an armored movement through the gap impossible.¹⁰⁸

While the coalition did not plan to rely on the Iraqi port of Umm Qasr for the logistical support of their invasion forces, the Iraqis did not know that. They had an option to block and delay the coalition's use of the port by sinking ships in its harbor and destroying its handling facilities. Even though the Iraqis held the port for days before its capture, coalition forces captured it intact.¹⁰⁹

Coalition planners worried that Saddam would react to an invasion by systematically torching the country's oil wells and destroying its production facilities. The concern was so great that forces were inserted into Iraq's southern Rumaila oil field at the outset of the conflict to prevent such destruction.

¹⁰⁵David Zuchino, "Iraq's Swift Defeat Blamed on Leaders," *Los Angeles Times*, August 11, 2003, p. 1.

¹⁰⁶Thomas Ricks of the *Washington Post* recalls people at the Pentagon telling him about the Iraqi military:

Sure, their infantry kind of stinks, and their tanks are old. But they've got good engineers, and they're going to blow the bridges. Very few bridges across those rivers were actually blown. Actually, there were a lot of smaller bridges across canals, because that area between the rivers is just chock-a-block with canals. It could have been a real nightmare for the U.S. military, even if just the engineers had been out blowing up bridges, mining choke points between the canals. And not a lot of that happened.

From transcript of interview with Thomas E. Ricks, conducted January 28, 2004, for an episode of the PBS program *Frontline* entitled "The Invasion of Iraq," first aired February 26, 2004. As of August 2007: <http://www.pbs.org/wgbh/pages/frontline/shows/invasion/interviews/ricks.html>.

¹⁰⁷The charges under one bridge were detonated, but the bridge failed to collapse. See Murray and Scales, pp. 205–206.

¹⁰⁸The gap to the west of Karbala was the only feasible route of advance, since the area to the east of Karbala and around the Euphrates River crossing was a "nightmare of bogs and obstacles." Murray and Scales, pp. 203–204.

¹⁰⁹U.S. House of Representatives, *Statement of Dr. Stephen Biddle*.

As it was, Saddam apparently saw no reason to destroy Iraq's precious petroleum infrastructure. There is no evidence the Iraqi leader made preparations for any systematic destruction of Iraq's oil fields. Iraqi forces maintained control of the Kirkuk fields in northern Iraq for more than three weeks after the invasion began, yet none of the Kirkuk wells and other oil facilities in the area were destroyed or even wired for demolition.¹¹⁰

Another major flaw in the Iraqi military strategy was the failure to focus attacks on the coalition's LOCs and thin-skinned supply vehicles. The fast-moving coalition combat forces depended on extended supply lines through areas that had not as yet been fully cleared of enemy forces. However, the Iraqis apparently had no plan and made little or no attempt to interdict those lines of supply by having militia and other forces attack the thin-skinned tankers and other supply vehicles supporting the U.S. advance. Instead, the militia forces were directed to attack U.S. combat elements, particularly the tanks and APCs leading the U.S. advance.

Aside from being poorly planned, the Iraqi defense operations in OIF were also poorly managed and executed. These shortcomings resulted from the Iraqi forces' (1) inept leadership, (2) dysfunctional command arrangements and practices, (3) poor situational awareness, (4) malpositioning on the battlefield, (5) poor training, and (6) obsolete and inferior equipment.

Iraq's poor battlefield performance in OIF can be traced in part to the military incompetence of the country's top military and civilian leaders. As previously noted, neither Saddam nor his immediate subordinate battlefield commanders had any military training or experience. Iraqi military officers who prided themselves on being professionals bemoaned their country's fate because it lay in the hands of a military naïf and incompetent whose ill-considered decisions and adventures had led their nation and military establishment to one disaster after another. A regular army colonel described the results of Saddam's decisionmaking as follows: "We are already used to his mistakes from the Iran-Iraq war and Kuwait . . . Every plan of Saddam was a disaster."¹¹¹

The pernicious effects of this absence of professionalism at the top echelons of the Iraqi chain of command were intensified by the fact that Saddam and his immediate subordinates exercised fine-grained control over military operations in Iraq. Baghdad controlled the demolition of bridges and the subordination and positioning of military units. Indeed, even Iraqi corps commanders lacked the authority to move their units or blow bridges without the prior approval of Baghdad. Baghdad sometimes ordered the movement of units and even whole divisions without the knowledge or approval of the local corps commander.

¹¹⁰ Some 22 Rumaila wells had been prepared for demolition but only nine were actually detonated, resulting in only seven fires. See U.S. House of Representatives, *Statement of Dr. Stephen Biddle*.

¹¹¹ Peterson and Ford, pp. 1 and 12.

Saddam's fear of military coups led him to direct that no significant armored or infantry element could be moved without the explicit permission of headquarters.¹¹² All decisions had to come from the top down. One consequence of this top-down decision process was that sometimes no decisions came down from Baghdad.¹¹³ Because each of Iraq's rival forces responded only to directives from on high, commanders were paralyzed with indecision in the absence of orders from the regime leadership. As one Republican Guard general put it: "Initiative was discouraged . . . no one dared to make decisions."¹¹⁴

The Iraqi command arrangements to meet the coalition attack were last minute and disruptive to the Iraqi military's normal chains of command. Perhaps because he still thought a war might be avoided, Saddam waited until mid-March, barely a week before the onset of OIF, to put in place a new, overall command structure, which included stripping units from their normal headquarters and attaching them to others, for the defense of Iraq. He divided the country into four separate regional commands, each, as previously mentioned, to be headed by leaders of proven loyalty but little if any military competence. The imposition of this new command arrangement not only diminished the quality of Iraq's battlefield leadership but also displaced the existing chains of command between the corps commanders and Baghdad. The Republican Guard II Corps commander believed that from a "military strategic point of view, dividing the country into four separate commands . . . was a strategic mistake."¹¹⁵

Saddam's paranoia about coups and other internal threats undermined the Iraqi defensive forces' unity of command and diminished their ability to coordinate on the battlefield. The diverse force structure that Saddam had deliberately created to fend off any common action against his regime militated against unity of effort. The fact that the regular army, Republican Guard, Special Republican Guard, Fedayeen Saddam, Ba'ath militia, and Al Quds Army had their own, separate chains of command and rarely, if ever, interacted with each other inevitably segmented and weakened the Iraqi defensive effort.¹¹⁶

¹¹²According to the Duelfer report, "No piece of military equipment could be moved—even for repair—by a [Republican Guard] brigade, division, or corps commander without the prior written permission of Qusay through the RG Secretariat." Duelfer, p. 93.

¹¹³Some officers reported receiving no orders during the entire duration of OIF. For example, Colonel Diar Abed, a wing commander at Rashid Air Base in southern Baghdad, stated that his unit "had no orders . . . We just stayed in the base and waited. I thought, 'I am losing my country, why don't they give us orders?' The leaders at the base didn't know anything." See Moore, "A Foe That Collapsed from Within," p. A1.

¹¹⁴Zucchini, "Iran's Swift Defeat," p. 1.

¹¹⁵*Frontline* interview with Lieutenant General Al-Hamdani.

¹¹⁶As the Republican Guard II Corps commander, Lieutenant General Al-Hamdani described it:

Each level of command was planning for itself. There was no harmony, only artificial coordination; but in fact there was no joint battles. Each level was fighting with his own plans, in a separate way, but within the general

The Iraqis had ample warning that a coalition attack was about to commence in March. Iraqi military and civilian leaders had followed the buildup of coalition air and ground forces in Kuwait through their intelligence sources and the accounts of coalition preparations reported in the print media, on television, and on the Internet.¹¹⁷ They realized that an attack was imminent when the UN inspectors were withdrawn from Iraq and the UN observers monitoring the Kuwait-Iraq border were also withdrawn.

According to the testimony of a senior Iraqi IIS official, from August 2002 to early January 2003 the Iraqi military had accelerated defensive measures to prepare for an anticipated U.S. attack. These measures included the moving and hiding of military equipment and weapons. Army commanders “at bases throughout Iraq were ordered to identify alternative locations and to transfer equipment and heavy machinery to off-base locations, taking advantage of farms and homes to hide items.”¹¹⁸ Ammunition stocks were also extensively dispersed. As war came closer, divisions moved out of their normal garrisons to survival positions.

Saddam’s understanding of the threat confronting his regime remained cloudy even after the start of hostilities. He apparently continued to believe, even up to the first days of April, that Iraqi forces would put up a defense sufficient to force some kind of political settlement.¹¹⁹

The persistence of this misperception was due in part to Saddam and his colleagues in Baghdad having only a limited grasp of what was transpiring on the Iraqi battlefield. The Baghdad headquarters staff reportedly was able to provide scant information on coalition operations to subordinate commands. Most tellingly, the deployment decisions emanating from Saddam, which will be discussed below, reflect a gross misreading of the coalition’s threat and lines of advance.

Subordinate battlefield commanders also exhibited very poor situational awareness. Division commanders only discerned the arrival of U.S. forces when their own units made contact. Iraqi commanders believed that U.S. air assault landings had taken place, when none had occurred, and that the U.S. 4th Infantry Division was in Iraq, when it was not. Many Iraqi general officers, believing that coalition forces were

view of the command. The regular army, Republican Guard, Quds Army, and Ba’ath Party militias were all fighting in a separate pattern, as if there [were] no unified armed forces.

See *Frontline* interview with Lieutenant General Al-Hamdani. Major General Abed Mutlaq Jubouri, a former division commander who had been jailed by Saddam for conspiring against the regime, also emphasized the absence of cooperation: “There was no unity of command. There were five different armies being used, no cooperation, no coordination.” See Coll, p. A1.

¹¹⁷ A field-grade Republican Guard officer stated that Iraq also “collected reliable tactical intelligence against U.S. forces in Kuwait and even knew when Operation Iraqi Freedom would start.” One senior officer underlined “how important the Internet was to their understanding of general threat capabilities.” See Duelfer, p. 32.

¹¹⁸ Duelfer, p. 65.

¹¹⁹ Martin.

bogged down in southern Iraq, admitted to being shocked when U.S. troops entered Baghdad.

Several reasons seem to explain this poor situational awareness:

- The sources on which the Iraqi leaders depended for most of their intelligence—the non-Iraqi media and the Internet—provided only limited and largely dated information on U.S. troop movements and operations.¹²⁰
- Because of U.S. air supremacy, no Iraqi aircraft flew in OIF. Without an aerial surveillance and reconnaissance capability, the Iraqis had difficulty gauging the depth, strength, and direction of march of the attacking U.S. formations.
- The countermeasures Saddam and other Iraqi leaders adopted to reduce the threat of air attacks to their persons and headquarters' staffs undoubtedly reduced their situational awareness.
- The “culture of lying” seems also to have carried over to the battlefield. Iraqi commanders were still wary about conveying “bad news” to Baghdad.¹²¹ The Republican Guard Nebuchadnezzar Division commander, for example, said that he continuously passed false information on to Qusay, the Republican Guard overseer: “We pretended to have victory, and we never provided true information as it is here on the planet earth. Qusay always thought he'd gain victory. Any commander who spoke the truth would lose his head.”¹²²
- The U.S. “joint campaign was so decisive and so fast [in] getting to Baghdad that the regime's situational awareness was destroyed.” This was the view of Lieutenant General David McKiernan, Commander, 3rd Army and CFLCC.¹²³

Coalition deception operations also may have contributed to the Iraqis' poor situational awareness, but this is difficult to document.

Whether because of poor situational awareness, mass desertions, strategic miscalculation, or command ineptitude, Iraqi forces were in crucial instances not well positioned for an effective defense. As previously discussed, Iraqi regular army forces were not positioned to meet an invasion from Kuwait at the onset of OIF. But malpositioning was evident in later stages of the conflict as well.

¹²⁰Duelfer, p. 32.

¹²¹According to the testimony of former senior Iraqi officers: “The few commanders who realized how desperate the situation had become were afraid to relay honest battlefield assessments up the chain of command.” As one former general put it: “It was well known that President Hussein did not care to receive bad news.” See Zucchini, “Iraq's Swift Defeat,” p. 1.

¹²²Duelfer, p. 67.

¹²³Transcript of interview with Lieutenant General David D. McKiernan, Commander, 3rd Army, and CFLCC, for an episode of the PBS program *Frontline* entitled “The Invasion of Iraq,” first aired February 26, 2004. As of August 2007:

<http://www.pbs.org/wgbh/pages/frontline/shows/invasion/interviews/mckiernan.html>

The Iraqi Republican Guard II Corps commander believed that the main axis of the U.S. attack toward Baghdad was along the approach west of the Euphrates River and further realized that Karbala was the “neck of the bottle” and that once U.S. forces had passed that point, they intended “to advance to Baghdad, moving towards Usfiyah, the airport, and then the presidential palaces.”¹²⁴ The II Corps commander’s view that the Karbala Gap constituted the key potential bottleneck to the U.S. advance was fully shared by U.S. planners and commanders.¹²⁵

Yet Baghdad not only refused to sanction the reinforcement of Karbala but also ordered that Iraqi forces be pulled back from that area because they were thought to be too vulnerable in the terrain west of the Euphrates River.¹²⁶ As a consequence, U.S. forces found “the Karbala Gap lightly defended.”¹²⁷

Perhaps the most wrongheaded positioning of Iraqi forces occurred on April 2, when Saddam ordered his commanders to move the Republican Guard Al Nida Armored Division that was defending the southern approaches to Baghdad to a position northwest of the capital to meet a U.S. attack from that direction. The regular army’s 16th Infantry Division was also to be moved to reinforce the Al Nida Division in its new locale.¹²⁸ Saddam’s order was conveyed by the Iraqi defense minister, General Al Ta’i, at a meeting in Baghdad attended by Qusay, the regular army chief of staff, the Al Quds Army chief of staff, the Republican Guard chief of staff, and the commanders of the Republican Guard I and II Corps.

General Al Ta’i disclosed that Saddam had concluded that the U.S. units closing in on the capital city from the south were simply part of “a strategic deception” and that the real attack on Baghdad would “be from the north,” conducted by U.S. forces “coming from the western front” (i.e., Jordan).¹²⁹

Saddam’s remarkable finding reflected the extreme poverty of his situational awareness. It came when the U.S. 3rd Infantry Division forces had already moved

¹²⁴*Frontline* interview with Lieutenant General Al-Hamdani.

¹²⁵“Virtually every American army officer knew about the gap from wargames and exercises at places as far afield as Fort Hood, Texas, and Grafenwoehr, Germany, because the city of Karbala represented the gateway to Baghdad.” See Murray and Scales, pp. 203–204.

¹²⁶See transcript of the PBS program *Frontline*, “The Invasion of Iraq,” first aired February 26, 2004. As of August 2007:

<http://www.pbs.org/wgbh/pages/frontline/shows/invasion/etc/script.html>

One senior Iraqi officer said Qusay had ordered the Republican Guard regiments to withdraw from the desert west of the capital to Baghdad. He went on to say that these soldiers, who were vital to the city’s defense, then took off their uniforms and went home. See Fisk.

¹²⁷Fontenot, Degen, and Tohn, p. 283.

¹²⁸The defense of the northern approaches to Baghdad were the immediate responsibility of the Republican Guard I Corps commander.

¹²⁹*Frontline* interview with Lieutenant General Al-Hamdani.

through the Karbala Gap and crossed the Euphrates River at Objective PEACH and U.S. Marine Corps troops were approaching Baghdad along the Tigris River valley.¹³⁰

The Republican Guard II Corps commander, General Al-Hamdani, objected to both the assessment of the threat and the accompanying order. He stated that his troops were in contact with the advancing American forces on several fronts (including near Karbala) and that the U.S. lines of march were indeed coming from the south.¹³¹

The defense minister told General Al-Hamdani that no discussion was permitted, because this was a “message from the president” and that all commanders should start moving their troops to meet an attack from the north, beginning at 5:00 A.M. the next day, April 3.

Demonstrating how loath even the most senior Iraqi officers and officials were to contradict Saddam Hussein, General Al-Hamdani reports that when the other attendees at the meeting were asked for their views, “no one supported [his] opinion.”¹³² One Republican Guard unit (most probably attached to the Al Nida Armor Division), ordered to give up “good defensive positions south of Baghdad on April 3” and move north, apparently abandoned its armor and other heavy weapons in the process. Amer Na’ama Abed, a Republican Guard major in the unit, recalled: “We couldn’t believe it. Our artillery was ready, the tanks, everything was ready for battle.” But following the order to move, “Guns and tanks were left in the open. We only carried with us rifles, launchers and guns, which we managed to take in a hurry.” Major Abed and his fellow officers found the move so inexplicable that they suspected they had been betrayed by commanders who had been paid off by the Americans.¹³³

Coalition warfighters were impressed by how poorly trained their Iraqi opponents appeared. This lack of training was reflected in the Iraqis’ inability to carry out basic military operations. Among other shortcomings, the Iraqi forces appeared unable to

¹³⁰See Chapter Four for a detailed account of the battle at Objective PEACH.

¹³¹Al-Hamdani told the officers that his description of the likely course of the U.S. advance on Baghdad “was not a personal speculation,” but was “the exact words of Israeli Prime Minister Ariel Sharon to President Bush,” which he “had read on the Internet about six weeks ago.” After hearing Al-Hamdani, Qusay asked him, almost in a whisper, “Are you sure of what you are saying?” Al-Hamdani answered, “Yes, as I’m sure that I’m talking with you now.” *Frontline* interview with Lieutenant General Al-Hamdani.

¹³²When asked by his interviewer why his colleagues had reacted as they had, General Al-Hamdani avoided criticism, stating that “all there in the audience were competent, experienced, and patriotic officers, but maybe for the reasons of military discipline, or there has been some confusion in their strategic views, so there were no measures taken to rectify this vision.” Al-Hamdani believed that Qusay was convinced by his presentation: “I saw it in his face. When he told me to move the troops from my army to the army defending north of Baghdad, he was saying it [was] not a order from him, but . . . an order he [was] obliged to obey.” *Frontline* interview with Lieutenant General Al-Hamdani.

¹³³According to Major Abed, commanders under Saddam “were paid extraordinary sums of money to gain their trust and allegiance to the regime. They were given money, palaces, and land. In my opinion, the Americans used the same method. I believe that money was the reason why most commanders succumbed.” See “Treachery: How Iraq Went to War Against Saddam,” *London Sunday Times*, January 11, 2004.

(1) coordinate supporting arms and maneuver, (2) exploit cover and concealment, and (3) shoot accurately.

The inability of the Iraqi Republican Guard and regular army forces to carry out basic military operations testified to their lack of training. Lieutenant General James Conway, commander of the 1st Marine Expeditionary Force in OIF, characterized the resistance put up by the Republican Guard and regular army as “not terribly effective.” As General Conway saw it:

Any army should have the ability to coordinate its supporting arms, its defensive positions, its long range fires with its close range fires, [et cetera]. And that simply didn't happen. I can't cite you a single incidence where we would qualify [the resistance] as being very effective.¹³⁴

To protect their heavy Republican Guard units, the Iraqis widely dispersed their tanks and APCs in revetments and also attempted to hide them in palm groves. They moved their equipment around so that equipment found during the day “might not be there that night.”¹³⁵ However, Stephen Biddle found that Iraqi attempts to protect their forces from air and ground attack generally fell short of what was needed. The Iraqis were able to provide some concealment against air attacks for some units. “But they were much less successful in creating adequate cover. And they were systematically unable to combine cover, concealment, and an adequate field of fire for their own weapons.” The horseshoe revetments they dug for many of their armored vehicles provided little, if any, protection from stand-off M1A1 tank fire. The Iraqis also made little use of concealment and cover in built-up areas.¹³⁶

The tactics used by the Fedayeen Saddam and Ba'ath Party militias and foreign jihadists reflected almost a complete absence of conventional military training. The paramilitaries were lightly armed, their principal weaponry being AK-47s, grenades, rocket-propelled grenades, and mortars. Nearly always on the tactical offensive, these paramilitary units made little if any use of concealment or cover but typically elected to attack U.S. armored elements in the open, taking huge losses in the process. Their near-suicidal behavior in battle may have partly been a function of their ignorance about the consequences of frontally attacking armored vehicles in open terrain. As Stephen Biddle described it, “Iraqi tactics could charitably be described as self-defeating.”¹³⁷

¹³⁴Transcript of interview with Lieutenant General James Conway, Commander, 1st Marine Expeditionary Force, for an episode of the PBS program *Frontline* entitled “The Invasion of Iraq,” first aired February 26, 2004. As of August 2007:

<http://www.pbs.org/wgbh/pages/frontline/shows/invasion/interviews/conway.html>

¹³⁵*Frontline* interview with Lieutenant General Wallace.

¹³⁶U.S. House of Representatives, *Statement of Dr. Stephen Biddle*.

¹³⁷U.S. House of Representatives, *Statement of Dr. Stephen Biddle*. Also see Stephen Biddle et al., “Iraq and the Future of Warfare,” briefing, Strategic Studies Institute, U.S. Army War College, August 18, 2003.

Coalition forces were also fortunate in that Iraqi marksmanship was so poor. This inaccuracy was apparent in both Iraqi regular military and militia units, and was frequently commented on by U.S. forces. Among U.S. Marine Corps units, “everyone on the front lines” gradually developed “skepticism about, if not disdain for, Iraqi marksmanship.”¹³⁸ Marines described the typical Iraqi firing routine as “spray and pray.” The poor marksmanship was attributed to “radically substandard training” in weapons employment.¹³⁹

The Iraqi forces were further disadvantaged in that much of their military equipment was inferior to that of the coalition. The armor, artillery, and other equipment losses Iraq had suffered in the 1991 Gulf War and subsequently was enormous, as depicted in Table 6.1. During the course of that conflict, the Iraqi military lost approximately half of its prewar inventory of tanks and artillery tubes and over a third of its inventory of APCs. In addition, the Iraqi ground forces are estimated to have lost many thousands of their trucks and possibly as much as half of their heavy equipment transports (HETs).¹⁴⁰ The UN sanctions imposed after the Gulf War prevented Iraq from replacing these lost items as well as its remaining, largely obsolete, Soviet-designed armory with modern weapon systems or from getting spare parts to keep the aging equipment operating. According to one assessment, as much as 50 percent of Iraq’s estimated inventory of main battle tanks, BMPs and armored personnel carriers, towed artillery pieces, multiple rocket launchers, and helicopters lacked needed spares. Among other crucial missing items were new night-vision devices to replace the worn-out devices on Iraqi tanks.

Table 6.1
The Drop in Iraqi Military Capability, 1990–2002

Equipment	1990 Inventory	2002 Inventory	Percent of 1990 Total
Tanks	5,600	2,600	47
Artillery	3,700	2,300	60
APCs	7,500	3,000	40
Ground forces	995,000 ^a	350,000 ^b	35
Fighter aircraft	360	180	50
Bombers	16	6	40

SOURCE: International Institute for Strategic Studies, *The Military Balance 1990–1991 and 2002–2003*, London, UK, 1990 and 2002.

^a Includes 480,000 reservists.

^b Includes 100,000 reservists.

¹³⁸Bing West and Major General (USMC ret.) Ray L. Smith, *The March Up*, New York: Bantam Books, 2003, p. 144.

¹³⁹U.S. House of Representatives, *Statement of Dr. Stephen Biddle*.

¹⁴⁰Hosmer, p. 181.

By the time the Iraqi military entered its second war with the United States, it was a “suffering, weakened institution.” As General Qahtan al-Tamimi, a 37-year Iraqi military veteran, put it: “Our army was systematically destroyed over time as no other army in history.”¹⁴¹

Coalition air operations in the no-fly zones during the years prior to OIF also significantly diminished Iraqi combat capabilities. Beginning in June 2002, coalition air strikes on Iraq’s integrated air defense system in the no-fly zones, including its surface-to-air missiles and their command and control, were stepped up, further degrading an already impaired air defense network.¹⁴²

Poor Motivation and Morale Decisively Undermined the Iraqi Defense

While poor planning, leadership, training, and equipment contributed to the rapid Iraqi defeat, the prime reason for the lack of resistance was the Iraqi military’s extremely poor motivation and morale. The vast bulk of the officers and troops in the regular army, Republican Guard, and Special Republican Guard did little if any fighting and deserted their units before being engaged by coalition ground forces. The reasons for this lack of fighting will and high desertion rate were several: (1) the poor morale that existed prior to the outbreak of hostilities, (2) the widespread conviction that resistance was futile, (3) the absence of a belief in the cause, (4) the erosion of previous barriers to desertion, and (5) the effect of U.S. air attacks.

PSYOP and the rapid advance, technological supremacy, and firepower of U.S. ground forces also helped undermine the enemy’s will to resist. The limited resistance that was encountered by coalition forces came mainly from Iraqi militia units, the Saddam Fedayeen, the Ba’athist militia, and foreign jihadists, though small elements from various Iraqi Republican Guard and regular army units did fight. The entry of U.S. units into Baghdad and the fall of the capital on April 10 brought an end to organized resistance.

Senior Iraqi officers as well as rank-and-file troops interviewed after the collapse of Saddam’s regime report that the motivation and morale of Iraqi military forces was poor long before the first U.S. troops crossed the Iraqi border on March 20.¹⁴³ In the months leading up to the war, there were numerous reports of low morale and high desertion rates within Iraqi units. Iraqi military officers who fled to Europe in mid-2002, for example, claimed that more than a quarter of the 375,000-man Iraqi army

¹⁴¹ May Ying Welsh, “U.S. Trains Proxy to Quell Resistance,” Aljazeera.net, June 6, 2004.

¹⁴² Susan Chapman, “The ‘War’ Before the War,” *Air Force Magazine*, February 2004, p. 52.

¹⁴³ William Branigin, “A Brief, Bitter War for Iraq’s Military Officers,” *Washington Post*, April 27, 2003, p. A25.

were “missing from their posts as a result of poor and irregular pay, fear of bombing, and concern about potential purges.”¹⁴⁴

According to Colonel Abu Ala Zuhairi, who served 23 years in infantry air defense units, “the army was fed up and tired of fighting after three wars, . . . The commanders received many presents, but the soldiers were starving.”¹⁴⁵ Aside from poor pay and food, conscripts (who were mainly Shi’ites) were often badly mistreated by their Sunni officers.¹⁴⁶ They were apparently also mistrusted by their superiors, as some troops were given only a single magazine of ammunition.¹⁴⁷

To escape the poor food and other vicissitudes of military life, Iraqi soldiers constantly sought home leave to visit their families, requests that were often granted only after suitable bribes had been paid to their officers.¹⁴⁸ Whether because of desertions or recruitment problems, regular army units were significantly undermanned, some possessing as little as 40 percent or less of their authorized strength.¹⁴⁹

A telling manifestation of the endemic poor morale in Iraqi units was the propensity of Iraqi troops to carry civilian clothing along with their military gear. The troops were preparing for their eventual desertion even before the outbreak of hostilities. American officers reported finding piles of discarded uniforms when they overran abandoned Iraqi military positions.

Prewar morale within the senior ranks of the Iraqi officer corps was also poor. When Saddam told his senior officers in December 2002 that they might have to fight the United States without WMD, “military morale dropped rapidly.”¹⁵⁰ Those Iraqi officers who had detailed information about U.S. capabilities had realized “that the imbalance in power between Iraq and the United States was so disparate that they were incapable of halting a U.S. invasion.”¹⁵¹

Morale was also undermined by the “culture of lying” that permeated the military’s ranks and by the disdain many officers held for the inept loyalists Saddam had placed in key command positions. The bureaucracy and widespread corruption that plagued the armed forces also diminished morale. According to General Al-Hamdani,

¹⁴⁴ See Ewen MacAskill and Julian Borger, “Iraq ‘to Allow Arms Inspectors,’” *Guardian Weekly* (London), May 2–8, 2002, p. 2.

¹⁴⁵ Moore, “A Foe That Collapsed from Within,” p. A1.

¹⁴⁶ Slocombe, p. A29.

¹⁴⁷ Zucchini, “Iraq’s Swift Defeat,” p. 1.

¹⁴⁸ In some units, home leave was granted to personnel ten days out of every month. See Leonard Wong, Thomas A. Kolditz, Raymond A. Millen, and Terrence M. Potter, *Why They Fight: Combat Motivation in the Iraq War*, Carlisle, PA: Strategic Studies Institute, U.S. Army War College, July 2003, p. 8.

¹⁴⁹ Wong et al., p. 8.

¹⁵⁰ Duelfer, p. 65.

¹⁵¹ Duelfer, p. 32.

Commitment to Iraqi military honor was weakened, due to economic sanctions. Administrative corruption was widely spread. One day the supervisor [Qusay] asked me about the behavior of our armed forces. I replied that there was [a] high level of bureaucracy; it was like a tumor.¹⁵²

Some officers also made preparations to desert. Iraqi soldiers reported instances in which their officers ordered military vehicles spray-painted in nonmilitary colors, “intending to drive them home for personal use after deserting.”¹⁵³

One fundamental reason the Iraqis chose not to fight in OIF was because both officers and enlisted personnel were convinced that any attempt at resistance would be futile. They believed their diminished military forces would be no match for the technologically superior U.S. air and ground forces in conventional combat. Senior Iraqi commanders had observed the devastating effects of U.S. air supremacy during DESERT STORM and during the subsequent 12-year enforcement of the no-fly zones, and realized they would be unable to protect their forces against U.S. air attacks.

Thus, with the exception of Saddam Hussein and some of his immediate family members and political cohorts, pessimism about the possibility of successfully fending off a U.S. attack appears to have permeated all levels of the Iraqi military command structure. Even Saddam’s former minister of defense, General Al Ta’i, thought the war would be lost rapidly:

We knew the goal was to make the Regime fall. . . . We thought the forces would arrive in Baghdad or outside Baghdad in 20 days or a month. We accepted that the cities on the way would be lost. All commanders knew this and accepted it.¹⁵⁴

Many members of the Republican Guard forces also thought resistance would be futile. Colonel A. T. Said, who commanded an engineering unit attached to the Republican Guard Hammurabi Division, testified that the Republican Guard troops he knew believed that war would be “madness.” “We knew we would never fight. I thought the war would never start because it was madness.”

Colonel Said went on to describe the cynicism of the sycophantic Republican Guard generals who assured Saddam of military victory during televised meetings. “They told him we would fight any power in the world. When we heard this, we couldn’t believe it. But then the generals told us, ‘No, no—don’t worry. Just keep quiet. Stay in your positions. It won’t happen.’”¹⁵⁵

¹⁵² *Frontline* interview with Lieutenant General Al-Hamdani.

¹⁵³ Zucchini, “Iraq’s Swift Defeat,” p. 1.

¹⁵⁴ Quoted in Duelfer, p. 67.

¹⁵⁵ David Blair, “145 of My 150 Men Fled, Says Guard Officer,” *Daily Telegraph*, April 14, 2003.

According to General Saadoun Mahmmoud Saadoun, officers lied about their motivation and unit capabilities. Every one of them realized that their tanks, aircraft, and other weaponry were too old and decrepit to effectively confront U.S. forces. “We knew there was no way to fight the Americans,” Saadoun said. “We knew we’d lose the war.”¹⁵⁶

In the view of one Iraqi colonel, the Iraqi armed forces were doomed to defeat from the outset because they had never recovered from the beating they had taken in the 1991 Gulf War. According to the colonel:

You can’t fight with what was left . . . and this war was not just about what you learn at the military academy—it is technological and we recognized that . . . The Army believed that from the first bullet fired by the British in the south, it would lose.¹⁵⁷

But some Iraqi officers thought Iraq’s defeat would take longer than it did. Major Saleh Abdullah Mahdi Al Jaburi, who was a battalion commander in the Army’s 2nd Infantry Division, knew defeat was inevitable but was surprised at its swiftness:

But we were expecting that the war would last longer than it did. We were desperate when Baghdad fell so quickly. If we were not Muslims we would have done like the Japanese and committed suicide [but] . . . our religion forbids it.¹⁵⁸

Brigadier General Hassen Jabani, who commanded a tank division in the Republican Guard, reported that the day before U.S. air strikes on April 4 had turned his T-72 tanks into burning hulks, his soldiers had begun to desert in droves believing that any attempt at defense was futile:

Seventy percent of my soldiers went home. I saw we had no chance to win. I let them go. We retreated without any fighting. It was no use . . . Everybody knew we’d lose to the Americans.¹⁵⁹

Sometimes Iraqi commanders held meetings with their men even in the midst of battle to decide whether to fight or flee. Colonel Abdul Kareem Abdul Razzaq, whose unit was involved in the fighting at the Baghdad International Airport, recounted telling his men:

¹⁵⁶ See quotes from interview with General Saadoun in Moore, “A Foe That Collapsed from Within,” p. A1.

¹⁵⁷ Peterson and Ford, pp. 1 and 12.

¹⁵⁸ Peterson and Ford, pp. 1 and 12.

¹⁵⁹ Moore, “A Foe That Collapsed from Within,” p. A1.

The [U.S.] Air Force is bombing, there's a huge American Army coming we can't fight, [and] we are losing control . . . We've been ordered to continue fighting. What do you think we should do?

Colonel Abdul Razzaq reported that his men—the remaining 600 of his original 1,500 soldiers who had not deserted or been killed in the battle for the airport—were nearly unanimous in their decision to go home. “I gave the order to retreat . . . If I had given the order for my soldiers to stay, they'd all be killed.”¹⁶⁰

If defeat was inevitable, most of the officers and enlisted men of the regular army and the Republican Guard forces saw little or no reason to fight and die for Saddam and his regime. Even though they depended on Saddam for their positions and were the recipients of his cash bonuses and other largesse, many senior Iraqi officers apparently felt little loyalty toward the Iraqi leader, his sons, or the militarily incompetent relatives he had placed in many high commands.

Iraqi officers also apparently did not believe that a coalition victory over Saddam would necessarily be catastrophic for their own careers and livelihood. Some Iraqi officers did not expect that coalition forces would seize Baghdad or that Iraq would be “occupied.” The commander of the Republican Guard Nebuchadnezzar Division, for example, stated: “We thought the coalition would go to Basrah, maybe to Amarra, and then the war would end.”¹⁶¹

Others, while anticipating an occupation, probably did not expect the dissolution of the Iraqi military and the banning of most former general officers from positions in the new Iraqi military. Indeed, some officers assumed they would keep their “privileged position in the military even if it meant serving a new master.” Lieutenant Colonel Amer Abdullah al-Rubaie, a special forces instructor and son of a retired general, lamented the fact that he had not been called back to duty at the end of the war as he had anticipated: “All of us thought that we'd take our places again and help stabilize the situation.”¹⁶²

Many other officers no doubt understood that the demise of Saddam's regime would probably mark the end of their military careers. However, there is little if any evidence that concerns about postwar status motivated any appreciable numbers of regular army and Republican Guard officers to resist. For those regular military officers who chose to stand and fight during OIF, the principal motivation appears to have been their desire to uphold their nation's honor and their own military honor by carrying out the duties assigned them.

¹⁶⁰Moore, “A Foe That Collapsed from Within,” p. A1.

¹⁶¹Duelfer, p. 67.

¹⁶²Susan Sachs, “A Former Iraqi Officer Denied His Old Post, Fumes at the U.S.,” *New York Times*, November 2, 2003, p. A12.

General Ghanem Abdullah Azawi, an engineer in the Iraqi regular army air defense command, attributed the Iraqi refusal to fight to the fact that “The army didn’t believe in it, because it wasn’t a war, it was suicide.” As the senior Iraqi commanders viewed it, “this war has no result, only death. Why should we fight to save Saddam? That’s why most of the commanders told their soldiers not to fight, just withdraw.”¹⁶³

If officers had little positive motivation to fight for Saddam and his regime, Iraqi enlisted personnel apparently had even less. Interviews with some 30 Iraqi enemy prisoners of war (EPWs), largely from regular army units, uncovered no evidence that Iraqi enlisted personnel were motivated by considerations of Iraqi nationalism or the need to repel an American invasion force. Instead, the interviews showed that these Iraqi soldiers were motivated in the main by coercion, “the fear of retribution and punishment by Ba’ath Party or Fedayeen Saddam if they were found avoiding combat.”¹⁶⁴ When Iraqi troops deserted, they invariably took their weapons to protect themselves from members of the Fedayeen Saddam death squads they might encounter in the rear areas.¹⁶⁵

Military discipline within the Iraqi military was largely maintained by fear. Officers closely controlled their troops, and even slight infractions tended to be severely punished. As a senior officer captured during the 1991 Gulf War put it:

Iraqi military discipline, especially with enlisted soldiers, is based on fear. Soldiers are not motivated by the leadership, they are distrusted and are not taught to have initiative . . . Even in completing the simplest task, Iraqi soldiers are closely supervised and are treated as if they were mentally deficient.¹⁶⁶

The behavior of Iraqi officers was also monitored, both by their superiors and by the members of the Special Security Organization and the Directorate of General Military Intelligence who were embedded in the Republican Guard and regular army divisions.

In OIF, the barriers to desertion disappeared entirely. There were two reasons for this: (1) the threat of eventual punishment dissolved and (2) discipline was no longer enforced.

During OIF, the threat of eventual punishment that had once deterred would-be deserters from fleeing their units was no longer credible. In previous wars, deserters had run the risk of being hunted down by Saddam’s security services and severely pun-

¹⁶³Branigin, 2003, p. A25.

¹⁶⁴Except for a lieutenant colonel and a lieutenant, all the EPWs were lower-ranking enlisted Iraqi soldiers. Two sergeants claimed to have served in Republican Guard or Special Republican Guard units. See Wong et al., pp. 5, 7, and 9.

¹⁶⁵Wong et al., p. 7.

¹⁶⁶Hosmer, p. 121.

ished. During the Iran-Iraq War deserters were frequently executed, sometimes along with the members of their families. Although battlefield executions were relatively rare during the 1991 Persian Gulf War, would-be deserters still had to worry about both the possibility of capture by the death squads Saddam had positioned behind Iraqi lines and the risks of eventual arrest and punishment even after the war was over.¹⁶⁷

In the days prior to OIF, the prospect of punishment remained a barrier to desertion for some Iraqi troops, as such action could sometimes result in the cutting off of an ear.¹⁶⁸ However, once OIF was under way, the prospect that Saddam's regime would be ousted eliminated the threat of eventual punishment. Iraqi troops apparently delayed their desertion until they had evidence that coalition forces had indeed invaded the country and seemed intent on ousting the regime. Some Iraqis saw the targets of U.S. air strikes as indicators of coalition intent. When Ba'ath Party and other regime headquarters were struck, Iraqis became more convinced that Saddam would be ousted. This, among other reasons, explains why desertions greatly increased as the demise of Saddam's regime appeared to come closer.

Probably an even more important reason for the massive Iraqi desertions was that the officers who were supposed to enforce discipline deserted themselves or, as was the case most frequently, they sanctioned, facilitated, and even ordered the desertion of their troops. Because they believed that Saddam's regime did not merit defending and that resistance would be futile, many Iraqi generals and other senior officers—whose duty it was to lead their troops into battle and prevent desertions in their units—decided to forsake these basic military responsibilities. Some 30 or so Iraqi prisoners of war, interviewed in April 2003, indicated that their “officers permitted surrender, sometimes by their own desertion, sometimes by benign neglect.”¹⁶⁹

Massive desertions occurred within even the most elite Republican Guard units, as senior commanders proved unwilling to push their troops toward inevitable slaughter by technologically superior U.S. forces. The commander of a Republican Guard armored brigade reportedly was told on April 4 to abandon his tanks south of Baghdad and “have his men change into civilian clothes.” Minibuses took the troops to their home base near the northern city of Mosul, “where the soldiers simply quit and went home.”¹⁷⁰

Coalition troops have consistently noted that some of the most aggressive opposition they encountered was from irregular militia forces. The Fedayeen Saddam militia, the Ba'ath Party militia, and the foreign jihadist fighters proved to be the exceptions in an Iraqi force structure that showed little will to fight. These militias and jihadists were motivated to fight because they had a major stake in the survival of Saddam's regime

¹⁶⁷ Hosmer.

¹⁶⁸ Sachs, 2003, p. A12.

¹⁶⁹ Wong et al., p. 8.

¹⁷⁰ Zucchino, “Iraq's Swift Defeat,” p. 1. Also see Moore, “A Foe That Collapsed from Within,” p. A1.

or because they believed in the cause of defending Iraq against U.S. and other invaders. However, despite their zeal to close with coalition forces, the battlefield effectiveness of these irregulars was limited because they were lightly armed and poorly trained and led. As a consequence, they died in large numbers.

The Fedayeen Saddam (Saddam's "Men of Sacrifice") were largely uneducated youths drawn from Saddam's al-Bu-Nasir tribe or from other clans immediately north of Baghdad where Saddam's support was strongest. They were fanatically loyal to Saddam, having been conditioned by his cult of personality and instilled with the belief that their fate was directly tied to the fate of his regime and person.¹⁷¹ The Fedayeen militia was commanded by Saddam's son Uday, who had organized the force in 1991. It probably numbered somewhere between 20,000 to 40,000 fighters.¹⁷²

Members of the Fedayeen Saddam militia were widely hated by ordinary Iraqis, and they may have feared that if Saddam's regime fell they could be the subjects of severe reprisals.¹⁷³ Many Iraqi regular army and Republican Guard leaders found the Fedayeen Saddam's arrogant and freewheeling behavior to be repugnant and considered the militia members to be no more than "lower class" mercenaries. The Fedayeen were also resented because they were the recipients of special privileges: their pay was 40 percent higher than that of the regular military, and their cars and housing were often subsidized.¹⁷⁴

Elements of the Ba'ath Party militia also fought. These Ba'ath Party fighters—who probably numbered in the thousands—were apparently drawn in part from the 40,000 or so "full" members of the party who were particularly loyal to Saddam Hussein. As members of Iraq's ruling elite, they also had an important stake in the survival of the regime.¹⁷⁵

In the run-up to the war, large numbers of Ba'ath Party members were armed and organized for combat. Aside from taking an active part in the urban fighting, the Ba'ath Party militia were also charged with preventing civilian uprisings and otherwise

¹⁷¹ See Kanan Makiya, "The Fedayeen Saddam Keep Shia Intifada in Check," *New Perspectives Quarterly*, Vol. 21, No. 3, Summer 2004, and David Blair, "Why the Fedayeen Fight for Their Lives," *Daily Telegraph*, March 25, 2003.

¹⁷² Estimates of the number of Fedayeen Saddam vary. Secretary of Defense Donald Rumsfeld estimated the militia's probable size at "somewhere between 5,000 and 20,000," whereas Iraqi opposition sources claimed they numbered closer to 50,000. A Council on Foreign Relations estimate put the number at between 30,000 and 40,000, the latter number coinciding with the Jane's estimate of 40,000. See Makiya; Blair, "Why the Fedayeen Fight for Their Lives"; Council on Foreign Relations, "Iraq: What Is the Fedayeen Saddam?" March 31, 2003; and *Jane's Security and Foreign Forces, Iraq*, January 29, 2002.

¹⁷³ See Makiya; and Blair, "Why the Fedayeen Fight for Their Lives."

¹⁷⁴ See Blair, "Why the Fedayeen Fight for Their Lives."

¹⁷⁵ Some two million Iraqis may have been affiliated with the Ba'ath Party in one of five different membership categories: supporter, sympathizer, nominee, trainee, and full. Candidates had to pass through the other four steps before becoming a full member. See "Ba'ath Party Entrenched in Saddam's Cult of Personality."

controlling the Iraqi public in their areas. Party loyalists were deployed in every neighborhood and, in some cities, on every block to keep civilian populations in line.¹⁷⁶

The foreign jihadists were highly motivated combatants in that they had voluntarily come to Iraq for the express purpose of fighting the Americans. As many as 5,000 to 7,000 foreign jihadists entered Iraq prior to the outbreak of hostilities and during the March and early April fighting. Most came from Syria, Jordan, and Egypt, but there were also volunteers from Saudi Arabia, Lebanon, the Palestinian territories, Algeria, Libya, the United Arab Emirates, and Afghanistan.¹⁷⁷ Upon arrival in Iraq, they were provided light weapons and were given weapons training at a variety of camps, sometimes in the company of Fedayeen Saddam and Al Quds personnel.¹⁷⁸

Not all the paramilitaries, however, fought to the bitter end. There were reports of significant Fedayeen Saddam and Ba'athist militia desertion in An Nasiriyah, Najaf, and other southern Iraqi cities. In Baghdad, after some sharp fights with U.S. Army and Marine Corps forces, the paramilitaries simply faded away. On the day before Baghdad's fall:

From dusk to dawn, Baghdad's defenses virtually disintegrated. Thousands of Ba'ath Party militiamen, who had manned every street corner, bridge and intersection, changed into street clothes and went home. Saddam's Fedayeen, black-clad militiamen, who had vowed to fight to the death, were gone by morning, some of them leaving their weapons behind.¹⁷⁹

The desertions typically followed the disappearance of the officers commanding the paramilitary forces. Some Ba'ath Party militia commanders were said to have abandoned their troops on the pretext that "they were leaving for dinner." One senior Ba'ath Party official claimed that he was told by his supervisor to abandon his post on April 7 and return home because the militia's "rifles and rocket-propelled grenades were no match for the might of American forces."¹⁸⁰

¹⁷⁶ "Ba'ath Party Entrenched in Saddam's Cult of Personality."

¹⁷⁷ While Arab governments found it politically difficult to prevent their citizens from joining the jihad in Iraq, some tried to hamper the process. Egypt, for example, after the start of OIF "found itself faced with thousands of Egyptians demanding an opportunity to join their Arab brothers to drive off the Coalition 'unbelievers.'" The government assured the would-be jihadists that nothing would stand in their way, in that "Combating injustice is a religious duty." But in reality, the government "buried their attempts to fight in the red tape of Egypt's formidable bureaucracy." See Andrew McGregor, "Al-Azhar, Egyptian Islam and the War in Iraq," *Terrorism Monitor*, Vol. 2, Issue 12, The Jamestown Foundation, June 17, 2004.

¹⁷⁸ See Steven Stalinsky, "Arab and Muslim Jihad Fighters in Iraq," MEMRI, Special Report No. 19, July 27, 2003.

¹⁷⁹ Anthony Shadid, "For Iraq's Leaders and Loyalists, a Vanishing Act," *Washington Post*, April 12, 2003, p. A21.

¹⁸⁰ Shadid, p. A21.

Aside from the very considerable physical damage they inflicted, U.S. and other coalition air attacks had major psychological effects on Iraqi military forces. “U.S. airpower combined with the lack of any Iraqi air defense capability, proved devastating not only to military equipment, but to the will to fight of soldiers and officers alike.”¹⁸¹ They reinforced the existing Iraqi calculations about the futility of resistance and further lowered the already faltering Iraqi troop morale.

The previously cited interviews with enlisted Iraqi EPWs showed that coalition artillery shelling or air attacks “sometimes catalyzed surrender—though none of the soldiers interviewed had to withstand lengthy bombardment.”¹⁸² Concerns about air attacks motivated Iraqi troops to stay away from their armored vehicles and artillery and, indeed, prompted massive numbers of Iraqis to abandon their equipment on the battlefield and desert home.¹⁸³

A member of the regular army’s general staff, Colonel Ghassan, attributed the Iraqi defeat primarily to the inability of Iraqi commanders to safely move their equipment and troops because of the devastating U.S. airpower and to the disruption of communications between the commanders. Colonel Ghassan reported that the three Republican Guard divisions that Qusay Hussein had ordered repositioned to oppose the coalition advance were essentially destroyed by U.S. air attacks when they were still about 30 miles from their designated new deployment areas south of Baghdad. “This affected the morale of the troops,” Colonel Ghassan said. “The Iraqi will to fight was broken outside Baghdad.”¹⁸⁴

Iraqi troops were disheartened by the ability of U.S. aircraft to find and destroy targets that the Iraqis believed were effectively camouflaged. A Republican Guard captain, Omar Khalidi, recounted his dismay when U.S. aircraft destroyed his surface-to-surface missile unit a few nights before U.S. troops seized Baghdad. “We were surprised when they [U.S. pilots] discovered this place,” said Captain Khalidi. The attack occurred late at night, during a strong sandstorm, and the vehicles were hidden under trees that the troops thought would mask them from observation. Two large bombs and a load of cluster munitions hit the targets, killing six members of Captain Khalidi’s unit and destroying most of their equipment.¹⁸⁵

Coalition bombing engendered fears in the Iraqi forces about their personal survival and the safety of their families. Colonel A. T. Said, who commanded a 150-man Republican Guard unit that was deployed on March 19 to guard a bridge north of Baghdad, described the process of desertion that eventually dissolved his unit. On

¹⁸¹ Branigin, 2003, p. A25.

¹⁸² Wong et al., pp. 7–8.

¹⁸³ See Fisk.

¹⁸⁴ Branigin, p. A25.

¹⁸⁵ Branigin, p. A25.

the day of their deployment, and without a shot having been fired, the security officer responsible for ensuring the unit's loyalty to Saddam deserted—opening the way for others to quit. Thereafter, groups of five or six deserted every day. Once heavy coalition air strikes began, the desertion rate accelerated.

A regular army division suffered air attacks and huge desertions when it attempted to move from its deployment area near Mosul to Baghdad to meet the coalition offensive. The division commander, General Jalal Muhammad, reports that of the 7,800 troops he had when the division started its redeployment, only 50 remained by the time it reached the capital. General Muhammad attributes his division's evaporation to coalition air attacks, which his troops were helpless to counter:

We were bombed before we even left our base—while we were packing. The rest fled or died along the way. My soldiers were not cowards, but it was like we were holding a stick in our hands and the enemy had an AK-47.¹⁸⁶

The coalition mounted a major PSYOP campaign in Iraq both prior to and during OIF. Some 19 million leaflets were dropped on Iraqi territory between October 2002 and March 20, 2003, when the ground combat began. An additional 31 million leaflets were dropped during the fighting that followed. Thousands of hours of radio broadcasts were also directed at Iraqi audiences from both land stations and Hercules C-130 Commando Solo aircraft. To cue the potential radio listeners, leaflets were dropped instructing the Iraqis about the frequencies over which the coalition's "Information Radio" could be heard.¹⁸⁷

Leaflets intended for Iraqi military forces attempted to influence Iraqi battlefield behavior in at least four ways: (1) to surrender, (2) to abandon their weapons, (3) to return to their families, and (4) to avoid certain actions, such as not to target coalition aircraft or employ WMD.¹⁸⁸

It is difficult to assess the effects of this PSYOP campaign on the behavior of Iraqi forces. The surrender appeals, which were a major focus of the campaign, apparently had little direct effect on Iraqi troops' behavior because comparatively few Iraqi units or individuals surrendered. However, massive numbers of Iraqis did abandon their armored vehicles and crew-served weapons and returned to their homes, which suggests that these particular appeals may have had some effect. As is the case with most

¹⁸⁶Welsh.

¹⁸⁷A description of the various leaflets dropped in OIF is provided by Herbert A. Friedman, "Operation Iraqi Freedom." See also Chapter Seven.

¹⁸⁸Examples of coalition messages: (1) calling on troops to surrender were leaflets IZD-0330, IZD-033p, IZD-069, and IZD-8104; (2) calling on troops to abandon their weapons were leaflets IZD-017e and IZD-017d; (3) calling on troops to return to their families were leaflets IZD-029, IZD-050, and IZD-7509; and (4) calling on troops to avoid certain actions were leaflets IZD-041 and IZD-2502. See Friedman. Coalition capitulation and desertion messages are depicted in the next chapter in Figure 7.11.

PSYOP evaluations, it is difficult to differentiate between the effects of PSYOP appeals and the psychological effects of coalition air strikes and ground force attacks. Interviews with Iraqi officers and troops indicate that the latter were the principal motivating factors. It was the dread of impending battle, the experience of actual battle, and the absence of any motivation to fight that caused the vast majority of Iraqi forces to abandon their weapons and return home.

Iraqi views on the effectiveness of the U.S. information operations to persuade senior Iraqi officers and officials to desert or join with the United States were mixed.¹⁸⁹ One former Iraqi colonel believed that the PSYOP messages directed at senior commanders via fax and emails had a “big impact” before those lines of communication were cut ten days before the start of the war.

Interrogations of other Iraqi officers suggest that the positive effects of such contacts were indirect. When calls went out to the private telephone numbers of selected senior officials in Iraq asking them to turn against Saddam Hussein and avoid war, the Arabic speakers “making the calls were so fluent that the recipients did not believe the calls were from Americans.” Instead, the Iraqi officials believed the calls were part of a “loyalty test” mounted by Saddam’s security services.¹⁹⁰

The U.S. Arabic speakers who broadcast PSYOP messages on the Iraqis’ own military communication nets, while detectable as non-Iraqis, nevertheless had a major effect on at least some Iraqi audiences. The brigadier general who commanded Baghdad’s missile air defenses, reports that the voices that cut into his military radio traffic signaled Iraq’s coming defeat.

I would talk to my missile crews and suddenly the Americans would come on the same frequency . . . They would talk in Arabic—with Egyptian and Lebanese accents—and they would say, “We have taken Nasiriyah, we have captured Najaf, we are at Baghdad airport.” It was the psychological war that did the worst damage to us. The Americans knew all our frequencies. By then, we had no radio news broadcast of our own, just the Americans talking directly to us on our radio net. I could have replied directly to those voices, but we were ordered not to, and I obeyed my own security.¹⁹¹

¹⁸⁹For discussions of the operations to forge alliances with Iraqi officers before and during OIF, see Douglas Jehl with Dexter Filkins, “U.S. Moved to Undermine Iraqi Military Before War,” *New York Times*, August 10, 2003, p. A1; Rowan Scarborough, “U.S. Seeks Surrender of Iraqi Leaders,” *Washington Times*, March 17, 2003, p. A10; and Peter Baker, “U.S. to Negotiate Capitulation Agreements with Iraqi Military,” *Washington Post*, March 18, 2003. The very surfacing of such operations in the media had a psychological effect on Saddam and senior Iraqi leaders, as it increased distrust in the Iraqi officer corps.

¹⁹⁰Shanker, “Regime Thought War Unlikely.”

¹⁹¹Fisk.

The arrival of U.S. forces on the outskirts of Baghdad surprised many Iraqi senior officers and had a devastating effect on morale. The subsequent “Thunder Runs” into Baghdad, as well as the sudden escape from the city by Saddam Hussein and other top Iraqi leaders, essentially ended organized resistance within the country.

Desertions soared as U.S. forces neared Baghdad. Major Jaffer Sadiq, a special forces commander, reported that after being ordered on April 2 to rush to Baghdad from the northern city of Kirkuk, he was told that he would be joining some 4,000 Republican Guard troops defending a site in the capital. However, when he arrived in Baghdad he found less than 1,000 Republican Guard troops, and “most of these” deserted by the time the first U.S. Thunder Run had been made through southwest Baghdad on April 5.

Major Sadiq reports that between April 2 and April 5, desertions had depleted his company from 131 men to 10: “I woke up on the morning of April 5 and an entire battalion was gone. They had become vapors.”¹⁹²

The fact that U.S. units had reached Baghdad undermined the fighting will of Iraqi units elsewhere in the country. A regular army unit based in Al Amarah in southern Iraq also began to disintegrate on April 3 when news was heard that American forces had reached Baghdad. Troops began to desert when the unit’s food supply was cut off the next day. As an Iraqi colonel stationed with the unit described the situation: “Soldiers started asking: ‘Why are we using the reserve food?’ and on April 4 they began to run away.”¹⁹³

When word came that American forces had entered the capital, senior Iraqi officers were “stunned.” An Iraqi air force brigadier general described the reaction at his Baghdad headquarters:

When we were working in my operations room and we heard that the Americans had arrived in the city, none of us there believed it. This was impossible, we thought.¹⁹⁴

A Republican Guard colonel encountered a similar reaction after he returned to his headquarters an hour northeast of Baghdad and informed his fellow commanders that U.S. tanks had penetrated Baghdad. The other officers “called him a liar.”¹⁹⁵

Some officers were deluded by the optimistic reports of the Iraqi minister of information, Mohammed Said Sahaf (Baghdad Bob), who brazenly claimed that the

¹⁹² Zucchini, “Iraq’s Swift Defeat,” p. 1.

¹⁹³ Peterson and Ford, p. 12.

¹⁹⁴ See Fisk.

¹⁹⁵ See Zucchini, “Iraq’s Swift Defeat,” p. 1.

Baghdad International Airport had been retaken from coalition troops.¹⁹⁶ Iraqi general officers also believed the story of an Iraqi victory at the airport. A Republican Guard general, Mohammed Daash, was dispatched to check out the rumor that four or five U.S. tanks had survived the Iraqi counterattack. General Daash reportedly returned to his headquarters in a state of panic. “Four or five tanks!” he exclaimed to his fellow generals. “Are you out of your minds? The whole damn American Army is at the airport!”¹⁹⁷

By April 7, according to eyewitnesses, Saddam and Qusay had been reduced to attempting to command the remaining Iraqi forces from a roving convoy of four-wheel-drive Toyotas that was trying to stay one step ahead of the U.S. tanks operating in Baghdad at that moment. A Republican Guard division commander said he met with Saddam and Qusay at the 14th of July bridge in central Baghdad the morning of April 7. According to the general, Saddam and Qusay were aware at that point that the Special Republican Guard and Republican Guard troops assigned to protect the main palace complex had deserted. When informed that an American armored column was advancing toward Baghdad’s strategic Jumhuriya Bridge, Saddam ordered 12 pickup trucks of Fedayeen Saddam to the bridge to repel the column. “Imagine,” said the general, “a few pickup trucks against two battalions” of U.S. tanks and Bradley fighting vehicles.¹⁹⁸

Over the next two days Saddam continued to evade capture, moving from one safe house to another. His remaining regular military forces, Ba’ath Party and Fedayeen Saddam militiamen, and their various commanders evaporated. By the time Saddam abandoned the city in a white Oldsmobile heading north on the morning of April 10, there was no longer anything in Baghdad for him to command.¹⁹⁹ As Captain Khalidi, the Republican Guard officer, summarized it:

In the end, when [U.S. troops] entered Baghdad, everything was messed up. . . . There were no orders. We didn’t know where the commanders went. We didn’t know what to do. So everyone just went home.²⁰⁰

¹⁹⁶According to the Iraqi report, the counterattack had killed 400 U.S. soldiers, captured 200 prisoners, and destroyed 80 U.S. tanks and other fighting vehicles. See Branigin, p. A25.

¹⁹⁷Zucchino, “Iraq’s Swift Defeat,” p. 1.

¹⁹⁸The Republican Guard general who reported on the meeting answered questions relayed by an aide and refused to allow his name to be used because he feared he would be arrested by U.S. occupation forces. See Zucchino, “Iraq’s Swift Defeat,” p. 1.

¹⁹⁹Accounts of Saddam’s last days in Baghdad are provided by his and his son Uday’s bodyguards. See “Treachery: How Iraq Went to War Against Saddam.”

²⁰⁰Branigin, p. A25.

Superior Military Capabilities Gave Coalition Forces an Overwhelming Advantage

The coalition's domination of the battlefield in OIF was also due to its capability to deploy highly trained and motivated fighting forces, gain air supremacy, find targets and strike them promptly with accurate aerial and ground firepower, and advance ground forces rapidly and sustain them over long distances. The coalition's objective of securing a prompt, low-casualty takedown of Saddam's regime was also facilitated by a battle plan that identified Baghdad as the Iraqi regime's center of gravity and that provided for a scheme of maneuver that would allow American forces to seize the capital rapidly.²⁰¹

In virtually every aspect of the fighting, coalition forces demonstrated a marked superiority over their Iraqi opponents. The discrepancy in capability was most telling in the ability of the coalition's ground and air forces to deliver accurate, lethal fire on Iraqi targets.

In some instances the weight of the U.S. firepower caused the Iraqi defenders to melt away. An Iraqi regular army lieutenant colonel, Mahmood Sharhan, described his reaction to the Marine Corps bombardment he experienced near the Diyala River at the eastern boundary of Baghdad:

It was every man for himself. You just had to make your own decisions. The bombardment was so heavy, and it made no attempt to distinguish between civilian and military areas.²⁰²

The accurate and withering firepower of U.S. air and ground forces took a huge toll on those Iraqi soldiers and militiamen who attempted to resist. Mohamed Shebab, a Fedayeen Saddam fighter who participated in the vicious hour-and-a-half firefight with U.S. forces at the International Airport, described the one-sided nature of that battle:

The fighting was fierce. They had planes and tanks, and all we had were machine guns, rocket-propelled grenades and hand grenades . . . We had to withdraw. We just couldn't stand up to them. There were only about 25 of us left. Most of the Fedayeen were killed.²⁰³

²⁰¹ See Fontenot, Degen, and Tohn, pp. 45–52.

²⁰² Transcript of the episode of the PBS program *Frontline* entitled “The Invasion of Iraq,” first aired February 26, 2004. As of August 2007:
<http://www.pbs.org/wgbh/pages/frontline/shows/invasion/etc/script.html>

²⁰³ Transcript of the episode of the PBS program *Frontline* entitled “The Invasion of Iraq,” first aired February 26, 2004. As of August 2007:
<http://www.pbs.org/wgbh/pages/frontline/shows/invasion/etc/script.html>

The availability of close air support (CAS) allowed numerically inferior U.S. and allied forces to defeat larger Iraqi units. Once the outnumbered U.S. special operations forces and Kurdish peshmerga militia fighters in northern Iraq began to receive air support, they began to make gains against Iraqi divisions defending along the Green Line. Air support was also critical to the success of Operation VIKING HAMMER—the mission to destroy the Ansar al-Islam terrorist base in northern Iraq.²⁰⁴

When Iraqi forces threatened to overrun the U.S. unit holding the newly captured bridge at Objective MONTY on the northern outskirts of Baghdad on April 6 and 7, the U.S. unit's commander called for his "supporting artillery to fire his final protective fire (FPF)" along a previously designated line just outside his position.²⁰⁵ The resulting combination of continuous rapid U.S. artillery fire, close air support strikes, and direct fires "stopped the enemy cold."²⁰⁶

The Iraqis mounted their largest offensive operation of the war on the night of April 3–4, in a belated attempt to destroy the U.S. forces that gained a lodgment on the eastern side of the Euphrates River near the bridge at Objective PEACH.²⁰⁷ General Al-Hamdani, the Republican Guard II Corps commander, mounted a counterattack along three axes, using armor, artillery, and infantry elements of the 10th Armored Brigade of the Republican Guard Medina Division, the Special Forces 3rd Brigade, and the Republican Guard Nebuchadnezzar Infantry Division.²⁰⁸ All told, the attacking Medina armored force consisted of some 15 tanks and 30 to 40 armored personnel carriers, supported by artillery mortars.²⁰⁹

General Al-Hamdani, who had fought in five previous wars and who had "joined the front lines in [the] battle" at Objective PEACH, claimed that his men "had high spirits and a strong will to fight" because he had told them that the "honor of Iraq and the fate of Baghdad" were at stake.²¹⁰ But this all came to naught when "a fierce battle took place":

²⁰⁴See Murray and Scales, pp. 190–193.

²⁰⁵Final protective fires are called for only "if the defense gets desperate." The fight at Objective MONTY was the only occasion when FPF was called for in OIF. See Fontenot, Degen, and Tohn, pp. 375–376.

²⁰⁶Fontenot, Degen, and Tohn, p. 376.

²⁰⁷The engagement at Objective PEACH receives extensive treatment in Chapter Four.

²⁰⁸*Frontline* interview with Lieutenant General Al-Hamdani.

²⁰⁹Transcript of interview with Lieutenant Colonel Ernest "Rock" Marcone, battalion commander of the 69th Armor of the 3rd Infantry Division's 1st Brigade, for an episode of the PBS program *Frontline* entitled "The Invasion of Iraq," first aired February 26, 2004. As of August 2007: <http://www.pbs.org/wgbh/pages/frontline/shows/invasion/interviews/marcone.html>

²¹⁰Al-Hamdani, however, also admitted he had "a mistaken idea that our forces will fight with high spirit and for [a] long time." *Frontline* interview with Lieutenant General Al-Hamdani.

The enemy used enormous firepower. It looked like napalm. Rocket launchers would fire groups of rockets, about 12 rockets each, that would explode in the air, burning whatever it faces on its way with flames. . . .

The battle that took place didn't look even like action movies, because events were so fast. I didn't have a single tank intact; it was either damaged or destroyed. I didn't have a single vehicle left. The battle reached a point where the army commander [myself] was fighting with a machine gun. The groups of command and communication were completely destroyed. . . .

From the dawn . . . until sunset, the Air Force destroyed anything that moved. Then the Americans broke through fiercely, as if it was programmed. Anything that moved was hit by tanks, armored vehicles, Apaches, and jet fighters, whether it was civilian or military, Republican Guard or not . . . The amount of fire and destruction was beyond description.²¹¹

General Al-Hamdani then attempted to salvage what was left of the Medina Division but found that “there was no solid force left.” He made an abortive attempt to collect stragglers, but encountered “total chaos. No officer could gather forces to do anything.”²¹² After hiding in a palm grove for a number of days, General Al-Hamdani returned to his family in Baghdad.

Iraqi forces were also disadvantaged by the fact that U.S. forces could see and kill them at night. The Iraqis lacked sufficient night-vision devices for their tanks as well as for their troops. Moreover, the Iraqis did not understand the capabilities of American night-vision optics, particularly the capability provided by night-vision scopes wedded to laser target designators. As a consequence, Iraqi and jihadist forces were sometimes “wholly unaware that they could be observed through American night optics.”²¹³

American commanders in OIF emphasized the importance of maintaining a fast pace in the advance of their forces. As the CFLCC commander, Lieutenant General McKiernan, described his “intent” from the very beginning of the invasion: “Fast is more lethal than slower. Fast is more final.”²¹⁴ The combination of rapidly moving U.S. forces and poor Iraqi situational awareness, which was partly a product of that fast movement, undermined the Iraqi ability to mount a coherent defense and demoralized them.

A concrete example of such demoralization occurred on April 4 when elements of the 2nd Brigade, 3rd Infantry Division simultaneously attacked—from the rear—

²¹¹ *Frontline* interview with Lieutenant General Al-Hamdani.

²¹² *Frontline* interview with Lieutenant General Al-Hamdani.

²¹³ For accounts of the battlefield advantages that night-vision optics gave an American Marine Corps Recon unit in OIF, see Evan Wright, *Generation Kill*, New York: G.P. Putnum's Sons, 2004, pp. 119, 217, 241–243, and 250.

²¹⁴ *Frontline* interview with Lieutenant General McKiernan.

elements of two Republican Guard Medina Division brigades that were dispersed in palm groves and towns along Routes 1 and 8 south of Baghdad. The 2nd Brigade commander approaching from the north fell upon hundreds of Medina Division armored vehicles, artillery pieces, and other combat equipment that were oriented mostly toward south. The Iraqis were obviously caught by surprise, and the enemy tanks and BMPs that attempted to turn around and fight were quickly destroyed.

Most of the fighting that occurred with the Medina Division and in Baghdad involved engagements with individual armored vehicles and small enemy troop elements, rather than with cohesive and coordinated larger units. General Omar Abdul Karim, an Iraqi regular army commander, confirmed the effects of the fast U.S. armor assault on the forces attempting to defend Baghdad:

We weren't prepared, but it didn't matter because the tank assault was so fast and sudden. The Americans were able to divide and isolate our forces. Nobody had any idea what was going on until it was too late.²¹⁵

Concluding Observations

Four issues relating to OIF deserve further discussion: (1) how the speed and costs of Saddam's takedown closely tracked prewar predictions; (2) how the extreme weakness of the Iraqi resistance undermines the validity of lessons about military strategy and force sizing that can be drawn from OIF; (3) how Iraqi behavior in OIF and coalition decisions before and immediately after the conflict paved the way for the insurgency that followed; and (4) how OIF may influence the behavior of future adversaries.

The Coalition's Victory Was Achieved Rapidly and at a Low Cost

In terms of the immediate coalition objective of bringing down Saddam Hussein's regime, OIF was a manifest success. Victory was achieved rapidly and at a comparatively small cost in friendly casualties, both important measures of battlefield accomplishment. The ease with which the takedown was accomplished was not a surprise to senior U.S. military leaders, as it occurred within the timelines they had forecast.²¹⁶

²¹⁵ See Zucchino, "Iraq's Swift Defeat," p. 1.

²¹⁶ When asked by Secretary of Defense Rumsfeld for their estimates of how long it would take to achieve regime change, General Myers, the Chairman of the Joint Chiefs of Staff (JCS), reportedly replied that he thought U.S. forces would get to Baghdad in about two to three weeks, and would take about "30 days in all." General Pace, the Vice Chairman of the JCS, estimated that it would take less than a month, assuming U.S. intelligence about likely large-scale Iraqi capitulations was accurate. General Franks, the CENTCOM commander, said the time required to take down the regime would be measured in "weeks not months." The most optimistic of those responding was Paul Wolfowitz, the Deputy Secretary of Defense, who estimated that Saddam's regime would be brought down within seven days. See Woodward, pp. 325–326.

Decisionmakers Should Be Careful About the Lessons They Draw from OIF

Military and civilian decisionmakers should be careful not to draw the wrong lessons from OIF, particularly with respect to the U.S. force structure that may be needed for future conflicts.²¹⁷ Decisionmakers should also be cautious about extrapolating strategic lessons from OIF, such as whether invasions can be conducted at minimal cost in U.S. casualties in the absence of extended preparatory air campaigns. The extraordinary battlefield advantages that coalition forces enjoyed in Iraq during March and April of 2003 may not be replicated in future conflicts.

First, the Iraqi military proved to be an extremely weak and inept foe. The Iraqi defense was poorly led, planned, organized, and executed. Iraqi troops manifested a lack of adequate training in even the most basic military arts and were equipped with weapons markedly inferior to those possessed by the coalition. Most importantly, most of the officers and rank-and-file in both the Republican Guard and regular army lacked the will to fight and deserted the battlefield before being engaged by coalition ground forces.

While many of the Iraqi military shortcomings evident in OIF paralleled those observed 12 years earlier in DESERT STORM, the Iraqi military establishment that the coalition faced in OIF was substantially more debilitated and hollow than was the enemy the United States and its allies faced in 1991. So too, the U.S. capability to inflict lethal precision strikes on enemy forces was substantially greater in OIF than was the case in DESERT STORM. As a consequence, the imbalances in the correlation of forces that had so greatly disadvantaged the Iraqi side in the 1991 Persian Gulf War became even more pronounced in OIF. An Iraqi battlefield performance that was poor in 1991 was even worse in 2003.

Second, the coalition benefited greatly from both what Saddam Hussein did and did not do in the run-up to and conduct of OIF. The Iraqi leader's strategic misjudgments, propensity to focus on internal threats, poor defensive schemes and command appointments, and inept battlefield management significantly weakened the Iraqi military's capability to mount even a semblance of an effective defense. Indeed, it is hard to think of other actions that Saddam might have taken, short of unconditional surrender, that would have proven more beneficial to the coalition cause than the policies and practices that he actually adopted.

But what Saddam did not do was perhaps even more important. Had the Iraqi leader held a less benign view of the coalition's intentions and recognized early on that his regime was in serious peril, he might have adopted scorched-earth tactics and other

²¹⁷ When asked how valid it would be to draw lessons from OIF, Lieutenant General Conway responded: "I think we'd better be careful drawing lessons from the whole of the effort, if you will. I'd have cautioned our headquarters and our decision-makers that this is probably an anomaly, both for the Marine Corps and perhaps for the nation. . . I also think that we should not formulate changes to the force structure based on what has now been a couple of fights against Iraqis. I don't think [they had a] terribly efficient army. I think both the Gulf War and this Operation Iraqi Freedom will show us that." *Frontline* interview with Lieutenant General Conway.

courses of action that could have increased the costs of OIF to both the coalition and the Iraqi people.

Had Saddam taken such actions, the fighting in OIF would have been more protracted and coalition casualties would no doubt have been higher. The systematic dropping of bridges, inundating of the countryside, and torching of oil fields also would have significantly increased the costs of postwar reconstruction in Iraq. The latter two actions, of course, also would have caused significant damage to Iraq's environment.

However, none of these actions would likely have prevented a coalition victory or saved Saddam's regime. Nor would an improved Iraqi battlefield performance or a less well-executed coalition campaign have changed the outcome. The coalition superiority in OIF was such that there was a large margin for error in the takedown phase of the operation.

Some Iraqi senior officers believed they could and should have prolonged the fight.²¹⁸ But they readily acknowledged the ultimate futility of attempts at resistance. As the former Iraqi defense minister saw it:

Even if Iraq's military performed better during Operation Iraqi Freedom, Iraq would only have increased the number of coalition casualties without altering the war's outcome.²¹⁹

OIF and Its Immediate Aftermath Paved the Way for the Insurgency That Followed

Despite speculation to the contrary, Saddam did not plan for a protracted guerrilla war after an Iraqi defeat in the conventional conflict.²²⁰ As previously noted, Saddam did not believe his regime would be overthrown or that coalition forces would seize Baghdad. Instead, he believed his forces would be able to hold out long enough to build political pressures sufficient to cause the coalition to accept a political solution that would leave him in power.²²¹ Saddam was probably as surprised as any Iraqi when U.S. forces entered Baghdad.²²² He attributed the collapse of the Iraqi defenses to "betrayal," a charge that was echoed by his daughter Raghad.²²³

²¹⁸As Al-Hamdani put it: "We might have fought for [a] longer time and could have delayed the enemy and forced him to pay [a] heavy price, so as to have justice for the Iraqi people and armed forces from [a] historic point of view." *Frontline* interview with Lieutenant General Al-Hamdani.

²¹⁹Duelfer, p. 32.

²²⁰Investigators considered the possibility that Saddam all along intended to make a strategic withdrawal and fight a guerrilla war, but they said they could find no evidence of such a strategy from interrogations or documents. See Moore, "A Foe That Collapsed from Within," p. A1. See Coll, 2003, p. A1.

²²¹Duelfer, p. 68.

²²²The Iraqi leader was surprised by swiftness of the Iraqi defeat. See Duelfer, p. 68.

²²³Transcript of *Frontline*, "The Invasion of Iraq." Saddam's daughter Raghad asserted in a postwar interview in Jordan that the rapid fall of Baghdad was due to "treason" in high places. As she described it: "Regrettably, the

Although not prompted by considerations of a postwar resistance, a number of Iraqi actions prior to and during OIF helped to facilitate and shape the insurgency that emerged in Iraq. These included:

- The large-scale arming of Ba'athist and tribal loyalists prior to OIF. Saddam expected these loyalists to employ guerrilla tactics to oppose any invading forces' attempts to occupy Iraq's cities and towns. The provision of additional weapons to these groups increased the pool of armed regime loyalists who could later fight against coalition occupation forces and against a new Iraqi government.
- The widespread dispersal of munitions and weapons stockpiles so as to reduce their vulnerability to destruction by coalition bombing. These prewar dispersals, combined with those that had taken place previously, ensured that weapons and explosives would be easily obtainable throughout the country.
- The release of large numbers of criminals from Iraqi prisons shortly before the war. These criminal elements have contributed to the general lawlessness that now pervades Iraq and, in some cases, have also actively participated in the insurgency.
- The movement into Iraq of thousands of foreign jihadists from a number of Middle Eastern and other countries to join the armed struggle against the coalition invasion. Some of these foreign jihadists survived the war and probably remained in Iraq to fight the occupation.²²⁴ Building on this earlier precedent, jihadists continued to be recruited in foreign lands and infiltrated into Iraq across its porous borders.
- The existence of a body of Iraqis—principally the Fedayeen Saddam militiamen—who were sufficiently committed to Saddam's regime and opposed to the coalition's invasion of Iraq to mount suicidal or near-suicidal attacks against U.S. forces. It seems likely that at least some of the committed fighters survived the war and took up arms again against the occupation.²²⁵ It was also in OIF that Iraqis first demonstrated their willingness to conduct suicide attacks against U.S. personnel and vehicles with vehicular-borne improvised explosive devices (VBIEDs), a practice that remains common in Iraq.²²⁶

people in whom he placed his full trust and whom he considered his right-hand men were the main sources of treason." See "Al-Arabiya TV Interviews Saddam's Daughter Raghda," Dubai Al-Arabiya Television in Arabic, August 1, 2003. FBIS Document ID: GMP200308011000231.

²²⁴Some jihadists were unable to return to their home countries because they lacked the money for the trip or because they were without passports that had been taken from when they entered Iraq. See Stalinsky.

²²⁵According to some former Iraqi military sources, the Ba'ath Party and Fedayeen Saddam militiamen and the foreign jihadists who had regrouped after the fall of Baghdad were behind most of the attacks against U.S. forces in 2003. See Moore, "A Foe That Collapsed from Within," p. A1.

²²⁶The 3rd Infantry Division and the Marine Corps suffered a number of casualties from car bomber attacks. The Marine Corps also had a tank knocked out by this means of attack. *Frontline* interview with Lieutenant General Conway.

- Finally, and most important, the fact that by the war's end, the entire Iraqi military, security, and governmental structure had dissolved. Hundreds of thousands of former Iraqi military and civilian personnel, including Saddam and his key associates, abandoned their posts and either returned home or went into hiding. Among these were numerous former military officers, security and intelligence persons, and Ba'athist officials who possessed the skill, resources, and motivation to mount and sustain a robust resistance against the coalition occupation.²²⁷ The coalition was able to identify and incarcerate only a small fraction of these potential oppositionists.

U.S. Assumptions and Actions Also Fueled the Insurgency

Certain assumptions and decisions that were adopted by U.S. leaders both prior to and following the conventional fighting also facilitated and fueled the growth of the insurgency in Iraq.

Perhaps the most important of these was the decision to invade and occupy Iraq with a limited-sized force. Central to the “decision to limit the amount of combat power deployed into the theater” was the fundamental assumption that “the Iraqi military would not resist.”²²⁸ There was a corollary assumption that a limited force would also be capable of handling any postwar contingencies that might arise.

Paul Wolfowitz, then the Deputy Secretary of Defense, voiced this view in his testimony before Congress on March 27, 2003:

But some of the higher-end predictions that we have been hearing recently, such as the notion that it will take several hundred thousand U.S. troops to provide stability in post-Saddam Iraq, are wildly off the mark. First, it's hard to conceive that it would take more forces to provide stability in post-Saddam Iraq than it would take to conduct the war itself and to secure the surrender of Saddam's security forces and his army. Hard to imagine.²²⁹

But Saddam's forces did not behave in the manner Secretary Wolfowitz and others had expected. Indeed, a number of the developments that accompanied the demise of Saddam's regime clearly were not anticipated by U.S. military and civilian leaders. The U.S. leaders had expected large-scale Iraqi surrenders, a welcoming Iraqi public, and

²²⁷Among those at large were former members of the Al Ghafiqi Project (M21 Directorate) of the Iraqi Intelligence Service (IIS), commonly known as the Mukhabarat. The Al Ghafiqi Project existed to make IEDs and other explosive devices for the IIS to use in assassination and demolition operations. See Duelfer, p. 81.

²²⁸See Fontenot, Degen, and Tohn, p. 69.

²²⁹Transcript of *Frontline*, “The Invasion of Iraq.”

at least some elements of the Iraqi government to remain in place.²³⁰ Instead, the vast bulk of Iraqi military and security forces choose to desert rather than surrender; much of the Iraqi public, while pleased to see Saddam depart, proved reluctant to embrace a foreign occupation; and the governmental structure throughout the non-Kurdish areas of Iraq totally dissolved.

Similarly, U.S. leaders were obviously also surprised by the massive looting that broke out in Baghdad and other regions of the country at the end of conventional fighting. That this was unexpected is in itself surprising in that the last U.S. military take-down of a regime, the 1989 ouster of Noriega in Panama, was also followed by massive looting that was hugely costly to the Panamanian economy.²³¹

The looting, which began on a small scale, quickly escalated and got out of hand as U.S. forces were slow to attempt to stop it, partly because they initially had no orders to do so, and partly because the United States and its coalition partners lacked sufficient forces in Iraq to adequately police the country.²³² The task of imposing control was also impaired by the dearth of military police in the occupation force.²³³ Clearly,

²³⁰For expectation about large numbers of enemy prisoners of war in Iraq, see Fontenot, Degen, and Tohn, p. 69. For CIA expectations that the Iraqi public would warmly greet U.S. troops, see “CIA Expected Iraqis to Wave U.S. Flags After Invasion,” Associated Press, October 20, 2004.

²³¹The Panama looting was a surprise to General Max Thurman, the SOUTHCOM commander, who said he would have brought more military police forces into Panama during Operation Just Cause had he anticipated it. According to one account, the losses from the looting in Panama ranged from “\$1 billion to \$2 billion.” See Richard H. Shultz, Jr., “The Post-Conflict Use of Military Forces: Lessons from Panama, 1989–91,” *Journal of Strategic Studies*, June 1993, p. 154.

²³²According to Todd Purdum of the *New York Times*, “When Iraqis would ask U.S. forces why they weren’t trying to stop the looting, the answer was clear. They just didn’t have enough people; they couldn’t do it.” When Thomas Ricks of the *Washington Post* asked members of the 3rd Infantry Division in Baghdad why they hadn’t moved against the looters, he was told that they had “basically stayed in their fighting positions” because “they had no orders to do anything else,” and because they felt “under-resourced.” “They were tired, they just fought a war. They didn’t have a lot of people. Even if you want to establish a presence, a city of 5 million will soak up 20,000 soldiers. So they really were not prepared to do the larger mission of presence, that ultimately was needed.” *Frontline* interviews with Todd Purdum and Thomas E. Ricks. Lieutenant General Jay Garner (USA ret.), who arrived in Baghdad on April 21, 2003, to head the first occupation government in Iraq, stated in a November 2003 interview with the BBC that “If we did it over again, we probably would have put more dismounted infantrymen in Baghdad and maybe more troops there.” See “Jay Garner’s November 25th Interview with the BBC,” Associated Press, November 26, 2003.

²³³Prewar planning did not envision using military police (MP) to guard Iraqi government facilities or control the Iraqi population. Their “specified and implied tasks” were to include “EPW operations, high-value asset (HVA) security, area security operations, and main supply route (MSR) regulation and enforcement.” However, the available manning for even some of these tasks was reduced when “it became obvious that there would be significantly fewer MP units in-theater when the war started than originally planned based on the new force packaging decisions.” See Fontenot, Degen, and Tohn, p. 70.

the absence of an “overwhelming” U.S. military presence in country when Saddam’s regime collapsed allowed widespread lawlessness to take root.²³⁴

The major effects of the looting appear to have been fourfold: (1) it made the reconstruction of Iraq significantly more difficult and costly, (2) it resulted in a radical decline in the quality of life for Iraqis, (3) it shook the Iraqi public’s confidence in the American occupation, and (4) it gave encouragement and momentum to elements who would actively oppose the coalition occupation.²³⁵

The looting also helped to give rise to another U.S. decision that appears to have abetted the growth of the resistance: the May 23, 2003 Coalition Provisional Authority (CPA) decision to dissolve all Iraqi military organizations.²³⁶ Part of the rationale for this decision was the enormous damage done to Iraqi military facilities by civilian and military looters. CPA officials argued that if they had attempted to call back members of the former Iraqi forces, there would have been no place to house them.²³⁷

Retired Lieutenant General Jay Garner, former director of the office of Reconstruction and Humanitarian Assistance (ORHA), which was originally responsible for the postwar administration in Iraq, believes the decision to disband the Iraqi army “was a mistake . . . We planned . . . on bringing the Iraqi army back and using them in reconstruction.” In Garner’s view, the CPA’s decision to disband the military threw hundreds of thousands of Iraqi breadwinners out of work and provided a body of potential recruits for the insurgency.²³⁸

Some Sunnis and former regime members undoubtedly were also strongly alienated by the CPA’s order of May 16, 2003 that mandated the de-Ba’athification of Iraqi society. Under this order, full members of the Ba’ath Party were banned from any public

²³⁴See the statement of Thomas White, Secretary of the Army 2001–2003, in the transcript of *Frontline*, “The Invasion of Iraq.”

²³⁵*Frontline* interview with Ricks. For views on the effects of looting and lawlessness, see the *Frontline* interviews with former Secretary White and Todd Purdum.

²³⁶See Coalition Provisional Authority, “Order Number 2: Dissolution of Entities,” May 23, 2003. All of the CPA’s orders are available at a website, no longer updated, that has been left open for historical purposes. As of August 2013:
<http://www.iraqcoalition.org/regulations/#Orders>

²³⁷As Walter Slocombe of the CPA described it: “When the Iraqi army took off for home, its soldiers took any gear of possible worth along with them—not just military equipment but trucks, furniture and everything of any use. What the fleeing soldiers did not take, the civilian population looted from abandoned bases and camps. Looters and scavengers literally took not just the kitchen sinks but the pipes from the walls and the tiles that covered the kitchen floors. Rehabilitating these facilities for use by coalition forces or by new Iraqi security organizations has taken months of hard work and millions of dollars. Had a recall somehow evoked a response, we would have found ourselves not with 500,000 disciplined soldiers ready to impose order under U.S. command but with 500,000 refugees needing shelter, food, uniforms, weapons and a good many other things—just to survive. Instead of being a help to the American and other forces, they would have been a huge burden.” See Slocombe, p. A29.

²³⁸“Jay Garner’s November 25th Interview with the BBC.”

employment, including service in the new Iraqi army. Senior party members were also “to be evaluated for criminal conduct or threat to the security of the coalition.”²³⁹

While some level of de-Ba’athification was obviously necessary to bring about regime change in Iraq, the May 16 order probably went too far. Garner, the former chief of ORHA, disagreed with the order, believing that it encompassed too many Ba’athists. He told L. Paul Bremer, the head of the Coalition Provisional Authority (ORHA’s successor organization), that the action would drive from 30,000 to 50,000 Ba’athists underground.²⁴⁰ Although the actual effect may have been less severe than General Garner feared, the de-Ba’athification order undoubtedly was an additional reason for some former regime elements to take up arms against the coalition.

All this said, even if the United States had sent larger forces to Iraq and had not disbanded the Iraqi military, and indeed had taken other actions to dissuade potential opposition such as holding early elections, some degree of armed resistance in Iraq was probably inevitable. The number of former regime elements at large after the war, with the motivation and capability to attack U.S. forces, was sufficient in itself to ensure some armed opposition. There were also numerous other Iraqis who were motivated to oppose the occupation and any Iraqis who aligned themselves with it. These included the Sunni tribal members who resented losing the ascendant position they once enjoyed under Saddam’s rule and the Iraqis who considered it their nationalist or religious duty to actively oppose the occupation of their country.

However, a substantially larger U.S. military force could have restricted the looting, guarded munitions sites and borders, and significantly dampened the lawlessness that swept over Iraq. These and other actions aimed at preempting and reducing opposition probably could have prevented the insurgency from gaining as strong a foothold in Iraq as it came to enjoy.

How OIF May Influence the Behavior of Future U.S. Adversaries

Commenting on the devastating conventional defeat the United States had inflicted on Iraq in the 1991 Gulf War, an Indian minister of defense once famously observed: “Don’t fight the United States unless you have nuclear weapons.”²⁴¹ The defense min-

²³⁹The order encompassed “full members of the Ba’ath Party holding the ranks of ‘Udw Qutriyya (Regional Command Member), ‘Udw Far’ (Branch Member), ‘Udw Shu’bah (Section Member), and ‘Udw Firqah (Group Member) (together, ‘Senior Party Members’) . . .” See Coalition Provisional Authority Order Number 1: De-Ba’athification of Iraqi Society, May 16, 2003. The extension of the de-Ba’athification order to service in the new Iraqi army is contained in Coalition Provisional Authority Order Number 22: Creation of a New Iraqi Army, August 18, 2003. All of the CPA’s orders are available at a website, no longer updated, that has been left open for historical purposes. As of August 2013:

<http://www.iraqcoalition.org/regulations/#Orders>

²⁴⁰Interview with Jay Garner, Chief of ORHA, March 23, 2004.

²⁴¹Quoted in Representative Les Aspin, House Armed Services Committee Memorandum: “From Deterrence to Denuking: Dealing with Proliferation in the 1990s,” Washington, D.C.: GPO, February 18, 1992.

ister's meaning, of course, was that a nuclear deterrent was needed if a country was to ward off submitting to coercion or catastrophic defeat by technologically advanced U.S. military forces. Indeed, this was one of the reasons Saddam Hussein wanted nuclear weapons.²⁴²

Given the rout of Iraqi forces in 2003, countries that consider themselves to be potential future military adversaries of the United States are likely to share this view. In this sense OIF may constitute a spur to nuclear proliferation in countries such as Iran or North Korea. However, OIF also carried another lesson for potential adversaries, namely that the United States is willing to take military action, including the take-down of hostile governments, to prevent "rogue" states from acquiring or possessing WMD. This was the lesson Colonel Qaddafi apparently absorbed when he decided to abandon Libya's WMD programs.²⁴³

Another major downside lesson that potential adversaries should draw from OIF is that their armor, mechanized, and infantry forces—even if modernized—cannot effectively fight U.S. ground forces, so long as U.S. forces have air supremacy. The dilemma facing enemy commanders (and one that some Iraqi commanders well understood) is that if they disperse their armor, artillery, and other heavy weapons to reduce their vulnerability to U.S. air attack, they will lack the mass to withstand U.S. armored attacks. But if they concentrate their heavy weapons, they will risk rapid attrition from U.S. air attacks. As a consequence, enemy leaders can be expected to attach high priority to devising ways to deny U.S. forces air supremacy or, at least, to reduce the adverse effects of that supremacy.

Enemy leaders may also draw one other important lesson from OIF: the potential political-military utility of possessing a capability to wage insurgent warfare against U.S. invasion and occupation forces. To develop such a capability, enemy leaders would organize, train, and equip ground units for guerrilla-style warfare and position hidden weapon and munitions caches throughout their country. Selected members of the public would also be organized, motivated, and trained to support resistance warfare, if the need should arise.

Enemy leaders may calculate that the very prospect of becoming bogged down in a protracted guerrilla conflict might serve to deter U.S. leaders from mounting an invasion. If deterrence failed, then protracted insurgency might be a promising strategy

²⁴²Saddam considered nuclear programs as essential to obtaining political freedom at the international level and to "compete with powerful and antagonistic neighbors; to him nuclear weapons were necessary for Iraq to survive." In a conversation (of an unknown date) with Tariq Aziz and other senior officials, Saddam opined, "The existence of the nuclear weapons in other countries makes the USA and Europe get worried. Having nuclear weapons in these areas, with their economic situation known by the US, gives these countries a chance to face the European countries and the Americans." See Duelfer, p. 26.

²⁴³Other factors also influenced Qaddafi's decision, particularly his concern to rid Libya of the international sanctions that had been preventing foreign investment in Libya and inhibiting the modernization and expansion of its petroleum industry.

for imposing sufficient costs on the occupiers to force the United States to withdraw or agree to a political settlement acceptable to the enemy's leadership.²⁴⁴

²⁴⁴America's adversaries in all major wars from World War II onward have counted on protracting the fighting and exacting sufficient U.S. casualties to the point where the U.S. public would turn against a continued military involvement and force a political solution advantageous to the adversary.

Managing the War

*Walter L. Perry, Edward O'Connell, Miranda Priebe,
Alexander C. Hou, Lowell H. Schwartz*

An operation the size and scope of Operation IRAQI FREEDOM required the participation of elements from most U.S. military organizations, the CIA and other U.S. government agencies, coalition partners, and friendly nations in the region. The functions performed included everything from detailed operational planning and execution of combat to humanitarian assistance and post-conflict governance. To manage all of this in OIF required the creation of several organizations complete with detailed command relationships and a complex array of operational processes and procedures. All of these required complex communications connectivity, multiple layers of liaison officers, innovative ad hoc relationships among battlefield entities, and commanders who were not only good leaders but skilled managers as well. Nevertheless, everything did not always go as well as expected.

The military organizations participating in OIF were either under the command of the CENTCOM commander or controlled by him. A total of seven U.S. task organizations, 24 supporting organizations, several allies, and other government agencies participated in OIF. Table 7.1 lists the major U.S. organizations that directly participated in the conflict or served in a support role. The relationships among these organizations, coalition partners, nongovernmental organizations, and international organizations illustrate the complexity of the command and management structure and mechanisms created for OIF.

The Lessons of Afghanistan

Planning for OIF began while the war in Afghanistan was still in progress.¹ Naturally the lessons gained from the command and control arrangements used to prosecute that war would influence planning for operations in Iraq. The command and control arrangements for Operation ENDURING FREEDOM were complex simply because

¹ See Chapter Three. Serious planning for operations in Iraq began in early December 2001, just as operations at Tora Bora were under way.

Table 7.1
Organizations Participating in Operation IRAQI FREEDOM

Task Organizations

U.S. Central Command	CENTCOM
U.S. Army Forces Central Command	ARCENT
U.S. Central Command Air Forces	CENTAF
U.S. Marine Forces Central Command	MARCENT
U.S. Special Operations Command Central	SOCCENT
U.S. Naval Forces Central Command	NAVCENT
Joint Psychological Operations Task Force	JPOTF

Supporting Organizations

Central Intelligence Agency	CIA
Defense Intelligence Agency	DIA
Defense Courier Service	DCS
Defense Information Systems Agency	DISA
Defense Logistics Agency	DLA
Defense Security Assistance Agency	DSAA
Department of State	DOS
Department of the Army	DA
Department of the Navy	DON
Department of the Air Force	DAF
Department of Transportation	DOT
Federal Aviation Administration	FAA
Federal Bureau of Investigation	FBI
Joint Chiefs of Staff	JCS
National Imagery and Mapping Agency	NIMA
National Security Agency/Central Security Services	NSA/CSS
U.S. Joint Forces Command	USJFCOM
U.S. Space Command	USSPACECOM
U.S. Special Operations Command	USSOCOM
U.S. Strategic Command	USSTRATCOM
U.S. European Command	USEUCOM
U.S. Transportation Command	USTRANSCOM
U.S. Pacific Command	USPACOM
United States Information Agency	USIA

of the large number of organizations participating. In addition to the several military organizations, the CIA participated along with a long list of coalition partners, indigenous forces, and international and nongovernmental relief organizations.

In ENDURING FREEDOM, General Franks decided not to deploy his headquarters forward, nor did he deploy a Joint Task Force, for these reasons: (1) there was no standing organization that could be drawn upon to create a joint headquarters at any level below the combatant command; (2) his command was one of the few that included forward-deployed component command facilities; and (3) modern informa-

tion technology gave him sufficient situational awareness, even from Tampa.² Because of the need to respond to the 9/11 attacks quickly, the first of these reasons drove his decision. There was no time to create, train, and deploy a headquarters capable of directing all of the activities of the combined force. For OIF, General Franks had sufficient time to plan the deployment of his command headquarters. He began assembling a deployable headquarters as early as December 2001.

The absence of a command element in Afghanistan meant that all decisions concerning the combined force had to be made outside the area of operations, sometimes in Tampa. On occasion, this caused serious problems; for example, conducting videoconferencing and telephonic meetings when several parties were seven times zones away, or determining who was in charge of operations in Afghanistan when SOF, conventional and coalition forces, and the CIA were all conducting operations.

Implications for Operation IRAQI FREEDOM

Although operations in Iraq were significantly different from those in Afghanistan, the problems encountered in controlling the force were likely to persist unless some modifications were made to command and control procedures. Even though the number of coalition partners was considerably reduced in OIF, the constraints placed on commanders in using coalition forces were still applicable. And the relationships among the conventional forces, special operations forces, and CIA elements were still to pose command and control challenges. A central question then is: What was done differently, and how effective was the change.

OIF involved a single chain of command. As in Afghanistan, General Franks chose not to establish a combined joint forces headquarters and elected to control U.S. and coalition forces through his component commanders. However, unlike Afghanistan, he did so from his forward headquarters in Qatar.

In OIF, special operations forces were unified under a single command, the Combined Forces Special Operations Component Command's Combined Joint Special Operations Task Force (CJSOTF), headed by Brigadier General Gary Harrell. Harrell had participated in operations in Afghanistan and was concerned at the lack of a unified command for special operations forces there. Furthermore, he experienced first hand the control problems associated with conventional and special operations forces operating in the same area of operations. Operational necessity, however, required that CJSOTF be given responsibility for conducting operations in northern Iraq. As a result, Harrell exercised operational control of Marine Corps and Army conventional

² Interview with General Tommy Franks, Commander, U.S. CENTCOM, November 2001.

forces. Coordination between SOF units throughout the Iraq theater of operations and CIA teams was much improved because of the extensive use of liaison officers.³

Unlike ENDURING FREEDOM, General Franks had sufficient time to plan the deployment of his OIF command headquarters to the theater. He began assembling a deployable headquarters as early as December 2001 in the waning days of major combat in Afghanistan. By the fall of 2002, the new command center in Qatar was ready for use by CENTCOM. In December 2002, General Franks held a command post exercise, named Internal Look, with the new headquarters. Following that exercise, the CENTCOM headquarters staff from Tampa stayed in place in Qatar and prepared for OIF.⁴

During OIF, despite the lessons of Afghanistan, some key functions were still performed in Tampa. Most notable among these was intelligence analysis. General Franks revamped his Joint Intelligence Center during the summer and fall of 2002. The biggest challenge was setting up the Common Operational Picture (COP) in his Joint Operations Center (JOC) in Qatar. The COP was designed to guide Franks's decision-making during the conflict.⁵ He also chose to keep his main battle damage assessment (BDA) cell located in Tampa, rather than with the forward deployed Combined Air Operations Center (CAOC).⁶

Command and Control

The command relationships between national leaders, the CENTCOM commander, and his subordinate commands in OIF are depicted in Figure 7.1. The Chairman of the Joint Chiefs of Staff (CJCS) had only a coordinating role. The chain of command flowed directly from the President to the Secretary of Defense to the CENTCOM commander. Compared to the command relationships in Operation ALLIED FORCE in Kosovo from May 7 to June 22, 1999, the CENTCOM structure was extremely streamlined and much more effective. ALLIED FORCE was fought as an alliance and not a coalition. Consequently, command and control relationships governing the

³ Interview with Brigadier General (USA) Gary Harrell, SOCCENT commander in OIF, SOCCENT HQ, Tampa, FL, July 10, 2003.

⁴ Jim Garamone, "Transformation on Display in Qatar," American Forces Information Service, December 2002.

⁵ Interview with CENTCOM Media Manager, CENTCOM HQ, Tampa, FL, September 2003. A more detailed discussion of the COP is included below.

⁶ Moseley, "Operation IRAQI FREEDOM—By the Numbers."

Figure 7.1
National and Component Command and Control

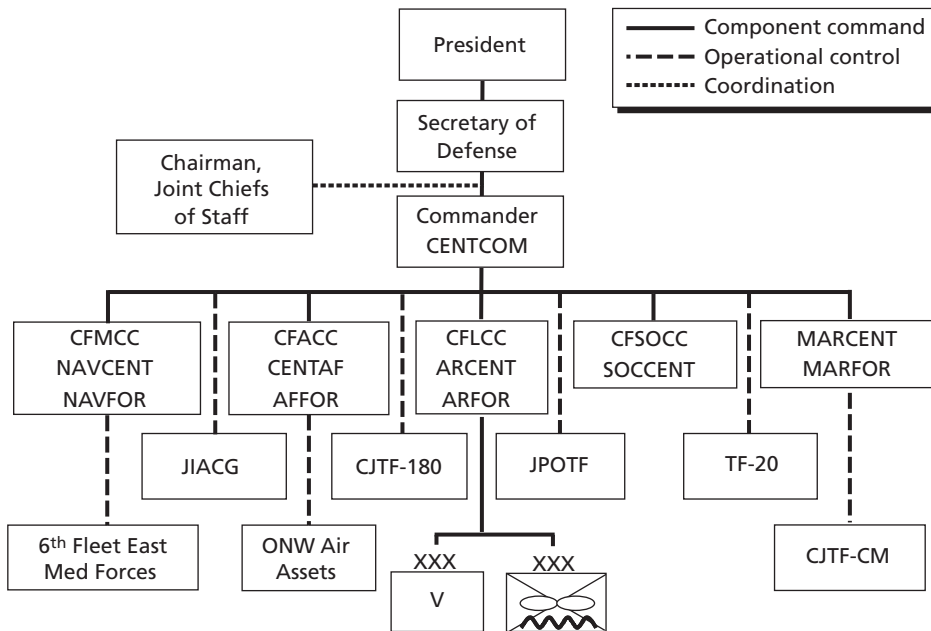

RAND MG641-7.1

NATO alliance applied. This meant that the EUCOM commander, General Wesley Clark, was forced to deal with multiple chains of command.⁷

Because General Franks decided not to create a combined joint task force to fight the war, the combatant commanders assumed a more prominent role in conducting combat operations. In general, the component commanders serve as the force providers for the regional commander, in this case, CENTCOM. In OIF the Combined Forces Land Component Command (CFLCC) assumed operational control role over all land forces, except special operations forces: These were controlled by the Combined Forces Special Operations Component Commander (CFSOCC); the Combined Forces Air Component Commander (CFACC) controlled all air operations in the Iraqi theater of operations through the Combined Air Operations Center (CAOC); and the Combined Forces Maritime Combatant Commander (CFMCC) controlled all naval forces.

The command and operational control relationships in OIF depicted in Figure 7.1 represent the major assignments. The service and functional components are represented by command lines; other subordinate commands are represented by opera-

⁷ For a fuller discussion of command and control relationships in Allied Force, see Bruce Nardulli, Walter Perry, et al., *Disjointed War: Military Operations in Kosovo, 1999*, Santa Monica, CA: RAND Corporation, MR-1406-A, 2002. Chapter Four addresses command and control relationships and procedures.

tional control lines and (in one instance) with coordinating lines. The command and control relationships are explained below and in the text box on page 251.⁸

- **CFLCC.** The commander of the Army's Central Command (ARCENT), also the commander of 3rd U.S. Army, was appointed as both the Combined Forces Land Component Commander (CFLCC) and commander of all Army forces in the area of operations. As such, he had operational control of all ground forces in the area of operations—to include British forces and U.S. Marines, but not including U.S. and coalition special operations forces.⁹
- **CFACC.** The commander of U.S. Central Command Air Forces (CENTAF), also the commander of the 9th U.S. Air Force, was appointed as both the Combined Air Forces Component Commander (CFACC) and the commander of all U.S. and coalition air forces in the area of operations for Air Force forces (AFFOR). As the AFFOR commander, he was given operational control over any U.S. European Command (EUCOM) aircraft participating in NORTHERN WATCH. However, as the CFACC he was granted tactical control over EUCOM air forces.¹⁰
- **CFMCC.** The commander of U.S. Naval Forces Central Command (NAVCENT), also the commander of 5th U.S. Fleet, was designated both the Combined Forces Maritime Component Commander (CFMCC) and the commander of all naval forces in the area of operations (NAVFOR). He was responsible for the conduct of maritime operations in the area and was granted coordinating authority with the USNAVEUR commander, who was also commander of the 6th Fleet, to execute Tomahawk Land Attack Missile (TLAM) tasking for USNAVEUR naval forces operating in the eastern Mediterranean in support of operations in Iraq.¹¹
- **CFSOCC.** The commander of Special Operations Command, Central (SOC-CENT) was designated the Combined Forces Special Operations Component Commander (CFSOCC); he conducted special operations in the area of operations. CFSOCC was also granted command and control of coalition SOF to the degree permitted by individual country requirements and agreements.¹²
- **MARCENT.** The commander of U.S. Marine Forces Pacific (MARFORPAC) was designated commander of U.S. Marine Forces Central Command (MARCENT); he was responsible to the commander of CENTCOM for providing all Marine Corps forces in the area. These forces were placed under the opera-

⁸ These terms are defined in the *Department of Defense Dictionary of Military Terms*, Joint Publication 1-02.

⁹ Patricia Slayden Hollis, "CENTCOM: Targeting in a Unified Command," *Field Artillery*, May–June 2001.

¹⁰ Hollis.

¹¹ Hollis.

¹² Hollis.

Command Relationships

The Department of Defense has established policies regarding the command and control of military units. The intent is to provide a legal framework that governs the type and amount of authority that commanders may exercise. Four types are defined:

- **Combatant command (command authority) (COCOM).** Nontransferable command authority, exercised only by commanders of unified or specified combatant commands unless otherwise directed by the President or the Secretary of Defense. Combatant command (command authority) cannot be delegated and is the authority of a combatant commander to perform functions of command over assigned forces.
- **Operational control (OPCON).** Command authority that may be exercised by commanders at any echelon at or below the level of combatant command. Operational control is inherent in combatant command and may be delegated within the command. It is the authority to perform functions of command over subordinate forces necessary to accomplish the mission.
- **Tactical control (TACON).** Command authority over assigned or attached forces or commands limited to the detailed direction and control of movements or maneuvers within the operational area necessary to accomplish missions assigned. Tactical control is inherent in operational control.
- **Coordinating authority.** A commander assigned responsibility for coordinating specific functions or activities involving forces of two or more military departments, two or more joint force components, or two or more forces of the same service. The commander or individual has the authority to require consultation between the agencies involved, but does not have the authority to compel agreement.

tional control of the CFLCC.¹³ In addition, the Combined Joint Task Force's Consequence Management (CJTF-CM) team fell under the operational control of MARCENT; it was responsible for consequence management operations throughout the CENTCOM area of operations.¹⁴

- **TF-20.** The CENTCOM commander retained operational control of TF-20. TF-20 is referred to as "black SOF" and consists mostly of Army Special Forces units. It conducted special operations in theater.¹⁵
- **JPOTF.** The commander of the 8th Battalion, 4th Psychological Operations (PSYOP) Group (Airborne) was designated the commander of a Joint Psychological Operations Task Force (JPOTF) under the operational control of the CENTCOM commander.¹⁶
- **CJTF-180.** The commander of the Combined Joint Task Force 180 (CJTF-180) continued to function under the operational control of the CENTCOM com-

¹³ Briefing by Lieutenant General Earl B. Hailston (USMC), Commander, MARCENT, April 24, 2003.

¹⁴ For a fuller discussion of the consequence management mission in Iraq, see U.S. Department of Defense, Joint Publication 3-40, *Joint Doctrine for Combating Weapons of Mass Destruction*, Washington, D.C.: GPO, July 8, 2004.

¹⁵ GlobalSecurity.org, "U.S. Forces Order of Battle," June 25, 2003.

¹⁶ Hollis.

mander. CJTF-180 was responsible for the planning and conduct of operations in Afghanistan.¹⁷

- **JIACG.** The Joint Interagency Coordination Group (JIACG) was formed within the CENTCOM staff and worked under the operational control of the CENTCOM commander. JIACG was responsible for coordinating activities between and among U.S. governmental agencies and integrating their actions with CENTCOM operations.¹⁸

Command and Control of Land Forces

The CFLCC was responsible for directing all land forces in the area of operations. It was tasked with coordinating all operations in the Joint Rear Area, defined as Kuwait, Qatar, and a portion of the Saudi Arabian coastline: south to the ports of Jubayl and Ad Dammam, and inland to include the ground lines of communications.

General Franks exercised control of ground forces through daily videoconferences with his component commanders, including the CFLCC, Lieutenant General David McKiernan, to whom Franks delegated considerable authority to run the ground campaign.¹⁹

Command and Control of V Corps Units

Lieutenant General William Wallace commanded V Corps under the operational control of the CFLCC. Its assigned area of operation was generally west of the Euphrates River. During combat operations it was to conduct the main attack and, therefore, was considered the supported force.

The units under the command of V Corps, depicted in Figure 7.2, at the start of hostilities included the 3rd Infantry Division, the 101st Airborne Division (Air Assault), one brigade of the 82nd Airborne Division, and the 11th Attack Helicopter Regiment. As a result of Turkey's refusal to allow U.S. forces to use its ports for staging, the 4th Infantry Division did not join V Corps until April 2003, after major combat operations were over. The 2nd Light Armored Cavalry Regiment also joined the corps later in the campaign. A limited amount of corps artillery was also available. The 214th and 41st Field Artillery Brigades comprised the corps artillery with a total of three Multiple Launch Rocket System (MLRS) battalions. The 130th Engineers provided direct support to the corps.

Due to communication limitations, Lieutenant General Wallace had both forward and rear command posts. He commanded V Corps from his mobile assault command post (ACP)—an ad hoc collection of vehicles and personnel that supported him

¹⁷ GlobalSecurity.org, "Combined Joint Task Force 180," April 2004.

¹⁸ M.E. Bogdanos, "Joint Interagency Cooperation: The First Step," *Joint Forces Quarterly*, Issue 37, Spring 2005.

¹⁹ Interview with Major General James A. Marks, CFLCC J-2 during OIF, Washington, D.C., February 12, 2003.

Figure 7.2
Command and Control of V Corps Units

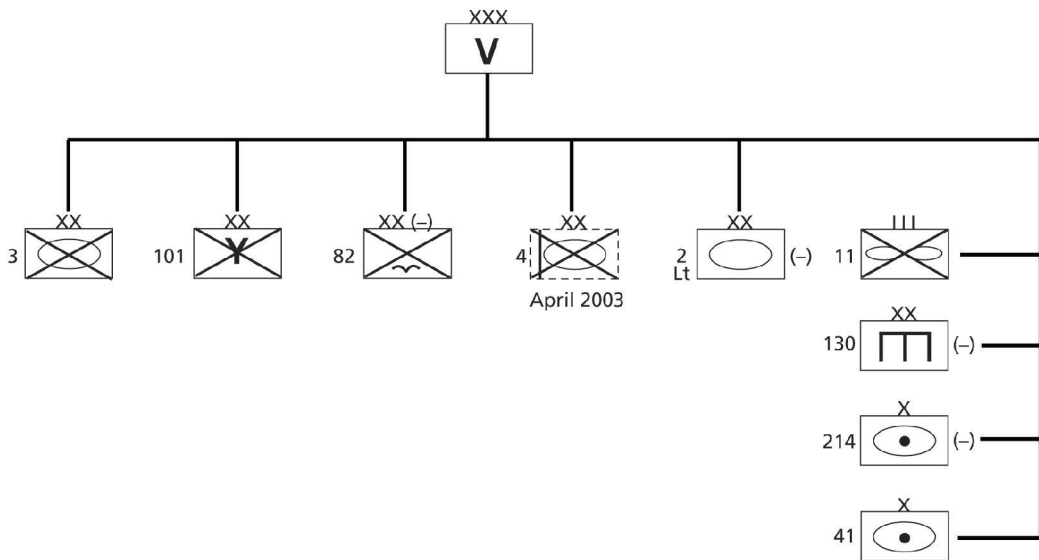

RAND MG641-7.2

in the field. The ACP consisted of 83 people distributed among intelligence, command and operations, and fire support vehicles. It could monitor deep and rear operations as well as the execution of V Corps plans.²⁰

Lieutenant General Wallace left his main command post in the rear at Camp Virginia in Kuwait because communications with the CFLCC (also in Kuwait) were problematic in the field (more on this subject below). He moved it to Baghdad in late April. The main command post did most of the targeting and submitted requests for air support. It also coordinated with the CFLCC.²¹

Command and Control of Marine Corps Units

Marine Corps units were placed under the operational control of the 1st Marine Expeditionary Force (I MEF) as depicted in Figure 7.3. I MEF, commanded by Lieutenant General James T. Conway, had the 1st Marine Division under its command. Conway initially controlled I MEF from his headquarters in Kuwait. Subsequently he deployed forward and controlled his forces from a mobile command post much like Lieutenant General Wallace. Task Force Tarawa, comprised mainly of marines from the 2nd

²⁰ U.S. Army V Corps, "V (US) Corps Assault Command Post: After Action Review and Lessons Learned"; interview with Lieutenant General William S. Wallace, former commanding general of V Corps during OIF, Arlington, Virginia, October 6, 2003.

²¹ Interview with Wallace, 2003.

Figure 7.3
Command and Control of Marine Corps Units

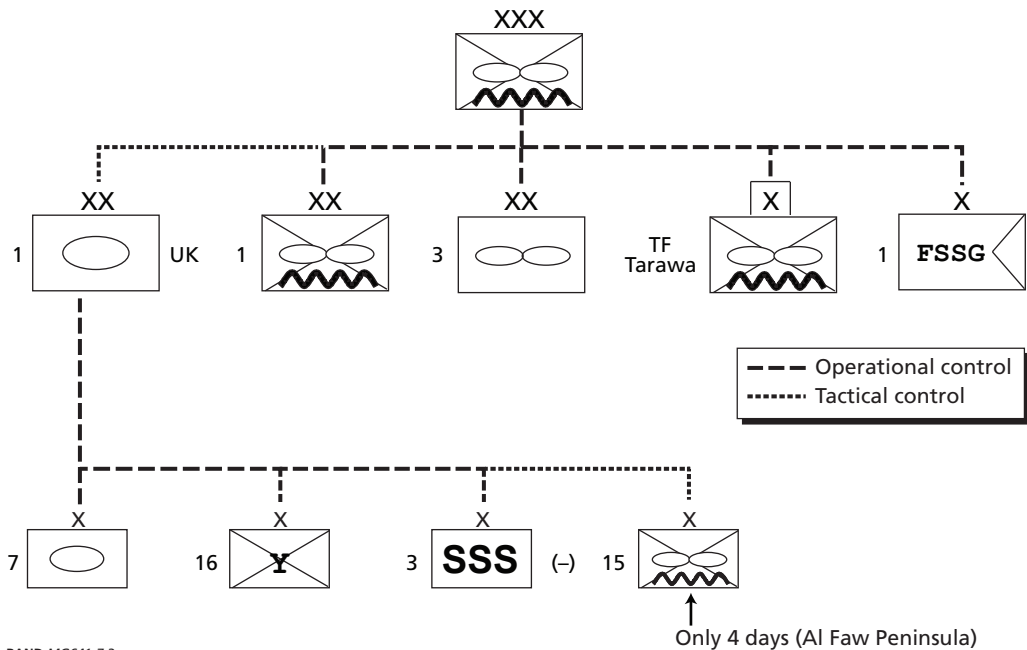

Marine Expeditionary Brigade at Camp Lejeune, was available for supporting tasks, such as clearing the route through An Nasiriyah. Task Force Tarawa remained under the direct control of I MEF, not 1st Marine Division. 3rd Marine Air Wing (MAW) supported all elements of I MEF.

The principal units of I MEF were the 1st Marine Division from Camp Pendleton, California;²² the 3rd Marine Air Wing (MAW), composed of fighter, helicopter and support aircraft air groups; Task Force Tarawa; and the 1st Force Service Support Group, which provided most logistical support for I MEF. Additionally, the UK 1 Armoured Division was TACON to I MEF. The British division initially had TACON of the 15th Marine Expeditionary Unit (MEU). That reinforced, battalion-sized unit remained under the control of the UK 1 Armoured Division until the fifth day of operations, when it reverted to the control of Task Force Tarawa in the An Nasiriyah area. Task Force Tarawa and the 15th MEU deployed with an organic air element, per the Marine Air-Ground Task Force concept, but once they reached the operational area, their air elements were brought under the control of 3rd MAW.

²² The 1st Marine Division was reinforced by some units from 2nd Marine Division at Camp Lejeune, North Carolina; for example, the 2nd Marine Tank Battalion.

The UK's 1 Armoured Division

Air Marshal Burridge, the UK National Contingent Commander located in Qatar, had operational control over the UK's forces in theater, while the UK Chief of Joint Operations had command of those forces. The UK land component commander was under the operational control of I MEF. However, he had “red card” authority to prevent British forces from being involved in unauthorized activities. The UK maritime commander was the deputy CFMCC, as had been established for ENDURING FREEDOM. The relationship between UK and U.S. air component commanders was long established because of SOUTHERN WATCH. The UK air component commander had tactical control of the UK's air assets in theater, and he could allocate these to the U.S. CFACC for specific missions.²³

The division consisted of four major elements: 7 Armoured Brigade, 16 Air Assault Brigade, 3 Commando Brigade, Royal Marines (designated “SSS” in Figure 7.3), and the 15th MEU, U.S. Marine Corps (until the fifth day of operations—after the fight for Basra and the Umm Qasr region was completed).²⁴

Command and Control of Air Forces

The CFACC was located at Prince Sultan Air Base in Saudi Arabia, where he was responsible for directing air operations in the area through the Combined Air Operations Center (CAOC). The CFACC was also designated as the Airspace Control Authority (ACA) and the Area Air Defense Commander, which meant that he was responsible not only for the conduct of all air operations but also for defense of the airspace in the area of operations. Because air operations in the north could potentially involve Turkey, the CFACC was charged with coordinating airspace control with Turkey.

Figure 7.4 depicts the control arrangements in place between the CFACC, the Air Expeditionary Forces (AEF), Coalition Forces, Operation NORTHERN WATCH, and the Army Air and Missile Defense Command (AAMDC).

The air forces assigned to the CFACC consisted of air wings that were originally part of the NORTHERN and SOUTHERN WATCH rotations. Table 7.2 lists the wings for each Air Expeditionary Force (AEF). These were considered part of the third cycle of the AEF rotation that began in March 2002. Each AEF has three wings associated with it: the Lead wing, the Support wing, and the On Call wing:

- **Lead wing.** This wing provides leadership to the AEF. It supplies commanders, if tasked to provide group- or wing-level leadership in a deployed area.

²³ House of Commons Defence Committee, *Lessons of Iraq: Third Report of Session 2003–2004*, Vol. I, London: The Stationery Office Limited, 2004.

²⁴ For a more detailed discussion of 1 Armoured Division operations, see Chapter Five.

Figure 7.4
Air Forces Control Structure

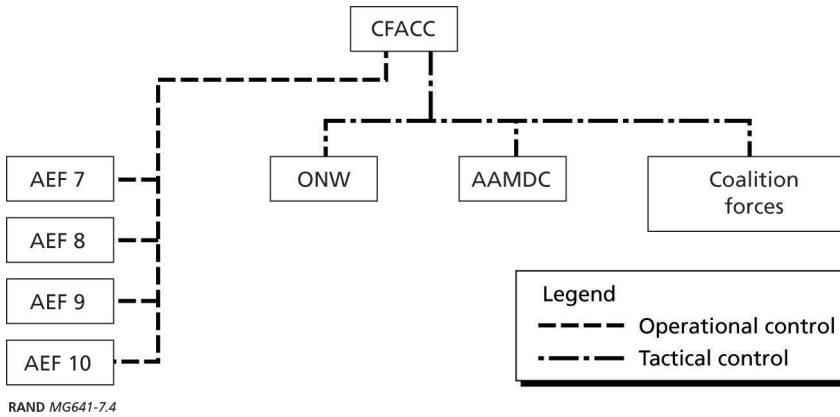

Table 7.2
Air Expeditionary Force Composition for Operation IRAQI FREEDOM

AEF	Operation	Lead Wing	Support Wing	On Call Wing	Date
7	SOUTHERN WATCH	27th Fighter Wing	60th Air Mobility Wing	366th Wing	Dec 1, 2002 Feb 28, 2003
8	NORTHERN WATCH	28th Bomb Wing	60th Air Mobility Wing	366th Wing	Dec 1, 2002 Feb 28, 2003
9	SOUTHERN WATCH	2nd Bomb Wing	305th Air Mobility Wing	366th Wing, 4th Fighter Wing	Mar 1, 2003 May 31, 2003
10	NORTHERN WATCH	1st Fighter Wing	305th Air Mobility Wing	366th Wing, 4th Fighter Wing	Mar 1, 2003 May 31, 2003

- **Support wing.** This wing provides transportation and refueling capability for the AEF.
- **On Call wing.** The On Call wing provides a rapid-response capability for the AEF. It is required to respond within 48 hours to meet unplanned, “pop-up” contingencies.

Controlling Air Operations

The CAOC controlled all air operations. There were two geographically separate CAOCs for OIF, the primary one at Prince Sultan Air Base and an alternate at Al Udeid in Qatar. The CAOC was being transferred from Prince Sultan Air Base to Al Udeid when OIF began. Though the transition was not complete in time for major combat operations, the organizations at the two CAOCs were the same, thus facilitating cooperation.

A theater air control system was created within the CAOC to control the airspace. An integral part of that system was the Air-Ground Operations System (AGOS). Its primary function was to interact with the CFLCC—in particular, with the Air Support Operations Center (ASOC) that supported V Corps and the Direct Air Support Center (DASC) that supported the I MEF.

The DASC was integral to the I MEF, but the V Corps' ASOC consisted of the Air Force's 4th Air Support Operations Group. This group was initially co-located with V Corps' main command post at Camp Virginia in Kuwait. Air requests in the V Corps area of operations were approved by the corps' Air Operations Officer and were controlled by the ASOC. The U.S. Air Force Tactical Air Control Squadrons also supported the 3rd Infantry Division and the 101st Airborne Division. They provided access to the air-ground system at the division command posts and supplied tactical air control parties (TACPs) and terminal attack controllers to control air-ground operations.

All air strikes short of the fire support coordination line (FSCL) in the V Corps area of operations were designated close air support and therefore fell under ASOC control, as were air interdiction, armed reconnaissance, and forward air control (airborne). V Corps preferred to keep the FSCL fairly far forward of the forward line of troops, often about 100 kilometers or more. V Corps also retained authority to open and close killboxes short of the FSCL.

In contrast to the V Corps' ASOC, the Marine Corps DASC was co-located at a lower echelon with the 1st Marine Division and not I MEF. The I MEF used a battle-field coordination line (BCL) 20–30 kilometers beyond the forward line of troops, which was often inside the common FSCL. Like V Corps, I MEF controlled all air attacks inside the BCL and elected to use interdiction or close air support killboxes inside the BCL.

Controlling the Targeting Process

The targeting process in OIF was a refinement of the ENDURING FREEDOM targeting process. Although dependent upon the category of target to be serviced, the process always consisted of selecting targets and matching them with an appropriate response. The response was usually air-delivered, but it was not always kinetic.²⁵ As discussed later in this chapter, information operations (IO) capabilities were often chosen as the appropriate response. In some cases, jamming a radio frequency was deemed more appropriate than destroying the radio transmitter.

Broadly, the targeting process consists of analyzing the nature of the target and matching it with the most effective means of attacking it. In OIF, targets fell into one

²⁵ The term *kinetic* is used in the military to mean physically destructive munitions. It is derived from the term *kinetic energy*, which is the energy imparted by a moving object.

of five categories, depending on how they were developed, their importance, and their time urgency:

- **Deliberate targets.** These are targets nominated by the component commands at least 72 hours in advance of when they are to be attacked. They are usually placed on an air tasking order (ATO) for subsequent execution. The time between nomination and execution is usually referred to as the ATO cycle.
- **Time-sensitive targets (TST).** These are targets that are relatively transient: They must be serviced rapidly or they will disappear. These are targets identified within the ATO cycle of such importance to the CENTCOM commander that they must be struck as soon as possible with any asset.²⁶
- **Close air support (CAS).** Targets in this category are serviced in direct support of ground forces. Attacking aircraft are called in from the requesting units through a tactical air control party (TACP) located with the ground unit. Aircraft are “talked onto” the target by the TACP.
- **Flex or re-role targets.** These targets are nominated within the ATO cycle; that is, they are not as urgent as TSTs, but they cannot wait for the next ATO cycle. They are serviced by redirecting an aircraft from one or more of its assigned targets to the more urgent target.
- **High-value targets (HVTs).** These are targets of special interest, such as the Iraqi leadership. The distinguishing feature of these targets is that appropriate approval must be secured before they can be attacked. Once approval is secured, they may be treated either as re-role targets or TSTs; alternatively, they may be added to the next ATO cycle.²⁷

Before the formal start of hostilities, CENTCOM focused on response options controlled by the CAOC, which the Joint Task Force–Southwest Asia maintained at Prince Sultan Air Base, Saudi Arabia.²⁸ These options were small-scale air attacks in response to Iraq’s movement of threatening air defense systems into the southern no-fly zone. The Secretary of Defense exercised close oversight over these responses. Imagery analysts from the Defense Intelligence Agency and the National Imagery and Mapping Agency’s Middle East Division supported the options. Well into ENDURING FREEDOM, a small cell of CENTCOM target planners known as the Iraqi Cell was dedicated to developing contemporaneous plans to attack these anti-aircraft artillery, surface-to-air missile, and radar targets in Iraq. The CENTCOM deputy commander

²⁶ U.S. CENTAF, “Time Sensitive Targeting: Operation Iraqi Freedom,” briefing, May 2003.

²⁷ Between ENDURING FREEDOM and IRAQI FREEDOM, procedures were established to gain preapproval for these targets. The HVT cell at CENTCOM compiled dossiers on all known HVTs and attempted to gain preapproval for each.

²⁸ Interview with Major General (USAF) David Deptula, October 2001.

Lieutenant General (USMC) Michael DeLong obtained approval from the Office of the Secretary of Defense to execute these plans as response options. By the spring of 2002, General Franks decided to accelerate this effort to begin preparing for an operation against Iraq.

The High Collateral Damage Assessment briefings were the main communications medium used by General Franks to vet targeting ideas in the planning stages with the Secretary of Defense. During major combat operations General Franks continued to forward Sensitive Target Assessment Reports.²⁹ He met with key staff officers in his Doha headquarters early each morning to review the situation in preparation for a secure telephone call with the Secretary of Defense later in the morning. Brigadier General (USA) Jeffrey Kimmons, the CENTCOM J-2, normally briefed General Franks on the current intelligence assessment.³⁰ The meeting usually generated tasks for the Joint Intelligence Center in Tampa, the High-Value Target Cell, and the CENTCOM Targeting Division's cells in Qatar.

Coordinating with the CIA

In his book *Plan of Attack*, Bob Woodward claims that the CIA engaged in more than training and assistance in Iraq: that the President authorized the CIA to engage in direct action. Specifically, he lists the following among the several authorities granted to CIA operatives on February 16, 2003:

- Conduct sabotage operations inside Iraq.
- Work with third countries—such as Jordan and Saudi Arabia—and support their covert intelligence operations.
- Attack and disrupt regime revenues, banking, and finances.
- Disrupt the regime's illicit procurement of materiel related to its military, especially its weapons of mass destruction program.³¹

Although this has not been verified from official sources, it appears credible given the CIA's operations in Afghanistan.

An important issue in all of this is the relationship between the CIA operatives in the field engaging in direct action and either special operations forces or conventional forces operating in the same area. Coordination with the military forces was accomplished only at the CENTCOM level through the CIA's Special Activities Division (SAD) located at CENTCOM headquarters.

²⁹ Interview with Katherine Alexander, JCS/J-2, 2003. Ms. Alexander was in charge of the No-Strike List for OIF. She also was responsible for creating the packages on targets that required approval from the Secretary of Defense.

³⁰ These sessions were referred to by many staffers at CENTCOM as the "SECDEF Prep" block on the schedule.

³¹ Woodward, pp. 108, 109.

Communicating with the Force

The rapid pace of ground operations posed a challenge to commanders as they tried to control their dispersed forces. Traditional terrestrial systems that employ HF and VHF communications frequency bands have limited range and usually require line-of-sight connectivity. In the heavily urbanized areas of Iraq, this became impossible. Tactical satellite communications offered a solution, but very few were available in theater with sufficient bandwidth. The Blue Force Tracker (BFT) component of the Force XXI Battle Command Brigade and Below (FBCB2) was also available; it provided a means to track friendly forces and to communicate with them via a rudimentary email system.³²

Blue Force Tracker

More than 1,300 FBCB2-BFTs were deployed with coalition forces in Iraq.³³ The BFT was considered a success story: The ability to track friendly forces in a cluttered tactical environment, although not perfect, proved invaluable. The satellite-based version of BFT allowed commanders to communicate with forward-deployed forces via email—not the best medium, but more effective than short-range terrestrial systems. Although his division received only 150 units, Major General Blount, 3rd Infantry Division commander, said without BFT he couldn't imagine how he would have been able to monitor the more than 10,000 vehicles under his control that crossed the line of departure.³⁴ Figure 7.5 illustrates the configuration of the BFT in the Bradley fighting vehicle and the Abrams tank. The standalone unit was used in vehicles without built-in units. Hence the term “appliqué.”

Blue Force Tracker was also used for navigation when visibility was poor. Its ability to place friendly forces on a high-resolution, digitized map allowed the unit commander to direct his forces through built-up areas at night. Lieutenant Colonel John Charlton, commander of the 1st Battalion of the 15th Infantry, while touting the value of BFT, described the version he had as “a dumbed-down version of the full FBCB2 suite.”³⁵ Its greatest utility, according to Charlton, was its ability to help him navigate his unit through built-up areas at night and during the sandstorm.

³² The FBCB2 system was an integral part of the Army's digitization program, but only the Blue Force Tracker capability was provided to units participating in OIF.

³³ Giles Ebbutt, “Blue Force Tracking by Northrop Grumman,” *Jane's International Defence Review*, December 1, 2003.

³⁴ Interview with Major General (USA) Buford C. Blount, Commanding General 3rd Infantry Division, November 18, 2003. Blount had been Chief of Staff at 4th Infantry Division when FBCB2 made its Army debut, so he had a good understanding of its capabilities.

³⁵ Lieutenant Colonel John W. Charlton, “Digital Battle Command: Baptism by Fire,” 1-15 IN/3 Infantry Division, July 31, 2003.

Figure 7.5
Blue Force Tracker Configurations in Operation IRAQI FREEDOM



Standalone unit used
 as an “appliqué”

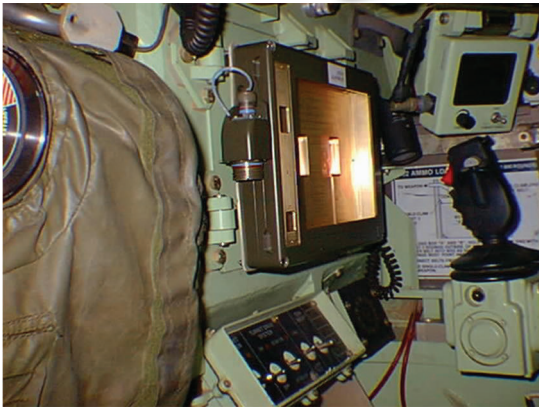

Configuration in a Bradley Fighting Vehicle

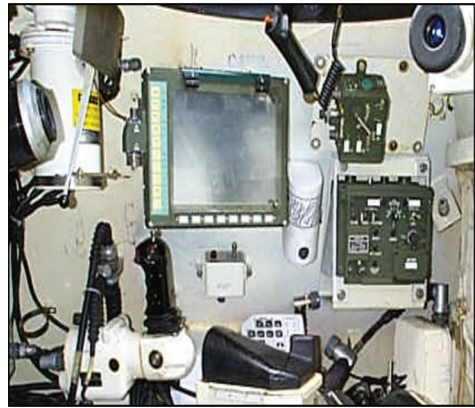

Configuration in an Abrams tank

SOURCE: Force XXI briefing, undated.

RAND MG641-7.5

Tactical Satellite and Terrestrial Systems

Both Lieutenant General Wallace, then commander of V Corps, and Major General Blount, then commander of the 3rd Infantry Division, praised tactical satellite communications as a key enabler during OIF. Older line-of-sight terrestrial communications generally did not work effectively. Tactical satellite communications enabled the 3rd Infantry Division commander to develop and share a common picture of the battlespace covering a distance of more than 200 kilometers. It also gave him the ability to direct subordinate commanders at tense moments, such as during the first “Thunder Run” into Baghdad.³⁶

For tactical units below division, the communications backbone consisted of terrestrial systems. For the 3rd Infantry Division, that backbone was the Mobile Subscriber Equipment (MSE) system. Unfortunately, it was incapable of supporting communications while on the move. MSE was designed in an earlier era during which traditional linear battlefields were contemplated. In that era, complex fixed communi-

³⁶ See Chapter Four for a discussion of the the two “Thunder Runs” and other important OIF battles.

cations facilities complete with subscriber equipment and fixed relay sites were feasible and even desirable. In a nonlinear battle, fixed facilities are impractical. Much of the battlefield is not secure, thereby precluding the installation of isolated relay facilities. The fast pace of nonlinear operations also precludes setting up anything like a permanent subscriber facility.

Situational Awareness

Within the military during OIF, situational awareness was taken to mean knowledge of both the friendly and the enemy situation. It comprised the information a ground commander and his forces needed to prosecute their campaign, and it included actionable intelligence, an important ingredient of ground combat. At the end of major combat operations in Iraq, headlines were filled with claims of “unprecedented situational awareness.” Allegedly, new sensor technologies painted a clearer picture of the battlefield than commanders had ever experienced. Secretary of Defense Rumsfeld and the CENTCOM commander, General Franks, echoed these claims when they reported to Congress on the results of the war.³⁷ On the other end, tactical commanders on the move complained that they discovered the enemy “by running into them, much as forces have done since the beginning of warfare.”³⁸ They relied on movement-to-contact and armed reconnaissance to gain an understanding of the enemy facing them, just as their predecessors did in World War II and earlier.

Although these two views appear to contradict each other, the truth is that they do not: the view that commanders and staff had of the enemy depended on which side of the “digital divide” they happened to be on: automatic distribution of digitized intelligence information worked relatively well at echelons above brigade, but it was much less timely at brigade and below, where units could not receive the information while on the move. Those who made claims of unprecedented situational awareness referred to the view commanders at fixed locations (usually component commanders and above) experienced based, in part, on what was in truth “unprecedented sensor coverage.” Those who complained that finding the enemy meant drawing his fire were simply stating that intelligence derived from those sensors rarely, if ever, got to them in time to make a difference. In OIF, sensor coverage of the battlespace was indeed unprecedented. However, sensor coverage alone does not necessarily translate into situational awareness; processing and dissemination are needed as well. We examined the

³⁷ U.S. Senate, *Summary of Lessons Learned, Prepared Testimony by SECDEF Donald H. Rumsfeld and General Tommy R. Franks: Hearing before the Senate Armed Services Committee*, Washington, D.C.: GPO, July 9, 2003.

³⁸ “The byzantine collections process inhibited our ability to get timely responses to combat requirements, with the exception of assets organic to or [in direct support] to the Division. This made the Division almost exclusively reliant on organic . . . collection assets. The Division found the enemy by running into them, much as forces have done since the beginning of warfare.” 1st Marine Division, *After Action Report*.

degree to which commanders at all levels were aware of the situation confronting them when taking major decisions. This required us to examine the means of collecting information (surveillance and reconnaissance), the processing of that information to produce intelligence, and the efficiency and effectiveness of means to disseminate the resulting intelligence.

Collection

Gaining situational awareness begins with collecting information. The problem is where to look, what assets to use, and which commanders to support. Collection, therefore, is a resource allocation problem whose solution is a collection management plan. The major combat phases of OIF featured 80 dedicated surveillance and reconnaissance platforms used by coalition forces to fly 1,000 sorties, generating 42,000 battlefield images, 3,200 hours of full-motion video, 2,400 hours of signals intelligence (SIGINT) coverage, and 1,700 hours of Moving-Target Indicator (MTI) radar imagery.³⁹ Nevertheless, battlefield commanders reported significant gaps in their understanding of the disposition and capability of enemy forces arrayed before them.

The collection assets available in OIF consisted of national sensors and air assets, to include fixed-wing aircraft, unmanned aerial vehicles (UAVs), and tactical aircraft.

- **National assets.** During OIF, the top priority for all national assets, including overhead SIGINT and imagery satellites as well as tactical and national HUMINT, was to support combat operations. During major combat operations, General Franks managed these assets, which consisted mainly of satellites controlled by the National Reconnaissance Office.
- **UAVs.** Several UAVs were available in the area of operations. These consisted of Air Force, Army, and UK assets. The most productive UAVs in terms of hours of video produced were the Air Force's Predator and Global Hawk and the Army's Hunter.
- **Fixed-wing aircraft.** Fixed-wing surveillance consisted of aircraft traditionally configured as sensor platforms, such as JSTARS, the U-2, the P-3 Orion, the British Canberra and Nimrod, plus what the command referred to as nontraditional platforms. These included A-10s and F-16s equipped with LITENING II pods.

The Role of UAVs

More than a dozen varieties of UAVs were used for surveillance (Table 7.3). They included CFACC-controlled RQ-4 Global Hawks and RQ-1 Predators; CFLCC-controlled Hunter, Pointer, and Shadow; and Marine Corps-operated Pioneer and

³⁹ Moseley, "Operation IRAQI FREEDOM—By the Numbers."

Table 7.3.
Comparing UAVs Used in Operation IRAQI FREEDOM

Platform	Payload	Maximum Airspeed (MPH)	Maximum Altitude (ft AGL)	Range (miles)	Endurance (hours)	Command Level Supported	Major Use
Global Hawk	EO, IR, SAR	220	25,000	13,750	35	CFACC (CAOC)	Primarily to support attacks against TSTs
Predator	EO, IR, SAR	630	65,000	14,000	24	CFACC (CAOC)	RSTA, killer scout, CAS/ground force protection, lightly armed reconnaissance
Desert Hawk	Video	55	500	—	1	Air base security forces	Detection of insurgents poised to interfere with air operations at air bases
Hunter	FLIR, MOSP, Laser designator, Relay, Jammers, Radar	200	15,000	120 ^a	12	V Corps	Detection of ground forces, armed reconnaissance using the Viper Strike system, ^b electronic warfare
I-GNAT	SAR, EO, IR, Satellite wideband data link	—	25,000	150	50	Combined Joint Task Force	Extended range multi-purpose surveillance and reconnaissance
Shadow	EO and IR camera	130	10,000 ^c	30	72	Brigade	Day/night reconnaissance, surveillance, target acquisition and battle damage assessment
Raven	Video, IR, Chemical agent detection	55	2,000	9	1.3	Battalion	Reconnaissance in support of small unit operations, chemical agent detection.
Pointer	Video, IR	50	2,000	5	1.5	Special Forces	Reconnaissance support to special forces operations in complex terrain.
Pioneer	IR	92	15,000	110	5.5	Marine regiment/ battalion	Reconnaissance in support of small unit operations.
Dragon Eye	Video, IR	35	1,500	6	0.75	Marine battalion	"Over-the-hill or building," force protection, tactical reconnaissance and surveillance
Silver Fox	IR, EO, Chemical agent detector	60	1,000	145	5	Marine regiment/ battalion	Small unit reconnaissance and surveillance, chemical agent detection.

^a This assumes one of the Hunter platforms is utilized as a relay. Without a relay, the range is 75 miles.

^b Viper Strike is a derivative of the Northrup Grumman Brilliant Anti-Tank (BAT) submunition. In August 2003, Hunter successfully destroyed an enemy BMP combat vehicle and incapacitated a moving T-72 tank.

^c This figure is for daytime operations. Maximum altitude at night is 8,000 feet.

ACRONYMS: AGL is above ground level. IR is infrared. EO is electro-optical. SAR is Synthetic Aperture Radar. FLIR is forward-looking infrared. MOSP is Multi-Mission Optronic Stabilized Payload. The MOSP includes television and FLIR to provide day/night surveillance capability. RSTA is reconnaissance, surveillance, and target acquisition.

Dragon Eye UAVs.⁴⁰ There are also reports that a derivative of the Lockheed-Martin–developed “Dark Star” stealthy UAV was used during OIF.⁴¹ With the exception of UAVs controlled by the units themselves, support from this wide array of assets to commanders below corps was minimal. Of all the UAVs available during major combat operations and in the immediate aftermath, three were considered vital: Global Hawk, Predator and Hunter. (See Figure 7.6.)

Global Hawk (RQ-4A). During OIF, the Global Hawk RQ-4A flew only 4 percent of the reconnaissance missions, but it was credited with locating 55 percent of the time-sensitive targets due to its long loiter time and powerful suite of sensors.⁴² It has a range of 12,500 nautical miles and can stay aloft for as long as 35 hours at an altitude of between 55,000 and 65,000 feet—considerably higher than the Predator’s 10,000 to 25,000 feet. It has three sensing capabilities: electro-optical (EO), infrared (IR), and synthetic aperture radar (SAR). CENTCOM requested a total of three Global Hawks, but only one at Al Dhafra, UAE, was allocated. However, it was able to provide a considerable amount of reconnaissance and surveillance data. For example, it flew several missions over Baghdad, once the air defense threat was removed, collecting some 3,700 images.⁴³

Global Hawk was operated remotely from CONUS (continental United States), where all of the exploitation of its imagery also occurred. The Mission Control Elements were located at Beale Air Force Base, California, and at Ramstein Air Base in Germany. Exploitation took place at Langley Air Force Base, Virginia. Global Hawk was apparently most useful in assisting with TSTs and provided targeteers with real-time targeting data to facilitate striking them. Global Hawk provided approximately 55 percent of all TST data.⁴⁴

Figure 7.6
Principal UAVs Used in Operation IRAQI FREEDOM



RAND MG641-7.6

⁴⁰ Marc Selinger, “U.S. Says More Than 10 Types of UAVs in Iraq War, Official Says,” *Aerospace Daily*, March 27, 2003.

⁴¹ David A. Fulgham, “Stealth UAV Goes to War,” *Aviation Week & Space Technology*, July 7, 2003.

⁴² “Too Many Drones?” *Defense Technology*, December 23, 2003.

⁴³ Gail Kaufman, “U.S. UAVs Prove Their Mettle in Iraq,” *Defense News.com*, May 21, 2003.

⁴⁴ “Officials: UAV Lessons Among the Most Vital Gleaned in Iraq War,” *Inside the Pentagon*, July 17, 2003, p.1.

Predator. Of all the UAVs in OIF, the Predator was most widely used (and perhaps the most widely reported in the press). At one point in the operation, three Predator RQ-1s and four MQ-1s were deployed to H-5 airfield (Prince Hassan) in Jordan and four RQ-1Bs and 3 MQ-1s were deployed to Ali Al Salem Air Base in Kuwait.⁴⁵ These were in addition to the four RQ-1's located at Jacobabad to support ENDURING FREEDOM. Predator's focus was primarily strategic; i.e., it was focused on collecting information on the location of WMD sites, the location of SCUD-like missiles in western Iraq, and the hunt for high-value enemy personnel. Very little intelligence from Predator reports was disseminated to tactical commanders.

The Predators were used throughout Iraq to collect imagery on a wide range of targets. In all, approximately 2,300 Predator missions were planned between March 19 and April 10 in the following five classes of targets:

- **Air defense.** Anti-aircraft artillery activity and air defense equipment, to include radar facilities.
- **Iraqi forces.** Area searches for equipment and evidence of enemy emplacements, monitoring units that had been previously located, and a host of other related indicators of the presence of Iraqi forces such as evidence that a unit is preparing to depart, that defensive barriers are being constructed, that convoys are moving in the area, and that troops and vehicles are concentrating or dispersing.
- **Surface-to-surface missiles.** SSM-related equipment and specific SSMs such as the FROG-7, the Ababil 100, the CSSC-3, Al Samoud, and Astro II missiles.
- **Theater ballistic missiles.** TBM, TBM-related equipment, launcher hides, transporter erector launchers, and mobile erector launchers along with their support vehicles.
- **Capitulation.** From the outset, there was a belief among planners that the Iraqis had no stomach for a fight with the United States and its allies. This belief stemmed from information that the Iraqi military was weak, poorly trained, and unwilling to fight for an oppressive regime (see Chapter Six). Consequently, psychological operations focused on instructing Iraqi soldiers on how to capitulate. These instructions were fairly explicit. For example, ground units were told to configure their vehicles in a certain way with a white flag signifying surrender prominently displayed. The CFACC then planned Predator missions to search for signs of compliance. Fully 600 such missions were planned. Unfortunately, there is only one report of a unit partially complying with these instructions. Most Iraqi soldiers self-demobilized, abandoning their equipment.

Hunter. The Hunter RQ-5A is a division- and corps-level reconnaissance, surveillance, target acquisition, and damage assessment platform. It is a short-range tac-

⁴⁵ The RQ-1B is the unarmed Predator with a turbo-charged engine, and the MQ-1 is the same Predator with the addition of armed reconnaissance capability.

tical UAV with electro-optical and infrared sensors. It has a range of approximately 200 kilometers and flies at an altitude of 15,000 feet. It can stay aloft between 8 and 12 hours. In OIF, the Hunter employed was controlled by the CFLCC in support of V Corps.

The intent was for the Hunter to operate as far forward as possible, to concentrate on what was ahead for the fighting elements (primarily the 3rd Infantry Division) and on overall situational awareness, especially with respect to units that V Corps thought the 3rd Infantry Division would be encountering (e.g., the 11th Iraqi Armored Division and the Medina Republican Guard Division).⁴⁶

Fixed-Wing Reconnaissance

Several fixed-wing aircraft were used as collection platforms. Some were traditional reconnaissance assets such as JSTARS, the U-2, and the P-3 Orion, whereas others were not. Nontraditional platforms included F-16s and the A-10, both with a LITENING II pod. Both Marine Corps and Army units claimed to have gained considerable information from fixed-wing aircraft flying close air support missions. These aircraft often passed useful information on enemy emplacements to ground units they were supporting.

Both the Marine Corps and SOF benefited from direct video downlinks from the Aircraft Improvement Program version of the Navy's P-3C aircraft. The P-3s, operating above 15,000 feet in day or night conditions, provided visible overflight and situational awareness to support I MEF's dash north to Baghdad.⁴⁷ It proved to be a powerful platform for surveillance of engaged enemy forces, route reconnaissance, and the disposition of enemy forces soon to be engaged.⁴⁸

The JSTARS is a theater battle management platform with a joint mission crew. It is structured and designed primarily to provide mobile wide area surveillance and targeting of enemy ground forces. It performs battle management functions that include surveillance, command and control, intelligence support, attack support, and support to other operations. JSTARS can detect and track moving and stationary targets. It has a limited capability to discriminate between wheeled and tracked vehicles and military and civilian vehicles.⁴⁹

The Common Ground Station (CGS) served as the ground station for JSTARS and other reconnaissance and surveillance systems. The CGS received and displayed sensor data either directly from the JSTARS Surveillance and Control Data Link or

⁴⁶ Interview with Lieutenant Colonel John Mowers, Assistant G-2, 3rd Infantry Division, Fort Stewart, GA, October 27, 2003.

⁴⁷ David Reade, "Venerable P-3 Aircraft Increases Awareness on the Battlefield," *Sea Power Magazine*, June 11, 2003.

⁴⁸ 1st Marine Division, *After Action Report*.

⁴⁹ U.S. CENTCOM, "JSTARS Concept of Operations," April 2001.

via UHF SATCOM rebroadcast from another CGS. At each site, an Army intelligence specialist operated the CGS and interpreted data for the supported commander. These feeds were limited to CGS facilities that were not moving. Like communications in general, sensor data were limited to units at fixed sites.

The Marine Corps reported that the JSTARS CGS made a significant contribution toward an integrated operational picture. The 1st Marine Division's After Action Report stated that:

No other collection asset provided the wide area all weather coverage of the battle space as the JSTARS did with the MTI [Moving Target Indicator] radar. Critical to our ability to use the capabilities of the JSTARS was the interface provided by the JSTARS Common Ground Station. The equipment allowed us to interact in real time with the collection platform and focus on our critical requirements and process the collection data into useable and actionable intelligence products.⁵⁰

In addition to the 1st Marine Division, JSTARS filled critical requirements for V Corps, the 3rd Infantry Division, and component commanders by monitoring the potential movements of enemy units. JSTARS was particularly valuable to Army commanders during the sandstorms that raged in late March, although there are unconfirmed reports that JSTARS misreported several hundred vehicles moving to the Karbala Gap in what turned out to be a false alarm.

Organic Collection Capabilities

A large portion of the intelligence on the enemy needed for close combat was generated through what Army and Marine Corps commanders reported as movement to contact with the enemy.⁵¹ Major General Blount, commanding the 3rd Infantry Division, indicated that most of his enemy situational awareness came from ground intelligence or his own organic surveillance and reconnaissance assets. The 1st Marine Division's After Action Report was even more to the point:

Tactical units did not have access to collection assets such as UAVs. Their primary means of gaining intelligence with organic resources was through movement to contact and armed reconnaissance. Scout units were able to conduct armed reconnaissance, but many lacked adequately protected vehicles to venture very far. Many commanders therefore, used attack helicopters and close air support aircraft to gain information forward of their position. In most cases, communications with ground commanders from these platforms was voice only.

⁵⁰ 1st Marine Division, "Operation Iraqi Freedom (OIF) Lessons Learned."

⁵¹ Interview with 1 Marine Division personnel, Camp Pendleton, California, October 1–3, 2003.

Sensor Integration

Given the seemingly endless catalog of sensor systems, fusion and analysis facilities, control elements, intelligence organizations, dissemination systems, and competing operational concepts, it is important to examine what, if any, linkages existed among them. Such linkages comprise sensor integration and are critical to the effective functioning of the combined force. It is hard to imagine how the plethora of equipment, facilities, and procedures employed in OIF could not have resulted in at least some duplication and contradiction. All services, including special operations forces, made some attempt to develop systems that linked their various platforms, facilities, and personnel with those of other services into a single overarching integrated network—with varying levels of success. However, when called upon to support key missions such as searching for improvised explosive devices (IEDs), foreign fighters, etc., appropriate interservice sensor integration did not exist.

One of the key communications mediums inherited from ENDURING FREEDOM was the use of chat rooms. Chat rooms were ubiquitous in OIF; they were used by all services as well as special operations forces. The Navy was no longer isolated at sea: Sailors were now able to use chat rooms and secure phones as their primary means of communications with air planners at the CAOC. Though their simplicity helped overcome the “fog of war” in some situations, “chat” quickly became overused. For example, one chat room in the CAOC had 900 people participating at once.⁵² Chat rooms have built-in limitations: an inability to handle large amounts of information and the absence of automation tools that can turn information into actionable intelligence. Additionally, although private communications during chats play a useful role by not clogging up the main conversation, such “whispering” was often used to broker important deals that cut other decisionmakers out of the loop.

Prior to OIF, the Air Force had been looking for a way to network its vast array of sensors that improved support for warfighters. The result was the Distributed Common Ground System (DCGS) architecture. DCGS is an interconnected, worldwide architecture that uses both satellite and terrestrial communications to downlink intelligence data collected by airborne sensors, such as those carried aloft by Predator, Global Hawk, and the U-2 to mobile stretch unit vans, or MOBSTRs, and Deployable Ground Stations. The benefits were an increased flow of information coming into the CAOC’s Combat Operations Division and the elimination of the requirement for a large number of technicians in theater.

Unlike the Air Force, the Army was forced to manage its intelligence processes from highly vulnerable tactical operations centers, which moved into combat zones along with brigade-sized units. These centers, though mobile, had distinct disadvantages. They were large enough to be vulnerable to detection by imagery and, hence, to Iraqi surface-to-surface and cruise missiles. All control of surveillance and reconnais-

⁵² Dan Caterinicchia, “DOD Chat Use Exploded in Iraq,” *Federal Computer Week*, June 23, 2003.

sance remained forward with the tactical units. Communications with CFLCC and other operational elements was accomplished via terrestrial communications. Although the CFLCC had a Predator feed, the dissemination of intelligence gained from Predator images had to be relayed by voice messages to forward-based brigade intelligence (S-2) personnel.

Compounding the CFLCC intelligence problem was the All Source Analysis System (ASAS), which was only marginally effective. The ASAS was designed to automate the processing and analysis of intelligence data from all sources. It is a tactical system consisting of several components: six all-source workstations, six single-source workstations, a single-source processor for SIGINT, a remote workstation to support collateral intelligence processing below the division, and a collateral workstation to support the division's intelligence (G-2) staff.⁵³ The problem in OIF centered primarily on the inability to transmit timely ASAS data. The same problem that plagued dissemination of the common operational picture at higher levels, available bandwidth, also affected the ASAS.

I MEF was controlled by CFLCC. However, it operated with a much different intelligence structure than the Army. During early planning, when it was thought that the 3rd Infantry Division and the 1st Marine Division would be centrally controlled, considerable effort was made to make the Army's ASAS compatible with Marine systems. Workarounds were developed, but the incompatibility of the two systems could not be overcome.

Intelligence

Surveillance and reconnaissance activities have the single purpose of developing actionable intelligence, namely, intelligence that is timely, relevant, accurate, and complete. Reports from OIF are mixed on how well the intelligence community was able to provide actionable intelligence. On the one hand, sensor coverage of the battlespace in OIF can be described as "unprecedented," even though this rarely translated into actionable intelligence at the tactical level. On the other hand, commanders above the division level at fixed facilities thought they had an adequate view of the battlespace. As mentioned at the outset, such differences gave rise to a "digital divide" in OIF.

Intelligence Preparation of the Battlefield (IPB)

Intelligence preparation of the battlefield was the process military forces employed to prepare themselves for combat operations in OIF. It was intended to help commanders understand all of the factors that could affect the conduct of operations—from terrain

⁵³ GlobalSecurity.org. "All Source Analysis System [ASAS]."

and topography, to weather, to the enemy's order of battle, to cultural and political intelligence.

The U.S. military and the intelligence community had been studying the Iraqi military and security services for decades. After the conclusion of the Gulf War in 1991, that close scrutiny continued, both because of Iraq's ongoing obligations to dismantle its weapons of mass destruction and long-range missiles under UNSCR 687, and because the regional threat posed by Iraq, while greatly diminished, had not been eliminated and therefore Iraq remained a threat to U.S. vital interests.

Throughout the 1990s, United Nations Special Commission (UNSCOM) inspectors in Iraq, many of whom were U.S. and allied government personnel, were the source of considerable intelligence on Iraqi WMD and military-related facilities and capabilities.⁵⁴ In addition, frequent U.S. flights over Iraq with U-2 aircraft, under the UNSCR mandate, and other strike and reconnaissance aircraft flying over the northern and southern Iraq no-fly zones provided additional intelligence.

Before the onset of OIF, the United States had very good intelligence on Iraq's order of battle, the disposition and strength of its main Republican Guard and regular army divisions, the capabilities and critical nodes in its air defense network, and the details of its military communications system. The United States, through organizations like the National Imagery and Mapping Agency (now the National Geospatial Intelligence Agency (NGA)) and the Defense Intelligence Agency (DIA), also had a well-developed understanding of Iraq's topography, hydrology, and key terrain features. Knowing that Saddam might withdraw many of his forces into a last-ditch fight for Baghdad, the intelligence community had spent considerable time and effort mapping out and coding by number all of the buildings in Baghdad.⁵⁵ Nevertheless, they had trouble tracking enemy forces once major combat operations were under way.

The intelligence analysts at CFLCC expected that Iraq would pursue a positional defense in depth and that the regular army, prone to desertion and early capitulation, was likely to be ineffective. They believed that the Republican Guard would fight in an outer cordon around, but not within, Baghdad itself. The Special Security Organization and Special Republican Guard would conduct the urban fights within Baghdad and Tikrit. The Ba'ath Party militia and Saddam Fedayeen were considered a factor in urban areas but nowhere else.

As good as the IPB effort was at preparing commanders for the enemy they were to face, other aspects of the effort did not work as well, and effects continued to be felt in subsequent operations in Iraq.

⁵⁴ UNSCOM was created in April 1991 to help the International Atomic Energy Agency (IAEA) enforce UNSCR 687.

⁵⁵ This is referred to as *mensurating* targets—that is, identifying them with specific grid coordinates.

- **The Fedayeen.** While the intelligence community knew of the Fedayeen before the war, including their numbers, the community failed to appreciate the central role Fedayeen would play in Iraq's plan to inflict U.S. and coalition casualties, disrupt lines of communication, and compel reluctant Iraqi military forces and commanders to fight.
- **The Iraqi people.** Most U.S. commanders now acknowledge that there was insufficient appreciation in prewar estimates of the impact that several decades of Saddam's repressive rule had had on Iraq's civilian population. Instead of being greeted as liberators in southern Shi'ite towns such as An Nasiriyah, As Samawah, and An Najaf, coalition forces were instead met with skepticism and, in some cases, hostility.
- **Long-range surface to surface missiles (SSMs).** Although the CENTCOM commander rightly termed SSMs a "strategic dislocator" for their potential to wreak havoc in Israel, few were fired from the west and none landed in Israel. Nevertheless, many of the command's collection assets were allocated there. The opportunity cost of focusing on SSMs was considerable. In addition, there is some evidence to suggest that coalition forces fell victim to an Iraqi deception campaign to make them think that the threat posed by SSMs was much greater than it really was.

The early assessment of enemy forces in and around Baghdad was greatly underestimated. Coalition air and ground efforts had a greater effect on those forces than reported. Moreover, evidence suggests that updates to the initial assessment during major combat operations were too infrequent and often too late to support battlefield commanders. Considering the weight of effort focused on enemy forces defending Baghdad across the entire intelligence community, there was an amazing lack of clarity of intelligence analysis as Army and Marine Corps ground forces approached the city in April. Lieutenant General Wallace reports that when he turned to his corps intelligence officer and asked for his assessment of Baghdad's defenses, the G-2 replied, "Not sure sir, . . . looks like a bunch of bad guys."⁵⁶ Consigned to an unclear and perhaps nonexistent official assessment, Major General Blount used his own intuition and that of his brigade commanders to overlook more pessimistic views of Baghdad's internal defenses and initiate the first Thunder Runs into Baghdad.⁵⁷ Major General Marks reported that visiting CIA Director, George Tenet, told him: "We don't really know any more than you do [about Baghdad's internal defenses]."⁵⁸

⁵⁶ Interview with Wallace, 2003.

⁵⁷ Interview with Blount.

⁵⁸ Interview with Marks, 2003.

Intelligence Operations at CFLCC

On September 27, 2002, Major General James A. Marks was put in charge of CFLCC intelligence as the C-2. He immediately began preparing for deployment to Kuwait, meeting with senior Army and national intelligence officials and making plans to expand CFLCC's organizational structure.⁵⁹ On September 29, CFLCC–Forward's Deputy C-2 and the 297th Military Intelligence Battalion's Joint Analysis and Control Element (JACE) chief gave the first detailed briefing on Baghdad to CFLCC's Deputy Commanding General, Major General William Webster.⁶⁰ The immediate task for CFLCC's C-2 was to integrate physically dispersed intelligence functions at Camp Doha and to design a new Combat Operations Intelligence Center in time for the start of OIF.⁶¹

The newly deployed JACE was in place when terrorists fired on marines training at Falaka Island off the Kuwaiti coast. The JACE chief acted as a conduit to retask Predator to support the marines. He communicated with the Marine battalion's S-3 via SIPRNET chat and reported what he saw on his live Predator feed. At the same time, he coordinated with CFACC operators at Prince Sultan Air Base in Saudi Arabia to redirect attack aircraft to the area.⁶² This episode provided an opportunity to exercise what would soon become important tactics, techniques, and procedures for joint time-sensitive targeting.

By May 2003, CFLCC had begun to shift its focus to stability and support operations (SASO), and planning the transition of command and control to CJTF-7.⁶³ Accordingly, within CFLCC's C-2, the HUMINT Analysis and Reporting Cell took on greater importance and, in conjunction with other staff elements, began to focus on maintaining databases of enemy personnel, prepared HUMINT link analysis diagrams, and began tracking HVTs. The JACE, soon to become the Combined Analysis and Control Element, or CACE, to reflect the growing number of coalition analysts within its confines, began to adapt its internal organization for SASO by adding ana-

⁵⁹ Marks arrived at Camp Doha, Kuwait, on October 15, 2002. Interview with Major General James A. Marks, Arlington, VA, May 2004.

⁶⁰ This briefing was known as "Project 29." It presented potential CFLCC courses of action that could contribute to early regime collapse.

⁶¹ CFLCC Headquarters had reportedly experienced significant difficulty during ENDURING FREEDOM with staff interaction and information exchange.

⁶² U.S. Army Intelligence Center and Fort Huachuca, *Intelligence Officer's Battlebook*.

⁶³ The Coalition Provisional Authority (CPA) was established in Iraq in June 2003 to administer the country, and the coalition forces on the ground were directed to secure the peace. Combined Joint Task Force 7 (CJTF-7) was established on June 12, 2003, to undertake that mission. When the CPA mission ended in June 2004, the military mission became even more complex because the military was then required to consult with the Iraqi interim government. CJTF-7, with its headquarters co-located with the CPA, consisted of the V Corps headquarters and V Corps units in country at the end of major combat operations. See Chapter Eight for a more detailed discussion of postwar operations.

lytical teams for political and religious groups and tribes. An Open Source Intelligence Team was formed to provide a daily summary of reporting on Iraq from regional sources; its work complemented V Corps' effort inside Baghdad, which produced papers like the "Baghdad Mosquito."

Dissemination

Even the best intelligence information is worthless if it does not get to those who need it in time to be useful. To be effective, a centrally managed collection and processing system such as was used in OIF must know what information the tactical commanders need at any given time. When the information needs of lower levels are not known, the solution is often to attempt to disseminate everything. Indeed, this was the case with the ASAS, as mentioned earlier. But this only compounds the problem: First, the bandwidth required may not be available; and second, if the local commanders receive the information and if it is current, they may be reluctant to sift through it all for what they need at the moment. For this reason, they generally resort to using their organic assets to develop needed intelligence. This was indeed the case in OIF.

Dissemination on the Move

Once combat operations began on March 19, 2003, the ability of tactical units to receive regular, useful intelligence updates depended heavily on the communications assets available. Regardless of the quantity and quality of intelligence products, once ground forces crossed the line of departure, intelligence support deteriorated because the wideband communications systems needed to receive intelligence products were not always available. Consequently, the COP produced by the ASAS was not disseminated to and among tactical units in a timely manner, and therefore its utility was limited. Only when the units stopped were they able to gain access to intelligence—provided the unit had access to sufficient bandwidth. Even then, the amount of data to be downloaded frequently exceeded the capacity and time available.

Automated systems often took too much time to boot up; with the pace of ground maneuver, intelligence analysts typically had only a few hours to process any backlogged intelligence, surveillance, and reconnaissance data from combatant and theater command centers that had accumulated while they were on the move. For example, the 2nd Brigade's G-2 (from the 3rd Infantry Division) reported that on one occasion it took him 13 hours to download SIPRNET email from higher headquarters after an extended "blackout period," experienced while the brigade was on the move. Major General Blount, the division commander, recounted stopping only four times over a 21-day period, not enough time for his TOCs to set up and process fully all the enemy intelligence data available from V Corps' fixed location at Camp Virginia and the CFLCC.

The most critical problem was the inability to track enemy forces and gain current estimates of their strength. Commanders received reports of hundreds of Iraqi

prepared positions along the two main avenues of approach to Baghdad but little information on the strength of the defenses at those positions or the movement of enemy forces. As it turned out, few of the positions were manned or defended.⁶⁴ In addition, very few enemy forces were moving to reinforce these positions.

The lack of actionable intelligence meant that knowledge of the enemy force's strength and disposition deteriorated as forces moved closer to Baghdad. For example, both V Corps and 3rd Infantry Division commanders said that as they prepared for one of the key engagements of the operation, the push through the Karbala Gap, they had little current intelligence on where the Medina or Hammurabi Divisions were located, their overall strength, or details on their key capabilities.⁶⁵

The Common Operational Picture

The common operational picture of the battlespace is a pictorial depiction of the current location of both friendly and enemy forces.⁶⁶ Figure 7.7 is an example taken from April 9, 2003, just before the end of major combat operations. It depicts the location of Army and Marine Corps forces in Baghdad along with the current estimates of the location of enemy forces.⁶⁷ The disposition of friendly forces in OIF was obtained by field reports and from Blue Force Tracker. Enemy locations were obtained from surveillance assets and intelligence production.

The COP became extremely important to OIF commanders at higher echelons in gaining awareness of the situation in the battlespace. Since it is electronically produced, it has the potential to be current.

The CENTCOM staff focused on improving both the quality of the COP and its production. For example, an improved depiction on the map being generated was accomplished by using the command and control personal computer (C2PC). By the time OIF began, the product had improved considerably. As early as October 2002, CFLCC C-2 systems staff and the Communications Electronic Command support

⁶⁴ Interview with Colonel (USA) Curtis D. Potts, Commander, 4th Aviation Brigade, 3rd Infantry Division and staff, Fort Stewart, Georgia, October 29, 2003.

⁶⁵ Interview with Wallace, 2003. Interview with Blount. This was further confirmed by Colonel Bill Wolf, Commanding Officer of the 11th Attack Helicopter Regiment: "The lack of good intelligence was a problem. What we had was a template of the Medina Division." A template is an intelligence officer's estimate of how an enemy unit might align itself, in this case, to defend against an attack. This estimate is based on the most recent observations of the unit in the area.

⁶⁶ The COP is best described as a distributed data processing and exchange environment that develops a consistent tactical database of objects; each participant can contribute, rectify, and add value to this data base according to his sensor field of view, processing domain expertise, and command role.

⁶⁷ The COP depicted in Figure 7.7 is the view seen at CFLCC Headquarters at Camp Doha in Kuwait. It is interesting to note that a day later on the 10th, elements of the 1st Marine Division's Regimental Combat Team 5 were engaged in a severe battle with Fedayeen in Saddam City (depicted on the map). However, this COP does not indicate the presence of any enemy forces in the area, which highlights the difficulty of gaining intelligence on small forces such as the Fedayeen. For a full account of this battle, see Chapter Four.

Figure 7.7
The Common Operational Picture for April 9, 2003

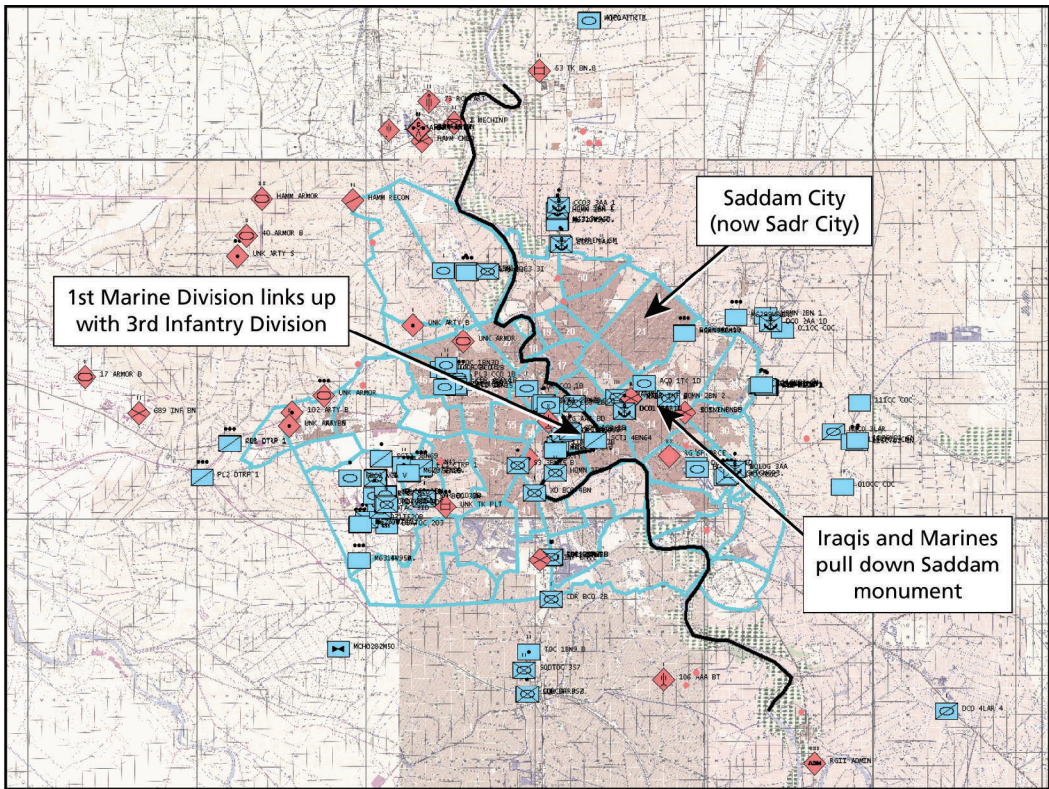

SOURCE: Image courtesy of CFLCC, Camp Doha, Qatar.

RAND MG641-7.7

contractors from the 513th Military Intelligence Brigade had attended a COP Working Group at MacDill Air Force Base, Florida, that set the software and systems base-lines for the theater.⁶⁸

Commanders on the move at corps and below were to rely on the COP produced by the ASAS. But because of the problems with the ASAS mentioned above, they generally found it to be of limited value. The reason for this was that the unit symbol depiction of enemy forces on the map was generally considered too coarse. What was needed was a more detailed representation of the location of enemy fighters within cities and elsewhere. A COP that focused solely on the receiving unit's area of operations might have helped, but unfortunately, the COP produced for CENTCOM and the ASAS could not be tailored in this way. Each recipient received the entire COP. In addition, because of the bandwidth required to transmit the COP, commanders

⁶⁸ U.S. Army Intelligence Center and Fort Huachuca, *Intelligence Officer's Battlebook*.

on the move had difficulty accessing it. Access to wide-bandwidth communications systems such as tactical satellite (TACSAT) was almost nonexistent at division and below.

One of the chief complaints from analysts in CENTCOM's Joint Operations Center (JOC) was that the JOC's Track Management Cell put too much enemy "red" data on the screen, making it too confusing to consult. This was essentially a "level-of-resolution issue." At low levels of resolution, i.e., when the COP consisted of nearly the entire area of operations, the number of icons depicted was large and they were likely to overlap, thus causing confusion. A depiction of the COP that was focused on a small segment of the battlefield showed fewer icons and each could be distinguished. In addition, at the higher levels of resolution, movement of forces was more discernable. Several senior commanders had to be educated on these points.⁶⁹

Because of limited communications, timely access to the COP was limited to commands at fixed facilities. Given the COP's magnitude, it was nearly impossible to feed to the tactical level from either CFLCC at Camp Doha, Kuwait, or V Corps at nearby Camp Virginia.⁷⁰ For example, the 1st Marine Division's lessons learned report on OIF said the following:

There is currently no reliable way to pass data down to the battalion level or to the regiment while on the move. There are times when it took days for email messages to reach regiments due to server queues or some such. Although on the surface a communications issue, the impact on timely, actionable intelligence is severe.⁷¹

Comments from other tactical units echo these remarks. Members of the 3rd Infantry Division's 103rd Military Intelligence Battalion remarked, "The rate of advance was much too fast for the divisional [communications] to deal with. This hindered the ability to get intelligence products down to lower levels and for lower levels to pass their information up the chain of command."⁷² This applied equally to the Army's ASAS-generated COP. An inability to disseminate the COP in a timely manner also contributed to the digital divide.

⁶⁹ Interview with Marks, 2003. It is important that the issue of appropriate resolution be addressed if the COP is to remain a viable tool for gaining situational awareness.

⁷⁰ Interview with Marks, 2003.

⁷¹ 1st Marine Division, "Operation Iraqi Freedom (OIF) Lessons Learned."

⁷² Interview with members of the 103rd Military Intelligence Battalion, Fort Stewart, Georgia, October 28, 2003.

The Situational Awareness Lessons

The digital divide experienced in OIF prompted Lieutenant General Wallace, Commander, V Corps, to observe that the military is very good at developing systems to support the intelligence and information needs of general officers at their command posts, but not the needs of small unit commanders on the move at the lower tactical levels.⁷³ His meaning is clear: when it came to providing the lower-level (brigade/regiment and below) tactical commander with the actionable intelligence he needed, military intelligence systems were found wanting. As has been the case for centuries, however, tactical commanders adapted to the situation by implementing workarounds that reduced their need for intelligence from external sources.

The most obvious adaptation was the reliance on heavy armor to make up for the lack of situational awareness. Even the 101st Air Assault Division and the 82nd Airborne Division requested and received M-1A1 tanks from the 3rd Infantry Division. If the enemy is to be discovered by running into him, then the prudent commander will insist on the maximum force protection available: the main battle tank.

Even if sufficient bandwidth were available to transmit current versions of the COP, it is not clear that it would be useful to the tactical commander. Red and blue icons on a digital map may be fine at division and higher, but tactical units engaged in urban warfare in Iraq's major cities needed more—even had the COP been tailored to their area of operations. They needed to know which building the enemy was hiding in or behind. Moreover, in an era in which inflicting noncombatant casualties is deemed nearly as bad as suffering friendly losses, the commander needs to be able to distinguish between enemy fighters and innocent civilians. And since this enemy deliberately hid its identity as future enemies are also likely to do, no current or future sensor is likely to provide the discrimination required.

The military should evaluate carefully just what information the tactical commander needs in operations such as OIF. If this information can best be obtained at the tactical level, then adequate sensors should be made available to make this happen. In many cases, this will mean using the heavy tank to draw fire, because discriminating enemy combatants from innocent bystanders is next to impossible. It may also mean the selective fielding of tactical UAVs coupled with more aggressive armed helicopter and fixed-wing reconnaissance.

In any event, the military should recognize that intelligence is generated both at the top and at the bottom and that dissemination is a two-way street. Although national assets and the more sophisticated sensor suites will likely serve strategic and operational goals primarily, the intelligence they produce should be made available to tactical commanders in a form that they can use. At the same time, tactical commanders relying on their allocated and organic assets should continue to provide intel-

⁷³ Interview with Wallace, 2003.

ligence they gain to higher levels. In this way, the digital divide can be bridged. Even as we develop more sophisticated and capable sensor systems to support collection at the highest level, we must provide lower-echelon units with more organic intelligence-collection capabilities as well.

Space Operations

Space operations played a more important role in OIF than in any previous conflict. The space systems supporting the operation were abundant, and many were significantly more capable than those available in the first Gulf War. Most importantly, space-based capabilities were integrated into U.S. military operations—to enhance situational awareness at fixed sites, as discussed above, and to provide commanders with an improved ability to control and coordinate operations and to conduct precision strikes.

Yet despite many advances, the space community had yet to become a mature member of the joint warfighting team in OIF. After DESERT STORM, unified and service-component space commands reorganized to provide more effective support to conventional warfighters, but space operations command and control relationships were in flux up to the opening day of the war and remained vague throughout the conflict. Communications providers managed to obtain a remarkable supply of satellite bandwidth to support the many needs of expeditionary, rapid-maneuver warfare, but the bandwidth available to ground forces below division fell far short of demand, as already mentioned. Moreover, the Army did not provide satellite communications receivers and GPS-enabled equipment of all types in adequate numbers to support maneuver forces at brigade level and below.

Organization and the Command and Control of Space Forces

When space capabilities first emerged in the early 1960s, satellites were used almost exclusively to collect intelligence for national agencies, provide early warning of strategic nuclear attack, and support communications for command and control of U.S. nuclear forces. As the Cold War drew to a close, several trends combined to complicate the command and control relationships previously established to manage space systems.

- First, technological advances made it advantageous to perform an increasing number of military and civil functions from space. This brought new stakeholders, each of them wanting some degree of control over the systems supporting their missions.
- Second, the regional instabilities that surfaced at the end of the Cold War provided an impetus to harness existing space systems.

- Finally, a commercial space sector developed to serve several markets—most notably, communications and spectral imaging—that were previously the exclusive domain of government-owned systems.

These trends ultimately combined to create an environment in which a satellite might be owned by one agency and operated by another. Complicating matters further, the same space system might be employed to support multiple customers.

As early as 1973, anticipating the support that national space systems might provide to conventional military operations, the U.S. Army Space Program Office took responsibility for managing a program to investigate the tactical exploitation of national capabilities, or “TENCAP.” In 1982 the U.S. Air Force deactivated the Air Force Aerospace Defense Command and moved its space systems management functions to the newly created Air Force Space Command. The U.S. Navy activated its Naval Space Command the following year. These two commands comprised the service components of the first unified command for space, U.S. Space Command, which the Joint Chiefs of Staff created in 1985. The Army activated its service component, Army Space Command, in 1986.

DESERT STORM demonstrated how ill suited the rigid, national space infrastructure and command and control systems were for supporting tactical users. The military space community rushed to adapt systems to support the tactical needs of theater commanders. Among the many important outcomes of the DESERT STORM experience were concerted efforts to modify existing space systems and develop new ones to support tactical users, break down the classification barriers that hindered getting intelligence products to the battlefield, develop a cadre of military space operators with a warfighting orientation, and establish command and control relationships between space and theater commanders.

Shortly after 9/11, as space forces prepared to support ENDURING FREEDOM, the commander of U.S. Space Command determined that authority to coordinate space support in the theater would reside with CENTCOM’s Space and Information Operations Element (SIOE). On March 18, 2003, just hours before OIF’s opening strike, General Franks published an order designating the CFACC as Space Coordinating Authority (SCA). The CFACC then delegated that role to the senior space officer in the CAOC.

Space Contributions

In many respects, space operations are inherently more “joint” and more “network-centric” than any other military function. As spacecraft and their payloads are so often owned by one agency, operated by another, and employed to support multiple missions and tasks, it is often impossible to evaluate their contributions purely from a single-service or organization perspective. Likewise, all space systems are true network operations. Even when a given product comes from a specific space platform, that plat-

form cannot operate in isolation. It is controlled and supported by a global network of ground stations and processors that must be orchestrated to produce a space effect for a local supported commander. Therefore, in order to fully appreciate what space operations contributed in OIF, we must evaluate those contributions from a functional perspective. In this section, we examine the contributions that space systems provided to communications; positioning, velocity, navigation, and timing (PVNT); and missile detection and warning.⁷⁴

Satellite Communications

Satellite communications are the backbone of modern military operations. Advances in tactics and technology have placed an ever-growing demand on mobile communications and machine-to-machine data transfer. Senior commanders and their staffs have become increasingly dependent on digital networking, Internet connectivity, and battlefield videoconferencing. Desires for greater situational awareness and abilities to coordinate simultaneous, rapid operations in an expanding battlespace drove demands in OIF for Blue Force tracking, use of UAVs, and other bandwidth-intensive services. Efforts to provide sensor-to-shooter connectivity evolved into a growing demand for direct sensor-to-weapon linkages. Consequently, demands for bandwidth grew more than twentyfold since DESERT STORM (see Figure 7.8). The dynamics of high-speed maneuver warfare and the need to provide “reach-back” support to expeditionary operations made satellite communications the only viable solution for many bandwidth requirements.

Due to the need to support numerous installations in the region as well as SOUTHERN WATCH, communications service to CENTCOM was already quite robust by 9/11. However, as forces deployed to the region for ENDURING FREEDOM, demands for bandwidth soared, quickly absorbing the capacity available from both military and civilian systems. Communications support from satellites was an immediate concern. Secure connectivity between command centers and ships afloat for such functions as SIPRNET, real-time chat, and videoconferencing was essential.

Positioning, Velocity, Navigation, and Timing (PVNT)

Space-based PVNT is a service that has become almost as indispensable in modern warfare as satellite communications. First capturing public attention in DESERT STORM, the Global Positioning System, the PVNT provider to U.S. and coalition forces, grew from a 16-satellite partial constellation, which provided data for nearly continuous two-dimensional location calculation and intermittent, 19-hour-per-day, three-dimensional positioning in that conflict, to a mature constellation of 24

⁷⁴ Space operations also supported reconnaissance satellites operated by several national agencies.

Figure 7.8
Satellite Communications Supporting CENTCOM in Four Operations

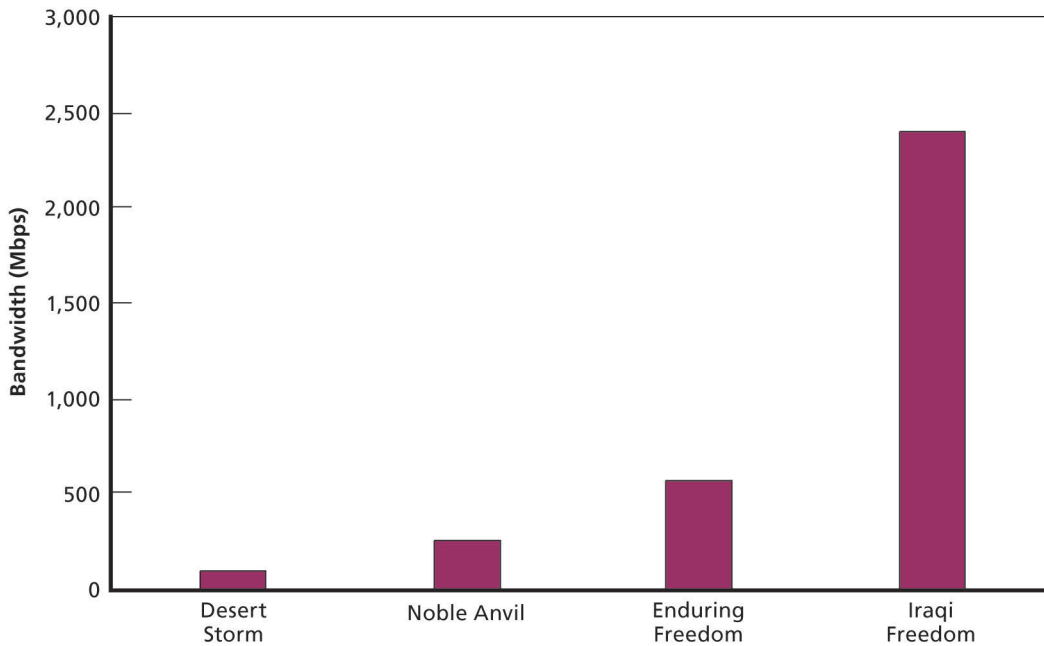

RAND MG641-7.8

operational satellites (and several on-orbit spares) that provided continuous three-dimensional PVNT support in OIF.⁷⁵

Throughout OIF, the GPS consisted of three components that, together, supplied data for a wide range of military and civilian functions. The space segment consisted nominally of a constellation of 24 satellites in 12-hour, circular orbits arranged in six orbital planes to provide continuous global coverage (every spot on the globe is within view of at least four satellites). These satellites were monitored and operated by the control segment, consisting of a Master Control Station and GPS Support Center at Schriever Air Force Base, Colorado; ground antennas at Ascension Island, Diego Garcia, and Kwajalein; and monitor stations at Ascension Island, Colorado Springs, Diego Garcia, Hawaii, and Kwajalein. The satellites provide data to the user segment, a wide variety of receivers, fixed and mobile, handheld and vehicle-mounted, in terrestrial and space environments. GPS data were used to calculate three-dimensional navigation information—including position, velocity, and timing—for military and civilian users. GPS also provided precise timing for individual computer systems and

⁷⁵ At the onset of DESERT SHIELD, U.S. Army Space Command provided 500 Small Light GPS Receivers (SLGR) to the deploying 82nd Airborne Division and 101st Air Assault Division, then joined Air Force Space Command and the GPS Joint Program Office in a crash effort to procure and deploy additional receivers. By March 1991, 842 military receivers and 4,490 commercial units were supporting U.S. forces in the Gulf.

for synchronizing communications and computer networks. In OIF, GPS supported many military capabilities not yet developed in DESERT STORM. A wide range of precision-guided weapons was fielded after the first Gulf War that used GPS PVNT for target acquisition and in-flight guidance. Precise location and timing data also supported a host of other functions, from survey and mapping to mine and sensor emplacement.

One measure of the importance of PVNT to the coalition’s success in OIF was the large number of air munitions expended that employed GPS guidance systems. A total of 7,049 bombs and air-to-surface missiles used in OIF—approximately 25 percent of total air munitions expended—were equipped with GPS guidance systems. That is more than was used in any previous conflict, though the percentage is somewhat lower than that for ENDURING FREEDOM (see Figure 7.9).⁷⁶

A total of 28,396 air-delivered bombs and missiles were employed in OIF. In addition to the 25 percent that had GPS guidance systems aboard, 43 percent (12,220) were guided by other means, and only 32 percent (9,127) were unguided (see Figure 7.10). These numbers do not include cruise missiles.

During OIF the Combined Air Operations Center at Prince Sultan Air Base, Saudi Arabia, tasked the space community to employ “special tactics” to maximize GPS accuracy for specified periods to support critical precision strikes. In response, the 14th Air Force’s 2nd Satellite Operations Squadron implemented GPS Enhanced Theater Support (GETS), a routine in which satellites were transmitted updated ephemeris and clock adjustments just before entering the theater, thereby reducing user range error, a source of degradation in navigation solutions. Data that the 2nd Satellite

Figure 7.9
Growth in Use of GPS-Guided Air Munitions

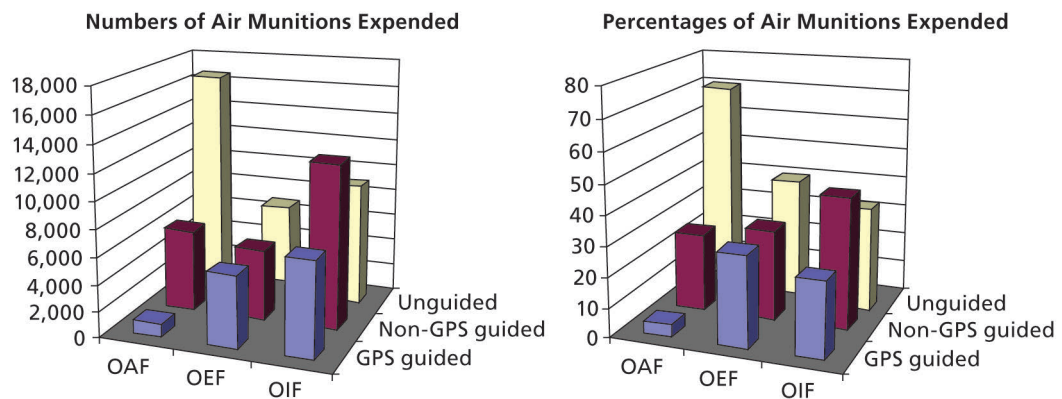

RAND MG641-7.9

⁷⁶ Moseley, “Operation IRAQI FREEDOM—By the Numbers,” p. 11.

Figure 7.10
Percentage of GPS-Guided Air Munitions as Compared to Non-GPS-Guided and Unguided Air Munitions Expended

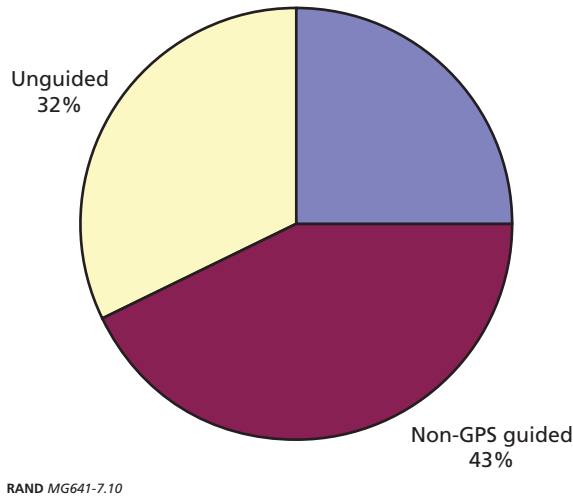

Operations Squadron collected between February 12 and April 16, 2003, indicate that GETS resulted in a 31 percent reduction in navigation solution spherical error probable at the 95 percent confidence level.⁷⁷

Another indication of the importance of GPS in OIF was the pervasive presence of GPS receivers among coalition ground forces. In DESERT STORM the U.S. Army managed to field one Small Light GPS Receiver (SLGR) for every 180 soldiers, or about one per company. In OIF the Army provided its troops more than 100,000 Precision Lightweight GPS Receivers (PLGR), or one per nine-soldier squad. The Marine Corps fielded 5,400 PLGRs, or about one per platoon.⁷⁸ In addition, some soldiers and marines bought their own commercial GPS receivers. The commercial units lacked the capability to process the encrypted military signal, so they were less accurate and more vulnerable to jamming and spoofing. However, soldiers preferred them to military models because they were lighter, used less power, and provided navigation solutions faster.⁷⁹ GPS receivers were installed in many vehicles, and they were essential components in such systems as target designators and range finders, space-based Blue Force Tracker sets, and FBCB2. Even so, despite the dramatic increase in the availability of GPS-related equipment for ground forces since the first Gulf War, the most frequent

⁷⁷ 2nd Space Operations Squadron, "GETS Performance Improvement in SW Asia: 20 Mar–16 Apr 2003," briefing, undated.

⁷⁸ Seth Schiesel, "On the Ground in Iraq: The Best Compass Is in the Sky," *New York Times*, April 17, 2003.

⁷⁹ "Soldiers Find—Again—They Need Faster, Easier Access to GPS," *Inside The Army*, June 30, 2003, p. 1.

complaint in OIF after action reports was that there simply was not enough of it to meet the Army's needs.

Missile Detection and Warning

Ever since the first Gulf War, in which Saddam Hussein fired SCUD missiles into Saudi Arabia and Israel in an effort to disrupt the coalition's political cohesion, missile defense has been an important concern in any anticipated conflict with Iraq. As discussed in Chapter Three, this concern was heightened by the belief that Saddam might have the option to deliver chemical or biological agents with ballistic missiles. Missile detection and warning is a key component of missile defense, and space surveillance plays an important role in that function along with other surveillance assets such as airborne and surface-based radar. In OIF, the Satellite Early Warning System (SEWS), a network of Defense Support Program (DSP) satellites and their supporting ground stations and communications infrastructure, provided space surveillance support to CENTCOM's theater missile detection and warning effort.

In the years between DESERT STORM and IRAQI FREEDOM, several improvements were made to the SEWS to enable it to better support conventional warfighting operations. In 1995, ground processing systems were upgraded to improve their ability to detect small missiles. The improvised bent pipe communications⁸⁰ arrangement was replaced with a more reliable Tactical Event Reporting System that transmits reports over the Integrated Broadcast System–Simplex and Integrated Broadcast System–Interactive. Most significantly, the U.S. Army Space and Missile Defense Command developed a deployable DSP ground processing system, the Joint Tactical Ground Station, to directly support theater warfighting operations.

Army Space Support to OIF

The U.S. Army Space and Missile Defense Command provided space operations support to OIF through standing organizations with well-established missions, such as the 1st Satellite Control Battalion that operated the payloads aboard Defense Satellite Communication System (DSCS) satellites, and by quickly organizing, training, and equipping Army Space Support Teams and deploying them to support Army, Marine Corps, and SOF units in the theater. The Space and Missile Defense Command also deployed a portable spectral analysis unit, provided operators for Joint Tactical Ground Stations and Joint Space Support Teams, and sent space liaison officers to several command centers. Army space operators in the field reached back for extensive support to the Space and Missile Defense Command Operations Center (SMDCOC), which channeled their requests to appropriate agencies inside and outside of the command. The command agencies most heavily engaged in servicing field requests included the

⁸⁰ A "bent pipe" communications architecture is one that relays data via satellite with no onboard processing of those data. In a bent pipe, data are transmitted to the satellite, which simply receives and retransmits the data.

Spectral Operations Resource Center, which obtained, processed, and forwarded imagery from commercial satellites; the Space and Missile Defense Command Battle Lab, which serviced maintenance requests and provided other forms of logistical support; and the Blue Force Tracking Mission Management Center, which handled all Blue Force Tracker–related information requests (see the section on situational awareness above).

The 1st Satellite Control Battalion based in Colorado Springs, Colorado, commanded six companies that managed the DSCS network from operations centers in five locations around the world. All of these operations centers supported OIF to some extent, but Company B, which controlled 125 terminals with 15 tactical communications missions from its operations center at Fort Meade, Maryland, and Company C, with 96 terminals and 58 tactical missions in Landstuhl, Germany, were the most heavily engaged. DSCS satellites provided SIPRNET, NIPRNet (Non-classified Internet Protocol Router Network), and voice connectivity and videoconference capabilities to combatant commanders throughout the theater as well as to U.S. command centers and numerous ships afloat. The DSCS network provided 90 percent of all protected communications to combatants in OIF and 70 percent of all military satellite communications in the theater.⁸¹

In addition to supporting OIF from standing units at fixed operations centers, the Space and Missile Defense Command deployed more than 100 soldiers to the theater, many as members of Army Space Support Teams from the 1st Space Operations Battalion and a unit of the Colorado National Guard, the 193rd Space Operations Battalion. Partway through the war, the battalions were made subordinate units of a newly created 1st Space Brigade (Provisional).⁸² The Space and Missile Defense Command also supported joint efforts, providing operators for Joint Tactical Ground Stations and Joint Space Support Teams, and deployed Army space liaison officers to several command centers.⁸³

Army Space Support Teams and other Army space operators at key locations in theater were equipped with a suite of portable data processing and communications equipment called Space Support Element Toolset–Light (SSET-L). SSET-L was the product of a rapid prototyping effort by the Space and Missile Defense Command Battle Lab in response to a request for forces and supporting equipment that Special Operations Command Central Command submitted to the Space and Missile Defense Command via Strategic Command in November 2002. In less than three months,

⁸¹ Lewis Bernstein and Roy McCullough, “Space and Missile Defense Command Contributions and Lessons from Operation Iraqi Freedom,” and Mearen Betha and Garth Hahn, “1st Satellite Control Battalion: Silent Support to the Warfighter,” *The Army Space Journal*, Vol. 2, No. 3 (Special Edition), 2003, pp. 36, 50–51, and 68.

⁸² The 1st Space Brigade was provisionally activated on April 10, 2003.

⁸³ Scott Parks, “1st Space Brigade (Provisional): Brigade Operations During the War,” *The Army Space Journal*, Vol. 2, No. 3 (Special Edition), 2003, pp. 18–19, 71.

the Battle Lab delivered five SSET-Ls to the SMDCOOC, Spectral Analysis Resource Center (SORC), SORC-Forward (supporting SOCCENT with Spectral Exploitation Cell–Transportable [SPEC-TR]), and two other deployed Special Forces units. Over the course of the war, the Battle Lab fielded 12 SSET-L suites to deployed forces.⁸⁴

Five Army Space Support Teams deployed to OIF between February and May 2003. The first three teams deployed to Kuwait in February to support the CFLCC, V Corps, and the 1st Marine Expeditionary Force. Army Space Support Teams typically consisted of six members: a space operations major who served as team leader, a space operations captain, an intelligence captain, a satellite control sergeant, a topography sergeant, and an information systems specialist. The CFLCC and V Corps kept their teams largely intact, supporting the headquarters staff, but when decisive operations began, the Marine Corps divided their six-member Army Space Support Team into three groups of two, supporting their rear, main, and forward command posts. With the transition to stabilization operations, the 1st Space Brigade (Provisional) deployed a fourth Army Space Support Team to Baghdad to support the Office of Reconstruction and Humanitarian Assistance (ORHA) and a fifth team to serve as a prototype Divisional Space Support Element with the 4th Infantry Division in Tikrit, testing the Army's ability to provide space support at an echelon below corps.⁸⁵

Army Space Support Teams offered a range of products and services to the organizations with which they were deployed. The main items they provided were commercial images, maps, and a variety of spectral analysis products. They also offered, and in some cases provided, services such as advance notice of satellite overflights, forecasts of space and terrestrial weather effects on satellite communications, assistance in communications interference analyses and deconfliction, GPS accuracy predictions and analyses of interference and jamming impacts, missile warning and defense systems liaison, and health and status monitoring of supporting satellite constellations. But the results of their efforts varied. No two teams had the same relationship with the organizations they supported. Ironically, the one task that every team found most demanding was the effort to educate warfighters on who the Army Space Support Teams were, why they were there, and how they could support the operational mission.⁸⁶

⁸⁴ Interview with U.S. Space and Missile Defense Command Battle Lab, Peterson Air Force Base, Colorado, April 7, 2004; Jeffrey Souder, "Space Support Element Toolset, etc. . . . Rapid Prototyping Support to Army Space Forces," *The Army Space Journal*, Vol. 2, No. 3 (Special Edition), 2003, pp. 22–23, 65.

⁸⁵ Interviews with U.S. Space and Missile Defense Command Battle Lab, Army Space Support Teams 1, 3, 5, and 14, Peterson Air Force Base, Colorado, April 8, 2004. Also see Eric Henderson, "Space Support Cell: Riding Space in the Iron Horse Division," *The Army Space Journal*, Vol. 2, No. 3 (Special Edition), 2003, pp. 20–21.

⁸⁶ Interviews with U.S. Space and Missile Defense Command Battle Lab, Army Space Support Teams.

Battle Damage Assessment

A decade of dueling between Iraqi air defenses and coalition air forces enforcing the southern no-fly zone in SOUTHERN WATCH provided ample opportunity for CENTCOM to hone its processes for battle damage assessment (BDA) in the Iraqi theater of operations.⁸⁷ Unfortunately, neither SOUTHERN WATCH nor ENDURING FREEDOM in Afghanistan was adequate preparation for the challenges of providing timely, accurate assessments of battle damage and battlefield effects in a fast-moving, high-volume campaign like OIF.⁸⁸

It was decided early in the planning process that there would be a single official assessment of battle damage for the theater—there were to be no competing assessments. To this end, General Franks was the final authority for all BDA issues in the central region, and the CENTCOM Director of Intelligence (J-2) was the executive agent for BDA. The primary responsibility for BDA analysis, production, and dissemination resided with CENTCOM's BDA Branch, a subsection of Targets Branch.

What Is BDA?

Battle damage assessment is defined as “the timely and accurate estimate of damage resulting from the application of military force, either lethal or nonlethal, against a predetermined objective.”⁸⁹ It is primarily a responsibility of the intelligence community, with inputs and coordination from the operators. Battle damage assessment consists of three phases:

- **Phase I: physical damage assessment.** This is an estimate of the extent of physical damage to a target resulting from the application of military force. Phase I BDA reports summarize the results of these assessments and can be based on a single source of data.
- **Phase II: functional damage assessment.** This is an estimate of the effect of military force on the functional or operational capability of a target to perform its intended mission and of the level of success achieved relative to established targeting objectives. Building on Phase I BDA, these assessments utilize fused, all-source information. Phase II BDA reports summarize the results of functional damage assessments and may include reattack recommendations when necessary.
- **Phase III: target system assessment.** This is a broad assessment of the overall impact and effectiveness of the application of military force against the operation

⁸⁷ The term *bomb damage assessment* is generally used to mean the assessment of damage as a result of bombing. *battle damage assessment* is also used in this context, but it is generally broader in that it includes damage done by surface-to-surface weapons such as artillery and ground force operations. In this work, we use the two terms interchangeably.

⁸⁸ “Volume” refers to the number of bombing events that result in targets requiring assessment.

⁸⁹ U.S. Department of Defense, Joint Publication 1-02, *Department of Defense Dictionary of Military Terms*.

of an enemy target system⁹⁰ or total combat effectiveness relative to the operational objectives established. Building on Phase II BDA, these assessments utilize fused, all-source information. Phase III BDA reports summarize the results of target system assessments and may include reattack recommendations when necessary.

The BDA Process in OIF

Added to the complexity of prosecuting a campaign is the need to assess its effectiveness, particularly that of indirect fires, which include both air-delivered munitions and long- and short-range artillery. The primary means available to assess damage done to targets, in advance of ground forces inspecting for damage, are sensors. Unfortunately, these sensors are also used to gain intelligence needed to support advancing forces and, in OIF, to hunt for WMD, surface-to-surface missiles (SSM), and high-value targets (HVTs).⁹¹ This set up a competition in which, as discussed below, BDA received a lower priority ranking. Inevitably, tension arose between using sensor assets for ongoing operations and using them for BDA.

Assessing the effectiveness of a bombing campaign is important because of the risk entailed in restriking targets for which an assessment is not available or is inconclusive. This is particularly problematic when the target is a high-collateral-damage target. In addition, restriking targets wastes resources. Fortunately, in this campaign, the enemy generally abandoned equipment rather than face air strikes and superior coalition firepower. Consequently, the lack of timely BDA, in this fast-moving campaign, was considered generally irrelevant.

Managing the BDA process is yet another of those complex command and control processes that absorbs time and resources. Sophisticated software is used to record the status of targets attacked by air assets. Damage assessments are based on mission reports from the aircraft crew, sensor reports (if available), and first-hand observations by ground forces or munition effectiveness teams. In OIF, the general consensus was that effective BDA was sorely lacking.

Split Operations

To provide direct BDA support to General Franks at CENTCOM Headquarters Forward in Qatar, the CENTCOM BDA Branch implemented a split operations scheme. A small group of BDA analysts deployed forward to form CENTCOM BDA Branch (FWD) while the majority remained in Tampa as CENTCOM BDA Branch (Main).

⁹⁰ According to the *Department of Defense Dictionary of Military Terms*, a target system may be defined as a group of functionally related targets situated in a particular geographic area or as a group of targets related in a manner that their destruction will produce some desired effect, for example, a missile launch facility and its accompanying radar site.

⁹¹ In IRAQI FREEDOM and ENDURING FREEDOM before it, the term *HVT* was reserved for high-profile terrorists such as Osama Bin Laden or high-ranking regime officials such as the 55 pictured on the now-famous enemy deck of cards.

In addition to split operations, CENTCOM BDA was to rely on several U.S. military organizations to produce physical and functional damage assessments for certain target sets, thus creating a federation for BDA, i.e., conducting BDA with the assistance of several organizations. However, CENTCOM retained BDA responsibilities for air defense, ground forces and facilities, ballistic missiles, command and control, military supply and storage, and naval forces and ports.

CENTCOM BDA Branch (Main) was assigned as the central node for information flows in the federation. The components were to forward tactical reporting. In turn, CENTCOM BDA Branch (Main) was to forward information useful for Phase I BDA calls to the federated partners and coordinate related intelligence collection requirements.⁹² Federated partners were to produce Phase I physical damage assessment imagery graphics, the associated initial phase interpretation reports (IPIRs), and the Phase II functional damage assessment reports for their assigned target sets.

While the concept of operations gave CENTCOM BDA the responsibility for all BDA assessments of Iraqi naval and air forces, the responsibilities for fielded ground forces were to be divided between CENTCOM BDA and the CLFCC. The components as well as other elements of the Joint Intelligence Center in Tampa could recommend changes to combat effectiveness assessments, but CENTCOM BDA was to make the final adjudication.

The primary tasks of the components were focused on providing timely and accurate tactical reporting to CENTCOM BDA. Such information was useful for Phase I BDA. It was to be forwarded to CENTCOM no later than two hours after mission completion.⁹³

The Process Comes Unhinged

In OIF the BDA process fell behind early in the campaign and struggled to catch up. Average turnaround times for BDA during the conflict were measured in days instead of hours despite the best efforts of analysts.⁹⁴ The lengthy turnaround times were the result of a number of factors, several of which, such as bad weather, were beyond the control of the various players in the BDA process. There were, however, problems in the process that were avoidable. The key shortfalls fell into three categories: reporting and information management, apportionment of collection and exploitation, and manning and training.

Reporting and Information Management. BDA is an intelligence function that requires timely, reliable reporting inputs from and coordination with operators to be

⁹² A BDA “call” is an estimate of the extent of physical damage to a target resulting from the application of military force.

⁹³ U.S. CENTCOM, “CENTCOM BDA SOP,” Appendix H, September 2001, p. 2.

⁹⁴ Lieutenant General Wallace, the V Corps commander, noted that “BDA was 48 hours behind reality.” Interview with Wallace, 2003.

successful. Mission reporting was a key source of information for the BDA process in OIF because so few sorties departed from their bases with preplanned targets listed on the ATO. Between March 19 and April 20, 2003, coalition air forces flew approximately 17,000 strike sorties. The overwhelming majority of these sorties did not have preplanned targets. This mode of operation did not lend itself to BDA collection. Therefore, mission reports became an important part of the BDA process. Unfortunately mission reporting was problematic; some that were not received during OIF were still being found as late as March 2004. Some mission reports that did arrive did not supply enough information to allow any sort of BDA to be accomplished, merely noting that bombs were dropped in a killbox: an area measuring nearly 900 square miles. Worse yet, some mission reports contained conflicting information.⁹⁵ In addition, CENTCOM received very few weapon system videos.⁹⁶

Apportionment of Collection and Exploitation Resources. The collection of intelligence for BDA purposes was another key shortfall during OIF. A major source of BDA was electro-optical imagery. However, this type of imagery was also in great demand to support other functions such as targeting and tracking the dispositions of Iraqi ground forces. The approach to collection management employed by the Joint Collection Management Board apportioned collection resources to the components and did not explicitly apportion collection to support key functions such as BDA (see the discussion of intelligence collection above). As a result, BDA had to compete with other component priorities for limited collection resources.

Circumstances on the battlefield combined to create a nearly insatiable demand for collection assets to locate new targets. The rapid advance of coalition ground forces meant that collection had to be devoted to supporting the advance. Each day, coalition air forces flew large numbers of sorties to locations over the battlefield and orbited on-call, waiting for targets to attack. The search for new targets was also complicated by countermeasures employed by Iraqi forces. The Iraqis had undertaken a huge engineering effort prior to the conflict to prepare alternative locations for their fighting vehicles, weapons, and other essentials such as food, fuel, and ammunition. Each vehicle or weapon had three alternate locations.⁹⁷

BDA collection requests for time-sensitive targets (TSTs) fared better. These collections received a high priority due to high-level interest in TSTs from General Franks. As a result, the timeliness of BDA for strikes against TSTs was substantially better. An analysis of requests for collection of BDA on TSTs and dynamic targets using theater assets indicated that the average time to fulfill a request could be measured in hours, not days.

⁹⁵ Telephone discussion with CENTCOM BDA personnel, May 11, 2004.

⁹⁶ Telephone discussion with CENTCOM BDA personnel, May 11, 2004.

⁹⁷ *Frontline* interview with Lieutenant General Al-Hamdani.

Exploitation is another key, but often overlooked and underresourced, component of support to BDA. Unfortunately, there were fewer imagery analysts in theater during OIF than the number specified in OPLAN 1003V. The combination of this shortfall in imagery analysts with the high volume of imagery data to be analyzed created an intense competition for these limited resources.

Manning and Training. The late arrival of BDA analyst augmentees at CENTCOM was another important contributor to the lengthy turnaround times for BDA. According to the BDA concept of operations, an augmentation package was to be in place at least 60 days before the start of the war. Unfortunately, most of the augmentees did not arrive until just before the start of the war. There was little time, therefore, for the augmentees to familiarize themselves with the operational objectives in OPLAN 1003V, the supporting BDA concept of operations, or standard CENTCOM BDA operating processes and procedures. Although most augmentees were intelligence analysts, they had little or no BDA experience.

The split operations concept also created problems. Chief among them was the lack of adequate communications bandwidth for CENTCOM BDA (FWD). The bandwidth was so limited that they received very few weapon system videos during the war. After repeated failed attempts to send weapon system videos to the forward deployed BDA cell, CENTCOM BDA (Main) gave up. The communications constraints were particularly detrimental since highly experienced BDA analysts manned the forward location. The lack of connectivity limited the degree to which they could reduce the BDA backlog. In addition, the forward deployed BDA analysts could not assist their counterparts in Tampa with mentoring the augmentees.⁹⁸

While the BDA federation did allow additional expertise to be brought to bear on the BDA backlog, it did not come without a cost. Handling information requests from federated partners and tracking down reports and products placed a significant additional workload on the personnel at CENTCOM BDA (Main), detracting from their ability to perform their normal duties. Moreover, CENTCOM lacked direct command authority over the BDA cells of the federated partners. As the war progressed, the normal day-to-day responsibilities of the federated BDA cells began to conflict with and negatively affect the level of BDA support that they were able to provide.⁹⁹

Information Operations

In Iraq and earlier in Afghanistan, information operations became an essential part of combat operations. Psychological operations (PSYOP), a component of today's information operations, gained currency in the Vietnam War, but even as early as the Phil-

⁹⁸ Telephone discussion with CENTCOM BDA personnel, July 9, 2004.

⁹⁹ Notes from the Federated Systems Working Group, BDA Symposium, Suffolk, Virginia, October 22, 2003.

ippine insurrection in the early 1900s, the military conducted humanitarian operations in the hope that the local population would accept them as liberators and help quell any insurrections. In both Iraq and Afghanistan, the goals of ousting a hostile regime and establishing a democratic government friendly toward the West required not only PSYOP to win hearts and minds, but also other means to preserve the nation's infrastructure while convincing enemy forces not to resist. These challenges prompted CENTCOM's commander to designate information operations as one of five fronts in the campaign against Saddam Hussein,¹⁰⁰ thereby bringing into the mainstream what had been merely a sideshow.

Changing Perspective

Information operations (IO) is an umbrella term used to describe a wide range of activities ranging from leaflet drops to attacks against computer networks. The Defense Department lists electronic warfare, psychological operations, military deception, operations security, and computer network operations as the core activities of IO.¹⁰¹ In practice, IO is used to influence enemy forces and the population and, at times, to deny the enemy access to information. While there are many ways to influence the enemy, including traditional fire and maneuver, information operations usually rely on non-lethal means of influence such as deception and psychological operations. Electronic warfare, computer network operations, operations security, and physical destruction are all used to deny the enemy access to communication systems or information. An IO campaign integrates and synchronizes these capabilities to control the information environment during a conflict.

Since the beginning of the 21st century, high-level Defense Department policy and planning documents have indicated that IO should be a core military capability for the future. The 2001 Quadrennial Defense Review identified IO as a military capability that must expand from an enabling to a core capability to meet new threats.¹⁰² The fiscal year 2004–2009 Defense Planning Guidance, which informs resource allocation, directed the services to improve IO capabilities.¹⁰³ These documents emphasized that IO should enter the mainstream of military planning and execution. Subsequently, the IO Roadmap was drafted to guide combatant commands in the planning

¹⁰⁰Franks, pp. 395–396.

¹⁰¹Joint Publication 3-13, *Joint Doctrine for Information Operations*, October 9, 1998, and Lieutenant Colonel Bradley Bloom, "Information Operations in Support of Special Operations," *Military Review*, January–February 2004, pp. 45–49.

¹⁰²U.S. Department of Defense, *Quadrennial Defense Review Report*, Washington, D.C.: GPO, September 30, 2001, pp. 15, 38, 43.

¹⁰³Nick Cook, "Military Priorities and Future Warfare," *Jane's Defence Weekly*, September 11, 2002.

and execution of IO as an integral part of combat operations.¹⁰⁴ It consists of a list of core capabilities that serves to focus IO efforts. OIF lessons are instructive in how IO might need to change to meet its new role.¹⁰⁵

The Plan

Preparations for OIF at CENTCOM emphasized information operations. The Commander's Concept, which directed the planning process, included IO as one of the lines of operations, or means of attacking different targets.¹⁰⁶ As a result, each iteration of CENTCOM's operations plan, including the final version 1003V, included information operations as a key component.

The IO plan for OIF recognized the importance of starting information operations early in the campaign, as part of what it called its Phase I activities to prepare the battlespace in advance of major combat operations.¹⁰⁷ The early IO activities were carried out as part of Operations SOUTHERN WATCH and NORTHERN WATCH; therefore, IO targets were limited by their rules of engagement.

Pre-Combat Operations

The early IO campaign included each of the core capabilities of information operations. Between October 2002 and the start of combat operations in March 2003, PSYOP targeted Iraqi forces and civilians in southern Iraq with leaflets and radio broadcasts. Soldiers were encouraged to desert, not to use weapons of mass destruction and anti-aircraft missiles, and to leave dams and oil wells intact. Messages announced to the Iraqi people that the coalition wished them no harm and cautioned civilians to avoid military areas. Radio broadcasts brought news of world events such as UN Security Council resolutions and stories about Saddam Hussein's regime.¹⁰⁸ Our analysis has not been able to determine the overall effectiveness of pre-combat PSYOP in achieving coalition information goals, but some have used anecdotal reports to argue that the effect was significant. For example, after reading a PSYOP leaflet, the manager of an oil well claims that he shut off the flow of oil to wells rigged with explosives to limit the damage.¹⁰⁹

¹⁰⁴U.S. House of Representatives, *Testimony of the Joint Chiefs of Staff Before the Committee on Armed Services, Regarding the Fiscal Year 2005 National Defense Budget Request for the Department of Defense*, Washington, D.C.: GPO, February 4, 2004.

¹⁰⁵This section focuses on lessons learned during major combat operations from March 19 to May 1, 2003.

¹⁰⁶Franks, pp. 336–339.

¹⁰⁷Woodward, p. 60.

¹⁰⁸U.S. CENTCOM, news releases, November 2002–March 2003.

¹⁰⁹Major Wayne Bergeron, JPOTF Executive Officer, "Joint Psychological Operations Task Force: OEF/OIF," briefing, undated.

Due to legal restrictions, electronic warfare assets could not jam Iraqi tactical communications before the start of major combat operations. Thus, to achieve pre-combat goals, CENTCOM used platforms traditionally used for jamming operations, such as Compass Call, to broadcast coalition PSYOP messages, overpowering Iraqi communications signals.¹¹⁰ One report indicated that the U.S. ability to pinpoint and dominate Iraqi frequencies had a large psychological effect.¹¹¹ Regardless of the effect, widespread use of this technique in OIF represented an improvement of integration and coordination across IO capabilities.

Another example of integration was the use of computer network operations to send PSYOP messages to leadership targets in Iraq.¹¹² Unfortunately, as subsequent interrogation reports with regime leadership attest, attempts to contact them were perceived as loyalty tests from the regime's internal security forces and were therefore ignored.¹¹³

While many military deception techniques are classified, some deception efforts against the Iraqi regime have been discussed openly.¹¹⁴ Deception was used in an effort to sow confusion among members of Hussein's regime.¹¹⁵ For example, when Turkey decided to bar the basing of coalition forces on its territory, General Franks took it as an opportunity to spread confusion about both the timing and the direction of the attack.¹¹⁶ The publicity surrounding the 4th Infantry Division's "plight" combined with other deception efforts may have convinced Saddam that the buildup of coalition forces in the south was a feint. Other deception operations were attempted, to include General Franks's personal hints to Yemen's president that the attacks might come from Turkey or Jordan and the feeding of maps created by CENTCOM's deception cell to the Iraqi regime to convince them that the main attack would come from the north.¹¹⁷ An interview with Iraqi Lieutenant General Al-Hamdani of the Iraqi Republican Guard revealed that his arguments for moving more forces south to defend Baghdad were dismissed because Saddam was convinced that a major coalition attack would

¹¹⁰ Lieutenant Colonel Allen Hansen, CENTCOM Electronic Warfare Officer, in Andrew Koch, "Information Warfare Tools Rolled Out in Iraq," *Jane's Defence Weekly*, August 6, 2003.

¹¹¹ Brigadier General commanding Baghdad's missile air defenses, as quoted in Robert Fisk, "Ruling the Airwaves—How America Demoralised Iraq's Army," *The Independent*, May 27, 2003.

¹¹² Andrew Koch, "Information Warfare Tools Rolled Out in Iraq."

¹¹³ Thom Shanker, "Regime Thought War Unlikely."

¹¹⁴ Franks, p. 429.

¹¹⁵ Woodward, pp. 83–84.

¹¹⁶ Joseph Galloway, "General Tommy Franks Discusses Conducting the War in Iraq," Knight Ridder Newspapers, June 19, 2003.

¹¹⁷ Franks, pp. 406–407, 434–436.

come from the north and west of Baghdad.¹¹⁸ Interrogations with captured Iraqi leaders also support the claim that Saddam believed the attack would come from Jordan.¹¹⁹

The information operations plan also included frequency herding to assist in intelligence gathering. This process involved making some means of communications unusable to force the Iraqis to use more exploitable means of communication. The destruction of fiber optic communication infrastructure and electronic warfare operations were part of this effort.¹²⁰

Support to the Major Combat Operations

Leaflet drops and radio broadcasts continued once major combat began. The radio broadcasts covered more of Iraq as the environment became more permissive. In addition to the leaflet drops from high-flying Air Force and Navy aircraft, leaflets were dropped from helicopters organic to the ground units. This method, known as “static line leaflet drops,”¹²¹ provided the ground commander flexibility in the PSYOP campaign. The missions were not resource intensive, but they did require a permissive environment because of the low altitudes at which these aircraft had to fly.¹²²

Just before the start of major combat operations, PSYOP messages shifted from encouraging Iraqis to desert to giving them instructions on how to capitulate as a unit.¹²³ As mentioned in Chapter Six, it was a long-standing belief among planners that the Iraqis had no stomach for a fight with the coalition: They were militarily weak, poorly trained, and unwilling to fight for an oppressive regime. However, once combat operations began, it quickly became apparent that Iraqis were unable to comply with what were, for them, complex capitulation instructions (as depicted in the left-hand message in Figure 7.11). So PSYOP messages again encouraged Iraqis to desert with the message “go home and be with your family.”¹²⁴ Rather than capitulating, Iraqis deserted in large numbers during major combat operations.¹²⁵

¹¹⁸ *Frontline* interview with Lieutenant General Al-Hamdani.

¹¹⁹ Shanker, “Regime Thought War Unlikely.”

¹²⁰ Koch.

¹²¹ The process involves dropping boxes filled with leaflets on static lines from low-flying aircraft.

¹²² Bergeron.

¹²³ Lieutenant Colonel Christopher Stafford, former commander 9th Information Warfare Flight, “Information Warfare Brief,” September 24, 2005; Henry S. Kenyon, “Unconventional Information Operations Shorten Wars,” *Signal*, August 2003.

¹²⁴ PSYOP leaflet IZD-57. As of October 25, 2004:
<http://www.iwar.org.uk/psyops/resources/iraq/izd-057.jpg>

¹²⁵ “Capitulation,” as used by the military, generally meant surrendering as an intact unit to avoid becoming prisoners of war. The sensors discussed earlier were then used to search for signs of enemy capitulation. Fully 600 capitulation missions were planned for the sensors deployed in OIF.

Figure 7.11
Coalition Capitulation and Desertion Messages



RAND MG641-7.11

The desertion of Iraqi forces has been touted by the IO community as a PSYOP success. Others have argued that bombing, rather than PSYOP efforts, explains the desertions. Captured Iraqi leaders have claimed that the leaflet messages did not persuade people to desert; rather, the coalition's ability to pinpoint their positions with leaflets sent a clear message that next time it could be a bomb.¹²⁶ On the other hand, PSYOP may have reinforced the messages of U.S. military superiority and the inevitability of defeat. Current evidence does not conclusively support PSYOP as the decisive factor in the desertions.

In addition to radio broadcasts and leaflets, tactical PSYOP teams (TPTs) supported V Corps and I MEF along the entire route of march.¹²⁷ Teams also supported the United Kingdom's division and Australian forces. TPTs, three-man teams equipped with a loudspeaker, provided the commanders with a way of communicating directly with the civilian population. These teams were universally used to broadcast civilian noninterference messages.¹²⁸ Loudspeakers were also used to communicate with and deceive the enemy. TPTs coordinated other PSYOP missions such as distributing hand-

¹²⁶Shanker, "Regime Thought War Unlikely."

¹²⁷Fontenot, Degen, and Tohn, p. 279.

¹²⁸Interviews with personnel of the 4th PSYOP Group, March 4, 2004. Also see 1st Marine Division, *After Action Report*, Chapter 4, p. 26.

bills and posters or requesting support from higher headquarters. In some cases, they also integrated their operations with kinetic operations to achieve maximum effect.¹²⁹

Communications with the enemy included threats, deception, and challenges to their masculinity.¹³⁰ The results included revealing enemy positions, surrenders, and desertions. For example, on March 25, a TPT used loudspeakers to broadcast a surrender message to paramilitary forces fighting marines in An Nasiriyah. The message informed the fighters that bombs would be dropped in their positions if they did not surrender. The fighters began following the surrender instructions within ten minutes of the loudspeaker announcement.¹³¹

Tactical communications net intrusions continued throughout major combat operations. Electronic warfare expanded from the restricted areas and target sets during Phase I operations to cover the entire battlefield in support of air and ground operations. Military deception activities remained mostly at the tactical level. Tactical teams used their loudspeakers to deceive small groups of Fedayeen about the direction or nature of an attack. In other cases, they used their loudspeakers to force the Fedayeen to reveal their positions. Major General (USAF) Victor Renuart, CENTCOM's Director of Operations, said that since there were very few computers with Internet access in Iraq, computer network operations constituted only a small part of all IO activities.¹³²

Did IO Have an Effect?

A preponderance of anecdotal evidence suggests that tactical PSYOP teams were effective, despite the challenges the teams faced in getting supplies and support. At the tactical level, PSYOP seek a temporary change in behavior or perceptions that will cause the enemy to behave in a way that is consistent with the commander's goals. Interviews and after action reports indicated that both TPT members and ground commanders saw tactical-level PSYOP as a success. Interviews have suggested that teams who integrated with their units early on were used more frequently by their units and also provided better support by tailoring PSYOP products for the unit's route of march. Teams repeatedly rose above equipment and PSYOP product shortfalls by coming up with improvised alternatives.

Some opportunities for information operations to play a role during major combat operations were missed as well. For example, IO was not fully used against all campaign objectives. The PSYOP campaign focused primarily on Iraqi forces. When it did communicate with civilians, during and leading up to major combat operations, the main message to the Iraqi people seemed to be "stay out of the way." In fact, the only

¹²⁹Interviews with personnel of the 4th PSYOP Group, March 4, 2004.

¹³⁰1st Marine Division, *After Action Report*, Chapter 5, p. 46. Interviews with personnel of the 4th PSYOP Group, March 4, 2004.

¹³¹Fontenot, Degen, and Tohn, pp. 279–280.

¹³²Koch.

goal of the PSYOP campaign for the civilian population during major combat operations was to reduce the threat to the Iraqi people.¹³³

While this may have been the only thing needed during combat operations, the coalition's PSYOP campaign during this period could have been better geared to creating conditions for a transition to a representative self-government, another of the campaign's goals.¹³⁴ For example, officers on the ground during major combat operations indicated that as they liberated areas of Iraq, there was no IO plan in place to communicate with or build the support of the civilian population. IO personnel at CENTCOM observed that there was not an IO plan in place for the liberation of Baghdad. Rather, tactical teams supporting I MEF developed ad hoc efforts when, for example, a Marine Corps officer realized the significance of Saddam's statue falling in Al-Firdos Square.¹³⁵

Developing Measures

To date, the approach to assessing the effects of information operations has not been very scientific. Part of the problem is that the IO community lacks user-friendly, robust, and timely measures of effectiveness (MOEs). This makes it difficult to determine what contribution IO made to the campaign in Iraq even in hindsight.

The lack of agreed MOEs has led the IO community to resort to measuring inputs. Although input measures only assess performance of the IO process, they are often reported as a surrogate for the effects of IO on combat effectiveness. Some examples are: the number of leaflets dropped, the number of hours of broadcasts, and the number of electronic attack sorties. Although important, these metrics do not measure the degree to which information operations contributed to (or detracted from) combat operations.

In cases where lessons learned reports attempt to gauge outcomes, they repeatedly use anecdotal success stories as measures of effectiveness, thus leading to incomplete assessments. For example, some in the IO community have cited the preservation of the oil fields and other critical infrastructure as proving the effectiveness of PSYOP, but there may have been other contributing or decisive factors. The accounts cite the fact that most of the wells were preserved and, in some cases, that workers rigged the wells to limit the destruction while still appearing to follow orders. However, interrogation of Iraqi leaders revealed that Saddam believed he could weather the U.S. invasion,¹³⁶ so it is possible that the order was never given to destroy all of the wells. Other reports have used EPW interrogations to evaluate the effectiveness of PSYOP after the fact.

¹³³Bergeron.

¹³⁴U.S. CENTCOM, "Briefing with CENTCOM Commander General Tommy Franks: Military Operations in Iraq," News Release, March 22, 2003.

¹³⁵Fontenot, Degen, and Tohn, Chapter 6.

¹³⁶Shanker, "Regime Thought War Unlikely."

While this information can be useful, it must be used carefully. EPWs may not always be a credible source of information because they are, by definition, under duress.

Developing measures of effectiveness for information operations is not a trivial task. Measuring PSYOP effectiveness is especially challenging because often the goal is inaction on the part of the target audience, e.g., “do not use WMD,” or “do not destroy the oil wells.” Although PSYOP messages discouraged the use of WMD, the lack of WMD use is not itself proof that the PSYOP campaign was effective. The fact that none were found in Iraq is a more convincing argument.

Reasonable measures that allow commanders to assess the effectiveness of information operations on combat outcomes should consist of a mix of quantitative and qualitative techniques that link the performance of information operations as a system to combat outcomes. Once measures are established, adequate collection assets must be devoted to collecting the data required to apply them. Finally, ground commanders need to be informed of the successes and failures of IO so they can use the information to adjust future plans.

Moving IO into the Mainstream

To become a more integral part of combat operations, IO must continue to mature in some areas. First, the IO community must demonstrate its contributions to external audiences. In OIF, Army and Marine Corps commanders complained that they received little to no feedback on the effects of IO during major combat operations. This contributed to a lack of confidence in IO as a tool that could be used against the enemy. Part of the reason for this lack of feedback was that the IO community lacks objective means to assess the effectiveness of its operations on combat outcomes and thereby is unable to communicate success to ground commanders. Recent efforts to address the challenge of creating acceptable measures of effectiveness indicate that the services are beginning to recognize the importance of measuring IO effectiveness.¹³⁷

Second, integration across IO capabilities and with traditional fires must go further than it did in OIF for IO to reach its full potential. Although the net intrusions and the efforts to combine PSYOP with computer network methods indicate that IO is better integrated than in the past, these are only initial steps to reaching the vision described in policy documents. Organizational and procedural barriers, a lengthy PSYOP approval process, and the continued tension between PSYOP and the rest of the IO community hindered true synchronization and integration in OIF. Though we refer to an “IO community,” it really consisted of a complex organization of loosely

¹³⁷See Eric V. Larson, Richard E. Darilek, Dalia Dassa Kaye, Forrest E. Morgan, Brian Nichiporuk, Diana Dunham-Scott, Cathryn Quantic Thurston, and Kristin J. Leuschner, *Understanding Commanders' Information Needs for Influence Operations*, Santa Monica, CA: RAND Corporation, MG-656-A, 2009, and Eric V. Larson, Richard E. Darilek, Daniel Gibran, Brian Nichiporuk, Amy Richardson, Lowell H. Schwartz, and Cathryn Quantic Thurston, *Foundations of Effective Influence Operations: A Framework for Enhancing Army Capabilities*, Santa Monica, CA: RAND Corporation, 2009.

affiliated groups working on IO for OIF. These groups had to overcome organizational impediments to better integrate and demonstrate effects to skeptics.

The target nomination process complicated integrating IO with traditional fires in OIF. Target nominations are requests from subordinate commands that certain targets be struck by air assets using either lethal or nonlethal means. Approved targets are added to the air tasking order (ATO), the plan for how air assets will be allocated on a given day. Although the IO targets eventually end up on the same ATO as traditional fires, there are differences in the way these targets get to the ATO that make it difficult to nominate them together. Some objectives may call for the application of both lethal and nonlethal means. However, since the nomination process for commands to request IO versus traditional fires support followed different channels in OIF, any attempt to apply them against the same targets was complicated.

Third, if IO is to be a mainstream part of combat operations, it must have better intelligence to support it than it did in OIF. Electronic warfare (EW) and computer network operations require very specific technical information, such as frequencies or email addresses, to be effective. PSYOP and deception are highly sensitive to the quality of cultural understanding and the assessment of competing information sources. Therefore, unlike in OIF, IO officers need to have a close relationship with their unit's intelligence officers and have more intelligence assets devoted to their intelligence needs.

Fourth, commanders and IO officers need to be better educated as to the capabilities available to them than they were in OIF. Interviews have suggested that the highly sensitive nature of the results of some IO capabilities prevented the people who needed the assets the most from knowing what was available.

Finally, to be relevant, IO must be better able than it was in OIF to adapt to unexpected changes on the battlefield. Tactical PSYOP teams demonstrated an ability to adapt to changing circumstances. However, the IO community should be able to do that at the campaign level. For example, the IO community did not react quickly to the unexpected emergence of the Fedayeen: lengthy delays in PSYOP product approval prevented coalition messages from getting out as situations emerged. The coalition was also unable to dominate the information environment at the operational level. The regime's systems were more resistant to attacks than the coalition expected.¹³⁸ Therefore, the Iraqi information minister Mohammed Said Sahaf (commonly known as Baghdad Bob or Comical Ali) continued to get the regime's messages to Iraqi forces and civilians, possibly demonstrating the resilience of the regime.

Military campaigns from Kosovo to Afghanistan, as well as Iraq, accentuate the need to minimize noncombatant casualties, to preserve infrastructure, and to convince enemy populations that their interests have been taken into account. This requires winning civilian cooperation through the expanded use of the nonlethal aspects of

¹³⁸Shanker, "Regime Thought War Unlikely."

information operations. IO, therefore, needs to become more mainstream and trusted by commanders. In its OIF form, IO was not sufficient to meet these needs: Its capabilities, organization, and integration must mature significantly to meet the Defense Department's vision. In the case of PSYOP, maturing implies looking beyond leaflet messages and short radio broadcasts to more sophisticated programming and message development. However, IO's high-visibility role in OIF planning tends to suggest that it may have gained some of the high-level advocacy it needs to meet that vision. The new tactics used in Iraq tend to indicate that IO did adapt to better meet the needs of commanders.

Media Coverage

The public affairs efforts of the U.S. military in OIF consisted of two distinct parts. The most visible, and the one that received the greatest amount of attention, was the decision to embed reporters directly into air, naval, and ground units in the midst of combat operations. Embedded reporters, with very few exceptions, were able to report immediately on combat operations during the 21-day march to Baghdad with few constraints from the military. This was by design. The decision to embed reporters was made to provide "the factual story—good or bad—before others seed the media with disinformation and distortions."¹³⁹

The second part of the military's public affairs effort in OIF was the daily briefings that occurred in both the Pentagon and at the Coalition Information Center in Doha, Qatar. Unlike the embedded media, these forums were opportunities for CENTCOM to communicate directly with a worldwide audience through briefings and answers to questions from media organizations stationed in Doha. While the main briefer, Brigadier General Vincent Brooks, had the title of Deputy Operations Officer, there is little doubt he was performing the public affairs mission, namely, to inform the American people and foreign audiences about the operations of coalition forces in Iraq.

There were stark differences between the two elements of public affairs in OIF. The embedded media portion was designed far in advance of the operation and was part of the planning process for the entire operation. It had high-level approval and was thoroughly integrated into the warplan. As for the daily briefings, planning for the Coalition Information Center started extremely late in the war planning process, and it was not well coordinated with other U.S. government departments and agencies. There was also confusion about the purpose of the Coalition Information Center daily briefings and the audience to be addressed. The briefings were similar in form to those

¹³⁹U.S. Secretary of Defense, Office of the Assistant Secretary of Defense, Public Affairs, "Public Affairs Guidance (PAG) on Embedding Media During Possible Future Operations/Deployments in the U.S. Central Commands (CENTCOM) Area of Responsibility," Cable to various military and government offices, February 10, 2003, sent 1900Z.

used in DESERT STORM in 1991, despite radical changes over the last ten years in the structure of the global media.

We explore these two elements of public affairs from four perspectives. First we address the mission and objectives of public affairs as set forth in joint doctrine and how the warplan for OIF sought to meet these objectives. This includes what joint doctrine said at the time about the relationship between public diplomacy, PSYOP, and public affairs. Second, we focus on the planning for and operation of the two elements of public affairs during major combat operations. Third, we provide a brief evaluation of how well public affairs worked during OIF. And finally, we offer some conclusions and recommendations for future public affairs operations.

The Warplan

The warplan for OIF outlined the role of public affairs in support of military operations to replace the Iraqi regime. One of the assumptions was that the Iraqi media and other sources would make every effort to engage in disinformation, propaganda, and fictionalized reporting, in an attempt to target world opinion against or disrupt coalition military operations. As part of its mission, public affairs was charged with counteracting these efforts by providing access to unclassified, timely, and accurate accounts of operations. This charge was in addition to the public affairs mission of informing the American and international public about, and thereby gaining and maintaining support for, military operations. This fit closely with joint doctrine in force during OIF, which stated that the mission of public affairs was to “expedite the flow of accurate and timely information about the activities of U.S. joint forces to the public and international audiences.”¹⁴⁰ That mission in OIF, as with other operations, had to be balanced against the need to maintain operational security and to respect the privacy of the members of the armed forces.

Responsibility for public affairs before and during OIF was divided between the Office of the Assistant Secretary of Defense for Public Affairs (OASD(PA)) and CENTCOM/PA. OASD(PA) provided overall public affairs guidance, such as the rules and regulations of the embedded media program. OASD(PA) also coordinated with the State Department on media access to coalition forces. CENTCOM/PA was responsible for all media relations programs within its area of responsibility, including the supervision of coalition public information centers. The warplan indicated that media activities were to be coordinated with the U.S. embassy in the host country where military operations were taking place.

As part of its responsibilities, CENTCOM/PA was to provide in-theater media briefings. A flag-level officer with sufficient operational knowledge and authority was to conduct “daily, comprehensive, and unclassified operations briefings for news media

¹⁴⁰U.S Department of Defense, Joint Publication 3-61, *Doctrine for Public Affairs in Joint Operations*, Washington, D.C.: GPO, May 14, 1997.

representatives at an appropriate operational location.” These briefings and other media coverage were to be supplemented by CENTCOM J-3 (operations) combat camera footage shot on the battlefield.

Another key mission of public affairs outlined in the warplan was to help coordinate the dissemination of information if direct news media coverage was not possible. This was to be accomplished by working with combatant commanders to rapidly evaluate and release pertinent information to the media. Key items identified for release were combat camera footage, bomb damage assessment, and gun camera video. It was expected that during certain phases of the operation, imagery from military sources would be the only means of telling the operational story.

The relationship between public affairs, PSYOP, and public diplomacy was explicitly specified in joint doctrine, where each of these functions was treated as a separate aspect of the “informational instrument of national security strategy.”¹⁴¹ While both public diplomacy and PSYOP are used to influence international audiences in favor of U.S. policies, public affairs is focused doctrinally on the timely and accurate flow of information. Public affairs is not supposed to focus on directing or manipulating public actions or opinion. By law, public affairs and PSYOP were to be separate and distinct.¹⁴²

However, joint doctrine noted that “it is critically important that PA, public diplomacy, and PSYOP coordinate among each other in order to maintain credibility with their respective audiences.” To this end, joint doctrine said there must be “coordination early during the planning process” and there should be a “continual exchange of information during execution.” Although PA and PSYOP messages may be different, it is vital that they do not contradict one another or the credibility of both will be lost. The warplan provided similar instruction to CENTCOM/PA; it was directed to closely coordinate with the CENTCOM Space and Information Operations Element (SIOE) to “eliminate the possibility of releasing conflicting military information.”¹⁴³ The objective was to avoid eroding the credibility of PA.

¹⁴¹ U.S. Department of Defense, Joint Publication 1, *Joint Warfare of the Armed Forces*, Washington, D.C.: GPO, November 14, 2000.

¹⁴² 22 U.S.C. Sec. 1461 (1948). The Smith-Mundt Act prohibited the United States Information Agency (applied to the Department of State since 1998) from disseminating information “within the United States, its territories, or possessions.” Smith-Mundt was amended by the Foreign Relations Authorization Act of 1972, which banned domestic dissemination of information prepared for foreign audiences “about the United States, its people, and its policies.” The Zorinsky Amendment of 1985 (Sec. 1461-1a) added the prohibition that “no funds be authorized to be appropriated to the United States Information Agency shall be used to influence public opinion in the United States, and no program material prepared by the United States Information Agency shall be distributed within the United States.”

¹⁴³ The SIOE had responsibility for the IO campaign. Hence, coordination of messages from the public affairs and the IO community was to ensure consistency.

Planning

By the summer of 2002, the media was filled with stories about potential warplans to invade Iraq and remove Saddam Hussein from power.¹⁴⁴ During this period, news organizations approached OASD(PA) to discuss how the potential war should be covered. The media wanted to cover the war from the front lines, alongside the troops in the field. Leaders within the Defense Department were also thinking about how the media might report on the war and how their presence on the battlefield might be useful to counteract Iraqi propaganda.

Victoria Clarke, the Assistant Secretary of Defense for PA, organized a multiservice Iraq public affairs planning cell in early October to explore possible approaches for media coverage of a potential war in Iraq. Among the recommendations of this panel was support for the notion of “embedding reporters” with front line combat groups. DoD defined a “media embed” as a “media representative remaining with a unit on an extended basis—perhaps a period of weeks or even months.”¹⁴⁵ Clarke presented this recommendation to Secretary of Defense Rumsfeld, who subsequently approved the plan.

Rumsfeld demonstrated his approval by appearing at an October 30, 2002, meeting with media bureau chiefs on how public affairs was planning to assist the media in covering any potential military operations in Iraq. In his response to questions, Rumsfeld indicated that not only was media coverage of military operations one of DoD’s responsibilities, as a government institution operating in a free society, but also that press coverage particularly by embedded reporters on the ground, was militarily useful. Rumsfeld noted that the Iraqis had, in the past, demonstrated a great deal of skill in news management by co-locating military activities with civilian infrastructure. In order to combat such skills, Rumsfeld said, “in the event that something takes place [a bombing on a civilian site] in Iraq, having people who are honest and professional see these things and be aware of that is useful. So I consider it not just the right thing to do but also a helpful thing.”¹⁴⁶

After media embedding was approved at the highest levels, OASD(PA) took a number of steps to maximize its chances for success. First, a military training program was set up to familiarize reporters with the types of hardships they would face when reporting from the front lines. During the training, reporters slept in bunks, got up at 5:00 in the morning, learned about the dangers presented by nuclear-biological-

¹⁴⁴For example, Paul Richter, “Congress Calling for Clarity on Iraq,” *Los Angeles Times*, July 31, 2002, and Eric Schmitt, “Air Power Alone Can’t Defeat Iraq, Rumsfeld Asserts,” *New York Times*, July 31, 2002.

¹⁴⁵Message: SECDEF WASHINGTON DC//OASD-PA// to SECDEF WASHINGTON DC//CHAIRS//, SUBJ: Public Affairs Guidance on Embedding Media, 101900Z FEB 03.

¹⁴⁶U.S. Department of Defense, “ASD PA Clarke Meeting with Bureau Chiefs,” news transcript, October 30, 2002.

chemical attacks, and marched with military packs and Kevlar helmets.¹⁴⁷ Hundreds of reporters signed up and completed their training between October 2002 and February 2003.

Second, a careful planning process was undertaken by OASD(PA) to determine appropriate units in which to embed reporters. The process was centralized through OASD(PA) with help from Jim Wilkinson, a specialist in public affairs from the White House, who was assigned to CENTCOM to work on public affairs. OASD(PA) established a central point of contact with each media organization, allowing them to determine the breadth of coverage they were hoping for: OASD(PA) then determined how many slots each media organization was to receive and which units they could embed with. For example, the *Washington Post* had about two dozen reporters who were sent to the war zone. Among those were ten reporters who were embedded with Army, Marine Corps, and Air Force units. In total about 400 reporters were embedded in the Army, 18 in the Air Force, about 150 in the Marine Corps, and 141 in the Navy.¹⁴⁸ Table 7.4 presents a sample of the media outlets represented and the units to which their embedded reporters were assigned.¹⁴⁹

Third, OASD(PA) worked with CENTCOM commanders to ensure that media organizations had the equipment needed both to report from the field and to maintain the reporters' safety. Commanders provided access to military transportation, food, assistance with communications, and nuclear, chemical, and biological protection gear. Media officials were responsible for their own personal safety gear and clothing. They were not allowed to carry personal firearms. Reporters also had to agree to certain ground rules when reporting. These rules required that "all interviews with service members be on the record" and that reporters refrain from discussing specific numbers of troops and "information regarding future military operations."¹⁵⁰

The official ground rules for embedding reporters in OIF were sent out by the OASD(PA) on February 10, 2003. This message provided guidance and established the rules governing the conduct of the media and of their host units. It explicitly states that "The Department of Defense policy on media coverage of future military operations is that media will have long term, minimally restrictive access to U.S. air, ground, and naval forces through embedding."¹⁵¹ It goes on to stress that

¹⁴⁷ Brendan McLane, "Reporting from the Sandstorm: An Appraisal of Embedding," *Parameters*, Vol. 34, No. 1, 2004.

¹⁴⁸ Christopher Cooper and David Cloud, "Branches of U.S. Military Fight over Air Time and Credit: A Final Battle over Budgets?" *Wall Street Journal*, March 26, 2003.

¹⁴⁹ The sample was gathered from various media sources. No official government record of these statistics could be located.

¹⁵⁰ U.S. Secretary of Defense, Office of the Assistant Secretary of Defense.

¹⁵¹ U.S. Secretary of Defense, Office of the Assistant Secretary of Defense.

Table 7.4
A Sample of Media Organizations Embedded

Organization	Number Embedded	Army Units with Embedded Reporters
Major newspapers		
<i>New York Times</i>	15	101st Airborne, 3rd Infantry, 4th Infantry
<i>Washington Post</i>	10	3rd Infantry, 82nd Airborne
<i>Boston Globe</i>	4	3rd Infantry
<i>Atlanta Constitution</i>	5	
<i>Newsday</i>	6	
<i>Dallas Morning News</i>	4	3rd Infantry
<i>Wall Street Journal</i>	7	
<i>Los Angeles Times</i>	6	3rd Infantry, 2nd Brigade Combat Team
<i>USA Today</i>	7	101st Airborne, 3rd Infantry, V Corps HQ
Networks		
ABC	26	3rd Infantry HQ, 101st Airborne,
NBC	26	3rd Infantry Division
CBS	26	3rd Infantry, 1st Brigade Combat Team
CNN	26	101st Airborne, 3rd Infantry
Fox	26	3rd Infantry
Foreign Media		
British media total	128	3rd Infantry (BBC)
Spain, El Mundo	1	3rd Infantry
Qatar, Al Jazeera	1	

SOURCE: Information obtained from the media organizations sampled.

Our ultimate strategic success in bringing peace and security to this region will come in our long term commitment to supporting our democratic ideals. We need to tell the factual story—good or bad—before others seed the media with disinformation and distortions. We must organize for and facilitate access to national and international media in our forces, including forces engaged in ground operations.¹⁵²

This guidance continued by providing that media “will be given access to operational combat missions, including mission preparation and debriefing, whenever possible.” Additional ground rules contained in the guidance explicitly “recognize the right of the media to cover military operations and are in no way intended to prevent the release of derogatory, embarrassing, negative, or uncomplimentary information.”¹⁵³

The degree to which this directive insisted on full and complete media access to U.S. forces is remarkable when compared with the recent history of the relationship

¹⁵² U.S. Secretary of Defense, Office of the Assistant Secretary of Defense.

¹⁵³ U.S. Secretary of Defense, Office of the Assistant Secretary of Defense.

between the U.S. military and the media. For example, the Department of Defense in 1991 had a very different media policy for DESERT SHIELD and DESERT STORM, although, as indicated in Table 7.5, a similar number of reporters covered the operation. In the Gulf War, all interviews with U.S. troops had to be conducted in the presence of a CENTCOM public affairs official. Media products were obliged to undergo a security review by public affairs officers before they could be broadcast or published. Before the operation began, CENTCOM determined that open coverage of ground combat operations, similar to that of OIF, was impractical. CENTCOM offered the following explanation for this policy: “Given the size and distances involved, the probable speed of advance of U.S. forces, the potential for Iraqi use of chemical weapons, and the sheer violence of a large scale armored battle, open coverage of ground combat operations is impractical, at least during its initial phase.”¹⁵⁴

Both in DESERT STORM and in IRAQI FREEDOM, CENTCOM conducted extensive briefings in the theater of operations. In DESERT STORM, the command provided 98 briefings, 53 on the record and 45 on background.¹⁵⁵ This was complemented by extensive briefings at the Pentagon every day of the war. These briefings were not accidental; Secretary of Defense Dick Cheney and CENTCOM commander General Norman Schwarzkopf sought “to manage the information flow” about what the United States military was doing.¹⁵⁶ This was accomplished by feeding the media information about what was going on through both the Pentagon and the CENTCOM briefings. Cheney believed that getting information to the public was “extraordinarily important” and he “did not have a lot of confidence” that he could leave that up to the press.¹⁵⁷

Table 7.5
Number of Reporters in Recent Operations

Operation	DESERT STORM	Somalia	Bosnia	IRAQI FREEDOM
Estimated number of reporters	1,600	600	N.A.	2,200
Pool/embedded	186	0	33	660

SOURCE: Christopher Paul and James J. Kim, *Reporters on the Battlefield: The Embedded Press System in Historical Context*, Santa Monica, CA: RAND Corporation, MG-200-RC, 2004.

¹⁵⁴U.S. Department of Defense, *Conduct of the Persian Gulf War, Final Report to Congress*, Appendix S, Washington: DoD, 1992, pp. 743–748.

¹⁵⁵U.S. Department of Defense, 1992.

¹⁵⁶Quote from a 1995 interview with Dick Cheney in Frank Aukofer and William Lawrence, *America’s Team: The Odd Couple—A Report on the Relationship Between the Media and the Military*, Nashville, TN: Freedom Forum First Amendment Center, 1995.

¹⁵⁷Aukofer and Lawrence.

Another important factor in Schwarzkopf's media policy was his deep concern about operational security. The coalition's military plan depended upon strategic surprise, and Schwarzkopf was worried the media would give away the "left hook" flanking maneuver. Peter Williams, the Assistant Secretary of Defense for PA in 1991, asked Schwarzkopf if CENTCOM could put reporters out with the units and let them remain with the units as long as they wanted to. According to Williams, Schwarzkopf rejected this proposal because of "his fear that if you let reporters stay with the units when the flanking maneuver began, they'd be filing datelines, and you could just kind of watch them move further west and north, and he was afraid that would telegraph the left hook."¹⁵⁸

Despite press complaints about the restrictions placed on them by the Pentagon, the public was generally satisfied with the coverage they received during DESERT STORM. Gallup polls conducted during the war indicted that 79 percent of the public rated media coverage as excellent or good. According to media observers, this can be attributed largely to the increasing media savvy of military leaders, particularly General Schwarzkopf.¹⁵⁹ His briefings plus spectacular combat footage made a powerful impression on the American public.

Operations

Although the format of CENTCOM's briefings in OIF was similar to the one used in DESERT STORM, their content and purpose were quite different. In terms of planning, interviews with public affairs officers involved in OIF indicate a lack of emphasis on the CENTCOM briefings given in Doha, Qatar. Interviews with officials in the State Department revealed a lack of coordination between State and the Department of Defense over the public affairs/public diplomacy strategy before and during the war.¹⁶⁰ Before the war, official government policy vacillated between diplomatic efforts to avoid war and preparations for it. Officials at the National Security Council noted a reticence by regional as well as European-based American embassies to believe in the inevitability of the war; thus there was an aversion to engaging in public diplomacy or public affairs activities that would help prepare for war.¹⁶¹ A symptom of this dichotomy was the absence of any State Department officials in the groups that established the Coalition Information Center in Doha, Qatar, in November 2002.

¹⁵⁸ Aukofer and Lawrence.

¹⁵⁹ Lieutenant Colonel (USAF) Douglas J. Goebel, *Military-Media Relations: The Future Media Environment and Its Influence on Military Operations*, Maxwell Air Force Base, AL: Air War College and Air University, 1997, pp. 18–22.

¹⁶⁰ Interview with State Department officials, March 30, 2003. See James Fallows, "Blind into Baghdad," *Atlantic Monthly*, January/February 2004, for a detailed description of the dysfunctional relationship between the State and Defense Departments before and during the war.

¹⁶¹ Interview with National Security Council staff, March and April 2004.

According to interviews of Brigadier General Brooks, the lead briefer during OIF, the CENTCOM briefings were part of the daily “battle rhythm” of the conflict.¹⁶² Brooks said the briefings were supposed to provide an operational perspective on the war, with the intended audience being the general public in the United States, the Arab world, and Iraq, not the reporters working in Doha. In his daily briefings, therefore, Brooks chose to highlight key themes, which he believed would support the general thrust of ongoing information operations, and he focused on such themes as the multinational forces in the field, the care and precision taken in the bombing campaign to avoid collateral damage to civilian targets, the continuing progress and inevitable victory of coalition forces, and the liberation of Iraq from Saddam Hussein’s regime.

The CENTCOM briefings were highly criticized by the journalists working in Doha and their editors in the United States. Four specific charges were leveled throughout the campaign. First, unlike the briefings given by General Schwarzkopf, the OIF briefings did not provide an overview of the operation. They failed to place the daily military actions, taking place across Iraq, in the context of the overall war strategy. Brooks specifically stated that this was not the purpose of his briefings.¹⁶³ The effect of not providing an overview was that editors were unsure how to make hard journalistic decisions about the importance of various stories; they lacked a solid understanding of how these individual stories fit into the general story of how the war was progressing. The inability of the media to present an accurate overall picture was highlighted during the war’s second week, when media coverage was filled with negative stories about the progress of the war.¹⁶⁴ From a military viewpoint, the operation was proceeding according to plan, although there had been some setbacks during the second week. Less than ten days after the start of the negative media coverage, the major combat operations phase was brought to a successful conclusion with the coalition suffering only minimal casualties. This disconnect between military reality and press coverage might have diminished if the press had been provided with a coherent “big picture” briefing that highlighted the substantial progress being made by coalition air and ground forces during this period.

The second criticism of CENTCOM briefings was the lack of any new information they provided. For example, on March 31, the BBC asked Brooks about the level of damage that had been inflicted on Republican Guard units outside of Baghdad. The journalist indicated he was hoping Brooks would use intelligence reports he had seen to provide an overview of the damage inflicted on these units. Brooks instead provided

¹⁶²Army War College, “Reporters on the Ground: The Military and the Media’s Joint Experience During Operation Iraqi Freedom,” workshop transcript, September 3–5, 2003.

¹⁶³Army War College.

¹⁶⁴For example, Ellen Knickmeyer, “Sandstorm Brings Forces to Grinding Halt” *Washington Times*, March 25, 2003; Vernon Loeb and Thomas E. Ricks, “Questions Raised About Invasion Force: Some Ex-Gulf War Commanders Say U.S. Needs More Troops, Another Armored Division,” *Washington Post*, March 25, 2003.

a vague answer saying “we are targeting them . . . and we are destroying them.” These kinds of answers led to a great deal of frustration among the journalists in Doha, with many saying the briefings were purely propaganda instruments with no news value.¹⁶⁵ The lack of news provided to journalists in Doha was in marked contrast to the volume of information provided by their embedded colleagues. During the briefings, CENTCOM seemed unprepared to deal with the information provided by the embedded reporters and was very cautious in confirming or denying reports from the field.

A third criticism leveled at the briefings was that the presenter, mainly Brigadier General Brooks, was a lower-level staff officer and not a senior official such as CENTCOM commander General Tommy Franks. This criticism formed part of a now famous exchange on March 27 between a reporter for *New Yorker* magazine, Michael Wolff, and Brigadier General Brooks:

Q: I’m Michael Wolf [sic] from *New Yorker* magazine. I mean no disrespect by this question, but I want to ask about the valued proposition of these briefings. We’re no longer being briefed by [the] senior-most officers. To the extent that we get information, it’s largely information already released by the Pentagon. You may know that ABC has sent its senior correspondent home.

So I guess my question is, why should we stay? What’s the value to us for what we learn at this million-dollar press center? (Applause.)

Brooks: I’ve gotten applause already. That’s wonderful. I appreciate that.

First, I would say it’s your choice. We want to provide information that’s truthful from the operational headquarters that is running this war. There are a number of places where information is available, not the least of which would be the embedded media. And they tell a very important story. The Pentagon has a set of information they provide as well. If you’re looking for the entire mosaic, then you should be here.

I think some of you may have been, based on the questions yesterday, looking for very, very precise information about the operations. And we’ll give you that as we can. But we should never forget, the more we tell you, if we’re precise about the front line trace and where units are operating, exactly what our strength is, you’re not the only one being informed. And that’s the most important (business?).

Q: (Inaudible)—but is it possible that we can get General Franks on a more consistent basis?

¹⁶⁵ Bill Katovsky and Timothy Carlson, *Embedded: The Media at War in Iraq, An Oral History*, Guilford, CT: Lyons Press, 2003, p. 39 (interview with media critic Michael Wolff).

Brooks: I'm sorry you feel disappointed. I probably need to get a pay raise here. (Laughter.) General Franks will—he's already shown that he's more than willing to come and talk to you at the right time. But he's fighting a war right now. And he has me to do this for him.¹⁶⁶

While this exchange was handled with humor, it did indicate a feeling among the journalists that they were not getting the full story and that Brooks and other presenters were withholding information because they were not of sufficient rank to provide it.¹⁶⁷ Again, this impression is in marked contrast to the briefings given by General Schwarzkopf, who, as commander in the theater of operations, could provide details about his thinking. Since he was ultimately responsible for operational security, Schwarzkopf acted as his own censor.

The final criticism was the lack of newsworthy footage. The camera footage shown at the briefings was very similar to DESERT STORM's footage, with heavy doses of aerial bombardment and little coverage of the ground battles. With the embedded reporters providing live and graphic coverage of the ground campaign, the briefings seemed slow and old fashioned by comparison. Such was the case despite assurances before the war by Joint Combat Camera that they would be able to provide videos to CENTCOM from the battlefield using satellite uplinks/downloads.¹⁶⁸ The reality during combat operations was that the number of cameras with this capability was limited, and the PSYOP Electronic News Gathering teams designed for this function had none.

The CENTCOM Briefings

Like media sources, official government sources were also critical of CENTCOM's public affairs efforts. They were particularly concerned about CENTCOM's lack of attention to foreign audiences. According to officials at the National Security Council as well as CENTCOM,¹⁶⁹ the CENTCOM briefings were "tailored for an American audience in both content and timing as well as language, missing almost completely what is arguably the most important target audience—the Iraqi people." Officials in the State Department commented that staff with expertise working in the Arab world were unable to contribute to the preparation of CENTCOM briefings. This was because DoD officials denied State Department personnel access to the briefings, at least during the first two weeks of the war.

DoD officials were also criticized for their own lack of knowledge about the Muslim world. This criticism was reinforced by the lack of Arab speakers at the

¹⁶⁶Katovsky and Carlson, p. 39.

¹⁶⁷Katovsky and Carlson, p. 39.

¹⁶⁸Interviews with NSC staff, March and April 2004.

¹⁶⁹Interviews with NSC staff, March and April 2004.

podium, inadequate efforts to engage with the numerous Arab media at the Coalition Information Center in Doha—the home of Al Jazeera—and failure to coordinate with the U.S. Embassy in Qatar. Somewhat better handled was public affairs coordination with coalition partners Great Britain and Australia, whose military officials did present briefings at CENTCOM.

Effectiveness of the Embedded Press System

In their RAND report on the embedded press system, Christopher Paul and James J. Kim present a comprehensive evaluation of the embedded press and place it in the broader context of historical press-military relations.¹⁷⁰ The report concludes that the embedded press system “can be judged as widely successful across a broad range of outcomes.” The authors consider and evaluate outcomes for the military, the press, and the public. Drawing upon their work, other work, and our own research, we do the same here.

- **The military.** The embedded press system produced positive outcomes in three areas. First, the military fulfilled its basic obligations to provide media access to its operations. The press was provided unprecedented access to military operations in real time. Second, the embedded press system produced excellent public relations for the military, showing it to be a professional, disciplined, and highly effective force. Third, the embedded press was able to directly counter the propaganda efforts of the Iraqi regime. On several occasions, members of the embedded press were immediately able to counter the claims of the Iraqi information minister about ongoing combat operations. Perhaps most important militarily, the embedded press system did not significantly compromise operational security. Although approximately six media embeds were dismissed for violations of operational security, none of them enabled Iraqi forces to take advantage of their violations to inflict damage on coalition forces.
- **The press.** The press was also extremely pleased with the embedded media policy. Paul and Kim, in numerous interviews with media figures involved in the operation, found them to be highly satisfied with the coverage they were able to provide. Members of the press were particularly pleased with the unprecedented access they received to the operation, their relative safety in combat versus that of their unembedded colleagues in the field, and the quality of the coverage they were able to provide. Nevertheless, their assignment with units engaged in combat operations was not risk free, as evidenced by the fact that 15 journalists and support staff died between March 22, 2003, and April 15, 2003. Of this number, 2

¹⁷⁰ Christopher Paul and James J. Kim, *Reporters on the Battlefield: The Embedded Press System in Historical Context*, Santa Monica, CA: RAND Corporation, MG-200-RC, 2004.

were embedded and 13 were freelance. Table 7.6 records the press individuals who died in Iraq during this period.¹⁷¹

- **The public.** At the end of major combat operations, public opinion data, a study by the Project for Excellence in Journalism, and news analysis all suggested that Iraqi war coverage was generally of good quality, although there continues to be concern expressed about a loss of objectivity due to close relationships with the troops. Furthermore, the public was also satisfied with the wartime coverage, as Table 7.7 indicates. Polls taken during various stages of the conflict show a perception of the media's coverage that was more favorable than perceptions of other recent military conflicts and on par with opinion about media coverage of DESERT STORM.

Effects on Ground Units

In addition to the more general effects of embedded media, the ground units benefited from the program in very specific ways. From interviews with Army and Marine Corps commanders and troops participating in OIF, as well as from after action reports, the benefits can be divided into three categories: the accuracy of the representation of ground operations in the press; the intelligence value of embedded journalists; and the contribution of embedded journalists to unit morale.

The most direct effect of the embedded reporter program was the accuracy of the representation of ground combat—at least at the tactical level. Embedded reporters were able to disseminate information rapidly and effectively, and this served as a direct counter to propaganda efforts by the Iraqi regime. The media also served as an honest and professional “observer corps,” who could describe events as they actually occurred without their objectives and integrity being constantly scrutinized.

One of the extraordinary things about the embedded media program was the degree of freedom provided to commanders in the field in their relationship with them. Although there were certain ground rules, as laid out by the OASD(PA), it was up to local commanders to decide how they would utilize the media. Commanders decided how much information they would provide regarding: future operations plans; the background of current operations to help clarify what embedded media were experiencing in relation to the mission of the unit; and exactly what pieces of combat the media would see, given where they were placed in a combat unit. Some commanders grew to understand that embedded media were a powerful tool at their disposal, since they had the potential to weaken the hold of Saddam's regime over the Iraqi people.

A prime example of this potential was Colonel David Perkins's use of the press during the first “Thunder Run” on April 5. One of the key pieces of information the

¹⁷¹ “INSI Newsflash: Iraq War Toll Rises Inexorably,” *International News Safety Institute Bulletin*, November 3, 2004.

Table 7.6
Media Deaths from March 22 Through April 15, 2003

Name	Occupation	News Agency	Date Killed	Killed by	Location
Terry Lloyd	Correspondent	ITN (UK)	3/22/03	Enemy action	—
Hussein Osman	Translator	ITN (UK)	3/22/03	Enemy action	—
Paul Moran	Cameraman	ABC (AUS)	3/22/03	Suicide bomber	Sayed Sadiq
Gaby Rado	Correspondent	ITN (UK)	3/31/03	Accident	Sulaymaniyah
Kaveh Golestan	Cameraman	BBC (UK)	4/02/03	Land mine	Northern Iraq
Michael Kelly	Columnist and editor	<i>Atlantic, Washington Post</i>	4/03/03	Accident	Near Baghdad
Kamran Abdurazaq Muhamed	Translator	BBC (UK)	4/06/03	Fratricide	Northern Iraq
David Bloom	Correspondent	NBC	4/06/03	Embolism	Near Baghdad
Christian Liebig	Correspondent	<i>Focus magazine</i>	4/07/03	Iraqi missile	Near Baghdad
Julio Anguita Parrado	Correspondent	<i>Focus magazine</i>	4/07/03	Iraqi missile	Near Baghdad
Tareq Ayyoub	Journalist	Al Jazeera	4/08/03	U.S. fire	Baghdad
Jose Couso	Cameraman	Telecino (Spain)	4/08/03	U.S. fire	Baghdad
Taras Protsyuk	Cameraman	Reuters	4/08/03	U.S. fire	Baghdad
Mario Podesta	Journalist	America TV	4/14/03	Car crash	Near Baghdad
Veronica Cabera	Camerawoman	America TV	4/15/03	Car crash	Near Baghdad

SOURCE: "INSI Newsflash: Iraq War Toll Rises Inexorably," *International News Safety Institute Bulletin*, November 3, 2004.

NOTE: Shaded entries denote embedded journalists.

Table 7.7
U.S. Public Perception of Media Coverage

Conflict	Poll Date	Excellent	Good	Only Fair	Poor	Poller
IRAQI FREEDOM	4/2/03	32%	42%	15%	9%	Pew
	3/29/03	38%	41%	13%	7%	Gallup
	3/22/03	52%	32%	10%	5%	Gallup
Afghanistan	7/8/02	25%	46%	20%	7%	Pew
Kosovo	9/1/99	15%	42%	26%	9%	Pew
DESERT STORM	1/30/91	42%	37%	13%	7%	Gallup

SOURCE: Christopher Paul and James J. Kim, *Reporters on the Battlefield: The Embedded Press System in Historical Context*, Santa Monica, CA: RAND Corporation, MG-200-RC, 2004.

U.S. military wanted to convey to a worldwide audience at the time was that coalition forces were in Baghdad and could go wherever they wanted. This information was an attempt to counteract the media briefings of Mohammed Said Sahaf, the Iraqi information minister, who was contending that the coalition was being defeated and was hundreds of miles south of Baghdad. Colonel Perkins made the key decision first to drive through the center of Baghdad and second to have this documented by a Fox

news crew.¹⁷² A BBC reporter who was working in Baghdad also saw the tanks and reported that fact on the BBC's Arab news service. This event was followed up by the April 7 Thunder Run that demonstrated the U.S. military was in control of Baghdad. The message was reinforced through media coverage of the event by embedded reporters with the 2nd Brigade, which may have contributed to the rapid collapse of the regime.¹⁷³

Another example was a live report given by a reporter from Al Jazeera (the Qatari media outlet) who was embedded with U.S. Marines. The reporter, Amr El-Kakhy, found himself in the port of Umm Qasr as the marines were completing their seizure of the city. At the same time the Iraqi information minister was claiming on Iraqi television that "the port did not fall."¹⁷⁴ After the minister was done speaking, the Al Jazeera anchor turned to El-Kakhy to ask him if he could verify what was being said. El-Kakhy immediately contradicted the claims made by the Iraqi government; he reported that he was standing in the port, which had been taken by coalition forces. The coverage of this incident by Al Jazeera reinforced two key objectives of the coalition's information campaign: It undermined the credibility of the Iraqi regime, and it reinforced the idea that the defeat of the Iraqi regime was inevitable. The credibility of Al Jazeera in the Arab world as a non-Western media organization underscores the great benefit of giving foreign media outlets access to coalition forces and allowing them to directly report on the progress of the war.

Finally, embedded reporters were able to place in context incidents that might negatively affect the war effort. For example, there were a number of incidents involving civilians driving through coalition checkpoints without slowing down. In some cases, coalition forces opened fire and caused casualties among noncombatant civilians. In some of these cases, the coalition units involved had embedded reporters with them who were literally at the scene as the incident occurred, or within minutes afterward. These reporters were able to impart some necessary perspective—they had been with the unit for a period of time, experiencing the same conditions, so they knew whether there had been earlier incidents involving Fedayeen fighters driving through checkpoints and firing on coalition forces; they also knew relevant aspects of the physical condition of the coalition forces involved, such as whether they had gone without sleep for the past 48 hours. As a result, the reporting on these types of incidents tended to be much more balanced and understanding of how coalition forces had responded to the apparently threatening actions of civilians who had driven through checkpoints without stopping.

Embedded reporters also provided additional information, which contributed to the overall situational awareness of the units they worked with. This was a benefit

¹⁷² Army War College.

¹⁷³ See Chapter Four for a detailed discussion of these two events.

¹⁷⁴ Katovsky and Carlson, p. 180.

that was mentioned by several ground commanders during interviews conducted by RAND's study team.¹⁷⁵ Because many reporters were in frequent communication with media outlets, and because these outlets are essentially information-gathering organizations, embedded reporters learned of other engagements that might be of interest to the unit they were with. In many cases, because of problems encountered in disseminating intelligence on the move (see Chapter Four), a unit commander may not have been aware of the reported engagement. Information from the embedded reporter, therefore, provided an external, anecdotal report that the local commander could use to enhance his situational awareness. While anecdotal reporting of this nature could and should not be relied upon for actionable intelligence, it did provide an additional source of information that was valuable to the battlefield commander in its own right.

Many embedded reporters brought their own communications equipment with them and used it to send messages between fielded forces and their families back home. Given that some of these units had not had a mail call in months, the ability to send and receive emails, or make a short phone call home, was a great morale booster. For example, ABC news correspondent Mike Cerre, who was embedded with Second Battalion, Fifth Marines, provided the only way families of that battalion's units could "find out how their guys were doing."¹⁷⁶ The families set up an email chain letter, with each family adding something to the message. Cerre would download the email and parcel out the messages to the troops. The troops in turn would compose a similar message on Cerre's computer, and he would send it back to his family for distribution to the troops' families back home.

Additionally, the presence of a reporter within a unit indicated to the troops that they were "worth reporting on"—that is, their mission was sufficiently important to merit media coverage. This provided an additional boost. CBS reporter John Roberts with the 1st Marine Division noted that "Any time you have television with a unit it tends to be a little bit bigger deal. All the guys want to get on TV because they know the folks back home can see them."¹⁷⁷

¹⁷⁵Interviews with marines of the 1st Marine Division, Camp Pendleton, California, October 2003, and with marines of Task Force Tarawa, Camp Lejeune, North Carolina, March 2004. Interviews with the 3rd Infantry Division, Fort Stewart, Georgia, and the 11th Attack Helicopter Regiment, Ilesheim, Germany, November 2003 and April 2004, respectively.

¹⁷⁶Katovsky and Carlson, p. 101.

¹⁷⁷Katovsky and Carlson, p. 176.

The Aftermath: Civilian Planning Efforts and the Occupation of Iraq¹

*Nora Bensahel, Olga Oliker, Keith Crane, Heather S. Gregg,
Richard R. Brennan, Jr., Andrew Rathmell*

The rapid and decisive defeat of the Iraqi military forces, and the subsequent advance to Baghdad, Tikrit, Kirkuk, and Mosul, clearly demonstrated the dominance of the coalition militaries on the battlefield. The success of the campaign plan during major combat operations ensured that coalition forces simultaneously attacked Iraqi forces throughout the depth and breadth of Iraq, including major operations in the north with the Kurds, in the western desert, along the eastern border with Iran, and throughout the central Tigris-Euphrates Valley from Umm Qasr to parts of the Sunni triangle north of Baghdad. Initially, most Iraqis viewed coalition forces as liberators. Before long, however, an organized resistance began to undermine the early military success and erode Iraqi public support.

From May 2003 and continuing beyond July 2004, an insurrection mounted within Iraq. This new enemy, consisting of loose coalitions of former Ba'athists, Iraqi Islamists, and foreign fighters, waged a relentless war against coalition forces and the new Iraqi government by attacking Iraqi infrastructure, government officials, civilian targets, and coalition military. As of June 2004, the Iraqi resistance had conducted over 13,000 attacks against U.S. and coalition forces and Iraqi infrastructure.² Moreover, by June 2004 an overwhelming majority of the Iraqi public had come to view U.S. military forces as foreign occupiers rather than liberators.³ The question becomes, then, to what extent did civilian planning shortfalls contribute to this situation (military planning efforts having been addressed above, in Chapter Three)? In retrospect, what more could have been done to prevent or mitigate the difficulties the United States and its coalition partners began experiencing in Iraq?

¹ This subject is addressed in more detail in a separate report in this series, Nora Bensahel et al., *After Saddam: Prewar Planning and the Occupation of Iraq*, Santa Monica, CA: RAND Corporation, MG-642-A, 2008.

² U.S. CENTCOM, "Significant Activities Report," information current through August 15, 2004.

³ Interview with NSC official, July 2004.

Interagency Coordination

During the summer of 2002, an interagency structure called the Executive Steering Group (ESG) was established to coordinate U.S. government planning for a possible war in Iraq. At first, the ESG included representatives from the National Security Council (NSC), State Department, Defense Department, and the CIA, though over time it grew to include representatives from other agencies as well. It reported to the Deputies Committee (and, if necessary, to the Principals Committee) of the NSC and included a staff called the Iraq Political-Military Cell (IPMC). The ESG sponsored several interagency working groups below the IPMC, which focused on specific issues. The Iraq Relief and Reconstruction Working Group (IR+R) had primary responsibility for postwar issues, although some of the other working groups touched on these issues as well. IR+R was co-chaired by Elliott Abrams from the National Security Council and Robin Cleveland from the Office of Management and Budget; it included representatives from the Office of the Secretary of Defense's (OSD) Office of Stability Operations, the Joint Staff J-5, the State Department's Bureau of Population, Refugees, and Migration (PRM), U.S. Agency for International Development (USAID), the CIA, and occasionally other agencies such as the Treasury and Justice Departments.⁴ As its name suggests, IR+R focused on providing humanitarian relief in the immediate postwar period as well as on reconstruction over the longer term.⁵

The ESG, IPMC, and the various working groups represented a fairly significant effort to reach interagency consensus on strategic guidance for Iraq. Nevertheless, this structure ended up being less effective than it might otherwise have been, for two main reasons. First, ESG meetings were not always attended by every agency or by the same representatives of each agency. Attendance from OSD offices was reportedly inconsistent, with different people representing organizations at different times and with representatives often lacking the seniority necessary to make decisions.⁶ Interagency coordination suffered as a result, since OSD was the only organization that could link those planning the war with those responsible for issuing strategic guidance. Other DoD offices arrived at meetings with different positions, rather than one coordinated DoD policy.⁷

⁴ "Pre-War Planning for Post-War Iraq," information sheet published by the Office of Near East and South Asian Affairs within the Office of the Under Secretary of Defense for Policy.

⁵ Interviews with OSD official, November 2003 and March 2004, and NSC official, April 2004.

⁶ Interviews with NSC and Joint Staff officials, April 2004. The reasons for OSD's inconsistent representation remain unclear. One official noted that DoD officials generally had ambivalent feelings about the interagency process—that it provided a useful mechanism for gathering support from other agencies, but that it also required DoD to cede too much control—and speculated that this may have been one reason OSD did not make a firmer commitment to participating in this process.

⁷ Woodward, p. 321.

Second, postwar issues were not well coordinated through this structure. The IPMC spent much of its time working on postwar issues, using the work of the IR+R group as a basis for its efforts, but postwar issues rarely made it up to the ESG. The ESG focused primarily on war planning issues and devoted little attention to postwar planning.⁸ As a result, most of the postwar planning done at the working level was not discussed or approved by the most senior interagency representatives—a significant shortcoming in the planning process.

National Security Council

The NSC coordinated the interagency process described above, but it also issued strategic guidance when major combat operations in Iraq commenced. This guidance included principles for de-Ba'athification and restructuring Iraqi military and security institutions that were followed until L. Paul Bremer implemented new, more controversial, policies on these issues in May 2003.⁹

The NSC guidance called for 25,000 full members of the Ba'ath Party to be removed from their positions. This number represented just over 1 percent of the 2 million people on the government payroll, so it would enable government agencies to retain many people in managerial and technical leadership positions while removing the most senior Ba'athists.¹⁰ The NSC guidance charged DoD and the State Department to develop a coordinated vetting policy that would apply to most government officials¹¹ and to generate a de-Ba'athification plan that could be implemented by the Office of Reconstruction and Humanitarian Assistance (ORHA). All personnel would have to be vetted for involvement in human rights abuses and war crimes, as well as whether it would be politically acceptable to let them retain their positions. Ba'ath Party membership would not constitute automatic grounds for removal, but the burden of proof would fall on the individual to demonstrate why he should retain his position. Coalition officials would not pursue any subsequent rounds of de-Ba'athification, but the NSC guidance stated that when Iraq was ready to hold elections, regime records should be made public so that the voters could decide on the candidates' suitability for office.

The NSC also established some guidelines for the process of disarmament, demobilization, and reintegration (DDR) of the Iraqi military. This guidance stated that the Iraqi military should become a depoliticized military force under civilian control that would no longer threaten Iraq's neighbors and could defend the territorial integrity of the country. Its composition would also reflect Iraq's population, including a diverse set

⁸ Interview with NSC official, April 2004.

⁹ Interview with NSC official, April 2004.

¹⁰ Woodward, p. 339.

¹¹ Iraqi military and intelligence services would be vetted separately by DoD and the CIA.

of ethnic and sectarian groups. Existing Iraqi army units should be told to stay in garrison, since immediately demobilizing hundreds of thousands of Iraqi army personnel would only put them out on the street. Iraqi army units should be used to assist with reconstruction tasks in the immediate postwar period, even as their organizational structures were being reformed. Three to five regular Iraqi army divisions would need to be established and trained during the transition period, in order to form the core of the new Iraqi army. The Special Republican Guard, Republican Guard, and paramilitary forces would be disarmed and dismantled during this transition as well.

The guidance also emphasized the need to reform the government's security institutions as part of the transition process, particularly by inculcating the principle of civilian control over the military. An Iraqi national security council should be formed, controlled by the civilian commander-in-chief and various civilian deputies. The new civilian minister of defense would control all of Iraq's military forces, while the new minister of the interior would control the internal security institutions, including the national police and border guards.

Office of the Secretary of Defense

In August 2002, OSD created a new office to handle the increased workload associated with potential military operations in Iraq. It reported to Bill Luti, the Deputy Assistant Secretary of Defense for the Near East and South Asia, and included about a dozen personnel working on temporary assignment.¹² It was called the Office of Special Plans (OSP) so as not to draw attention to preparations for a possible war while President Bush simultaneously sought international support at the United Nations. OSP developed policy guidance on a wide range of issues, including the question of postwar governance, the future of the Iraqi army, and the de-Ba'athification process. Although OSP was only one player in the interagency process, representatives from other U.S. agencies thought that OSP often exerted disproportionate influence over policy, given the leading role the Department of Defense played in all aspects of planning for Iraq.

OSP developed policy guidance for the Secretary of Defense on a wide range of issues. One policy area that consumed a great deal of time and energy was postwar governance and, specifically, the process through which an interim government could be established. The key debate centered on the question of "externals versus internals"—whether the interim government should be constituted with exiles who had lived outside Iraq or with people who had remained inside the country and endured Saddam's rule. OSP staff recommended that the interim government incorporate mostly externals, since their objective was to turn power over to the Iraqis as quickly as possible.

¹² Luti reported to the Assistant Secretary of Defense for International Security Affairs, Peter Rodman, who reported to the Under Secretary of Defense for Policy, Douglas Feith.

OSP staffers concluded that it would take a long time to identify and vet internals to ensure that no Ba'athists participated in the new government; they argued that it was better to stand up a government of externals quickly—possibly even in exile before the war started—rather than wait for this process to unfold after the war.¹³ However, they were not able to secure interagency agreement on this point, since agencies including State and the CIA argued that an interim government composed solely of externals would have no domestic legitimacy.¹⁴

As part of its focus on governance issues, OSP spent a lot of time working with exile and Kurdish opposition groups. Staff members participated in a number of meetings with such groups in the late summer and fall of 2002.¹⁵ These meetings helped pave the way for the major conferences of opposition groups held in London in December 2002 and in northern Iraq at the end of February 2003.¹⁶ The office was also involved in efforts to create the Free Iraqi Forces (FIF), a military force of exiles that would be under CENTCOM's command and would be trained to fight alongside U.S. forces during the war in Iraq. OSP officials thought that the FIF would be helpful on the battlefield practically, by serving as a focal point for Iraqi defections, and symbolically, so Iraqis would be seen as liberating their own country. Although several hundred potential FIF members were trained in Hungary, fewer than a hundred of them deployed to Iraq.¹⁷ In addition to the lack of willing Iraqi volunteers, the FIF suffered from a

¹³ Interviews with OSD officials, August 2004.

¹⁴ OSD officials later expressed a great deal of frustration with this decision, arguing that the interim government that took power on June 28, 2004, was composed exclusively of exiles. They argued that the same government could have been in place in the fall of 2003 but for interagency opposition to their plans, and the faster transition would have resulted in much less opposition to the continuing U.S. presence in Iraq. Interviews with OSD officials, August 2004.

¹⁵ Interviews with OSD officials, August 2004. Some of these meetings were co-sponsored with the State Department. See Peter Slevin, "Iraqi Opposition Pledges Anti-Hussein Unity," *Washington Post*, August 10, 2002; Michael R. Gordon, "Iraqi Opposition Groups Meet Bush Aides," *New York Times*, August 10, 2002; Michael R. Gordon, "Iraqi Opposition Gets U.S. Pledge to Oust Hussein for a Democracy," *New York Times*, August 11, 2002.

¹⁶ The December and February meetings were officially organized by Zalmay Khalilzad, who was appointed Special Presidential Envoy and Ambassador at Large for the Free Iraqis on December 2, 2002. See Michael Howard, "Conference Delegates Vie for Political Role in New Iraq," *The Guardian* (London), December 16, 2002; Andrea Gerlin, "Iraqi Opposition Groups Agree on Power-Sharing Plan," *Philadelphia Inquirer*, December 18, 2002; Gareth Smith, "Emboldened Opposition Gathers," *Financial Times*, February 27, 2003; Judith Miller, "Iraqi Leadership Team to Prepare for a Transition to Democracy," *New York Times*, February 28, 2003; Judith Miller, "Ending Conference, Iraqi Dissidents Insist on Self-Government," *New York Times*, March 3, 2003.

¹⁷ After the fall of Baghdad, the U.S. military airlifted Ahmad Chalabi and several hundred armed personnel to the northern part of Iraq. These people were described as part of the FIF, but it is unclear whether they received official training in Hungary as part of that program or were more hastily assembled and designated as part of the FIF. On prewar FIF training, see Greg Jaffe, "On a Remote Base, U.S. Drill Sergeants Train Iraqi Exiles," *Wall Street Journal*, February 24, 2003; Adam LeBor, "Exiles Prepare for a Happy Return at Camp Freedom," *The Times* (London), February 24, 2003; Ian Traynor, "U.S. Closes Exiles Training Camp After Only 100 Show Up," *The Guardian* (London), April 2, 2003. On the airlift into northern Iraq, see Peter Finn, "New Force Moves

lack of enthusiastic support within the interagency process. In particular, CENTCOM opposed relying on large numbers of Iraqis during the military campaign, reportedly because they would not add significant military capabilities and might increase risk to U.S. military personnel if they were not vetted properly.¹⁸

OSP also developed policy guidance on the future of the Iraqi army and the de-Ba'athification process, which both became controversial issue areas after the Coalition Provisional Authority took power. OSP assumed that the army would continue to exist after the war ended and that it could be used for reconstruction projects while its personnel were being vetted and its units reconstituted.¹⁹ OSP also helped develop a de-Ba'athification policy that would automatically remove the top three layers of party officials and prevent them from holding public positions in the new government.²⁰

Many people who were interviewed for this report claim that OSD officials were dictating policy to other U.S. government agencies.²¹ The very existence of the Office of Special Plans—and the confusion surrounding its creation, purpose, and name—may have given its guidance disproportionate weight during the interagency planning process, thus leading many government officials to believe that OSP's "contributions" were de facto instructions. Clearly, there was frustration that OSP's guidance papers had not been coordinated with other agencies before the meetings in which they were presented.²² OSD officials counter that all of their planning efforts fed into the interagency process discussed at the beginning of this chapter, and that they lacked both the authority and intent to dictate policy to their counterparts in other agencies.²³ Nevertheless, because the Department of Defense seems to have been perceived by others as first among equals within the interagency planning process, OSD's influence may indeed have been disproportionate.

This perception was likely exacerbated after the Department of Defense was officially designated the lead agency for postwar planning. The Principals Committee apparently reached this decision in October 2002, to ensure that there would be one

to Gain Sway," *Washington Post*, April 12, 2003; Rupert Cornwell, "U.S.-Backed Iraqis Launch Bid for Power," *The Independent* (London), April 13, 2003; Peter Finn, "Pentagon's Iraqi Proteges Go Home to Mixed Welcome," *Washington Post*, April 17, 2004.

¹⁸ Interviews with OSD officials, August 2004.

¹⁹ This assumption was incorporated into the planning efforts of the Office for Reconstruction and Humanitarian Affairs (ORHA).

²⁰ Interviews with OSD official, August 2004. This was commonly referred to as the "last Ba'athist standing" policy.

²¹ Interviews with State Department official, October 2003, and ORHA officials, November 2003 and January 2004.

²² Interviews with State Department official, October 2003, ORHA officials, November 2003 and January 2004, and OSD official, August 2004.

²³ Interviews with OSD officials, August 2004.

U.S. government agency in charge of postwar Iraq. The Principals wanted to avoid some of the problems plaguing postwar Afghanistan, where responsibilities for reconstruction were divided among several different coalition partners and U.S. agencies.²⁴ The Principals agreed to centralize all the postwar planning efforts that were under way by creating a single office with extensive interagency representation, even though DoD would be in the lead.²⁵ OSD developed a few concepts of how such an office might be organized. A delay occurred after this decision was reached in October, for the Department of Defense was not designated as the postwar lead agency until January 2003. None of the officials interviewed for this report could explain that delay, though some speculated that senior officials may have had difficulty selecting a person to lead the new office, or that naming a postwar coordinator in October might have undermined ongoing diplomatic efforts at the United Nations.²⁶

The State Department

The State Department sponsored the most comprehensive assessment of postwar requirements conducted within the U.S. government. This effort, called the “Future of Iraq” project, brought together Iraqi exiles and academic experts in 17 different groups to work on such postwar issues as transitional justice, democratic principles, defense policy, economy and infrastructure, and civil society. The reports from the working groups were of uneven quality. Taken together, they did not constitute an actionable plan that could have been implemented in Iraq, but they did correctly identify many of the reconstruction and governance challenges that emerged after major combat operations ended. Though the Future of Iraq project continued its work throughout 2002 and early 2003, the State Department as a whole remained on the margins of the postwar planning process.

Representatives from various offices within State did participate in and influence the outcomes of the official interagency planning process described earlier in this chapter, but State as a whole never effectively influenced the planning process. Why was this the case? One reason is that State never developed a single agency position. Bureaucratic tensions among the various bureaus within the State Department are a perennial problem, and the individuals who participated in the planning process reflected the views of their own bureau rather than a coherent position of the depart-

²⁴ Interview with OSD official, August 2004.

²⁵ As Douglas Feith later noted, “Bush gave Rumsfeld overall authority for the postwar plan, to maintain what he called ‘a unity of concept and a unity of leadership’ . . . Since so many of the responsibilities were military security responsibilities, the only person who could really do that was the secretary of defense.” Mark Fineman, Robin Wright, and Doyle McManus, “Preparing for War, Stumbling to Peace,” *Los Angeles Times*, July 18, 2003.

²⁶ Interviews with OSD officials, August 2004.

ment. These views emphasized different points at best, and directly contradicted each other at worst. This reduced State's ability to influence policy formation and frustrated many other agency representatives who complained that interagency meetings only work when each agency shows up with a single coordinated position.²⁷

A second, and perhaps more important, reason for State's lack of influence is that senior U.S. officials believed that State opposed the possibility of war with Iraq. Many State Department officials supported strengthening the UN sanctions regime before threatening regime change, while senior policymakers—apparently including Vice President Cheney and Secretary of Defense Rumsfeld—had already concluded that diplomatic approaches, particularly through the UN, would be ineffective.²⁸ OSD officials remained concerned throughout the planning process that any criticism from State was ultimately designed to undermine the policies OSD supported. State Department officials report that representatives from the Bureau of Intelligence and Research (INR) were largely ignored during scenario planning meetings they attended and claim they were deliberately not invited to a DoD-sponsored wargame during the summer of 2002.²⁹

These two factors combined to make the State Department a weak player in interagency preparations for postwar Iraq. Even though the Future of Iraq project was the most comprehensive effort within the U.S. government to examine the challenges and requirements of Iraq after Saddam, its insights and suggestions largely did not influence postwar planning efforts within the interagency process. The project remained stovepiped within the State Department, and those who were not directly involved knew very little about its efforts or even about its existence. In fact, the project was not allowed to be officially briefed to the interagency community until October 2002, reportedly because of concerns that it would be dismissed as another State Department effort to undermine support for the war by identifying postwar challenges.³⁰ Internal bureaucratic challenges and external suspicion about State's true motives, therefore, combined to marginalize State's influence on the postwar planning process, as well as to limit the dissemination of ideas and information from the Future of Iraq project.

²⁷ Interview with former State Department official, October 2003.

²⁸ The Bush administration opposed involving the United Nations or discussing sanctions until August 2002, when Secretary Powell convinced the President that a renewed diplomatic effort involving the United Nations was a necessary precondition for building international support for possible military operations against Iraq. Woodward describes part of this discussion as follows: "Powell believed he had Cheney boxed in, and to a lesser extent Rumsfeld. [Powell] argued that even if anyone felt that war was the only solution, they could not get to war without first trying a diplomatic solution. It was the absolutely necessary first step . . . Powell believed he had them, although he sensed that Cheney was 'terrified' because once the diplomatic road was opened up, it might work." Woodward, pp. 154–157; quote from pp. 156–157.

²⁹ Interviews with former State Department officials, October 2003 and March 2004.

³⁰ Interview with State Department official, July 2004.

U.S. Agency for International Development

USAID's planning for postwar Iraq began informally in the summer of 2002, although it did not receive formal tasking to begin planning until early 2003. The agency was instructed to develop plans for actions and responses in the event of a war in Iraq. USAID developed a plan in the fall of 2002, even though it did not have personnel on the ground in Iraq at that time and lacked reliable information about conditions there. The plan included "branches" for several possible contingencies, such as the use of weapons of mass destruction, and was continually refined through the winter and early spring.³¹

USAID's planning efforts drew on its considerable experience with post-conflict humanitarian relief and reconstruction activities throughout the world.³² Its plans for Iraq focused on providing and reconstituting electricity, water and sewers, public health, education, local government, agriculture and food supply, and roads and buildings, among other issues. USAID tried to gather as much current information about Iraq as possible, but such information was spotty. For example, the CIA was able to provide information about ports, airports, and targeting issues, but it could not provide USAID with information about infrastructure and basic services because it had not been tasked to collect that information. CIA information did help USAID planners understand that they would most likely need to import fuel because of the limitations of the Iraqi oil refineries. USAID was then able to contract with the Defense Logistics Agency (DLA) and others to provide fuel. Plans were also developed to increase electrical production and to connect Iraq to local and regional power grids.³³

USAID carries out the vast majority of its projects by contracting with international organizations (IOs), nongovernmental organizations (NGOs), and private companies. USAID reportedly began assessments to support contract allocations as early as August 2002, and in mid-September, it started holding weekly coordination meetings with relief agencies and NGOs.³⁴ On January 16, 2003, the director of USAID, Andrew Natsios, signed the order authorizing local procurement for Iraqi relief and reconstruction. An amount of \$63 million was initially allocated for this mission, and USAID let 11 contracts almost immediately after the order was signed. Before the war commenced in March 2003, USAID had awarded numerous contracts and grants for

³¹ Interviews with OSD official, November 2003, and USAID official, May 2004.

³² USAID planners successfully argued that humanitarian relief and reconstruction were interrelated tasks and needed to be addressed together, rather than as separate steps in a process. USAID's planning for Iraq thus considered both relief and reconstruction to be part of a single operation. Interview with U.S. government official, May 2004.

³³ Interview with USAID official, May 2004.

³⁴ Fallows, p. 62; interview with USAID official, May 2004.

key tasks in infrastructure reconstruction, education, and government support.³⁵ Some NGOs chose not to sign contracts with USAID, seeing U.S. government money as tainted by the continuing preparations for war.³⁶

The Office of Reconstruction and Humanitarian Assistance

On January 20, 2003, the National Security Council issued National Security Presidential Directive 24, which gave the Department of Defense primary responsibility for postwar Iraq and tasked DoD to form a new office to take charge of planning. Retired Army Lieutenant General Jay Garner was named to lead this new office, which became known as ORHA. Although it was supposed to be composed of interagency personnel, many of its early staff members were military personnel because U.S. agencies proved reluctant to provide staff for ORHA.

ORHA personnel soon discovered that the many administrative issues involved in setting up their organization left little time for substantive issues and long-term planning. ORHA did plan for possible humanitarian relief operations, drawing on interagency relief plans prepared elsewhere. It also developed the concept of Ministerial Support Teams to ensure that Iraqi ministries continued to function between the fall of Saddam Hussein and the establishment of a new permanent government. These concepts were discussed at a meeting held at the National Defense University on February 21 and 22, 2003. This meeting included representatives from every U.S. government agency that would have a role in reconstruction. The meeting revealed several serious shortcomings in preparations for dealing with a postwar Iraq: U.S. agencies were reluctant to provide personnel for the ministerial teams, and the question of who would provide postwar security in Iraq remained unaddressed. Both of these issues would later pose significant problems for both ORHA and its successor, the Coalition Provisional Authority (CPA).

ORHA deployed to Kuwait between March 9 and March 16, 2003. Many staff members would have preferred to remain in Washington longer, to further develop working relationships with their counterparts throughout the U.S. government. Once in Kuwait, ORHA learned that, because of security issues, CFLCC did not want ORHA to collocate with its forces at Camp Doha. In the absence of any alternatives, ORHA set up its headquarters at the Kuwait Hilton, which was approximately 45 minutes away from Camp Doha and lacking in rudimentary communications and infrastructure.

³⁵ Contracting in the areas of health and economic growth reportedly lagged behind. Treasury was the lead agency for contracting on economic growth, which posed interagency coordination challenges, and USAID health personnel found that integrating a possible combat environment into their plans posed some unexpected challenges. Interviews with U.S. military officer, November 2003, and with U.S. government official, May 2004.

³⁶ Interview with USAID official, May 2004.

While in Kuwait, ORHA's planning efforts were limited by ineffective working relationships with CFLCC as well as by ORHA personnel not being privy to the warplans until shortly before the war started. ORHA had planned to enter Basra and start reconstruction efforts as soon as coalition military forces secured that city, but during the second week of March, Garner learned that the warplans called for most military forces to go straight to Baghdad instead of remaining in rear areas to provide security, thus rendering many of ORHA's plans obsolete. CFLCC directed ORHA to remain in Kuwait while major combat operations were conducted throughout Iraq. Not only did this render ORHA's plans ineffective, but once Baghdad fell and the looting started, it exposed ORHA to charges that it was doing nothing to stop the destruction of the country.

ORHA began entering Baghdad on April 21, after Garner personally requested and received permission to do so from General Franks. ORHA quickly discovered that conditions in Iraq were extremely different from those originally anticipated. The expected humanitarian crisis had never materialized, while extensive looting had damaged much of the infrastructure that the military campaign had deliberately left intact. Furthermore, continuing combat operations meant that ORHA was not operating in a benign environment. The unsettled security situation significantly hindered ORHA's reconstruction efforts.

On April 24, the day that Garner arrived in Baghdad, he received a phone call from Secretary of Defense Rumsfeld informing him that President Bush intended to appoint L. Paul Bremer as his permanent envoy to Iraq. The specific reasons for this decision remain unclear, although the unexpected looting and chaos were almost certainly important factors.³⁷ U.S. officials officially announced Bremer's appointment on May 6, and he arrived in Baghdad on May 12 with a mandate to create a new Coalition Provisional Authority. Unlike ORHA, CPA would possess all the powers of an occupation authority. ORHA's staff shrank as CPA's grew, with few ORHA personnel choosing to stay on and work for CPA. Garner left Iraq on June 1, almost two weeks after ORHA had been superseded by CPA.

³⁷ This decision set off speculation that Garner had been fired because ORHA had proved unable to address the challenges of postwar Iraq. Garner has explicitly denied that he was fired, stating that the plan had always been for him to stand up ORHA and then transfer power to a permanent presidential envoy within a few months. Others, both inside and outside the administration, interpret these events less charitably, arguing that their timing was designed to convey the impression that Bremer was making a clean start. Critics expressed great frustration that no administration officials said anything to support Garner after this dismissal or to correct the impression that he had been fired. See transcript of Jay Garner interview, dated July 17, 2003, for a *Frontline* episode called "Truth, War, and Consequences," first aired on October 9, 2003. As of March 2008: <http://www.pbs.org/wgbh/pages/frontline/shows/truth/interviews/garner.html>

Also see interviews with ORHA officials, November 2003, December 2003, and April 2004; and interview with State Department official, January 2004.

Humanitarian Planning

The U.S. government planned extensively for the humanitarian relief efforts that a war with Iraq might require, particularly how to handle massive refugee flows and shortages in food, water, and medicine. An interagency planning team started meeting in the fall of 2002 and worked with international organizations and NGOs to generate detailed humanitarian relief plans across a range of possible scenarios. As it turned out, because of the rapid speed of military operations, which left supply networks largely intact, the war in Iraq did not generate significant humanitarian requirements. This does not mean that humanitarian planning efforts focused on the wrong areas. They helped ensure that humanitarian concerns were factored into the warplans; moreover, worst-case scenario planning for any potential humanitarian disaster seemed highly prudent. However, it is important to note that humanitarian relief plans are *not* the same as reconstruction plans. The detailed preparations for providing food, water, and shelter to needy Iraqis stand in stark contrast to the dearth of plans for reconstruction of the country.

The Occupation of Iraq

Drawing in part on the U.S. experience in DESERT STORM, Army planners anticipated that several issues would have to be dealt with once the major fighting ended. They anticipated a large number of refugees, for example, and they also expected that U.S. forces would have to cope with a substantial number of prisoners of war. As it happened, none of the anticipated challenges came to pass. The Iraqi army simply went home rather than surrendering. Civilians also stayed home, where they had stockpiled food. The speed of the advance limited the sort of intense combat that tends to generate large numbers of refugees. Instead, the most significant challenge turned out to be widespread civil unrest and looting. This is not to say that the planning was off the mark or wasted. The oil fields and major hydroelectric facilities were safeguarded. Had adequate forces not been there, it is possible that they, too, would have been looted and severely damaged, if not destroyed. The looting was so thorough in many instances that only the shells of buildings remained.

U.S. forces were ill prepared to cope with the civil violence. They started out short-handed because two divisions were still not in position when the major fighting ended. Nor were they the right type of forces. They were largely mechanized or armored forces, well suited to waging major battles but not prepared to restore civil order. That task would have been better carried out, ideally, by military police or, acceptably, by light infantry trained in urban combat. Because U.S. forces were not prepared and because appropriate high-level planning had not occurred, it took some time for them to react to the situation, and by then much of the major damage had

been done. Buildings were not only stripped of their furniture and equipment, but also doors, windows, light fixtures, plugs, wiring—in short, anything that could be carted away. Anything left behind was often burned. The breadth and depth of the looting and destruction had major implications for post-combat operations.

Initially, policymakers viewed the civil unrest as the natural aftermath of the dissolution of Saddam's government and thought that it would pass. As it became clear that the dimensions of the problem were greater than first thought, U.S. forces were sent into various troubled areas to restore order. Generally, they arrived too late to preclude the extensive damage caused by the looting. While some level of stability was restored in the north and the south, in part due to actions by Iraqis, Baghdad and surrounding areas remained in turmoil.

Despite the efforts of coalition forces, unrest continued, particularly in and around Baghdad. Figure 8.1 shows that the situation appeared to be improving in the winter of 2004, when the average number of weekly attacks fell below those during the fall of 2003. But the violence escalated notably during April 2004, with some confrontations, notably those with the supporters of Shi'ite cleric Moqtada al-Sadr, being particularly

Figure 8.1
Average Number of Daily Attacks by Insurgents in Iraq, June 2003 to June 2004

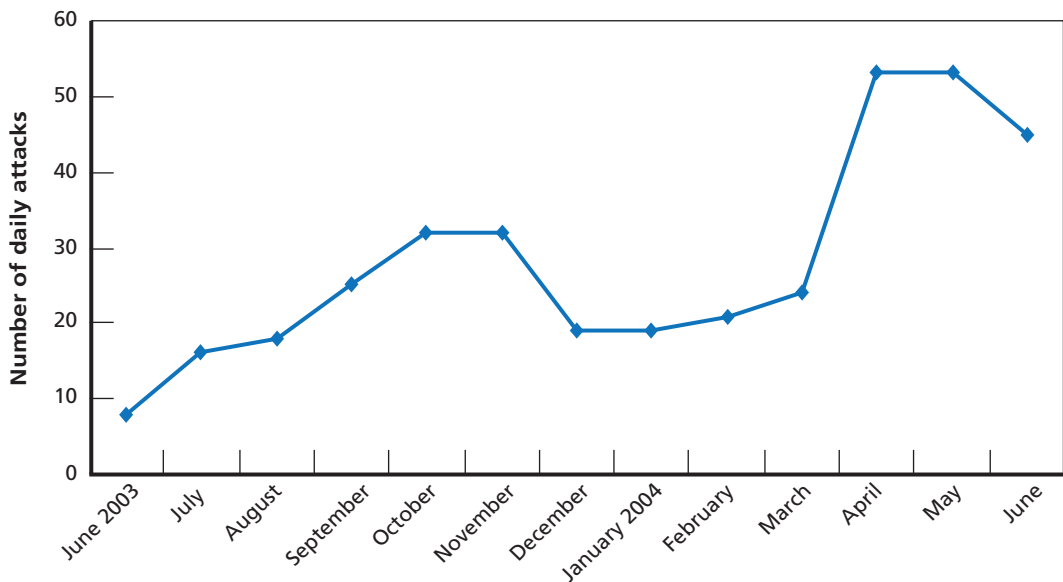

SOURCE: The Brookings Institution Iraq Index, September 6, 2005.

NOTE: Numbers for June 2003 are incomplete.

RAND MG641-8.1

violent. Nor were attacks limited to coalition forces. They spread to UN and Iraqi security forces, interim Iraqi government officials, and ultimately to ordinary Iraqis.³⁸

Governance Structures: CPA and Iraqi Institutions

From spring 2003 through the handover of power to the Iraqi Interim Government on June 28, 2004, OIF encompassed a variety of reconstruction tasks. In addition, the coalition powers that contributed forces to the military campaign retained responsibility for governing Iraq, for they were, legally and functionally, occupying powers in that country.

Coalition forces thus had two simultaneous and sometimes competing missions: to run the country and to build up Iraqi institutions that would enable self-rule. In May 2003, when the CPA took over from ORHA and L. Paul Bremer became the Administrator of Iraq, it was not clear how long CPA would govern and how much time would be available to build up the Iraqi government. A November 2003 decision to accelerate the handover of power to July 1, 2004, exacerbated the tension between the two missions.

CPA was a complicated entity. Simultaneously a U.S. government agency and an international organization, it had personnel from a variety of coalition countries serving as advisors both to Iraqi ministries and to CPA itself. It governed primarily by issuing Orders (directives with the force of law), signed out by Ambassador Bremer, as well as by working through Iraq's ministries (see below). Its first order instituted de-Ba'athification, a planned policy to eliminate Ba'ath Party senior personnel and structures from Iraqi government. Over time, the scope and implementation of this policy would be viewed as overly severe.

Although the CPA was the governing body of occupied Iraq, it was not the only coalition structure in country, and it did not have authority over all other structures. Combined Joint Task Force 7 (CJTF-7), the military command, which reported to CENTCOM, was a separately functioning body.³⁹ Intelligence agencies representing coalition countries, including the CIA, also did not report to CPA; nor did the Iraq Survey Group, which continued its hunt for WMD. Relations between these groups varied. While personal relations were often good, failures of coordination and information sharing sometimes created significant tensions, most commonly between the civilian and the military arms of the occupation.

³⁸ This analysis covered military activities up through the transfer of authority and the end of the occupation in June 2004.

³⁹ Once the CPA was established, military control of coalition forces passed from CFLCC to CJTF-7, which was led by the commander of U.S. V Corps. See Chapter Seven for a discussion of CJTF-7.

Moreover, in the process of creating and reconstructing Iraqi governance institutions, CPA and CJTF-7 built Iraqi counterparts to and for themselves. At the national level, there were the Iraqi ministries that survived the defeat of Saddam (now stripped of their senior Ba'ath-affiliated leadership); new ministries, established by CPA; and the Iraqi Governing Council (IGC). Following the structure established by ORHA, CPA maintained a senior advisor and an advisory staff for each ministry; these CPA personnel both ran the ministries and sought to build them up institutionally. The extent of involvement varied. Some ministries, such as the Ministry of Interior, were so decimated by the combination of Saddam's rule and the war that they required tremendous assistance for both day-to-day functioning and institution building. Others, such as the Ministry of Foreign Affairs, retained sufficient numbers of competent staff that they needed less support.

Prewar planning had anticipated that exiles would have a crucial role in forming the new government, but it also expected a rapid handover of power, predicated on a stable post-conflict situation. Instead, CPA built governance structures under the tremendous strain of a deteriorating security situation that did not welcome exiles. At the same time, the CPA staff's lack of access to other Iraqis resulted in continued reliance on exiles in the building of a new Iraq. An example was the Iraqi Governing Council. The CPA appointed the IGC—a multi-ethnic, multi-sectarian, and exile/Kurdish-dominated body—on July 13, 2003, after considerable debate and discussion about what form the new Iraqi government should take. While it was never popular with Iraqis, this 25-person body became over time an increasingly independent actor and CPA's primary Iraqi interlocutor.

The IGC and CPA were the two bodies that issued the November 15 agreement in late 2003. This document promised that CPA's tenure would end, and an Iraqi government would take power, by July 1. It also required that a "basic law" or interim constitution be drafted by February 28, 2004. This law would lay out the structures of the interim government that would take over when CPA disappeared, as well as processes for selecting the permanent government that would follow the interim government.

Following the November 15 agreement, the Ayatollah Sistani, a prominent Shi'ite religious figure, issued a fatwa calling for direct elections of any Iraqi government. This spurred significant debate and discussion within Iraq and coalition countries regarding the need for and feasibility of direct elections of the new government.

The process of drafting the basic law, or Transitional Administrative Law (TAL) as it came to be called, took place largely in the first two months of 2004. A variety of issues came to the forefront in TAL discussions, including guarantees of human rights, such as the rights of women; the role of Islam; and the sore question of regional autonomy for the Kurdish-dominated north. Structures of government and the role of the presidency and prime minister were other prominent issues involved in these discussions. Debate over many of these key points kept the IGC from reaching full agreement on the TAL by the deadline. Ambassador Bremer and his staff pushed the

drafters to continue work on the document into the early hours of March 1, 2004, when agreement was finally reached.

The IGC played its final role as the transfer of power approached. On March 17, it petitioned the United Nations for help in forming an interim government, and from that time on it worked with CPA, the United Nations, and U.S. Special Representative Robert Blackwill to define the structure and personnel for the new government. On June 1, 2004, the Iraqi Interim Government (IIG) was announced, with Iyad Allawi, formerly chair of the IGC security committee, as prime minister and Sheikh Ghazi Yawar as president. Two deputy presidents, as prescribed in the TAL, and a new cabinet were also selected. This new government then worked with CPA, the UN, and coalition capitals to facilitate the transfer, which took place on June 28.

Local governance structures in Iraq followed a rather different pattern. Initially, these were primarily built up with the help of local CJTF-7 commanders, who were the only coalition personnel on the ground during and immediately after the end of major combat operations in May 2003 (although there were also some indigenous efforts to create local governance). CJTF-7 commanders worked with local leaders they could identify to create councils, mayoralities, and other bodies. The structure of these varied, as did their role in governance vis-à-vis coalition personnel. In many ways, local government creation was separate from the effort to create new national-level structures. In November 2003, as CPA began to deploy local governance teams throughout the country to take over from the military-dominated effort, they undertook a “refreshment process” for local government: to evaluate its status in various regions, improve legitimacy, and create representative local caucuses.

Security Forces and Institutions

One of the greatest challenges faced by CPA and CJTF-7 in their efforts to reconstruct and govern Iraq was the creation of new Iraqi security forces. Prewar planning assumptions—that the old Iraqi military could undergo a process of demobilization, disarmament, and reintegration (DDR) while helping ensure security during the interim period, and that police forces would remain largely intact and ensure law and order—proved deeply flawed. CPA was soon rebuilding both a military and a police force, as well as facing the challenges of defining Iraq’s intelligence collection and analysis needs (even as the CIA and other agencies not under CPA control proceeded to build an Iraqi intelligence service).

Efforts to organize security sector restructuring, as well as to run the security sector, were beset by difficulties. The notion of consolidating the effort to build both intelligence and internal and external security structures was not implemented until the very end of 2003, at which point the various projects were highly stovepiped. Indeed, CPA officials initially believed that Iraq would not need intelligence services and only

got involved in their development when it became clear that they were being built nonetheless. Integrating the effort to build the police force with that of building the military was hampered by bureaucratic battles and competing priorities within CPA.

Iraq's armed forces and its Defense Ministry were formally dissolved, along with a number of other Saddam-era security-related structures, by CPA Order Number 2, issued on May 23, 2004. From the viewpoint of CPA officials, this was done in large part because the military no longer existed—soldiers had gone home, leaving looted facilities, as U.S. forces moved through Iraq. The police had also deserted their posts in large numbers, but in this case, the initial goal was to bring them back to work.

The Iraqi police service, historically a powerless and corrupt structure, was suddenly expected to be the front line for internal security—in a deteriorating security situation. CPA's advisors to the Ministry of Interior (MoI), which had responsibility for police, were short-staffed and constantly torn between the effort to build effective structures and the need to get police on the streets and patrolling. This tension was exacerbated by a failure on the part of coalition capitals to recognize the crucial nature of the police mission and allocate sufficient resources to it. MoI and its advisors lacked civilian police trainers, funds, and staff. As a result, far more people were hired than could be trained, and training remained haphazard. Perhaps not surprisingly, at times of crisis, the Iraqi police response proved highly variable. Plans to build special forces with specific capabilities, such as counterterrorism skills, were drawn up but hard to implement, in part due to insufficient resources and holdups on those resources that were allocated. In addition, MoI was also responsible for building both a facilities protection service, charged with protecting core infrastructure, and a border control force; these were no less important than the police and no less plagued with problems.

Military training was better structured, since there was less immediate need for Iraqi military forces and more prewar planning existed (CENTCOM had always planned on a new military for Iraq but had expected to be able to rely more on the structures of the old one). Military personnel could readily be hired, trained, and then deployed. In addition to the Iraqi armed forces, coalition troops also developed the Iraqi Civil Defense Corps (ICDC), which served as an Iraqi auxiliary of various sorts to coalition troops. This rapidly growing structure, which enabled the employment of large numbers of Iraqis with military and other security experience, had limited training and capabilities, but the ICDC was crucial to putting an Iraqi face on coalition operations. The building and staffing of the Defense Ministry, undertaken by CPA staff, also proceeded slowly initially, but sped up after the November 15 agreement.

Several problems plagued the building of Defense Ministry forces. Crucial was the question of mission—whether such forces should be built for defense against external threats, or to help in the current conflict. Coalition military forces had long held the vision that Iraqi armed forces, once built, would help the coalition. The forces in question, however, were structured for a defensive, nonaggressive, role in defending the country from external attack. Early efforts to use units domestically led to refusals to

fight and desertions (although it is worth noting that desertions had previously been a problem attributable to low pay). The ICDC, also, had mixed results in this regard.

The CIA, which, as noted above, was not subordinate to CPA, had the task of building the Iraqi national intelligence service. However, it was quickly clear that both the Defense Ministry and the Ministry of Interior would have intelligence functions. CPA attempts to coordinate efforts to rebuild Iraq's intelligence infrastructure began in November 2003, but they were consistently hampered, as elsewhere, by the stovepiping that had already set in by then. The situation was exacerbated by MoI's underresourcing, which made it a difficult interlocutor in this as in other matters, and by the CIA's independence. As a result, the structures, functions, and coordination of Iraq's intelligence agencies and organizations were underdeveloped and confusing at the time that the IIG took power.

No discussion of security forces is complete without an understanding of the role of militias. A number of groups had fought against Saddam, and these had to be either disbanded or somehow brought under the control of the new Iraqi government. Although discussed for many months, efforts in this area did not begin in earnest until February 2004. Critical to these efforts was the adoption of the TAL, which would make all armed forces and militias not under federal control illegal in the new Iraq, except as provided by law. This meant that either organizations had to disband via a legal process over time that required them to meet benchmarks or they would be treated as outlaws.

A CPA order brought this process into force prior to the entry into force of the TAL. It enabled CPA staff to work with key militias, including the Kurdish peshmerga, to define ways for their personnel to transition into retirement, job training, or new Iraqi security forces. However, the implementation of this process had barely begun at the time the IIG took power.

Economic Policy and Reconstruction

Economic policy was another area for which there was little advance planning before the war, partially due to the assumption that the occupation period would be short and that oil revenues would soon provide substantial income for the new government. Under CPA, coalition advisors sought to create an economic structure that would foster entrepreneurship and foreign investment. They faced opposition in some of these efforts from the IGC, which tended to prefer the status quo.

In this area, as in others, CPA had simultaneously to build institutions and to run the government. This task included resumption of government services to the public and payments to civil servants, pensioners, and employees of state-owned enterprises. In late 2002, the U.S. Treasury defined a payments strategy based on using seized funds from the prior government. But the breakdown of government operations as a

result of the war meant that the Iraqi Ministry of Finance did not have cash to make payments immediately. CPA used what money it could find, as well as U.S. dollars flown in from the United States.

CPA was successful in reviving the Central Bank of Iraq, implementing a new currency and exchanging it for the old. It declared a tax holiday and lifted tariffs and importing restrictions for 2003, and it issued a law on foreign direct investment. CPA also defined a budget for the second half of 2003 and for 2004: the first in dollars, the second in dinars. The consulting firm Bearing Point was hired to train the Ministry of Finance in a modern financial management information system.

More problematic were efforts to liberalize prices, particularly for gasoline and fuel; to fully reform the food rationing system; and to restructure state-owned companies so that they could function in a modern economy. Plans to downsize and close such structures ran into opposition from the Iraqi Governing Council. CPA's failures to reform Iraq in these areas led to both continued economic waste and potentially slow reconstruction.

CPA also had the task of restoring essential services. It hoped to improve provision of services above what it had been under Saddam Hussein, but CPA soon found that the best it could do was to focus on the basic provision of water, oil, and electricity. Iraqi infrastructure was damaged both by the 1991 Persian Gulf War and by years of sanctions and neglect afterward. OIF and particularly the looting that ensued did additional damage to the capacity to produce electricity, oil, and water. This was a surprise to coalition forces, who expected to provide food and water to refugees and protect the oil sector. They did not, however, expect to carry out large-scale reconstruction.

Reconstruction was mostly pursued through contracting mechanisms. Because there was some expectation of work in this area, USAID awarded a number of contracts early on. Halliburton subsidiary Kellogg, Brown and Root, Bechtel, and other contractors were awarded large contracts to work on the oil fields, electricity, government buildings, ports, airports, and so forth. Other contracts were let throughout 2003.

Recognizing the job was bigger than expected, in November 2003 CPA set up a Project Management Office (PMO) to handle contracting. Its role was to ensure that CPA satisfied legislative rules and appropriate accountability standards. It let one program management contract to support its own efforts and to oversee reconstruction in specific sectors, as well as six other contracts to coordinate reconstruction in electricity, oil, public works and water, security and justice, transportation and communications, and buildings and health. The PMO also planned to award 15–20 design-build contracts for specific tasks. Thus, initially, USAID and the U.S. Army Corps of Engineers carried out most of the contracting, subject to CPA oversight. Later the PMO, working with and through these and other agencies, had the authority to issue contracts and played this oversight role.

Throughout CPA's tenure, reconstruction continued to be funded through a variety of mechanisms. These include U.S. appropriations; Iraqi oil export earnings, deposited in the Development Fund for Iraq; accrued assets, including seized assets of Saddam or the Ba'ath Party; funds from the UN Oil for Food account; and promises of assistance from other donors.

The success of reconstruction was mixed. In the oil sector, output and exports were successfully restored, though not quite to prewar levels. Electricity was more problematic, with a variety of contractors and a complicated structure. Much of the work on public buildings, roads, bridges, schools, and so forth was carried out using commanders' discretionary funds. In the areas where CPA was involved, its senior advisors, not Iraqi ministers and their staffs, made the bulk of the decisions.

At the time CPA handed over power to the IIG, electric power generation was near prewar levels, while oil production was below its prewar peak and hampered by sabotage. Water provision, however, had improved, and mobile telephone service helped compensate for lagging fixed-line provision. A variety of factors contributed to continuing problems, including the failure to plan for reconstruction, the effects of looting (and the failure to prepare for looting), subsidies that encouraged overuse of electricity, and the security situation, which slowed contractor work and added to costs. Thus, CPA fell behind on its reconstruction schedules. Expenditures were also slowed by contracting procedures, which remained rooted in a peacetime structure and mind-set for letting contracts.

Assessing Postwar Efforts

Why was the U.S. government so unprepared for the challenges of postwar Iraq? Three sets of factors interacted to produce this outcome.

1. **Unchallenged assumptions and expectations.** U.S. government planning efforts for postwar Iraq did not address a range of scenarios, but instead were based on a set of assumptions that were never seriously challenged. When actual postwar events proved that most of these assumptions had been faulty, the United States had no alternate plans to turn to. Instead of being able to shape events, it had to react to them.
2. **Ineffective interagency coordination.** Many U.S. agencies conducted postwar planning efforts, but these efforts were not effectively coordinated or integrated. The National Security Council did oversee a formal interagency coordination process, but it focused primarily on humanitarian relief efforts rather than reconstruction requirements—largely because of the assumption that reconstruction requirements would be minimal. Throughout the planning process, tensions between the Defense Department and the State Department were

never mediated by the president or his staff. Although DoD was named the lead agency for postwar Iraq in January 2003, DoD's lack of capacity for civilian reconstruction planning and execution continued to pose problems throughout the occupation period.

3. **Security as the key postwar task.** The single most important failure in the postwar planning and execution process was the failure to assign responsibility and resources for providing security in the immediate aftermath of major combat operations. This problem was raised during the planning process, particularly at the February 2003 conference that ORHA convened, but was never satisfactorily resolved. The failure to plan for stability operations had very serious repercussions that hindered the United States throughout the occupation period. This failure continued to threaten U.S. military forces and the Iraqi government. The main lesson for the Army to draw from the Iraqi experience is that Army forces will—of necessity—be responsible for providing security throughout any postwar transition period, until local forces can be reconstituted or retrained. Phase IV missions, responsibilities, and resources need to be addressed as thoroughly as they are for Phase III operations.

Mobilization, Deployment, and Sustainment in Operation IRAQI FREEDOM

Eric Peltz, Dave Kassing, Chad Yost, Marc Robbins, Kenneth Girardini, Brian Nichiporuk, Peter Schirmer, John M. Halliday, John R. Bondanella

This chapter discusses the mobilization, deployment, and sustainment of forces for OIF. The mobilization and deployment discussions are relatively brief, but they highlight the attributes of both processes that were of most interest. The sustainment discussion lays out what we think the joint supply system should look like and then compares each of the major segments of that process with what transpired in OIF.

Mobilization

Army mobilization doctrine and processes were designed to generate forces for large-scale operations. However, the OIF mobilizations and the way they came about did not match the Army's expectations; hence, they required adaptations. Moreover, recent mobilizations before OIF had been relatively modest in size and thus did not prepare the Army to deal with issues that arose when the scope of the mobilization increased significantly.

The problems encountered in OIF have led to many important initiatives in the Army that will affect future mobilization planning and operations. Some bear directly on mobilization performance; other initiatives, designed for different purposes, will also affect mobilization. Examples of the former include 100 percent manning of Army Reserve and National Guard units, active and reserve force rebalancing, and the "continuum of service" concept. This latter concept intends to replace the traditional structure of the active and reserve components with a more flexible structure that facilitates seamless movement between varying levels of service throughout a career, based on personal circumstances and the Defense Department's needs at any given time. Modularity, an example of the latter type of initiative, could also place demands on the mobilization process. These were all works in progress in 2004. Improvements in mobilization planning, resourcing, and operations should keep pace with future developments.

Recommendations to Improve Mobilization Capability

OIF mobilizations revealed specific areas for improvement in the design of and the resources devoted to army mobilization:

- **Improved accountability.** The fragmentation of responsibilities for mobilization meant that no single organization was responsible for monitoring the Army's mobilization performance and synchronizing mobilization operations with national strategy and higher authorities' directives and procedures. This situation led to surprises, friction, and false starts. The Army should consider creating systemwide accountability for mobilization and giving a single office responsibility for mobilization process design and performance.
- **Better information systems.** Mobilization information systems affect every stage of mobilization from soldier readiness to unit deployment. OIF mobilizations were hampered by outdated and inadequate information systems. The mobilization community has begun using web-based processes and can continue improving them. Moreover, information systems should be common among active and reserve components and employ standard concepts and definitions.
- **More resources.** Improving information systems requires resources for development and fielding. Major mobilization stations need improved operations centers. Barracks, training, and medical facilities should be held to high standards. Even routine processes such as issuing clothing should be modernized to the standard of 21st century retailing.
- **A new mobilization model.** The Army should reconsider the "mobilize-train-deploy" model. Mobilization planning should not only support major combat operations but also meet the needs of unexpected contingencies and foreseeable rotational deployments. Each type of mobilization calls for a different mobilization concept. For rotational deployments, for example, the Army could consider a "train-mobilize-polish-deploy" model.
- **Use of the Individual Ready Reserve (IRR).** The Army had accurate contact data on only about 65 percent of the soldiers in the IRR. Furthermore, evidence suggests that only about 60 percent of those soldiers could be mobilized successfully. Continuing requests for certain skills from the IRR suggest that authorizations for the active Army understate its requirements. Finally, the IRR played almost no role in the major combat phase of OIF and a relatively minor role immediately thereafter, even taking into account the increase in numbers being requested. That said, the issues of being able to contact personnel in the IRR, knowing their deployability status, and identifying mismatches between the skills the Army wants and those that the IRR has all deserve attention.

In sum, the Army needs a robust, well-managed, and effective mobilization process appropriate to the 21st century security environment. Such a system, with

accountability clearly assigned, would be able to respond to top-down guidance and changing requirements. As a result, the Army would be better able to meet combatant commanders' requirements for Army capabilities when and where they are needed.

Deployment

The deployment of forces to the region differed greatly from that of DESERT STORM. Indeed, in some ways the deployment was explicitly designed not to be another DESERT STORM. That operation involved a lengthy buildup of men, machines, and materiel that lasted six months. Planners rejected that approach in OIF for reasons both tactical and practical. Tactically, they believed that Saddam might reasonably expect coalition forces to repeat what they had done in DESERT STORM and shape his plans accordingly. Practically, there was far less need to follow a deliberate buildup model. The United States had established a large force presence in the region, and it had been able to move additional forces into the region quietly. For example, by December 2002, there were some 60,000 U.S. troops and 400 aircraft based in the region, including combat forces. Furthermore, the Iraqi army was a shadow of its former self (and its former self had been unable to mount a serious challenge to coalition forces in DESERT STORM). Finally, the United States had improved its ability to deploy forces.

The deployment of forces to the Gulf used what was known as the Request for Forces (RFF) process. While more agile than traditional deployment procedures, the RFF system had disadvantages as well. One was that it required approval of each force package, which opened it to micromanagement at multiple levels. Final approval of each RFF was at the Secretary or Deputy Secretary of Defense level. The RFF could be approved, modified, or denied. Secretary of Defense Rumsfeld claimed that the use of the RFF system was necessary to help the President align the diplomatic and military roads to war. However, the RFF system did not mesh well with the plans and expectations of units anticipating a different set of deployment procedures. This was particularly true of the reserve components (RC), whose mobilization procedures involved a series of preplanned steps and an expected timeline. As a result of the time consumed as well as the procedural complexity associated with bringing a reservist onto active duty, many RC members did not show up at the right time or in the correct order, and some members who were called up were not used.

Furthermore, some evidence suggests that the RFF process had some negative operational effects. While the leadership generally understood well the composition of and rationale for traditional combat units (brigades, battalions, etc.), the same did not necessarily apply to logistics units, which tended to be requested piecemeal. Thus, when the need for a truck unit was questioned, it was difficult to justify in terms of effects on overall combat capabilities. For instance, a brigade of the 3rd Infantry Divi-

sion requested 14 five-ton tractors with trailers to move spare parts; packaged petroleum, oil, and lubrication products, as well as food and bottled water; 12 palletized load systems (PLS) to move ammunition; and five 3,000-gallon semitrailer mounted fabric tanks to carry water.¹ Only two five-ton trucks were approved. The section on sustainment discusses the effect that a shortage of trucks had on logistics operations.

Although the deployment for OIF was much smaller than that of DESERT STORM, it still involved a large number of forces. About 250,000 U.S. forces deployed to the region along with about 50,000 from coalition partners. The RC contributed heavily. The U.S. Army National Guard and Reserve activated 148,612 members; the Naval Reserve, 9,875 members; the Air National Guard and Air Force Reserve, 30,783 members; and the Marine Corps Reserve, 19,711 members.² Not all of these forces deployed to the Gulf region.

Sustainment³

The rapid advance of U.S. armored forces that toppled Saddam Hussein's regime was made possible by a robust fuel supply and distribution system and a leaner system for other supply categories that proved adequate but operated on the edge. Strategic planning for OIF was predicated on the application of a new support concept called Distribution Based Logistics (DBL). In contrast to the logistics operations of the first Gulf War, DBL does not call for an initial buildup of large stockpiles in the theater of operations. Instead, it uses much smaller stockpiles and relies more on the rapid and reliable delivery of supplies. Overall, the new support concept worked. That said, for all classes of supply other than fuel, problems occurred. And in one critical class of supply—spare parts—the supply and distribution system failed at some times for some units.

Logistics problems in OIF occurred both during the major combat operations and for some time during post-combat operations. Among these were distribution problems, including brief disruptions, and shortfalls in the national supply of some items. At various times, these logistical problems increased risk, affected quality of life, and affected equipment readiness, but not, so far as we could document, to the point of impeding operations.

¹ Eric Peltz, John M. Halliday, Marc L. Robbins, and Kenneth J. Girardini, *Sustainment of Army Forces in Operation Iraqi Freedom: Battlefield Logistics and Effects on Operations*, Santa Monica, CA: RAND Corporation, MG-344-A, 2006, p. 21.

² "U.S. Reserve Force Now More Than 200,000," United Press International, March 19, 2003.

³ More detailed accounts of logistics operations in OIF appear in Eric Peltz et al., *Sustainment of Army Forces in Operation Iraqi Freedom: Battlefield Logistics and Effects on Operations*, Santa Monica, CA: RAND Corporation, MG-344-A, 2006, and Eric Peltz et al., *Sustainment of Army Forces in Operation Iraqi Freedom: Major Findings and Recommendations*, Santa Monica, CA: RAND Corporation, MG-342-A, 2006.

The reasons for the problems are varied and complex. Some occurred because the Army and its strategic distribution partners (specifically United States Transportation Command and the Defense Logistics Agency) had not completed their joint transition to the DBL concept. Other issues existed separate from that concept and would have been issues regardless of the support concept chosen, especially in the face of the unforeseen scale, duration, and intensity of the counterinsurgency operation that developed after the fall of Saddam. Finally, commanders decided to accept some logistical risk to achieve operational surprise.

Resupply During Combat Operations

The key measure of success for a logistics system is whether it was able to support combat operations. By that measure, the logistics system for OIF succeeded. It provided the food, fuel, and ammunition necessary to support the operation. Perhaps the weakest part of the logistics process was provision of spare parts, but even that did not limit operations.

The 3rd Infantry Division's plan was to cross the line of departure with five days of supply of food and water in organizational trucks and trailers, with an additional one to two days of supply in support units. The plan was to get the first resupply on G+2 from corps at Objective RAMS in the vicinity of An Najaf, with distribution flowing from that point on, keeping the division basically at or close to the initial full load of supplies.⁴ As a result of the sandstorm, the congested roads, the two-day early start of the operation, and other factors discussed in the distribution section below, the first replenishment of food and water, along with limited quantities of other materiel, did not arrive until G+6.⁵ At this point, some units were down to a day or less of supplies, reporting "black" on supply status (officially less than 50 percent). In particular, the 3rd Squadron, 7th Cavalry Regiment (3-7 CAV) was down to one day or less.⁶ 1st Brigade, 3rd Infantry Division (1/3 ID) was fairly low as well. But not all units were in this precarious shape. Again, some had taken more than the official planned level, and food was often consumed at less than the planning rate.⁷ Some of the difference among units had to do with available preparation time. For example, soldiers of the 2/3 ID, which had been there for several months, had time to install additional racks on their vehicles to hold more supplies.⁸ 2nd BCT reported between 2.5 and 4 days of food remaining at the time the first sustainment push arrived, with unofficial stowage and low Meal, Ready-to-Eat (MRE) consumption the driving factors for the relatively

⁴ Interview with Lieutenant Colonel Steve Lyons.

⁵ Interview with Lieutenant Colonel Steve Lyons.

⁶ Interviews at 3-7 CAV and 3rd ID DISCOM.

⁷ Interview with Major Glenn Baca, formerly division transportation officer, October 28, 2003.

⁸ Interviews at 3rd ID DISCOM.

healthy on-hand level.⁹ Some Army units did report having to “officially” go to two meals per day for three to four days from about G+6 to G+10.¹⁰

Early on March 26, the 19th Support Center (SC) reported a commander’s assessment that 3rd Infantry Division was black on ammunition and red on food and water along with the 101st Airborne Division (Air Assault).¹¹ (This is a marked change from detailed 19th SC supply status reports on the 25th that show 3rd Infantry Division green in all areas of supply except packaged POL products—amber—and green for the 101st across the board.)¹² The 19th SC’s situation report stated that supplies were en route but delayed by the weather. They expected to see dramatic improvement as the storm lifted and en route supplies began reaching their destinations. Because of the storm and the other factors discussed, the first push of supplies that left on March 23 did not reach Objective RAMS until the 26th and then had to be distributed to the 3rd Infantry Division’s BCTs and other units. At that time two more days were already en route, and another two days’ worth was to depart on the following day.¹³

Interviews revealed that water was a bigger concern than food. In fact, both the 1st and 2nd BCTs of 3rd Infantry Division listed water and spare parts as the top two problems, with spare parts being worse in the 1st BCT.¹⁴ The plan was to launch the advance to cordon Baghdad with robust quantities of food, water, and other supplies available in units and at forward LSAs. The original concern was that from that point forward, supply lines would be at high risk, so immediate resupply could not be counted upon. It was Lieutenant General Wallace’s intent not to launch into the Karbala Gap toward Baghdad until they had established LSA Bushmaster at Objective RAMS and it could support the advance.¹⁵ On March 27, the 19th SC situation report stated that they were trying to meet the corps commander’s guidance to build up a five-day supply of food and water in all units in Iraq, with two additional days at LSA Bushmaster.¹⁶ However, many sources report the perception that distribution capacity was insufficient to rebuild supplies back to the five-day level. For example, maneuver units in the 3rd Infantry Division reported beginning to get sustainment

⁹ Interviews at 2/3 ID.

¹⁰ Interview with Lieutenant Colonel Craig Finley.

¹¹ The 19th Support Center’s supply status reports indicate “green” as no impact on operations, “amber” as potential minor impact, “red” as potential for major impact, and “black” as potential for mission failure. Its situation reports describe these levels as 85–100 percent of requirements, 70–84 percent, 50–69 percent, and less than 50 percent, respectively.

¹² 19th Support Center Class of Supply—ORG/DS Readiness Report, 251530ZMAR03.

¹³ 19th Support Center situation report (SITREP), 261100ZMAR03.

¹⁴ Interviews with Lieutenant Colonel Willie Williams and Colonel William Grimsley.

¹⁵ Interview with Lieutenant General William Wallace, formerly commanding general of V Corps, Fort Leavenworth, KS, April 6, 2004.

¹⁶ 19th Support Center SITREP, 271100ZMAR03.

flows at barely sufficient levels to keep them going, let alone build their supplies back up, generally keeping them at 1+ days of supply. These reports are consistent with the days-of-supply status for food, water, and fuel for 1/3 ID shown in Table 9.1¹⁷ and sustainer push reports from the 3rd Corps Support Command (COSCOM). The first push with two days worth of supplies arrived on March 26 (delayed two or three days by the storm and other factors limiting road throughput), but an additional two days of supply was en route for delivery on the 27th with another two days' worth scheduled for departure on the 27th for 29th delivery.¹⁸ This pattern continued with two-day pushes departing every other day, except for the 29th, which had a four-day push.

However, most of the convoys were short some trucks, reducing the convoy loads from the full two days of supply.¹⁹ Additionally, it does not seem that this resupply pattern became immediately clear to 3rd Infantry Division personnel. With limited in-transit visibility at their level, supplies seemed to just show up. This uncertainty dramatically increased the perceived level of risk. Snapshots of the direct support (DS) on-hand levels at LSA Bushmaster were archived for a small number of days. They suggest that DS food supply was built up to the target level of two days, but bottled water supplies were thin. Table 9.2 shows all snapshots available. These are from the 3rd COSCOM daily commander update briefings. The briefings themselves have been archived for each day during combat operations, but they include the information shown in the table for only a limited number of days.

We do note that the 3rd COSCOM's daily briefings indicate different supply levels of food and water in 3rd Infantry Division than suggested by 1/3 ID's supply status reports—four to five days of supply on April 4 and 5 for the division.²⁰ This may reflect the amount of materiel at division level or en route to brigade combat teams as

Table 9.1
Days of Supply On Hand, 1st BCT Orange 1 Reports

Date	March 29	March 30	March 31	April 1	April 6	April 7	April 8	April 9
MREs	1.6	1.9	1.9	1.8	1.8	1.5	1.5	1.8
Water	0.8	1.0	1.2	1.0	1.0	0.9	0.9	0.8
JP 8 fuel	1.0	4.3	4.7	3.9	3.1	4.1	3.6	2.3

NOTE: All available reports from March 20 to April 10 listed.

¹⁷ Interviews at 1/3 ID with Colonel William Grimsley, commander; Lieutenant Colonel Ernest Marcone, commander TF 3-69 AR; and focus group of battalion XOs, brigade XO, battalion motor officers, BN S-4s, and battalion maintenance technicians. 1st BCT daily Orange 1 supply status reports.

¹⁸ 19th Support Center SITREP, 261100MAR03.

¹⁹ 3rd COSCOM daily commander update briefings, April 3 and 5, 2004.

²⁰ This level of supplies differs from what the 3rd Infantry Division reported: one to two days of supplies.

opposed to the brigade-level view reflected in BCT supply status reports, since corps throughput was to the division support area and not directly to brigades. Table 9.2 includes on-hand days of supply of MREs, bottled water, and bulk water along with bulk fuel and ammunition status and lists of critical items, petroleum products, and spare part supply items as shown in daily 3rd COSCOM briefings.

What the combination of limited situation reports, commander's update briefings, and brigade supply reports and interviews shows is that the intent was to return supplies in divisional and other major units to the original line of departure level, with two days of DS backup at LSA Bushmaster. For food it appears this goal was almost achieved, if the supplies in the division support area (DSA) are combined with the supplies available in BCTs, but limited distribution capability from the DSA forward to units did not make it appear that way to front-line maneuver units. Water remained scarcer, even as the daily requirement was reduced from six bottles per person to three

Table 9.2
Days of Supply On Hand as Reported in 3rd COSCOM Commander's Daily Update Briefings

		April 4	April 5	April 10
3rd ID	MRE	4	5	1.8
	Bottled	4	5	1
	Bulk	1	1	1
	IIIB	G	G	G
	V	G	G	G
	Critical	Dextron III Turboshaft BATT (5590)	Dextron III Turboshaft BATT (5590)	
82nd	MRE	3	2	3
	Bottled	2	2	1.5
	Bulk	0	0	0
	IIIB	G	G	G
	V	G	G	G
	Critical	Dextron Turboshaft	Dextron Turboshaft 105mm HERA HELLFIRES	
101st	MRE	2.1	3.1	5
	Bottled	5	6	5
	Bulk	0	0	1
	IIIB	G	G	G
	V	G	G	G
	Critical	BATT (5590)	BATT (5590)	

NOTE: G = Green supply status. Dextron is fluid for power steering systems; turboshfts are parts for M-1 tanks; 105mm HERA is ammunition (high explosive, rocket assisted) for an M-1 tank; and BATT 5590 refers to lithium batteries used in radios.

per person after setting up LSA Bushmaster and establishing the ability to supplement bottled water with bulk water.²¹ The result is that overall reports reaching the corps commander level likely indicated a stabilizing and sufficient supply situation with respect to the commander's intent to advance forward through the Karbala Gap toward Baghdad; nevertheless, these reports remained interspersed with reports of local shortages.

Ammunition support during combat operations is more problematic in general, because compared with food and water, consumption of ammunition is much more variable and unpredictable and resupply determination is more complex, depending upon the type of ammunition needed. Additionally, the need for ammunition resupply can be immediate, without warning, and develop while in contact. Critical, spot shortages requiring immediate, emergency resupply are more likely to develop for ammunition than for other supply classes, and they did in OIF; furthermore, shortages can develop in difficult resupply situations. But a general, overall shortage did not develop, in terms of not having at least some ammunition available to achieve the desired effects, even if not by means of the preferred munitions.²²

For example, division artillery struggled at times with shortages but invariably found ways to get resupplied. However, its units often did not have the types of fuses and munitions that were deemed optimal. And deliveries were made in bulk, requiring the artillerymen to break them into combat-configured loads for distribution to units. Such issues could have created problems in some situations. However, the artillery commander and staff reported that there were no cases where its battalions could not achieve the desired combat effects.²³ Still, there were times when they produced collateral, undesirable effects, such as when they would have preferred to use high-explosive munitions to cut down on duds but had no choice other than to use dual purpose improved conventional munitions (DPICM) instead of conventional high-explosive shells.²⁴

In contrast to some other classes of supply, fuel supplies were robust. Actions and interviews across all levels lead to the conclusion that the chain of command considered it of paramount importance for the success of the operation to get fuel supply and

²¹ 3rd COSCOM, Commander's daily update briefings; 1st BCT supply status reports, 2004.

²² Interview with Blount; interview with Brigadier General Charles Fletcher, former commanding general of 3rd COSCOM, October 22, 2003.

²³ Interviews with Lieutenant Colonel Craig Finley (commander, 1/39 Field Artillery Battalion MLRS), Major Phil Rice (Ops, 1/9), Major Jim Rooker (assistant S-3), Major Benigno (S-3, 1/39), Sergeant Pichardo, Captain Miguel Garcia (S-4), Major Barren (2nd Brigade fire support officer), Major Ken Patterson (current executive officer), Colonel Thomas Torrance (commander), 3rd Infantry Division, Division Artillery, October 28, 2003. Interviews with Captain Jeff Sabatini (A/S-4 Maint and S&S), First Lieutenant Adam Points (battle captain), and focus group, 2/3 Infantry Division, October 29, 2003. Interviews with Captain Patrick Shea, First Lieutenant Keith Miller, and Captain David Muhlenkamp, 3-7 CAV, October 29, 2003.

²⁴ Interview with Colonel Thomas Torrance, 3rd Infantry Division, Division Artillery, 2003.

distribution right. The speed of advance was considered critical to the operational plan, and adequate fuel was essential to a rapid advance. Unlike some other classes of supply, fuel shortages cannot be temporarily worked around, and fuel cannot be rationed without affecting the operational plan. Perhaps, too, experience from World War II to DESERT STORM drove the intense focus on fuel, since it has historically been the most common problem whenever logistics has constrained mechanized operations.

As a result, a strong emphasis was placed on ensuring that the force would have robust fuel resupply capabilities, which affected the amount of time spent planning and rehearsing fuel resupply operations and the priority given to fuel supply and distribution resources. Lieutenant General Wallace stated:

We may have spent more time and energy on fuel at the expense of other commodities in hindsight that we might have anticipated being problems, but we just didn't have the same energy applied to it. . . . We knew we were going to have fuel problems, and thus we spent a lot of time and energy trying to solve those problems . . . and . . . as a result we didn't have any fuel problems.²⁵

However, beyond the recognized importance of getting the supply and distribution of fuel right, other factors unique to fuel supply and distribution were important as well. These included the early establishment of fuel “farms”—fuel storage sites—in northern Kuwait and moving the Inland Petroleum Distribution System (IPDS) from Army prepositioned stocks (APS) in Qatar to Kuwait by January 2003.²⁶ Between the IPDS and pipeline construction by the Kuwait National Oil Company, pipelines connected Kuwaiti refineries directly to the fuel farms and led virtually to the border with Iraq, with the fuel infrastructure complete by March 2003.²⁷ The total system could store 7.3 million gallons of fuel by the start of combat operations, and most storage sites possessed fuel stocks close to capacity.

The Pause in the Advance at Objective RAMS

Various reasons have been offered for the pause that was ordered a few days after the advance began, including supply shortages in V Corps. Thus, we examined whether sustainment problems did indeed cause the pause.

By March 23, 2nd BCT of the 3rd Infantry Division had secured Objective RAMS just south of An Najaf, and 1st BCT moved north of RAMS to Objective RAIDERS (see Figure 9.1). However, the 3rd BCT had to counter unexpectedly heavy resistance in As Samawah that had been interdicting the main supply route and then

²⁵ Interview with Wallace, 2004.

²⁶ Major Thomas Murphree, TDC commander (and previously CFLCC C-4 battle captain), interview with the author, May 26, 2004.

²⁷ Fontenot, Degen, and Tohn.

Figure 9.1
Major V Corps Routes of Advance, Objectives, and Logistics Support Areas

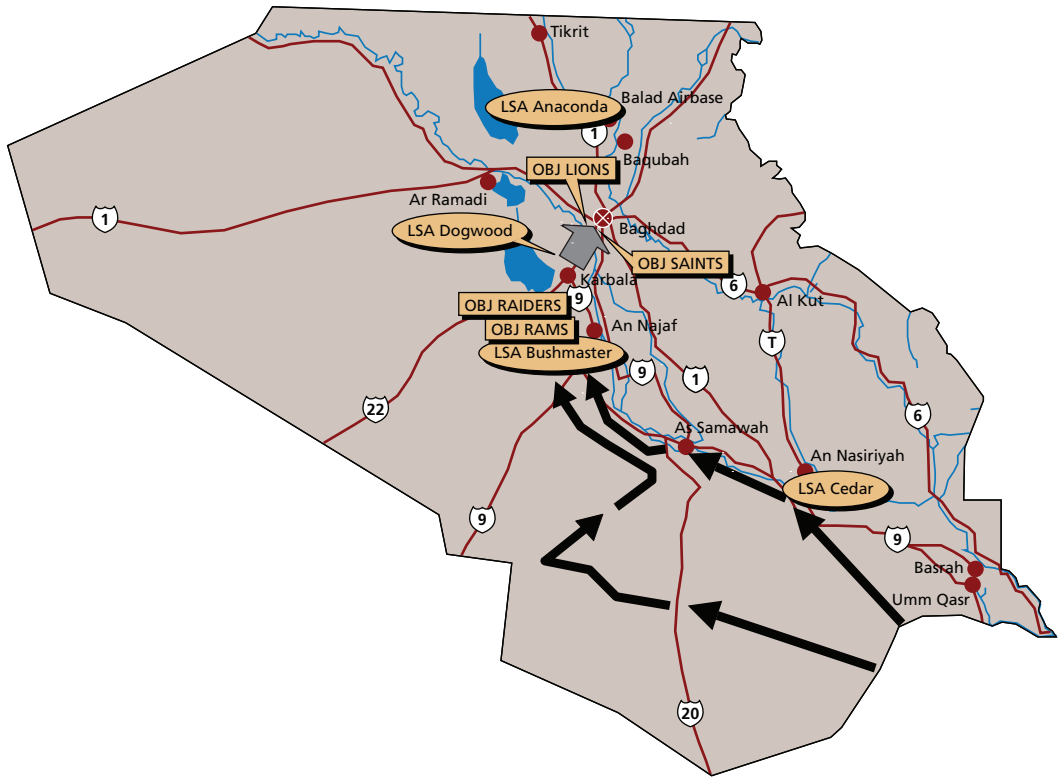

RAND MG641-9.1

remained there to protect the LOCs. On March 24 began the “Mother of All Storms,” a sandstorm that limited offensive and other operations through the 26th. During this time, 1st BCT, 2nd BCT, and 3-7 CAV were engaged with enemy forces in the vicinity of An Najaf, which, it was realized, could not be bypassed without incurring undue supply line risk. Similarly, the continued, unexpected resistance by Fedayeen along the supply lines led to a change in plans. The route from Kuwait to An Najaf could not be left unprotected. However, with the rolling start to the operation that limited available forces when operations commenced, no combat forces had been following the 3rd Infantry Division to secure the rear areas; this was a risk that had been accepted. Thus, the 3/3 ID stayed back to secure critical areas near As Samawah. To enable the 3rd Infantry Division to be at full strength for the assault toward Baghdad, plans had to be quickly developed for its relief. Similarly, the Fedayeen operating from An Najaf posed too much of a threat for the 3rd Infantry Division to continue its advance without another force securing LSA Bushmaster and the supply lines in this area.

Plans were modified to relieve the 3rd Infantry Division as soon as possible. The 2nd BCT of the 82nd Airborne Division was released to V Corps on March 26, and it completed its relief of 3/3 ID on March 29. Plans for the 101st Airborne Division (Air Assault) were changed, and it too was assigned to relieve the 3rd Infantry Division of LOC security roles. Responsibility for eliminating the threat from irregular forces in An Najaf was also given to the 101st, which completed its move to the city by the 30th.²⁸ This series of actions enabled the 3rd BCT to move north, rejoining the 1st and 2nd BCTs and allowing the entire division to prepare to restart the offensive before first light on March 31. During this time, airpower worked to destroy the Medina Republican Guard division and other forces south of Baghdad, setting the conditions for the advance.²⁹

Because of the limited distribution capacity and competing demands for the assets, the COSCOM was not able to establish significant stockpiles at LSA Bushmaster. However, the pause in the advance still may have helped the logistics system become somewhat better prepared for further offensive operations. It most likely enabled the distribution system to stabilize after the initial advance and kept the supply lines and thus round-trip times from getting even longer. Every day until the advance resumed was another day for trucks to become available for use as units continued to download their equipment from ships and prepare for operations at camps in Kuwait. From March 19 to April 1, the 3rd COSCOM's available trucks increased by 63 percent. So while the units and Bushmaster did not fully achieve their desired levels of days of supply for food and water, the pipeline from Kuwait north began to approach desired levels of supply and, by this time, could maintain a large-enough volume of distribution flow to keep up with consumption (but not enough to build stockpiles or replenish initial unit inventory levels).

The pause was not caused by a need to build up stockpiles, although it may have helped the distribution system to stabilize and improve its organization. However, one of the key proximate causes was the need to secure the supply lines to enable continued sustainment and even more extended LOCs. In this sense, beyond any shortfalls in combat service support units themselves, sustaining the force required much greater resources than anticipated: more than an entire division to secure the supply lines from Kuwait through An Najaf.

Additionally, this was certainly not a pause in combat, as should be clear from the descriptions of the operation from March 24 to March 27. The words of Lieutenant General McKiernan, the CFLCC commanding general, are stronger. He said: "I would refute any notion that there was any kind of operational pause in this campaign. There was never a day, there was never a moment where there was not continuous pres-

²⁸ Fontenot, Degen, and Tohn.

²⁹ 3rd Infantry Division (Mechanized).

sure put on the regime of Saddam.”³⁰ The protection of the LOCs marked a shift in the nature of the operation and in the understanding of the enemy. Rather than the anticipated battles with capable Iraqi armored divisions, the Army had to contend with irregular forces throughout much of the country.

While supply line security remained a concern throughout the operation, the subject came into play as a major issue again in April 2004. As the insurgency grew in strength, some supply routes had to be temporarily cut off until they could be resecured.

Supply Chain Performance in Operation IRAQI FREEDOM

The system used to keep supplies flowing to combat units is a series of interlinked processes and organizations. All must work together smoothly to keep units supplied. This chapter offers some insights into the performance of that system in OIF and makes some recommendations about how to improve the system with regard to:

- Tactical supply operations
- Theater distribution
- Strategic distribution
- National-level supply
- The overall logistics system.

Figure 9.2 lays out a schematic of the joint supply chain with descriptions of the integrating, ideal roles and capabilities of the various components based upon Distribution Based Logistics. The resulting vision that is described focuses primarily on meeting the readiness needs of units in the field and secondarily on doing this as efficiently as possible. The figure shows the major elements of the supply chain vision, with the tactical level on the right and the national level on the left. Distinguishing characteristics and roles of each element appear in lighter text. Our assessment is based upon a comparison of this vision to how the supply chain actually worked and was structured for OIF.

This vision was not entirely new to the U.S. military organizations that conducted and supported OIF. Many had been working toward portions of it. Yet not every link in the supply chain was designed and tested in accordance with the vision, and even when the design was in place, actual policies and practices did not fully accord with it, or in some cases the policies and practices were not kept in synchronization with the transition to war. Finally, not all of the equipment and information systems needed to execute the vision fully had been fielded. This was especially the case with command and control systems for logistics situational awareness.

³⁰ Lieutenant General David McKiernan, “Operation Iraqi Freedom,” U.S. Department of Defense press briefing, Baghdad, Iraq, April 23, 2003.

Figure 9.2
A Readiness Focused Supply Chain

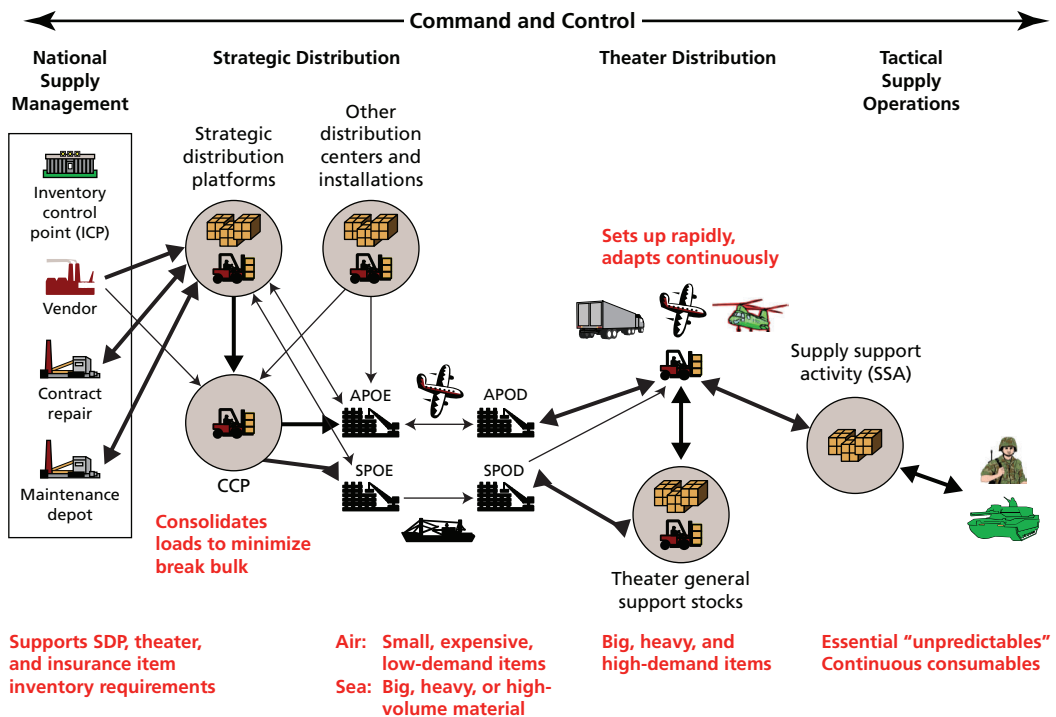

RAND MG641-9.2

Tactical Supply Operations

The right side of Figure 9.2 depicts the generation of demands by tactical units and the supply elements (called supply support activities (SSAs)) that travel with them and carry the critical supplies these units need upon demand during the course of operations to remain effective. For reasons of strategic and tactical mobility, the Army limits the amount of supplies that units carry to those absolutely needed to remain ready to operate. This constraint, along with the capabilities of the rest of the system, has implications for both the range and quantities of items stored. Units should only carry items they need immediately when demanded or that they need continuously. These include spare parts critical to readiness, food, water, fuel, medical supplies, ammunition, lubricants, limited materiel for building defensive positions, and other basic subsistence items. This list does not include items that units can wait for, such as clothing or nonessential spares, or items whose use can be scheduled in advance, such as armored vehicle tracks for full track replacement at regular intervals.

From a quantity standpoint, the aim at this tactical level should be to have enough of each stocked item to avoid running out under realistic assumptions, which includes a safety margin to hedge against uncertainty. The quantity needed varies substantially

among commodities, depending upon demand variability and other factors. For example, it is safe to assume that each person will eat a specified number of meals each day, so the system can “push” supplies to cover expected consumption on a regular basis, greatly limiting the amount of food that units must carry.

In contrast, demand for some spare parts varies tremendously, and there are literally tens of thousands of different parts that a maneuver brigade might need. It is possible to make reasonable predictions about what parts will be needed across units and establish a range of possibilities, but it is not possible to make precise forecasts of what each unit will order in a short period of combat. Thus, spare parts should not be sent forward until equipment failures create a “pull” on the supply chain, with a unit specifically requesting them based upon maintenance or inventory replenishment needs, and units need to carry enough of these items to cover demands up to a desired level (e.g., what is the likely range of demand quantities during an intense week of combat, and what portion of that range does the Army want to cover?).

In actual operations, such as those in OIF, the problem is often less one of determining the minimum amount of supplies and storage capacity needed than one of using relatively fixed carrying capacity effectively. Unless augmentation is available, each unit must be able to carry its supplies on its own vehicles. So, in general, this trade-off between readiness and the transportation assets needed to move supplies must be well treated in the force design process to determine the “right” level of lift capacity given to a unit to move its own supplies. The tradeoff must also be considered in the deployment planning process if the operation is not of the sort for which a unit was designed, which could require augmentation. For example, if a plan calls for the first resupply after five days and the unit can carry only three days of supplies, it will need additional trucks and trailers.

In the Army during OIF, the spare parts selected and then authorized to be stocked form what is called the authorized stockage list or ASL. While nominally a list of items authorized for stock along with the authorized quantities (known as requirements objectives or ROs) and reorder points (ROP), the physical inventory itself is typically also called an ASL in the Army. Each maneuver brigade has an SSA assigned to it that manages and operates an ASL “warehouse,” typically in the form of trucks, trailers, and containers that ideally have well-laid-out storage aids such as cabinets to maximize their utility. The parts are selected to support the brigade as effectively as possible within the storage constraints of this mobile warehouse.

In OIF, all units in the Army received their primary direct spare parts support from an SSA. When organizations task organize as they did in OIF,³¹ however, the supporting SSA can change, which poses a problem if the new SSA did not previously

³¹ As the name implies, task organizing means bringing selected units together to accomplish a specific task, after which the organization dissolves. A typical task organization involves mixing tanks and Bradleys, which are normally in separate units.

support any units with similar equipment and thus does not have the requisite spare parts.

Tactical Supply Operations in OIF

In OIF, SSA stocks were quickly depleted, whether to a home-station, deployed, or prepositioned ASL. This occurred for three reasons: (1) the Army did not stock home-station ASLs to wartime operating tempo; (2) it did not stock to cover the long replenishment wait times that developed from distribution problems; and (3) supply disruptions occurred during the operation (see discussion below). Additionally, for prepositioned SSAs, drawn by the 3rd Infantry Division with equipment stored aboard ships and in Southwest Asia, the mix of parts did not match the equipment well, i.e., some of the parts they had were not the ones needed, and many of the needed critical parts were not there at all.

The text box (see right) explains some basic metrics and terms the Army uses in its inventory practices. Those familiar with them should skip over them.

Rapid Depletion of On-Hand Parts.

Many demands for spare parts were unmet in OIF, even when the right parts had been authorized for stockage, because the supplies of these parts were quickly depleted. The key is that the demand levels for some parts were much higher than those experienced at home during training events, and the replenishment times were longer, because the Army's home-station ASL depths were computed based upon home station demands and replenishment times along with mobility and cost constraints. It took twice as long (or longer) to get a replacement part during OIF than it did at home station, and some shipments were misdirected and never delivered to the ordering unit. The depleted shelves drove satisfaction rates for ASLs to very low levels, such as from 65 percent at home for the 101st Airborne Division to just 20 percent in the early months of OIF, as seen in Figure 9.3.

The result was that when the fill rates became extremely low, an ASL con-

Some Basic Army Inventory Metrics and Terms

To evaluate the effectiveness of tactical inventories and help diagnose the sources of any shortfalls in performance, several metrics are useful: accommodation, satisfaction, and fill rates. We use a simple example to explain their meanings.

- **Accommodation.** Suppose you go to the auto parts store for ten different parts. You search the shelves and talk to a clerk and find out the store only carries six of them. Each of those six has a dedicated shelf space. The other four items always must be ordered from a national warehouse. The accommodation "rate" is thus 60 percent or 6 of 10. Accommodation measures the quality of the breadth of inventory requirements: Are the "right" items being selected and authorized for stockage?
- **Satisfaction.** When you go to the six different shelves, you find that two of them are empty. The store has run out of two of the six items that you need and they typically carry. Thus, the satisfaction "rate" is 67 percent or 4 of 6. Satisfaction measures the quality of the depth or quantity of each item that is stocked: Are "enough" of the right items being carried to meet critical demands?
- **Fill.** When you leave the store, you leave with 4 of the 10 parts you needed, for a fill "rate" of 40 percent. Fill rate is a total measure of inventory performance.

Figure 9.3
Inventory Performance for Major Army Units

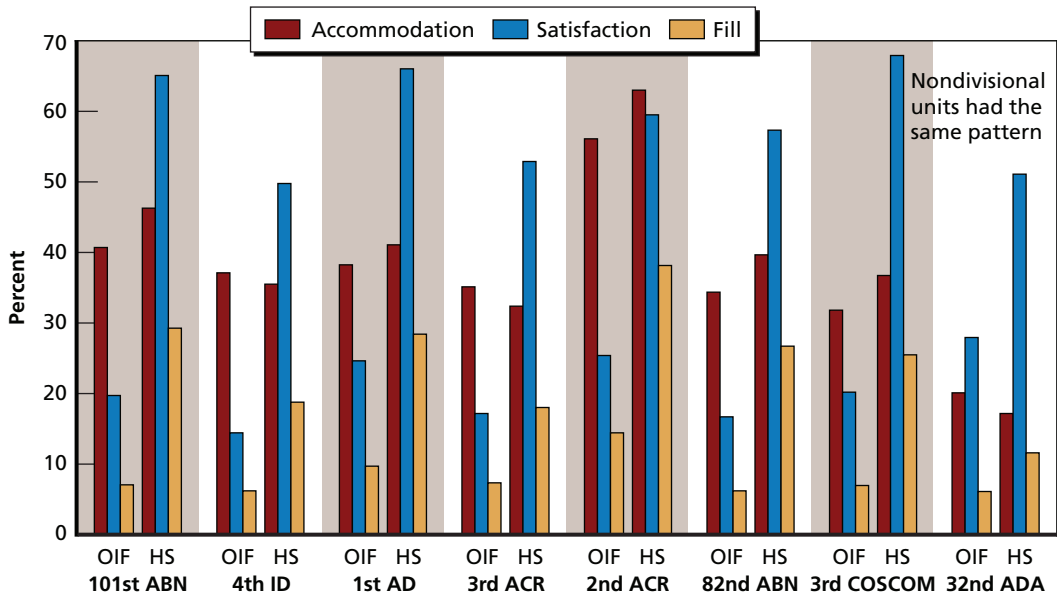

RAND MG641-9.3

tributed little to sustaining equipment readiness. Almost every demand became a pass-through to the national supply base in CONUS, 30 days away by air for significant portions of OIF, assuming the item was still available to ship.

The difference in performance can be explained by the different methodologies and data sources used to develop the APS and home station ASLs. The more critical difference appears to be the input data. APS ASLs were based upon what are called candidate items files that have part-to-end-item mappings and estimated failure rates. Failure rates start as engineering estimates or proxy values, with some updates based upon empirical data. In contrast, home station ASLs are based solely on actual demand patterns for the units supported by an SSA—i.e., what breaks in the field when units are operating the equipment.³² The definition of what is critical or a readiness driver in the APS ASLs is also extremely broad, including many parts that have never kept a system operating in the field from performing its key functions. Additionally, the APS ASL criteria exclude some parts that field experience has shown to be readiness drivers.

Ordering Parts During Major Combat Operations. Units had trouble placing parts orders during major combat operations. Typically, the SSA immediately orders a replenishment part when the reorder point is hit. However, this typically did not occur

³² See Kenneth Girardini et al., *Dollar Cost Banding: A New Algorithm for Computing Inventory Levels for Army SSAs*, Santa Monica, CA: RAND Corporation, MG-128-A, 2004, for an explanation of the Army's ASL determination process and the algorithm employed.

during OIF's major combat operations. Few parts were ordered during this period. This is a concern because any delays before ordering in effect extend the replenishment delays represented by distribution time. It is important to understand the reasons why units were unable to order during major combat operations in OIF so that this problem can be remedied in future contingencies, particularly those with longer major combat periods.

The lack of ordering stems from two issues: creating a request and submitting a requisition. An analogy would be a physician first diagnosing an illness and writing a prescription and then calling it in to the local pharmacy; another analogy is filling out an order on Amazon.com and clicking the send button. Similarly, the first step in ordering a part is for maintenance to diagnose the problem and create a part request, which is sent to the SSA. The red line in Figure 9.4 shows maintenance requests by day for the 1st BCT of the 3rd Infantry Division. Note the relatively heavy activity in February and the first half of March 2003, followed by relatively little activity from the time the unit moved to the border of Iraq in mid-March until the fall of Baghdad in early-to-mid April. Then requests picked up again. Note also the complete absence of ordering for the first few days of combat operations when the BCT was advancing from Kuwait to An Najaf. There was no intent to and basically little feasibility of ordering parts given current maintenance systems during this period of intense activity

Figure 9.4
Maintenance Requests by 1st BCT, 3rd Infantry Division Units and 3rd Forward Support Battalion, 1st BCT, 3rd Infantry Division Requisitions

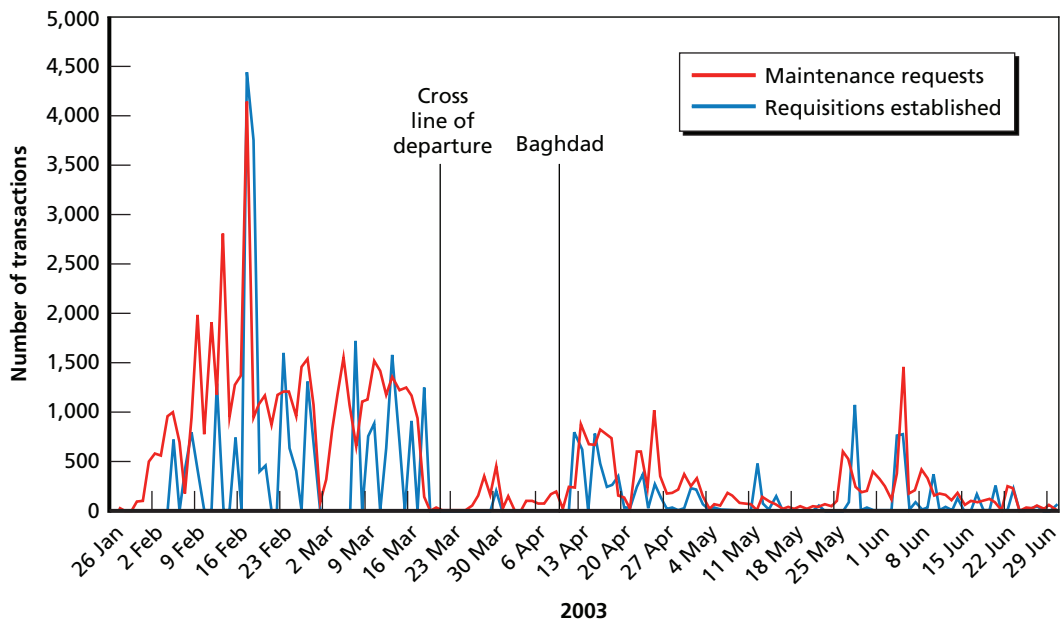

with nearly constant movement. Ordering picked up somewhat for a few days as the advance, but not combat, paused from March 24 to March 30. The conditions limited ordering to only the most critical requests, far below what might be ordered in a more garrison-like environment. Then requests slowed again as the brigade maneuvered and fought from Karbala to Baghdad.

Now note the blue line, which reflects daily requisitions submitted from the SSA to the remainder of the supply chain. It reflects a nearly total blackout of non-line-of-sight communications capability for SSA supply systems during major combat operations. Lacking mobile satellite communications, the 3rd Infantry Division and other units could not electronically order parts on a distributed battlefield with extended supply lines and frequent movement.

Prepositioned Parts Did Not Match Demands Well. To accelerate deployment, the Army used prepositioned equipment for most of the 3rd Infantry Division. The division's three BCTs drew complete sets of brigade equipment that had been stored either on ships or in Southwest Asia. This equipment also included ASLs with parts matched to the equipment. Beyond the replenishment problems that drained all SSAs, the three prepositioned ASLs also did not perform very well in terms of having the parts the units needed to repair equipment. The one ASL of the three that had been used for rotational training did better than the other two that had never been exercised. In this report, we concentrate on the latter two, using the 3rd BCT in the example below to illustrate the performance.

The equipment drawn by the 3rd Infantry Division was generally the same as what it had at home station. However, the home station ASLs had little in common with the prepositioned ones (APS). They were developed with different methodologies and using different data.

With records of the parts that the 3rd BCT demanded in OIF, we used the data to predict how well different ASLs would have met the demand. What we discovered was that the part mixes for the prepositioned ASLs were not well selected for the prepositioned equipment. Figure 9.5 compares the predicted performance of the required APS ASL drawn by the 203rd Forward Support Battalion (FSB) (the unit that typically supports the 3rd BCT), the actual ASL that the brigade drew in Iraq, and its home station ASL. The left-hand set of bars shows that the predicted accommodation percentage for the home station ASL is 20 points higher than for the APS ASL requirements when considering all spare part requests. The right-hand set shows a similar difference when limiting the population of requests to parts critical to readiness, with the performance of both ASLs higher in this set—as they should be according to the model supply chain.³³ The right-most column in each set of three shows how the actual

³³ Readiness drivers are those parts that maintainers must replace to restore a broken vehicle or weapon system, such as a tank, to mission capable condition. Specifically, they are defined in this research as a list of parts generated from an archive of daily deadline reports, commonly called “O26” prints, submitted by active Army units.

Figure 9.5
Comparing Accommodation for the 203rd FSB's APS and Home Station ASLs

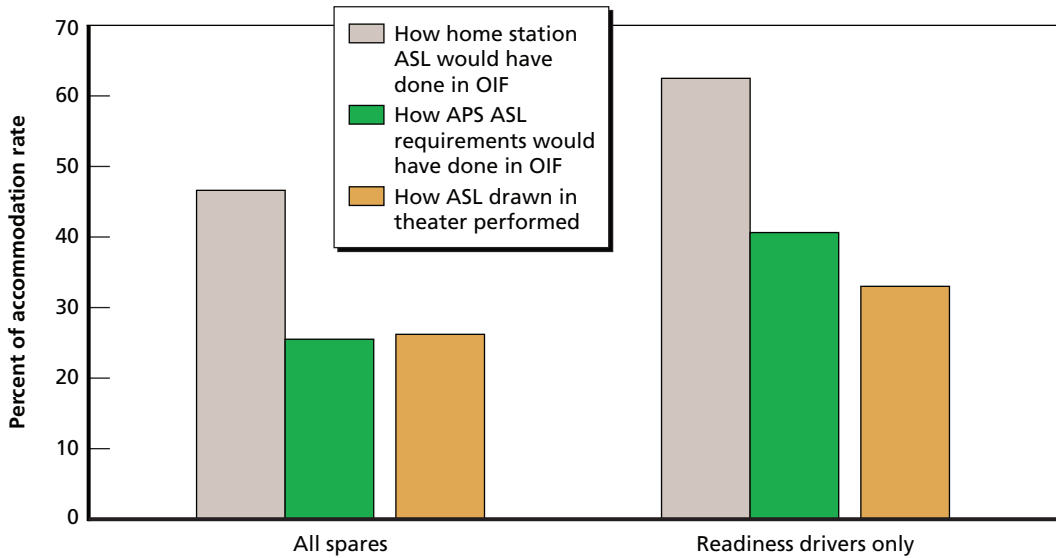

RAND MG641-9.5

APS ASL performed. The APS ASL only accommodated about 25 percent of all spare part requests and, more important, only about one-third of requests for parts critical to readiness. Additionally, about two-thirds of the required and actual APS ASL parts were not demanded in OIF by the 3rd BCT. In contrast, this proportion is about one-third for the home station ASL.

Theater Distribution

Shown to the left of the tactical supply operations in Figure 9.2, the theater distribution system links national suppliers and centralized theater inventory to units in the field. Developing and managing theater distribution are complex operations. For a contingency operation, the theater distribution system often must start from scratch and continually adjust to the number, type, and location of forces supported as well as to the varying needs that arise in different phases of an operation. This requires a well-planned and flexible choreography to maintain adequate distribution capacity, balanced across echelons, to keep supplies flowing reliably. To avoid developing early backlogs and shortages that can be difficult to recover from, the setup of the theater distribution system must be rapid, with the requisite units and resources carefully phased into the deployment flow. Reliable flows also require adequate security for supply lines and logistics units, which has relatively large implications for tactical support unit resource needs and total operational force requirements.

Theater Distribution in OIF

In OIF, a confluence of factors made cargo truck capacity inadequate during major combat operations, especially at the outset. Inadequate truck capacity resulted from problems on the supply and demand side of the equation. On the one hand, fewer trucks were provided than were requested, arrived later than needed, or had their performance curtailed by external factors. On the other hand, unexpected requirements drove up the need for trucks.

Limitations on Supply of Trucks. Earlier in the chapter, we commented on how the RFF process tended to screen out such logistics assets as cargo trucks. Widespread interviews indicate that units such as truck companies were often treated as individual elements in the deployment planning process rather than an integral part of a broader capability. Thus, when the need for a truck unit was questioned, it was difficult to justify in terms of effects on overall combat capabilities.

Mobilization timing also affected the supply of trucks. Most combat service support units (CSS) are in the reserve components and require about 90 to 120 days to mobilize and deploy.³⁴ So to have units ready by the start of combat operations would have required mobilization before the December 2002 holiday season. As a result, in some cases, it was decided to delay CSS mobilizations. The combined result was that cargo truck units shifted to later in the deployment flow through a series of deploying planning conferences and in the RFF process.

We were not able to locate clear documentation of the total cargo truck requirement across echelons. Various organizations developed their own estimates, but we have been unable to document the total theater requirement for the dry cargo distribution system *over time*. The 377th Theater Support Command (TSC) did report a requirement of 930 medium trucks when operations commenced with just 515 on hand, including host nation support.³⁵ The 3rd COSCOM reported having 20 percent of its requirement at the start of combat operations.³⁶

The decision to provide fewer trucks than requested may have been influenced by the lack of adequate theater distribution planning tools. No integrating tool enabled comprehensive, consistent planning across echelons. Rather, each echelon used its own tools. For example, the theater support command used spreadsheets and computer-aided design software. Although such methods are effective for deliberate planning, they are less effective for dynamic evaluation as operational and deployment plans change. Dynamic evaluation could be important for providing decisionmakers with assessments of how such changes affect sustainability.

Yet another limitation on truck supply was that contracted truck assets could not be used to the levels anticipated during combat operations. The TSC reported that in

³⁴ Based upon actual times for OIF.

³⁵ Interview with Colonel Dan Lee, support operations officer, 377th Theater Support Command, 2004.

³⁶ Interview with Fletcher.

addition to organic truck shortfalls, contracted truck support fell short of expectations. This appears to have happened in part because of low operational readiness rates for contract trucks and in part because of security issues, with the Iraqi resistance preventing some use of planned contractor truck augmentation.

Compounding the problems listed above was the fact that the trucks that were on hand did not provide the expected capacity. Two factors reduced the effective distribution capacity. The first was road throughput. Expectations about the quality of the main supply route (MSR), which derived primarily from photographic reconnaissance, turned out to be wrong. The MSR appeared to consist of standard paved, two-lane roads. In reality, the road edges were falling apart, effectively making the route a one-lane road, and some stretches turned out to be improved dirt roads. For much of the route, usable shoulders were limited; they consisted of talcum powder-type sand. It became hard to drive through this material due to dust and the pulverization of the sand. Additionally, the unexpected resistance in As Samawah forced all traffic to use an unpaved alternative supply route to the west.³⁷ The result of these problems was much slower movement than the expected 30 kilometers per hour.³⁸

Convoy disruptions also resulted in some delays. Some convoys stopped due to enemy action, whether directly involving the convoy or simply occurring in the general vicinity. At other times, drivers stopped when they saw fires or Iraqis under guard,³⁹ and there were reports of units simply stopping to take an uncoordinated break. After long periods of continuous operations, there were also reports of drivers falling asleep and blocking traffic, with no one realizing why the convoy had stopped. Having only one driver per truck in some cases contributed to sleep problems, as well as to the slow identification of such problems.⁴⁰

A major factor that temporarily hindered distribution capacity—in fact, nearly stopping it entirely—was the *shamal* or sandstorm. It started in the afternoon of March 24 and ended about midnight on March 26, with periods during which it became close to impossible to drive. Limited to literally inching along at about two miles per hour with drivers hanging their heads out the sides of vehicles to see the road, some convoys simply stopped.⁴¹

Unexpected Increase in Demand for Trucks. Aside from the question of whether the force had sufficient distribution assets to support the plan were two factors that changed both distribution system requirements and available assets from planning

³⁷ Interview with Wallace, 2004; 3rd Infantry Division (Mechanized); Fontenot, Degen, and Tohn.

³⁸ Interview with Baca; Lieutenant Colonel Dave Powell, "OPERATION IRAQI FREEDOM Rock Drill," briefing on DESERT STORM Truck Deployments, 1992.

³⁹ Lieutenant Colonel Katherine Cook, email discussion with the author, June 2, 2004.

⁴⁰ Interview with Fletcher.

⁴¹ Interview with Major Pacheco, 3rd COSCOM S-3 shop, September 2003.

estimates: the decision to provide troops with bottled water throughout the operation and the unanticipated need to use trucks for unit movements.

Planning assumed that units would cross the line of departure with bottled water and transition to bulk water production and five-gallon cans within five days.⁴² Subsequently, the decision was made to rely on bottled water for drinking. This significantly increased cargo distribution demand, with reports of 60 percent of dry cargo “line haul” or lift assets being devoted to bottled water—a need exacerbated by the high bottle breakage rate that occurred when cases of water were broken open or crushed, slowing handling and further increasing demand. In fact, twice as many trucks were used to move bottled water as food.⁴³

Another unplanned demand for distribution assets was the use of trucks for unit moves by the 101st Airborne Division (Air Assault) and the 82nd Airborne (ABN) Division’s 2nd BCT.⁴⁴ Unexpected resistance and continued threats from Fedayeen fighters required that An Najaf and As Samawah, both astride the supply lines, be secured by other units before the 3rd Infantry Division could continue its advance. Trucks were used to help move these units into place. Finally, deployment delays and even some planned deployment flows also required the use of trucks for force reception in Kuwait.

Theater General Support Stocks. If spare parts and other supplies could be shipped cheaply and quickly from the United States to units in combat, there might be no need for prepositioned stocks deployed forward in various theaters of operations. In fact, for small, expensive items like circuit cards that can be flown quickly to the theater of operations with a small airlift burden, forward support stocks are largely unnecessary. Large, heavy items like tank tracks, on the other hand, are extremely expensive to ship by air. It is far cheaper to ship them by sea, but since sealift may take 60 or more days to arrive at distant theaters, it is necessary to stock supplies of these items forward in the theater able to handle the sealift replenishment time. Doing so saves money, while also freeing scarce high-value and high-cost airlift for critical missions.

Two general types of items should be positioned forward to minimize the reliance on airlift for sustainment. The first type consists of items with large, smooth demands—those items that continuously get consumed and generate large volume regardless of weight and size. Food is the primary example. The other type consists of big, heavy items with a relatively high ratio of shipping cost to purchase cost, such as construction materiel, ammunition, some spare parts like tracks, and other items such as tents. From a sustainment standpoint, positioning sizable stocks of these items

⁴² Colonel James Lee, support operations officer, 377th Theater Support Command, email, July 20, 2004.

⁴³ 3rd COSCOM, Commander’s daily update briefings, 2004.

⁴⁴ Lee email, July 20, 2004. The need for additional distribution assets is discussed in general terms in many descriptions of the operation, although they do not generally acknowledge that this requirement was not planned for and was met by using assets intended for sustainment.

forward saves airlift for lower-demand, smaller items; expensive items; and emergency missions.

In OIF, the parts and other supplies stored forward for contingencies in Southwest Asia—warehoused in Qatar and aboard two ships, designated as “swing” stocks—were not well configured to support operations or reduce demand on airlift. Many of the parts in these forward stocks were never requested by combat units. And many large, heavy parts were not stocked at all, necessitating the use of airlift for resupply, at considerable cost. Additionally, small parts were bulk stored in large containers and had to be unpacked and organized before orders could be filled. Many of these relatively small items could easily have been provided from CONUS via airlift but required considerable effort to organize and manage in theater. Together, these factors made rapid initiation of effective theater supply operations difficult.

Strategic Distribution

Strategic distribution consists of two major sets of activities: preparing materiel for shipment from the United States, and moving it to the operational theater.⁴⁵ These activities are conducted by the strategic distribution platforms, consolidation and containerization points (CCPs), other distribution centers, and the air and sea ports of departure and arrival depicted in Figure 9.2. To enable rapid deployment and initiation of operations with a capable but austere theater distribution system, it is critical that the strategic distribution system, based largely in the United States, minimize the distribution workload required in theater.

In particular, it makes sense to take shipments intended for combat units and consolidate them at permanent, fixed facilities, enabling rapid delivery to SSAs without repackaging in the theater. Building loads in CONUS for a given SSA supports the seamless delivery of materiel from distribution centers to SSAs with limited delay and minimal in-theater workload. No stops are necessary to unpack, resort, and repack-age loads. Rather, they can simply be transferred from one mode of transportation to another. The better the consolidation of materiel on pallets and in containers, the better the synchronization of consolidated shipment construction with transportation schedules, and the more coordinated the transshipment flow of cargo across modes and nodes, the faster the delivery of supplies to their customers will be. Tightly scheduling and coordinating when loads are declared full, when trucks run from a warehouse to a port, when planes leave each day, when ships sail, and so on enables effective synchronization. Positioning inventory at the start point of scheduled transportation where

⁴⁵ For an overview of strategic distribution and its performance in Operation ENDURING FREEDOM, see Marc Robbins et al., *The Strategic Distribution System in Support of Operation Enduring Freedom*, Santa Monica, CA: RAND Corporation, DB-428-USTC/DLA, 2004.

loads are consolidated for overseas shipment is the final step to moving items to theater as fast as possible.⁴⁶

Strategic Distribution in OIF

Strategic transportation was able to maintain a fairly consistent, scheduled flow of transportation to the theater, albeit with some periods of perturbation, but problems with packing and consolidating materiel prevented fast strategic distribution. Generally, the system adjusted airlift capacity rapidly to changing demand through the use of commercial air charters and the rerouting of air channels. However, significant problems developed in the warehouse and load-building portions of the strategic distribution system, leading to both CONUS delays and downstream effects in theater.

The early phases of OIF illustrated the problems that ensue when loads are not packed in the United States in a way that the theater distribution system is designed to handle. The CCPs supporting OIF initially sent so-called “mixed” loads—loads containing supplies for many different units operating in Iraq—to the theater distribution hub in Kuwait (and later to a central hub in Iraq). This increased the workload in theater, where the loads had to be broken down and repacked, exceeding theater and unit-level capabilities and resulting in delays and “misdirected” shipments, which exacerbated the shortage of parts at the SSAs and units.

Figure 9.6 illustrates the effect of mixed loads. It displays average requisition wait time (RWT) in days for shipments sent by air to the theater.⁴⁷ The top series shows RWT for items sent on pallets constructed at aerial ports of embarkation (APOEs) by Air Mobility Command, and the bottom series shows RWT for items shipped on pallets built at a consolidation and containerization point (CCP). The latter has accounted for 93 percent of shipments sent by air through the course of OIF but only about 60 percent of the weight, since many of the large, heavy items are sent straight to the APOEs for shipment.⁴⁸ The first two data points for each series show performance to Kuwait in calendar years 2001 and 2002. The remaining data points show monthly times from January 2003 to June 2004. From 9 or 10 days to Kuwait before OIF, times climbed to as high as 33 days on average for shipments in CCP pallets. Materiel on APOE pallets has continually taken longer. Lacking the effective synchronization of CCP pallet flow, before OIF these deliveries took twice as long as CCP pallet shipments. Note, however, that for a period in mid-2003, RWT for the two modes of air shipments

⁴⁶ Mark Y. D. Wang, *Accelerated Logistics: Streamlining the Army's Supply Chain*, Santa Monica, CA: RAND Corporation, MR-1140-A, 2000.

⁴⁷ RWT measures the performance of the logistics system from the SSA perspective: how long it takes to fill an SSA requirement for a part.

⁴⁸ The Military Air Line of Communication (MILALOC) accounted for only 40 percent of the air shipping weight through July 2003. Since September 2003, over 70 percent of air shipments in terms of weight have gone MILALOC as DLA started building pallets at its Red River, Texas, distribution center, which provides many big, heavy items such as track.

Figure 9.6
Requisition Wait Time for Army Units in Operation IRAQI FREEDOM, Without Backorder Time

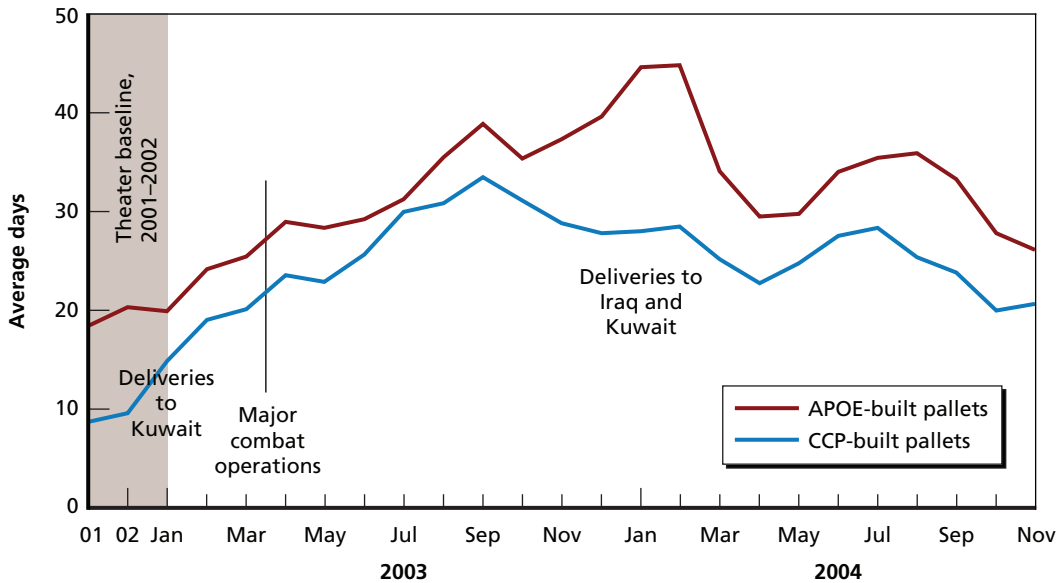

RAND MG641-9.6

converged. As we will see, this was due in large part to how CCP pallets were built. Problems with load consolidation largely eliminated the CCP-pallet advantage until they were resolved in November 2003, and the two lines begin to diverge again at that point. In March 2004, CFLCC worked out a new pallet-build policy with Air Mobility Command, leading to improved alignment of load consolidation at APOEs with the theater distribution setup and capabilities. Immediately, dramatic improvement is seen in RWT for shipments delivered via APOE-built pallets. The lower volume of materiel sent to the ports and some special requirements, such as for hazardous materiel, prevent complete replication of CCP practices at the APOE, but some degree of convergence is seen in the data as the two flows once again became much more similar, this time in the right direction.

Researchers from RAND Arroyo Center analyzed operations at the distribution centers and determined that three segments of processes there went from a sum of 3 to 3.5 days to a maximum total of 15.5 days, and monthly theater distribution time peaked at 12.5 days with a monthly best of 7.7 days since shipments started going into Iraq. The analysis indicated that the increased time resulted from problems with the building of loads at the CCP and at APOEs.

Multipacks and Pallets. The process of packing supplies for shipment to deployed units has two components. One is the boxes containing supplies. The orders for a given SSA are packed in large cardboard boxes called “multipacks.” Typically the multipacks

contain dozens if not over a hundred individual orders. The second component is when several multipacks are consolidated on pallets, generally wrapped in shrinkwrap. Problems occur whenever orders for more than one SSA are put in one multipack or multipacks for more than one SSA are loaded on a single pallet. When pallet loads only have materiel for one SSA, they can go from the CCP in CONUS to the SSA without stopping for resorting and repackaging. However, early on in OIF, many multipacks had materiel for multiple SSAs. Some multipacks were used simply to consolidate small loose shipments for transportation; such multipacks were sent to the theater distribution center. This occurred when DLA did not know which SSA the materiel should be sent to. Multiple-customer multipacks affected performance well into the summer of 2003, while CCP pallets remained mixed through November 2003 and APOE pallets for a longer period.⁴⁹ Figure 9.7 illustrates the ideal configurations for multipacks and

Figure 9.7
Box (Multipack) and Pallet Configurations

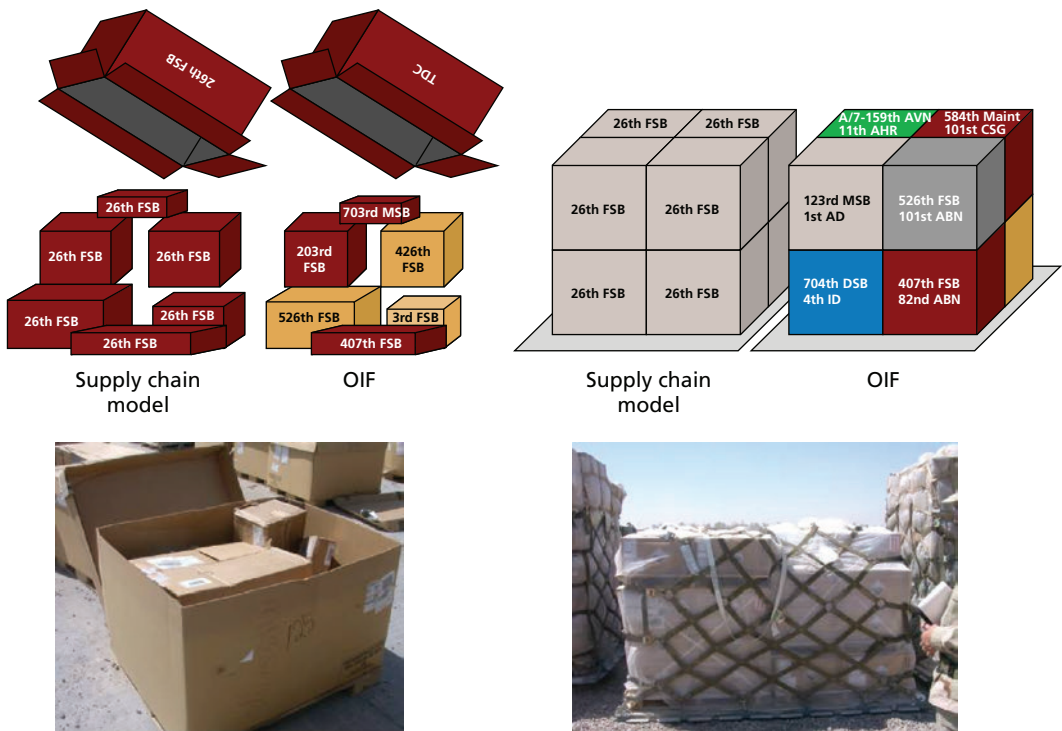

RAND MG641-9.7

⁴⁹ Some APOE pallets continue to be mixed, but this represents a small percentage of the pallets sent to theater beyond March 2004.

pallets and examples of what “bad” configurations looked like in OIF. Photographs of multipacks and pallets are provided as well.

Mixed Multipacks. To build multipacks, DLA’s distribution centers employ what is termed sortation logic. Each designated SSA gets a separate location at the bottom of a chute where the multipacks are filled, and packages for delivery to the SSA are automatically sent there. So the first thing DLA must know is the list of SSAs to receive shipments. It also must have a way of knowing which SSA multipack box a shipment goes in when the order comes directly from a supported unit rather than an SSA.

Before OIF, all of the SSAs were set up to have chutes and receive “pure” or single SSA multipacks. Each SSA is identified by a Department of Defense Activity Address Code (DODAAC), essentially an automated address, which every unit also has. So in effect, DLA has chutes for specified SSA DODAACs and knows how to map unit DODAACs to SSA DODAACs.

Problems in OIF began with the Army’s decision to use so-called “sterile DODAACs.” To separate OIF expenditures from all others, every unit and SSA received a new DODAAC for OIF. This decision required DLA to reconfigure its packing and consolidating activities to align with a new list of SSA and unit DODAACs. For the SSAs that deployed, their chutes were tied to home station DODAACs, not their new ones, and their supported units no longer mapped to them. When sterile DODAACs were first “turned on,” DLA did not recognize the new SSA DODAACs as multipack or “ship-to” locations, did not know which new DODAACs were SSAs, and did not know which supported unit DODAACs mapped to the new SSA DODAACs.

The upshot was that when units first deployed, their SSAs often did not get their own multipacks for the first several weeks. Rather, their materiel ended up in multipacks addressed to the theater distribution center or even in multipacks for other SSAs. The latter case was particularly problematic, because the distribution center would have no way to know that the multipack was mixed and would thus send it on to the SSA it was addressed to. Thus, the shipments inside the box for other SSAs would be misshipped, and redistribution of such misshipments to the correct SSA was haphazard.

Mixed Pallets. The DODAAC problem spilled over into the loading of pallets because that information is critical for pure SSA pallets as well, but the causes of mixed SSA pallets transcend problems with information flow and sortation logic. In the 1990s, the Army and DLA had worked hard to institute service directly to every major SSA. In CONUS, this meant the initiation of scheduled trucks, with the trucks loaded in SSA order so they could do a “milk run” (a multiple-stop delivery route like those once typified by milk deliveries) around each installation, stopping at each SSA and quickly dropping off its materiel. Outside CONUS, this meant pure SSA pallets that could be delivered through a synchronized theater distribution network taking the pallets from the aerial port of debarkation (APOD) to SSA without delays for repackaging. Thus, before OIF, most SSAs in U.S. Army Europe (USAREUR) and Eighth U.S. Army in Korea received pure SSA pallets. While this had been a standard practice

and reflected *Army* doctrine, it is clear from OIF that this practice had not yet become embedded in *joint* policy.

As volume started ramping up in early 2003 and more than a couple of SSAs deployed, it soon became apparent that shipments were not consolidated by SSA. In part this was due to the lack of good SSA DODAAC flow from ARCENT/CFLCC to DLA. But it was also due to the lack of an agreed-on plan to do so. Materiel was arriving on pallets mixed across divisions and other major units. As with mixed multipacks, this was not always clear, and so the full mixed pallet might be sent to a single SSA, leading to misdirected shipments.

The miscommunication and misunderstandings continued through November 2003, when sufficient information and proof had been provided to all parties to clarify what was really happening and what effects it was having on theater distribution. At that point, CFLCC reemphasized the need for pure pallets, and DLA implemented a SSA-pure policy at the CCP.

Aerial ports were a different matter. Some materiel, by rule, gets sent to APOEs for shipping consolidation rather than going through the CCP. Materiel that bypasses the CCP includes hazardous, oversized, sensitive, and other specially designated items. However, aerial ports were never set up as distribution center/CCP-type operations. They just built pallets to support efficient transportation, consolidating pallets by APOD, regardless of unit or service. This is how APOE support to OIF started.

When CFLCC worked with DLA to get CCP SSA-pure pallets, resulting in the geographic region pallets instead, it also got a commitment from port officials in Charleston to build service-pure pallets. In the end, this does not seem to have helped much, as Army pallets often had materiel for units in completely different parts of Iraq.

A problem arose in that these pallets did not appear markedly different from CCP pallets, and not everyone in CFLCC knew the precise CCP and APOE practices. The result was that for an extended period, many pallets were sent straight to a single division, even though they contained materiel for multiple divisions or nondivisional units. Starting in April 2004, the APOEs began building SSA-pure pallets for the highest-volume SSAs, and they consolidated other Army materiel on geographic region pallets.

Additionally, as demand from the mounting counterinsurgency grew well beyond expectations, CONUS distribution center capacity was not ramped up quickly enough, leading to substantial delays within CONUS as warehouse backlogs developed.

National Supply Management

The mission of national supply, shown on the far left side of Figure 9.2, is to have an item available at the right place for shipment upon demand. That is, the system must ensure that enough supplies are ordered and positioned to support readiness efficiently. In peacetime, the system should purchase enough inventory to meet wartime demands until production can increase deliveries as needed to fill the distribution pipelines. Good inventory support requires effectively structured and funded war reserves and

agile “surge” processes. These processes include estimating the requirements to support a contingency, gaining approval to order supplies in advance of operations, and the actual production of supplies by Army arsenals and maintenance depots and private-sector firms in the Army’s industrial base.

National Supply Management in OIF

As operations continued at a heavy pace into the summer of 2003 and beyond, national stock availability became an increasing problem. War reserve requirements did not include many critical items and were poorly resourced, limiting their value in meeting the Army’s requirement for spare parts until a production surge could kick in. The inadequacy of war reserve requirements resulted from planning guidance that limited war reserve to five months of combat operations, which is shorter than the lead times for many parts, and problems with the accuracy of the processes for determining requirements. Despite a lack of robust war reserves, a production surge for Army-managed spare parts, which include the major components found on most weapon systems, was not funded until the second half of 2003, several months into OIF. Combined with the limited war reserve stocks, this meant that the surge in production and procurement for OIF came too late to prevent the high, sustained demand rate from depleting inventories throughout the supply chain. This led to a high level of backorders and, ultimately, to a lower level of equipment readiness.

Command and Control

Depicted at the top of Figure 9.2 is the final crucial element of the supply chain: joint command and control (C2). Effective joint C2 will ensure that the various organizations spanning the supply chain remain integrated and focused on the common objective of providing the best overall support possible. C2 serves four key functions.

First, C2 must integrate planning so that each organization in the supply chain knows precisely what its suppliers are doing and what its customers expect. The detailed policies and processes of every organization must be designed and exercised to ensure tight alignment with the overall vision and with its customers and suppliers. If one organization in the chain plans using incorrect assumptions about the practices of another, serious problems can develop.

Second, once a planned process is being executed, monitoring and control are crucial to ensure that it is working well. Problems need to be identified and corrected as soon as possible. This requires good data transformed into effective information for people who can fix a problem quickly or change the appropriate portion of the supply chain.

Third, the same kind of information also enables the managers of the supply chain to use assets efficiently.

Fourth, this information is crucial to good situational awareness. The better the situational awareness, the more effective the planning and decisionmaking processes

conducted by commanders and their staffs will be. They can more accurately judge risk and when to continue with a plan or pursue a different course of action. In this vein, logistics situational awareness can affect operational and even strategic decisionmaking in addition to enabling more effective support within a broader operational plan.

Command and Control in OIF

We have already referred to some of the command and control issues that surfaced during OIF. For example, CONUS load-building practices were not aligned with theater distribution capabilities, nor were theater inventory requirements well aligned with the ideal use of different strategic transportation modes. Also, incorrect unit address codes were sometimes not corrected for several weeks, disrupting the flow of spare parts to units.

In some cases, the lack of situational awareness engendered by command and control issues increased the perceived level of risk.⁵⁰ Because unit commanders limited in-transit visibility at their level, supplies just seemed to show up. Such seeming uncertainty dramatically increased the perceived level of risk. The fact was that while stocks were lower than planned, supplies were continuously being pushed forward. The problem was that units had no visibility into what was en route.

Concluding Observations on Sustainment in OIF

In spite of some problems, the DBL approach worked. Lessons learned during OIF, applied properly, should lead to a more efficient and effective system in the future. That said, fortune favored coalition forces in many ways. The Iraqi army, handicapped by inept and paranoid leadership, did not fight nearly as well as its capabilities suggested it could, even in its degraded state. Better leadership could have led to a much more spirited and effective defense, and logistical problems could have assumed greater import. Furthermore, if the Fedayeen had been less fanatical and more willing to focus their effort on disrupting coalition LOCs by attacking logistical vehicles rather than launching frontal attacks on armored vehicles, they might have had a more profound effect. They certainly could have complicated sustainment operations far more than they did.

⁵⁰ For a fuller discussion of command and control problems, to include situational awareness, see Chapter Seven.

Conclusions and Recommendations

Events leading to the invasion of Iraq, the behavior of the Iraqi regime, and the course of Operation IRAQI FREEDOM and its immediate aftermath suggest that the U.S. Army can improve its ability to participate in joint coalition operations in several ways. Such improvements—what they would entail, how the Army could address them—are suggested in this chapter. The recommendations listed here are based on conclusions and implications drawn from events and analyses presented in the preceding chapters.

However, we must be cautious in drawing any lessons from this campaign. As discussed in Chapter Six, the enemy the coalition faced in Iraq was generally demoralized, unwilling to fight for Saddam Hussein, and inept as a result of poor training, inferior equipment, and the lack of competent leadership. This was an enemy that “didn’t show up.” The fiercest fighters were the Fedayeen Saddam. As fierce as they were, however, they were not trained soldiers; loyal in the extreme to Saddam, they were willing to confront heavy armor with small arms. Moreover, as noted in Chapter Four, there were several battles in which some enemy forces offered stiff resistance.

Planning

Throughout the planning process, the concerns of the President and the Secretary of Defense centered upon the size of the U.S. force, the time required to deploy it, its ability to prevail quickly, and the negative effects of noncombatant casualties. Although post-conflict peace and stability operations were discussed, warfighting dominated most of the meetings leading up to the invasion of Iraq. Broad, overly optimistic assumptions were made about the viability of a new Iraqi government following major combat operations, how the population would greet invading coalition forces, and the overall security environment likely to be confronting these forces. Moreover, these assumptions were rarely questioned or revisited.

Invert campaign planning. *When a desired endstate (such as regime change) has been established, a robust interagency process should take the lead in planning to achieve that end. The planning process should begin with the endstate—i.e., planning should be*

“inverted”—so that all political and military, diplomatic and economic, intelligence and information operations directly support the end to be achieved. The joint military community may have to cede its traditional lead in early planning to an interagency process.

Recent conflicts (since the end of the Cold War) tend to resemble the Iraq experience more than they do conventional conflicts of the first half of the 20th century. In the future, the likelihood of more such Iraq-like conflicts, which involve U.S. and allied forces defeating an outmatched opponent's forces quickly and then spending months or years trying to win the peace, appears to be high—or at least not an isolated incident. This likelihood argues for a different kind of planning process than the one followed in Iraq. The new process should be less linear or sequential; it should feature elements of simultaneity and what might be called an “inverted” planning process. In such a process, the military and civilian contributions required to secure, reconstruct, and govern the peace (as opposed to the forces required to win the war) should be the primary focus of the plan. This means that planning should start from the desired end-state and work backward; hence, “inverted” planning also means that the military may need to cede the lead in planning to a robust interagency process.

This is not a new idea. Presidential Decision Directive 56 (PDD-56) defined a planning model centered on the National Security Council that called for a Deputies Committee to establish an interagency working group to bring together representatives of all agencies needed to participate in the planning process. Furthermore, a 1998 RAND publication, *Civilians and Soldiers: Achieving Better Coordination*, argued that (1) the President should issue political-military plans binding on all officers and officials of the executive branch; (2) the United States should plan in advance for those contingencies likely to prompt intervention (such as Iraq); and (3) combatant commanders should be brought into the interagency process in a more systematic way, so as to ensure that post-hostilities planning becomes routine. These recommendations are still valid today.¹

Revamp the deliberate planning process. *The joint military community should revisit its deliberate planning processes to make them more responsive when dealing with operations in remote parts of the globe.*

OIF planners, under pressure from the White House and the Secretary of Defense as well as for reasons both tactical and practical, rejected the lengthy buildup over six months of personnel, equipment, and other materiel that characterized DESERT STORM. Tactically, they believed that Saddam might reasonably expect coalition forces to repeat what they had done in DESERT STORM and shape his plans accordingly. Practically, there was far less need to follow a deliberate buildup model. The

¹ Bruce Pirnie, *Civilians and Soldiers: Achieving Better Coordination*, Santa Monica, CA: RAND Corporation, MR-1026-SRF, 1998.

United States had already established a large force presence in the region, and it had been able to move additional forces into the region quietly. For example, by December 2002, there were some 60,000 U.S. troops and 400 aircraft based in the region, including combat forces. Furthermore, the Iraqi army was a shadow of its former self, and its former self had been unable to mount a serious challenge against coalition forces in DESERT STORM. Finally, the United States had improved its ability to deploy forces.

The Time-Phased Force and Deployment Data (TPFDD) process was rejected by Secretary Rumsfeld in Afghanistan and again in Iraq. In its place, a request for forces (RFF) process proved to be more agile and flexible for Rumsfeld's purposes than traditional deployment procedures, but it had disadvantages as well. One was that the RFF process required approval of each force package, which opened it to micromanagement at multiple levels. Final approval of each RFF was at the level of the Secretary or Deputy Secretary of Defense. An RFF could be approved, modified, or denied. Secretary of Defense Rumsfeld claimed that use of the RFF process was necessary to help the President align the diplomatic with the military roads to war. However, the RFF system did not mesh well with the plans and expectations of units anticipating a different set of deployment procedures (i.e., the TPFDDs). This disconnect was particularly true of the reserve components, whose mobilization procedures involved a series of pre-planned steps and an expected timeline. As a result of the time consumed, as well as the procedural complexity associated with bringing a reservist onto active duty, many RC members did not show up at the right time or in the correct order, and some members who were called up were not used. A sometimes more serious problem occurred when expected support forces associated with a requested force did not materialize. The TPFDD process recognizes the requirement for these support forces and plans for their deployment in time to ensure that the requested force can be effective.

What is needed is a planning process that will respond quickly to emerging conflicts in those parts of the world where no "off-the-shelf" plan exists or where the off-the-shelf plan is not sufficiently responsive. The TPFDD process might have been too slow and clumsy, but the more agile RFF process proved to be inadequate as well.

Planning for Post-Conflict

Recent operations have made it abundantly clear that wars do not end when the major conflict does. Some sort of follow-on operations will be required until the strategic objectives, not just the military ones, have been accomplished. The hard reality is that the Army will inherit at least some, if not all, of the responsibility for carrying out those operations, particularly the immediate establishment of security and order. While the nature and scope of those operations will vary from conflict to conflict, plans need to prepare for them under a variety of possible circumstances.

Plan for post-conflict operations. *The Army needs to incorporate post-conflict operations into its Title 10 responsibilities to organize, train, and equip forces to carry out the missions given to the combatant commanders.*

The Army needs to be able to dominate enemy forces during major combat operations. But it also needs to make itself the full-spectrum force that its doctrine envisages. This task involves important organizational, equipment, and training issues that cannot be addressed by assuming that well-trained combat units can carry out any “lesser” tasks. Skills required for crowd control, use of nonlethal weapons, restoring civil order, counterinsurgency, and reconstruction support do not naturally flow from training for major combat operations. Soldiers can be trained for post-conflict tasks, but it requires targeted training and specialized equipment.

The military planning process needs to broaden its focus. *The military planning process should begin with the desired endstate of the entire conflict, not just the fighting.*

Defeating the armed forces of the target country is a crucial step but not the only step. Strategic endstates often involve fundamental political changes that are either secured or lost in the aftermath of major combat. History shows that the Army will be engaged in helping secure those strategic objectives, so it needs to plan for its involvement in postcombat operations as thoroughly as it plans for combat operations.

Land Forces

Heavy forces were the dominant type of land force. The combination of main battle tanks and armored personnel carriers, supported by highly responsive artillery fires and close air support, was overwhelmingly effective against Iraqi defenders.

Tanks usually led the advance on any terrain that would support their weight. They achieved shock effects, delivered highly effective fires, and proved almost impervious to Iraqi weapons. They also proved to be effective in urban combat. The protection and firepower of the tank compensated for generally poor situational awareness at lower tactical levels. Infantry fighting vehicles usually followed the tanks and engaged targets that the tanks flushed from cover. The 25mm chain gun on the M2 Bradley was effective against a wide range of targets. While not as impervious as the Abrams, the Bradley enjoyed adequate protection against most of the threats encountered in Iraq. The Marine Corps suffered from the lack of a vehicle in the Bradley class. Their Amphibious Assault Vehicles (AAVs) were designed for amphibious assault, not protracted land combat. Yet despite the limitations of the AAV-7, that vehicle provided valuable armored mobility and firepower to the Marine Corps infantry battalions that fought in Iraq. The British Army’s experience with its Challenger 2 main battle tanks and Warrior Infantry Fighting Vehicles was very similar to that of the U.S. Army.

Medium-weight forces also played important roles during the campaign. Medium-weight vehicles included the British Army's Scimitar and the Marine Corps' Light Armored Vehicles (LAVs). They were predominately used for reconnaissance and screening in open and mixed terrain. However, they lacked sufficient protection for assaults in urban terrain. More recent deployments of the Stryker Brigade Combat Teams suggested that they may be able to play a role in urban counterinsurgency operations. While not a fighting vehicle, the Stryker does offer some ballistic protection and, equipped with slat armor, has shown itself to be reasonably robust against enemy attacks. It also provides valuable command and control capabilities, and it operates relatively quietly, which can be an advantage in urban fighting.

The light forces operating in southern Iraq (the U.S. Army's 101st Airborne Division and elements of the 82nd Airborne, plus the British 3rd Commando and 16th Air Assault Brigade) generally secured urban areas bypassed by leading armored units. However, U.S. and British light forces benefited from having armor attached to them. Both U.S. Army and British Army after action reports state that the light forces often needed armor support for urban operations.

Retain mixed forces. *For the foreseeable future, the Army should retain a full range of forces—heavy, medium, and light—since one type of force alone cannot be expected to accomplish all the Army's likely missions.*

Heavy forces are required for decisive combat in terrain ranging from open desert to urban areas. Particularly against irregular forces, such as those encountered in Iraq, the Army will seldom know where enemy forces are located until close combat begins. The enemy will often fire first, and Army forces must have enough protection to survive first-round hits and keep fighting.

Medium-weight forces require less maintenance and resupply than heavy forces. For example, the Marine Corps noted that by the first week of April, their wheeled LAVs were in generally better condition than their tracked vehicles. They also excel in reconnaissance and screening missions, but they lack the protection and firepower required for assaults against prepared positions.

Light forces, including airborne, air assault, and light infantry forces, provide the dismounted strength required to defeat enemy forces in complex terrain and to control entire populations. During postwar interviews with British Army representatives, several of them opined that the lessons of the war highlight the need to retain a heavy-medium-light force mix well into the future. The U.S. Army had already decided to move in this direction.

Close Air Support

Close air support (CAS) with fixed-wing aircraft was usually responsive, typically on the order of 10–15 minutes when aircraft were available in “CAS stacks” (orbit points where fighters were held until a ground unit needed them or they were low on fuel). Few incidents of fratricide occurred as a result of close air support, although some did take place (e.g., the marines in An Nasiriyah on March 23). CAS proved effective in a wide range of circumstances, including battles fought in bad weather and in urban areas. Indeed, air-delivered munitions were advantageous for urban combat because they were both precise and devastating.

As good as close air support was in OIF, it was not responsive enough for the counter-fire mission. Both the Army and the Marine Corps placed great emphasis on quickly suppressing Iraqi artillery and mortar fire. As long as a Firefinder radar was available to locate the enemy’s firing location, U.S. artillery could fire back at that enemy position within two to three minutes. Fighters took much longer, especially if enemy weapons were not observed by U.S. personnel on the ground. In that case, Type III CAS procedures had to be used. Deconfliction times of 30 minutes or longer were typical, far too long to engage enemy indirect fire systems.²

Standardize terminal attack controllers. *All services should cooperate in a joint program to assure that terminal attack controllers (TACs) and forward air controllers (FACs) meet a common standard of proficiency, use the same terminology, and share comparable equipment.*

The Joint Terminal Attack Controller (JTAC) program, which was under the aegis of the former Joint Forces Command, would lead in this direction. The services should assure that controllers are normally available at company level in maneuver forces. Eventually, the services should consider training personnel to be universal observers, equally proficient in controlling indirect fire weapons, attack helicopters, and fixed-wing attack aircraft.

Integrate fixed- and rotary-wing procedures. *In as many ways as they can, the Army, the Marine Corps, and the Air Force should improve the integration of helicopters with fixed-wing aircraft.*

There should be procedures to share reconnaissance across both communities. Joint air attack should be regularly practiced. Furthermore, in the absence of a sepa-

² Three variations of close air support, employed in Iraq, are defined in Joint Publication 3-09.3, *Joint Tactics, Techniques, and Procedures for Coordinating Close Air Support (CAS)*, September 2003. Type I CAS is traditional CAS with close control by the terminal controller. Type II CAS is less restrictive in that it assumes the terminal controller may or may not see the target and the pilot has the ability to attack the target without seeing it. Type III is the least restrictive: Aircraft are given clearance to engage targets that are not in direct contact with friendly forces. Aircrews are left to find targets on their own while being monitored by the terminal controller.

rate airborne forward air controller, terminal attack controllers should routinely ride in Kiowa Warriors, or else one member of the crew should be qualified as an air controller.³

Deconflict air and artillery. *The Army should champion or at least support improving procedures to deconflict air and artillery attacks on unobserved enemy weapons locations.*

Field artillery appears to be much better suited for the time-sensitive counter-fire mission than aircraft. Nevertheless, improved procedures to deconflict attacks could improve the responsiveness of aircraft in the counter-fire role.

Rotary-Wing Operations

During OIF, U.S. Army, U.S. Marine Corps, and British units planned numerous air assaults into Iraqi-controlled territory that lay forward of the leading edge of advancing ground forces, but they decided not to conduct them. One cause was poor weather conditions, for example, the three-day sandstorm that grounded helicopters. Another was the difficulty of establishing forward arming and refueling points, which were required for the mission. In some instances, a rapidly changing ground situation produced a decision not to execute.

Commanders weighed the risks against the expected benefit from a successful helicopter assault and decided that the risks were too great. Because the main threat to low-altitude aircraft in OIF consisted of small arms, machine guns, RPGs, anti-aircraft guns, and shoulder-fired missiles that did not emit electronic signatures, it was very difficult to locate such easily concealed systems before the enemy had a chance to fire on U.S. or British helicopters.

In the final analysis, the success of ground forces was probably the single strongest argument against air assault. Why take the risks associated with air assault, even manageable risks, if the ground forces could seize the same objective at little risk to themselves? It is noteworthy that U.S. Army, U.S. Marine Corps, and British Army leaders all independently reached the same conclusion about air assault operations during OIF—that the risks almost always outweighed the benefits.

The V Corps initially tried to employ its 11th Attack Helicopter Regiment in a large, deep attack against Iraqi forces in the vicinity of the Karbala Gap. The 11th suffered considerable damage without accomplishing the mission. This attack probably does not constitute a fair test of deep attack doctrine because so much went wrong: lack of any effective air defense suppression, very intense opposition, poorly chosen routes, and inadequate intelligence. Following the attack, the V Corps attempted only one more deep strike (by the 101st several nights later) and then put an end to any further

³ This is not practical for the Apache in that it would limit the aircraft's use of its weapon system, since the air controller would have to occupy the weapon system operator's seat.

deep attack missions. From that point on, both corps and divisional Apaches focused on close support of maneuvering ground elements and armed reconnaissance.

Reemphasize close combat. *As a matter of doctrine, the Army should declare “close combat attack” to be the primary mission for attack helicopters, while retaining deep attack as a secondary mission.*

The meager results obtained through deep attacks by helicopters during the Iraq campaign do not rule out deep attack as a viable mission, but they do suggest that it is less important than attacking in close combat, where attack helicopters can excel. At the same time, the Army should emphasize criteria for deep attacks that include consideration of the risks involved and other means to accomplish that mission.

Adopt helicopter best practices. *The Army should examine how the 101st Airborne Division, as well as the Marine Corps, employs helicopters—with a view to making their best practices universal.*

The Army’s 101st Airborne Division (Air Assault), for example, exploited its helicopter mobility to maneuver its ground elements to the rear of the leading elements of the 3rd Infantry Division (Mechanized). As the supply lines from Kuwait to the forward units became longer, the use of helicopters to support and defend the lines increased. In some cases C-130s also brought supplies to the forward elements, landing near them on airstrips seized from the Iraqis.

Revisit vertical envelopment. *In the process of developing concepts for future operations, the Army should reconsider the amount of emphasis placed on vertical envelopment by rotary wing aircraft.*

Until recently future Army concepts emphasized vertical envelopment operations by medium-weight units, whether armed with the current Stryker wheeled vehicles or with the Future Combat System. With the cancellation of the FCS program, the Army is rethinking its future operations concepts. However, experience in Iraq suggests that air assault into enemy-controlled territory is likely to be the exception, not the norm. The Army aviation community should also look closely at the Marine Corps’ use of helicopters, which takes advantage of their reconnaissance and “close support” capabilities.

Fire Support Control Measures

OIF displayed a high degree of air-land coordination. The killbox system functioned efficiently and helped concentrate airpower where it was most needed. The system of “stacks” and “push CAS” helped make close air support timely and continuous. In addition, relatively few incidents of friendly fire occurred. The worst such incident

(An Nasiriyah on March 23) occurred primarily because the ground forces lost track of their own locations and pilots apparently failed to recognize Marine Corps AAVs.

Despite overall success, air-land coordination was marred by rigidities that hampered the employment of air power. According to doctrine, the supported maneuver force commander was supposed to set a fire support coordination line (FSCL) along a significant terrain feature forward of the line of that commander's own troops. Such a linear control measure made sense when combat was linear, but it makes little sense on a battlefield that is nonlinear. During OIF, the "front" simply consisted of the lead elements of friendly forces advancing along several axes; there were large pockets of resistance behind these advancing units.

Short of the FSCL, the V Corps considered all killboxes closed until opened by the Air Support Operations Center that supported V Corps. Unfortunately, this center could not manage such a large area expeditiously, in part because it lacked the requisite radio communications. As a result, V Corps did not employ air power optimally. Moreover, there were no procedures to adjust the FSCL flexibly to correspond with a rapidly changing situation on the ground. The 1st Marine Expeditionary Force thought that a deep FSCL was counterproductive and therefore set its own "battlefield coordination line" at shallow depth and adjusted it flexibly.

Change to killboxes. *The services should consider changing joint doctrine, possibly replacing the FSCL with a system of killboxes.*

Nonlinear combat requires nonlinear control measures. During combat, a land component commander must be able to open and close killboxes quickly in response to a changing situation. To assure that air power is applied optimally in support of maneuver, killboxes should normally be open beyond the range of indirect fire weapons. In addition, the Air Force needs to assure that all Air Support Operations Centers have communications adequate to control aircraft over battlespaces hundreds of kilometers deep during periods of rapid maneuver.

Integration of SOF with Conventional Forces

During OIF, a special operations task force controlled the 173rd Airborne Brigade, a large conventional force. While operations in northern Iraq were successful, integration of SOF with conventional forces posed difficulties.

SOCENT was heavily involved in operations throughout the CENTCOM area of responsibility. In addition to operations in Iraq, ongoing special operations in Afghanistan and the Horn of Africa preoccupied the SOCENT staff and kept it from devoting enough attention to the 173rd Airborne Brigade.

Leaders in conventional and SOF units have limited knowledge of each other's organizations, capabilities, and logistics needs. USAREUR, SETAF, and the 173rd

Airborne Brigade, which were schooled in conventional warfare, wanted armor support for the brigade because of its exposed position in northern Iraq. In strong contrast, leaders in the JSOTF-N, who were schooled in special operations, saw armor as an unnecessary encumbrance.

SOF typically operates with very small, agile task forces. Accustomed to this mode of operation, some officers in JSOTF-N wanted to employ the 173rd Airborne Brigade in company-sized elements. Conventional forces normally operate in larger formations to generate more combat power. Thinking in these terms, officers in the 173rd Airborne Brigade strenuously resisted any suggestion that the brigade should be employed in small increments.

SOF and conventional units have different command and control systems. The SOF elements in northern Iraq had very good satellite communications systems that allowed their small, dispersed elements to remain in contact with JSOTF-N. However, they lacked the data links that are available to a conventional unit.

Cross train special operations and conventional force leaders. *Leadership training related to the employment of both SOF and conventional forces should be conducted at the Army's Command and General Staff College, the Army War College, and the pre-command courses for both battalion and brigade commanders.*

Effective integration of special operations with conventional forces will require both to change their training, doctrine, organization, and culture. The cultural differences in the way each operates could make this a rather daunting task. However, the recent emphasis on using special operations forces in a leading role is bound to lead to more instances of the need for them to collaborate with conventional forces.

Controlling the Force

Command and control arrangements in modern warfare are extremely complex and often ad hoc. In addition to the legal requirements of command, there are several categories of control to contend with, such as "operational control," "tactical control," "administrative control," and "coordination." What a commander can and cannot do when granted one or more of these authorities is often misunderstood. Furthermore, commanders are often unaware which of these authorities he or she has been granted. As much as we would all like command and control to be simplified, the exigencies of modern warfare are such that it will not happen soon. Nevertheless, the following recommendations could help improve command and control.

Improve echelonment. *The Army should support joint efforts to re-examine the organizational and operational structure of combatant commands.*

The focus should be on eliminating excessive layering of command elements and, thereby, streamlining operations. In OIF, General Franks did not establish a combined joint task force (CJTF) to command and control his forces; rather, he commanded and controlled them through CENTCOM headquarters in Doha, Qatar. The CFLCC in Doha, therefore, acted as commander of the ground forces, with V Corps and I MEF as subordinate commands. Arguably, this created excessive layering of commands. With so few divisions to command—the 3rd and 4th Infantry Divisions by V Corps and the 1st Marine and 1st UK by I MEF—a case can be made that either CFLCC or the corps/MEF headquarters might have been eliminated.

Reexamine spans of control. *The Army should initiate a study to examine the functions each commander is required to manage personally.*

The purpose of such a study would be either to reduce the number of those functions or to make them more manageable, thus creating more time for the commander to spend prosecuting a campaign.

Upgrade liaison officers. *The Army should institutionalize the placement of liaison officers with coalition and other service units.*

Liaison officers selected to fill these roles should be of the highest quality and competence, and they should receive specialized training to prepare them for these positions.

Situational Awareness

Situational awareness is perhaps the most important but least well understood aspect of modern warfare. It is generally taken to mean the degree of knowledge and understanding a commander has of the battlespace, to include the disposition of both friendly and enemy forces. However, in measuring enemy situational awareness, the amount of sensor coverage is often used as the metric for comparing both sides. Clearly, much needs to be added to sensor reports before they become what commanders call “actionable intelligence.” Although the various forces and echelons participating in OIF received decidedly different intelligence products, important lessons can be drawn from their successes and failures in getting what they needed. Situational awareness recommendations, based on OIF experiences, comprise a mixture of suggested procedural, technological, and software improvements.

Integrate collection management. *Procedures should be developed to integrate the hundreds of collection assets operating in the modern battlespace. The Army should ensure that its emerging UAV suite is also integrated.*

A consolidated mission tasking system should be established to manage theater-wide collection assets; the evidence from all detections should be consistently combined; and the resulting products should be quickly disseminated to affected units.

Incorporate armed reconnaissance information. *The Army should emphasize the use of both rotary-wing and fixed-wing aircraft in an integrated armed reconnaissance role at the tactical level.*

In developing new operational concepts and in designing new equipment, Army developers should work with Air Force Link-16 developers to ensure that maneuver forces can directly access increasingly powerful air sensors operating above them.

Multiply organic UAVs. *The Army should equip tactical commanders with organic UAVs.*

In OIF, the most useful, actionable intelligence at the tactical level was derived from organic assets. The centralized intelligence production and dissemination system devised for the operation proved to be inadequate. Indeed it is likely that, for the near term, this will continue to be the case. Consequently, it is important that the Army provide its tactical units with the organic means to acquire intelligence effectively, which means independently of a centrally controlled intelligence system for some time to come.

The UAV is just such an independent tool. However, the Army must be careful when deciding which units receive tactical UAVs and which tactical UAVs are issued. Proliferation without considered analysis can prove even more detrimental than the absence of UAVs. Issues of airspace management, bandwidth, and disconfirming evidence need to be considered.

Furnish intelligence on the move. *The Army should develop means to communicate with commanders while on the move.*

This might include investing in wideband satellite communications systems for select S-2s at brigade and echelons below to ensure that they can receive digital and voice intelligence feeds from higher headquarters and can monitor the S-3 command net. It might also include airborne relay facilities for line-of-sight communications systems that are currently in the Army's inventory.

The present arrangement of gaining intelligence during limited windows of opportunity, while standing still and exposed on the battlefield, will not meet the speed and dispersal requirements of the future force.

Expand access to SATCOM-based Blue Force Tracker. *The Army should accelerate the installation of BFT at selected commands within the Army.*

The success of Blue Force Tracker in Iraq should be exploited in this way. In OIF, commanders used BFT to communicate with their far-flung forces, navigate through

built-up areas, and locate their forces on the battlefield. Although not perfect, BFT was surprisingly effective in all three areas due to its ability to receive and transmit both terrestrial and non-line-of-sight signals.

The Army should also ensure that update latencies, and lack of integration with similar equipment used by other services, are remedied. This was evidently the Army's intent. Indeed, units subsequently deployed to Iraq were able to access the full functionality of the FBCB2 system, to include the enemy picture it provides.

Provide a common tactical picture. *The Army should encourage development of an integrated "common tactical picture" that displays friendly and enemy information needed by brigade commanders and echelons below—a picture requiring much less bandwidth than the common operational picture.*

Such a picture could be developed using organic surveillance (UAVs) and reconnaissance assets supplemented by assets from the Air Force, Navy, and Marine Corps. The "picture" required at tactical levels is generally more detailed and focused than the one required at higher echelons. For this reason, many tactical units considered the common operational picture produced by the ASAS to be irrelevant to their needs.

Enhance maneuver warfare training to reflect the limits of situational awareness. *The Army should script more realistic situational awareness into the warfighting scenarios used at its training centers.*

At the National Training Center and elsewhere, units being trained were not subjected to realistic estimates of what is known about the enemy forces arrayed against them. In many cases, it was assumed that the centrally managed intelligence system will provide information on the location of as much as 80 percent of the enemy force, with the remainder being provided by the corps.⁴ The experience of OIF indicates otherwise.

Develop an integrated intelligence architecture. *The services should work with the Joint Staff to develop an integrated intelligence architecture to support both major combat and stability and support operations.*

In OIF, several sensor systems were deployed, each managed independently and all focused on developing information on the location of enemy military formations. The integration of all these sensors into a comprehensive, integrated structure was lacking.

Going forward, the joint community must recognize that the transition from major combat operations to stability and support operations entails a major alteration in the nature of intelligence gathering.

⁴ Interview with Blount.

Space Operations

The space operations community's ability to support warfighters was considerably more developed in OIF than in the past. A fully developed GPS constellation supported a suite of all-weather-capable precision weapons and a myriad of battlefield applications of precise navigation and timing information. Among its many uses, GPS provided the most fundamental element of situational awareness—it told soldiers where they were—and when networked via satellite communications, it provided the foundation for a common operational picture. Space operators supplied these many capabilities and provided warfighters with analytical support from afar. Satellite communications enabled reach-back to the United States. Specially equipped teams and liaison officers were trained in the theater to understand their warfighting clients' needs. Nevertheless, despite many advances witnessed in OIF, the space community had yet to become a mature member of the joint warfighting team. Some recommendations are offered here to help move it in that direction.

Codify command and control doctrine for space operations. *The Army should work closely with U.S. Strategic Command and other component service space commands to develop and codify command and control doctrine for providing space operations support to warfighters in regional contingencies. Command and control doctrine should address informal interactions, such as information exchange in SIPRNET chat rooms, as well as formal lines of authority.*

Command and control of space operations was an issue of contention in the weeks leading up to OIF. The Combined Air Operations Center (CAOC) and Air Force Space Command insisted that theater Space Coordinating Authority (SCA) should reside with the Combined Forces Air Component Commander (CFACC), not with CENTCOM's Space and Information Operations Element (SIOE) as U.S. Space Command maintained. The issue was resolved only hours before the war's opening strike at Dora Farm, when the Combined Forces Commander issued a fragmentary order designating the CFACC as SCA.

Yet even after the dispute was resolved, command and control relationships remained vague. The SCA actively coordinated GPS and DSP support but deferred requests to help resolve issues involving space-based Blue Force Tracker, satellite communications, and reconnaissance satellites. Army Space and Missile Defense Command maintained nominal command and control of Army space assets via the Space and Missile Defense Command Operations Center (SMDCOC), but the SMDCOC did not interact with the CAOC or the SCA in CFACC. Meanwhile, Army spectral analysis teams, space support teams, and space liaison officers in theater interacted regularly with multiple command centers in SIPRNET chat rooms, forming self-organizing networks to exchange information as needed to accomplish their missions. At least twice, authorities stepped in to regulate these informal networks: Shortly

before the war, network managers restricted chat room access to manage traffic and stem their proliferation; after the war began, an Army space liaison officer supporting the CFLCC directed Army Space Support Teams (ARSST) to route all SIPRNET interactions with other command centers through the chain of command. It is unclear whether these management interventions helped or hindered mission effectiveness.

Enable/manage satellite communications. *The Army should review its satellite communications requirements at all levels, seek an increase in wideband apportionment to better support maneuver forces, and manage its bandwidth allocation to ensure that the highest-priority functions are served by protected communications. The Army should also move aggressively to better equip maneuver elements with tactical satellite (TACSAT) receivers and Global Broadcast System (GBS) receivers.*

Satellite communications are the backbone of modern, network-centric warfare. Although communications providers in OIF supplied considerably more satellite bandwidth than that used in DESERT STORM, maneuver elements below division level did not have access to adequate bandwidth and receiver equipment to support their needs. Simply put, the Army is ill equipped to communicate on the move. While it is clear that the Army should seek a greater bandwidth apportionment, it is equally clear that bandwidth is such a precious commodity that demand will always exceed supply. Commercial satellites provided most of the satellite bandwidth used in OIF. This is troubling, since commercial transponders are not protected (secure, anti-jam) and may not be available when needed in future crises.

Modernize GPS space and ground segments. *The Army should encourage the GPS Program Office to continue efforts aimed at modernizing the GPS space and ground segments to make them more resistant to jamming. The Army should also better equip maneuver forces with military specification GPS receivers and other equipment items that employ GPS position, velocity, navigation, and timing data.*

In a future conflict, a more capable adversary equipped with better jammers may be able to employ them with considerable effect. Therefore, the Army should encourage the Program Office and ground segment systems developers to modernize GPS by making it more resistant to jamming. The Army should also procure more military-specification GPS receivers to reduce soldiers' dependence on commercial GPS receivers that are more vulnerable to jamming and spoofing. Maneuver forces need more GPS-related equipment of all types.

Institutionalize Army space support to the warfighter. *The Army should take aggressive action to "normalize" its space operations functions.*

The Space and Missile Defense Command made significant efforts to provide space operations support to ground forces in OIF, and its achievements were impressive. They will also be transitory if the Army fails to standardize, codify, and develop

an infrastructure to support them. Much needs to be done. While it is difficult and often costly to support low-density items such as Space Support Element Toolset–Light and Spectral Exploitation Cell–Transportable in formal procurement and maintenance channels, the Space and Missile Defense Command should examine ways to baseline a standard version of each equipment suite and provide some form of routine logistical support, thereby establishing a standard for operator training and freeing the weapons lab to press ahead in developing more advanced capabilities. The Army should examine its commitment to space operations to ensure the provision of adequate program management and opportunities for professional development.

Battle Damage Assessment

A decade of dueling between Iraqi air defenses and coalition air forces enforcing the southern no-fly zone in Operation SOUTHERN WATCH provided ample opportunity for CENTCOM to hone its processes for battle damage assessment (BDA) in the Iraqi theater. Unfortunately, neither SOUTHERN WATCH nor ENDURING FREEDOM in Afghanistan was adequate preparation for the challenge of providing timely and accurate BDA in a dynamic, high-volume campaign.

In OIF, the BDA process fell behind early, overwhelmed by the volume of the campaign, and struggled to catch up. Despite the best efforts of analysts, the BDA process could not keep up with the pace of operations and failed to adequately inform the decisions of commanders. Turnaround times for BDA were measured in days instead of hours. The uncertainties resulting from these delays adversely affected the planning and operations of all the components.

Improve ground forces BDA. *The Army should actively participate in joint efforts aimed at improving the BDA process. In particular, the Army should take an active role in the activities of the Combat Assessment Working Group, which evaluates the utility of various types of BDA reporting and develops joint tactics, techniques, and procedures (JTTP) and doctrine for ground force BDA.*

The BDA process was one of the most frequently cited shortcomings in after action reviews and lessons-learned reports on the major combat phase of OIF. This attention has generated a great deal of interest in options for improving the process or even scrapping it entirely in favor of new proposals for effects-based assessments. Tasked with developing an integrated plan for solving BDA's problems, the Combat Assessment Working Group⁵ is supposed to re-evaluate the utility of current BDA reporting and develop JTTP and doctrine for ground force BDA.

⁵ The Combat Assessment Working Group was created within the Joint Staff (Deputy Director for Targets, J-2T). Its charter is to improve the combat assessment process (to include BDA).

While the Army should actively participate in both of these activities, it should take a leading role in the development of JTTP for ground force BDA to ensure that future ground force BDA processes and products adequately address the concerns of ground force commanders at all levels. One key question to be addressed is whether BDA analysts should continue to be responsible for assessing the combat effectiveness of enemy units. Combat effectiveness assessments of BDA analysts have often conflicted in the past with those of order-of-battle analysts, who are typically better trained for this task. One potential solution would task BDA analysts to assess damage to equipment and then pass this information along to an order-of-battle cell, which would associate the damage with particular units and assess their combat effectiveness.

Automate information management. *The Army should support joint efforts aimed at developing automated tools for generating and managing the flow of tactical reporting and other useful inputs for BDA.*

In OIF, significant latencies in generating, collating, forwarding, and receiving mission reports were a major source of delay in the BDA process. Most mission reports arrived at CENTCOM late. In the absence of mission reports, BDA analysts did not know what targets had been attacked or where bombs had been dropped.

Several different mission report formats were featured in OIF, which added to the complexity of the information management problem. These reports had to be manually entered into the BDA database. The quality of the reporting was uneven as well, with many mission reports omitting key pieces of information.

A reliable automated system for reporting and information management could have largely eliminated mission report delays.

Audit imagery exploitation. *The joint community should commission a detailed study of the number of image analysts and the supporting imagery exploitation tools and infrastructure required to adequately support BDA and other key intelligence functions in future conflicts.*

In OIF, there were fewer image analysts in theater than were believed to be required to support OPLAN 1003V. This shortfall, combined with a high demand to locate targets, led to an intense competition for limited imagery exploitation assets and additional delays in the BDA process. Imagery exploitation is a key enabling function for modern military operations and should be adequately resourced.

Address BDA training. *The joint community should include more realistic exercises involving BDA as part of its joint training efforts. The Army should encourage the development of and actively participate in exercises of the entire BDA process, including participation by components and federated partners.*

BDA analysis in joint training exercises is generally scripted. This does not adequately stress BDA processes and procedures or provide a good opportunity for ana-

lysts to put their skills to the test. The lack of realistic peacetime training allowed shortcomings in BDA information management systems, processes, and procedures to remain undetected until exposed to wartime stresses. Some of the exercises should include as much of the BDA process as possible, including participation from components and federated partners. Realistic exercises that stress the BDA system should help expose problem areas and potential bottlenecks, as well as provide decisionmakers with a better sense of the capabilities and limitations of BDA.

Information Operations

Information operations have become increasingly important in recent campaigns. The need to limit noncombatant casualties and infrastructure damage means that operations focused on persuading an enemy not to resist are becoming more attractive as alternatives to attacking an enemy with kinetic weapons alone. Likewise, activities such as frequency jamming reduce the enemy's ability to control its forces; hence, friendly forces are more likely to face a relatively ineffectual enemy—this also reduces the likelihood of collateral damage. From psychological operations to computer network operations, information operations are claiming a larger and larger share of a combat commander's decisionmaking time. Thus, IO must be integrated with the overall campaign plan. Several factors contribute to how well IO integrates with other (e.g., kinetic) operations. If IO is to rise to the level of importance envisioned in several Defense Department documents, the IO community must address shortcomings in its processes, support organizations, and ability to measure and report effects.

Push external integration. *Information operations officers at all levels should be included early in planning to allow sufficient time for integrating complementary IO activities with the operations being planned.*

Early inclusion in the planning process allows IO officers to identify where IO can achieve desired effects, rather than simply support other operations. IO officers should also be included in the target nomination process during combat operations.

Facilitate internal integration. *The IO community should publish guidance that prescribes how the various IO capabilities can be employed to full effect in the information environment.*

Integration between and among IO disciplines improved during OIF. However, such integration as occurred took place primarily on the margin. For example, electronic warfare and computer network capabilities were employed in OIF as delivery mechanisms for PSYOP messages.

Expand IO personnel and training. *The Army should plan to increase the number of active and reserve IO personnel and intensify their training. Training for IO officers and ground commanders should include a more extensive introduction to IO tools and the effects they can produce.*

The rapid growth and increasing scope of IO missions underscore the need to ensure a sufficient number of trained men and women. The Army and the other services should also take steps to make the IO career field more attractive.

To facilitate the training process, classified compartments for IO capabilities should be avoided, although IO officers should be cleared for access to compartmented information when necessary.

Develop IO measures of effectiveness. *The Army should develop usable measures of effectiveness for assessing the combat effects of IO.*

Collection assets should be allocated to gathering the evidence needed to inform such measures. The measured results of IO should be regularly reported to commanders, preferably in real time.

Support tactical PSYOP teams. *The Army should allocate additional communications assets to tactical PSYOP teams in order to facilitate reach-back capabilities.*

Alternatively, it should provide them with translation and printing capability in situ. In addition, the approval process for PSYOP messages should be simplified and processing time should be shortened.

Media Coverage

One of the unique aspects of OIF was the reporting from embedded media correspondents that occurred simultaneously with CENTCOM's traditional daily briefings. Embedded reporting was generally considered successful, as measured by the favorable way the military was portrayed in the press. The daily briefings were criticized, however, for being directed primarily to western audiences, thereby forgoing an opportunity to influence the "Arab street."

Continue to embed reporters. *The Army should maintain its support of OASD/PA decisions to embed media representatives with combat units, but before the concept is applied to the next war, the conditions that made it successful in this operation should be thoroughly examined and understood.*

OIF was in many ways the ideal war for embedded news coverage: OASD(PA) had time to prepare an effective media strategy; there was time to design a training program for the embeds; it was possible to take time to determine which units would

receive embedded media; and the poor military capabilities of the Iraqi regime reduced the potential danger to embedded journalists. If the United States were to face a more dangerous adversary with less time to plan, media organizations would most likely be more concerned about the safety of their journalists, and less time would be available to prepare for implementation of the concept.

Supply context for media reporting. *Daily briefings by public affairs officers should provide sufficient overall context for understanding combat operations. Additionally, more tailored information should be supplied to important regional media organizations.*

Embedded media also had an important effect on the context of the CENTCOM briefings in Doha and on public affairs in general. There was absolutely no way to spin combat reports: the media were right there accompanying the fighting forces. By being inside the military's decision cycle, the images and reports filed by embedded media tended to upstage CENTCOM's briefings.

Mobilization

Army mobilization doctrine and processes were designed to generate additional, reserve forces for large-scale operations. OIF's mobilizations, however, did not match the Army's expectations; hence, they required adaptations. Prior mobilizations had been relatively modest in size and thus did not prepare the Army to deal with issues that arose when the scope of the mobilization increased significantly. Consequently, mobilization for OIF suffered from the lack of a well-managed mobilization process.

Improve accountability. *The Army should create system-wide accountability for mobilization and give a single office responsibility for mobilization process design and performance.*

The fragmentation of responsibilities for mobilization in OIF meant that no single organization was responsible for monitoring the Army's mobilization performance and synchronizing mobilization operations with national strategy and higher authorities' directives and procedures. This situation led to surprises, friction, and false starts.

Develop better information systems. *The Army should pursue development of a single information system that supports mobilization of active and reserve components and employs standard concepts and definitions.*

Information systems affect every stage of mobilization, from soldier readiness to unit deployment. OIF mobilizations were hampered by outdated and inadequate information systems. The web-based processes developed later by the mobilization community potentially offer a good model to follow.

Modernize processes and facilities. *Facilities at mobilization stations should be modernized to facilitate processing and to support installation and operation of modernized information systems.*

Improving information systems requires resources for development and fielding. Major mobilization stations should have improved operations centers. Barracks, training, and medical facilities should be held to high standards. Even routine processes such as issuing clothing should be modernized to the standards of 21st century retailing.

Build a new mobilization model. *The Army should develop a new mobilization model that can support major mobilizations, small contingencies, and regular rotations.*

Mobilization planning should not only support major combat operations but also meet the needs of unexpected contingencies and foreseeable rotational deployments. Each type of mobilization calls for a different mobilization concept. For rotational deployments, for example, the Army could consider a “train-mobilize-polish-deploy” model that could save time.

Use the Individual Ready Reserve. *The Army should develop a system that closely monitors IRR personnel and tracks their deployability status, facilitates contacting IRR members, and identifies mismatches between the skills needed and the IRR skills available.*

For OIF the Army had accurate contact data on only about 65 percent of the soldiers in the IRR. Furthermore, evidence suggests that only about 60 percent of those soldiers could be mobilized successfully. Continuing requests for certain skills from the IRR suggest that job category authorizations for the active Army understate its requirements. Finally, the IRR played almost no role in the major combat phase of OIF. It played a relatively minor role afterward, even taking into account an increase in the numbers of IRR soldiers being requested.

Sustainment

Many of the logistics problems that occurred during OIF resulted from one element of the supply chain not being aligned with another. An integrated view of the entire logistical process was needed. That is, OIF lacked a common supply-chain concept or vision that laid out the complementary roles of various levels or echelons of supply and their connecting distribution channels. This common vision was needed to ensure that each process and organization in the chain focused on a common goal. Given an overall supply-chain vision, each element within the chain can define its purpose and focus on its mission. Creating such a vision is difficult because the Army does not control every element of the supply system. Therefore, the Army must work with its supply

chain partners, as well as the distribution process owner, to develop such a common vision of an integrated supply chain.

Improve communications connectivity. *The Army should make improvements in communications connectivity to facilitate the creation of requests, especially during combat operations.*

The ability of units to requisition supplies “on the move” should always be enabled. This need will be met by the post-OIF Army plan to provide all SSAs with mobile satellite communications.

Bolster Supply Support Activities. *The Army should ensure that warehouse capacities of the SSAs that traveled with and directly supported units at the tactical level in OIF, as defined by the number and types of trucks and trailers authorized, are sufficient to meet readiness needs.*

SSA organizational designs should be based upon a standard, detailed readiness analysis during the force development process. Capacity determination should consider the number and depth of parts needed to support each item of equipment and should include storage aids, such as cabinets.

Streamline strategic distribution. *To achieve efficient strategic distribution, the Army should ensure that the SSAs receive pure multipacks.⁶*

The consequences of not having such multipacks rippled across the force in OIF, with units either having to break down pallets and distribute material without having the personnel or information necessary to do so or receiving material they did not order (and not receiving material they did order). Furnishing single or pure SSA multipacks and pallets should be a matter of joint policy as well.

Align theater stocks. *Drawing upon OIF, the Army should develop doctrine and associated policy for theater stocks that focus on readiness and on minimizing the use of airlift.*

The inventory requirements for forward-positioned items should be limited to those items that drive readiness or consume substantial airlift. Simultaneously, the Army needs to improve its methodology for determining requirements for prepositioned stocks.

Facilitate theater distribution and sustainment. *The Army should develop effective, easy-to-use, integrated automation tools to help itself plan and adapt to a complete the-*

⁶ Multipacks are simply boxes that contain smaller packages of parts or supplies. If all the material in a multipack is intended for a single unit, it is said to be pure. The goal is to have the CONUS shipping point prepare pure multipacks.

ater distribution system. The Army should develop integrated, modular theater sustainment capabilities. It lacked these in OIF.

The Joint Deployment Logistics Model and the Battle Command Sustainment Support System have made strides toward these objectives. The capabilities they can provide should be the starting point for any future deployment plan and the development of force packages.

Codify water supply and distribution. *The Army should establish water supply and distribution policies to ensure, in contrast to OIF, that planning and execution mesh in this key area.*

The crucial issue here is to ensure that the policy planned for a contingency such as OIF is the one executed. A policy on whether bottled water will be the preferred option for operations (particularly in the early stage) should be established by the Army's requirements community in coordination with regional combatant commands.

Preposition parts. *The Army should use field readiness data, as archived in the equipment downtime analyzer, to determine its requirements for prepositioned parts. To establish the stock level for each item, the Army should rely on actual demand histories of units in OIF with similar end items. The Army should also align Authorized Stockage List performance metrics to focus only on parts desired for stockage.*

The link between prepositioned parts and readiness should be based on the contribution of these parts to completed repairs rather than the percentage of part requests filled. Such an approach would bring the dependencies among parts needed to complete repairs into the stockage determination process. Storage capacity would be treated either as a constraint (if the number of trucks and trailers is a given) or as an objective (if storage capacity is flexible), thus basing storage requirements for parts on the size of storage locations, not on item sizes. Also, requirement objectives and reorder points could be completed. Finally, prepositioned stocks should be set up as turnkey operations—storing parts that are clearly identified and easy to get to—so that they can be taken from storage and used immediately.

Authorized stocks should be designed to include only those items that are critical to readiness and to exclude items that are difficult to transport and that can be ordered in large quantities for planned events (e.g., change of track).

Forecast contingency demands. *The Army should work to provide the Defense Logistics Agency with accurate and detailed contingency demand requirements, drawn from OIF and other contingencies, in terms of the overall level of demand being projected, how fast requirements might increase, and how long they might continue. The Army should also develop long-term policies for pallet-building at aerial ports of embarkation.*

DLA needs the capability to expand distribution center, consolidation, and containerization point capacity rapidly. Long-term policy development should be linked to the results of a CCP bypass policy and coding analysis. Once the expected long-term pallet-building volume at an APOE is clear, a policy for future contingencies can be developed.

Integrate the supply chain. *Although it did not do so in OIF, the Army should designate a supply chain integrator.*

One organization and leader should know the details of the entire supply and distribution plan in order to ably represent the entire plan as an integrated whole through the contingency planning process.

Set national inventory and production requirements. *As OIF suggested, the Army should develop a standard, accurate, and fast process for changing national inventory and production requirements.*

As key inputs, the combatant commands should provide Headquarters, Department of the Army and Army Materiel Command with a range of potential scenarios.

Improve the parts requirement assessment process. *In the process of obtaining contingency budget approval, the Army should apply risk management techniques to assess requirements for critical parts.*

As OIF showed, long-lead-time items are also important. Not ordering critical parts early enough can lead to significant operational risk. Regional commander and Department of the Army scenario inputs and planning guidance should cover a range of possibilities rather than forcing the process to work from single-point estimates. For each scenario, parts in the high-payoff, low-financial-risk area, and critical, long-lead-time categories, as well as their requirements, should be separately identified.

Reduce lead times. *OIF demonstrated that the Army should accelerate efforts to reduce lead times for administration, production, and repair to reduce Army Materiel Command's replenishment lead times.*

The more these times can be reduced, the fewer tradeoffs have to be made between operational and financial risk.

Improve transition to war processes. *The Army should initiate processes and procedures to ensure that the transition-to-war processes are more agile than they were in OIF.*

Processes, resources, and capacities were insufficiently robust or agile to enable rapid transitions to sustaining units in new locations at higher levels of demand during OIF. Furthermore, key distribution principles need to be further embedded in joint doctrine and tactics, techniques, and practices. Good practices were developed before

and during OIF, and they should not continue as ad hoc practices. Additionally, joint command and control should continue to improve. Further, transactional information systems and processes need to be simplified. Finally, logistics information system resources require a higher priority. Non-line-of-sight, mobile communications are clearly essential for logistics forces, as are the situational awareness tools needed to conduct distribution over extended distances, often over less than completely secured LOCs.

Bibliography

- Al-Hamdani, Lieutenant General Raad, Interview, PBS, *Frontline*, "The Invasion of Iraq," 2004.
- Al-Marashi, Ibrahim, "Iraq's Security and Intelligence Network: A Guide and Analysis," *Middle East Review of International Affairs*, Vol. 6, No. 3, September 2002.
- "Al-Qaeda in Northern Iraq? The Elusive Ansar al-Islam," *IISS Strategic Comments*, Vol. 8, Issue 7, September 2002.
- Albright, Madeleine, *Madam Secretary: A Memoir*, New York: Miramax Books, 2005.
- Anderson, Colonel (USA) Charles A., "Air and Missile Operation," *Army*, January 2004.
- Anderson, Duncan, "The Build-Up," in John Pimlott, *The Gulf War Assessed*, London: Arms and Armour, 1992.
- Anderson, Gerald C., Director, Office of Peacekeeping, U.S. Department of State, Statement to the U.S. House of Representatives, Committee on Energy and Commerce, Subcommittee on Oversight and Investigations, May 16, 1995.
- "Army OIF Report Reveals Emerging Air Defense Challenges, Threats," *Inside the Army*, October 27, 2003.
- Army War College, "Reporters on the Ground: The Military and the Media's Joint Experience During Operation Iraqi Freedom," workshop transcript, September 3–5, 2003.
- Aspin, Les, House Armed Services Committee Memorandum: "From Deterrence to Denuking: Dealing with Proliferation in the 1990s," Washington, D.C.: GPO, February 18, 1992.
- Aukofer, Frank, and William Lawrence, *America's Team: The Odd Couple—A Report on the Relationship Between the Media and the Military*, Nashville, TN: Freedom Forum First Amendment Center, 1995.
- "Ba'ath Party Entrenched in Saddam's Cult of Personality," *The China Post*, April 4, 2003. As of March 2008:
<http://www.culteducation.com/reference/general/general539.html>
- Baker, Peter, "U.S. to Negotiate Capitulation Agreements with Iraqi Military," *Washington Post*, March 18, 2003. As of March 2008:
<http://www-tech.mit.edu/V123/N13/Iraq-military.13w.html>
- Baram, Amatzia, *Between Impediment and Advantage: Saddam's Iraq*, Washington, D.C.: U.S. Institute of Peace, Special Report 34, 1998.
- , "The Effect of Iraqi Sanctions: Statistical Pitfalls and Responsibility," *Middle East Journal*, Vol. 54, No. 2, Spring 2000, pp. 194–223.

———, “Would Saddam Husayn Abdicate?” Iraq Memo #9, Washington, D.C.: The Brookings Institution, February 4, 2003.

Bensahel, Nora, Olga Olikier, Keith Crane, Richard R. Brennan, Jr., Heather S. Gregg, Thomas Sullivan, and Andrew Rathmel, *After Saddam: Prewar Planning and the Occupation of Iraq*, Santa Monica, CA: RAND Corporation, MG-642-A, 2008. As of October 2013:
<http://www.rand.org/pubs/monographs/MG642.html>

Bergeron, Major Wayne, JPOTF Executive Officer, “Joint Psychological Operations Task Force: OEF/OIF,” briefing, undated.

Bernstein, Lewis, and Roy McCullough, “Space and Missile Defense Command Contributions and Lessons from Operation Iraqi Freedom,” *The Army Space Journal*, Vol. 2, No. 3 (Special Edition), 2003.

Betha, Mearen, and Garth Hahn, “1st Satellite Control Battalion: Silent Support to the Warfighter,” *The Army Space Journal*, Vol. 2, No. 3 (Special Edition), 2003.

Biddle, Stephen, et al., “Iraq and the Future of Warfare,” briefing, Strategic Studies Institute, U.S. Army War College, August 18, 2003.

Blair, David, “145 of My 150 Men Fled, Says Guard Officer,” *Daily Telegraph*, April 14, 2003. As of March 2008:
<http://www.telegraph.co.uk/news/main.jhtml?xml=/news/2003/04/17/wguard17.xml>

———, “Why the Fedayeen Fight for Their Lives,” *Daily Telegraph*, March 25, 2003.

Blix, Hans, *Disarming Iraq*, New York: Pantheon Books, 2004.

Bloom, Lieutenant Colonel Bradley, “Information Operations in Support of Special Operations,” *Military Review*, January–February 2004.

Bogdanos, M.E., “Joint Interagency Cooperation: The First Step,” *Joint Forces Quarterly*, Issue 37, Spring 2005.

Bowman, Steve, *Iraq Chemical and Biological Weapons (CBW) Capabilities*, Washington, D.C.: CRS Report for Congress, 98-129F, September 4, 1998.

Boyne, Sean, “Iraq’s Military Purge,” *Jane’s Intelligence Review*, Vol. 8, No. 10, October 1, 1996.

———, “Iraq’s Security Network, Part 1,” *Jane’s Intelligence Review*, Vol. 9, Issue 7, July 1, 1997.

———, “Iraq’s Security Network, Part 2,” *Jane’s Intelligence Review*, Vol. 9, Issue 8, August 1, 1997.

———, “Iraq Retains Ability to Quell Revolts,” *Jane’s Intelligence Review*, January 1, 2002.

Bragg, Rick, *I Am a Soldier, Too, The Jessica Lynch Story*, New York: Alfred A. Knopf, 2003.

Branigin, William, “A Brief, Bitter War for Iraq’s Military Officers,” *The Washington Post*, April 27, 2003.

Brinkley, Joel “Ex-CIA Aides Say Iraq Leader Helped Agency in 90’s Attacks,” *New York Times*, June 9, 2004.

Brown, General Bryan D., Commander of U.S. Special Operations Command, *Testimony Before United States House of Representatives Committee on Armed Services Subcommittee on Terrorism, Unconventional Threats and Capabilities*, March 11, 2004.

Burns, Robert, “Review of Iraq War Finds Some Failures,” *St. Petersburg Times*, October 2, 2003.

Bush, George W., "Remarks at 2002 Graduation Exercise of the United States Military Academy," June 1, 2002. As of March 2008:

<http://www.whitehouse.gov/news/releases/2002/06/20020601-3.html>

"Bush Aides Play Down Effort to Avert War at Last Minute," *New York Times*, November 7, 2003.

Cambone, Stephen A., Under Secretary of Defense (Intelligence), briefing on "Weapons of Mass Destruction Exploitation in Iraq," May 7, 2003. As of March 2008:

www.defenselink.mil/transcripts/2003/tr20030507-0158.html

———, briefing on "The Iraq Survey Group," May 30, 2003. As of March 2008:

www.defenselink.mil/transcripts/2003/tr20030530-0231.html

CAOC, "Operation IRAQI FREEDOM CAOC-PSAB Offensive Ops Team Lessons Learned," draft v8, April 29, 2003.

Casella, Darlene, "A Nation without a Country—Kurdistan," *Family Security Matters*, June 17, 2014.

Caterinicchia, Dan, "DOD Chat Use Exploded in Iraq," *Federal Computer Week*, June 23, 2003.

"CFACC Update" briefings, March 31 to April 4, 2003.

CFLCC, Change 2 to "CFLCC OPLAN COBRA II, Base Plan (13 JAN 02)," February 15, 2003.

———, U.S. Army Forces Central Command, Change 2 to "Annex H to CFLCC OPLAN COBRA II, Stability Operations," February 15, 2003.

———, Intelligence Update, 23 March 2003, 0300Z.

———, "OPLAN ECLIPSE II BASE PLAN," Coordinating Draft, April 12, 2003.

———, "History of the Ground War," briefing, July 2003.

Chandrasekaran, Rajiv, "Iraq Arms Civilians as Second Line of Defense Against U.S.," *Washington Post*, February 5, 2003.

———, "Iraq Seeks Meeting with UN Inspectors," *Washington Post*, March 16, 2003.

Chandrasekaran, Rajiv, and Peter Baker, "Air and Land Offensive Gathers Speed; Marines Seize Major Port in South as Armored Units Speed Through Iraqi Desert Toward Baghdad," *Washington Post*, March 23, 2003.

Chandrasekaran, Rajiv, and Peter Baker, "U.S. Forces Probing Inside Baghdad," *Washington Post*, April 5, 2003.

Chapman, Susan, "The 'War' Before the War," *Air Force Magazine*, February 2004.

Charlton, Lieutenant Colonel John W., "Digital Battle Command: Baptism by Fire," 1-15 IN/3 Infantry Division, July 31, 2003.

"Chemical Clues Found in Northern Iraq," ABC News, April 1, 2003. As of March 2008:

http://web.archive.org/web/20030622225749/http://abclocal.go.com/kgo/news/print_040103_nw_iraq.html

"CIA Expected Iraqis to Wave U.S. Flags After Invasion," *Associated Press*, October 20, 2004.

Coalition Provisional Authority, Orders. As of August 2013:

<http://www.iraqcoalition.org/regulations/#Orders>

———, Regulations. As of August 2013:

<http://www.iraqcoalition.org/regulations/#Regulations>

Cohen, Eliot, and Thomas A. Keaney, *Gulf War Air Power Survey*, Washington, D.C.: Department of Defense, 1993.

Cole, Juan, "The United States and Shi'ite Religious Factions in Post-Ba'athist Iraq," *Middle East Journal*, Vol. 57, No. 4, Autumn 2003.

Coll, Steve, "Hussein Was Sure of Own Survival; Aide Says Confusion Reigned on Eve of War," *Washington Post*, November 3, 2003.

Colon, Arnaldo, Capt. (USMC) Command Historian, 26th Marine Expeditionary Unit, "U.S. Marines in North Iraq: A Certain Force," undated.

COMCFSOCC, "Guidance on 8 March 2003 (CONOP for 173rd ABN BDE in Northern IZ)," presentation, March 8, 2003.

COMCFSOCC J3 to CJSOTF-N J3, "Seizure of Kirkuk CONOP," message, 090850Z APR 03.

Conetta, Carl, "Catastrophic Interdiction: Air Power and the Collapse of the Iraqi Field Army in the 2003 War," *Air Force Magazine*, September 26, 2003.

Conway, Lieutenant General James, Commander, 1st Marine Expeditionary Force, Interview, PBS, Frontline, "The Invasion of Iraq," 2004.

Cook, Nick, "Military Priorities and Future Warfare," *Jane's Defence Weekly*, September 11, 2002.

Cooper, Christopher, and David Cloud, "Branches of U.S. Military Fight over Air Time and Credit: A Final Battle over Budgets?" *Wall Street Journal*, March 26, 2003.

Cordesman, Anthony H., *Lessons of the Gulf War: 1990–1991*, Washington, D.C.: Center for Strategic and International Studies, 1994.

———, *USCENTCOM and Its Area of Operations*, Washington, D.C.: Center for Strategic and International Studies, April 1998.

Cornwell, Rupert, "U.S.-Backed Iraqis Launch Bid for Power," *Independent* (London), April 13, 2003.

Council on Foreign Relations, "Iraq: What Is the Fedayeen Saddam?" March 31, 2003. As of March 2008:

<http://www.cfr.org/publication/7698/>

"Cracks Within Iraq's Army," *Jane's Intelligence Review*, November 1, 1994.

Crawley, James W., "SEALs Give Glimpse of Missions in Iraq," *San Diego Union-Tribune*, June 27, 2003.

Defense Threat Reduction Agency (DTRA), "Site Assessment Team (SAT)," March 2003 briefing.

Denny, David Anthony, "New WMD Survey Group to Begin Operation in Iraq Soon," The Washington File, Bureau of International Information Programs, U.S. Department of State, May 30, 2003. As of May 2014:

<http://iipdigital.usembassy.gov/st/english/article/2003/05/20030530183207yynnedd0.2583277.html>

Diamond, John, "Powell Expands List of Facilities in Iraq That May Be Bombed," *NCI*, March 8, 2001.

Dobbins, James, et al., *America's Role in Nation-Building: From Germany to Iraq*, Santa Monica, CA: RAND Corporation, MR-1753-RC, 2003. As of October 2013:

http://www.rand.org/pubs/monograph_reports/MR1753.html

Dodge, Toby, *Inventing Iraq: The Failure of Nation Building and a History Denied*, New York: Columbia University Press, 2003.

Duelfer, Charles, *Comprehensive Report of the Special Adviser to the DCI on Iraq's WMD*, Vol. I, September 30, 2004.

Ebbutt, Giles, "Blue Force Tracking by Northrop Grumman," *Jane's International Defence Review*, December 1, 2003.

Edmonson, George, "Inspections: Hunt for Banned Weapons Ongoing," *The Atlanta Journal-Constitution*, April 15, 2003.

Eisenstadt, Michael, *Like a Phoenix from the Ashes: The Future of Iraqi Military Power*, Washington, D.C.: Washington Institute for Near East Policy, 1993.

Ekeus, Rolf, "Iraq's Real Weapons Threat," *Washington Post*, June 29, 2003.

ENDURING FREEDOM Combat Assessment Team, "Initial Observations Report, Operation IRAQI FREEDOM: Command and Control of Aircraft and Missiles," Quantico, VA: Commandant of the Marine Corps, November 2003.

"Excerpts from Iraqi Transcripts of Meeting with U.S. Envoy," *New York Times*, September 23, 1990.

Fallows, James, "Blind into Baghdad," *Atlantic Monthly*, January/February 2004.

Fallows, James, Interview, PBS, *Frontline*: "Invasion of Iraq," 2004.

FBIS Trends, FB TM 91-002, January 10, 1991, p. 2.

15th Air Support Operations Squadron, "3rd ID CAS BDA Results," spreadsheet, Fort Stewart, Georgia, undated. Not available to the general public.

Fineman, Mark, Robin Wright, and Doyle McManus, "Preparing for War, Stumbling to Peace," *Los Angeles Times*, July 18, 2003.

Finn, Peter, "New Force Moves to Gain Sway," *Washington Post*, April 12, 2003.

———, "Pentagon's Iraqi Proteges Go Home to Mixed Welcome," *Washington Post*, April 17, 2004.

1st Marine Division, *After Action Report, 1st Marine Division, Operation Iraqi Freedom*, Camp Pendleton, California, 2003.

———, "Operation Iraqi Freedom (OIF) Lessons Learned," May 2003. As of June 2004:
http://www.globalsecurity.org/military/library/report/2003/1mardiv_oif_lessons_learned.doc

Fisk, Robert, "Ruling the Airwaves—How America Demoralised Iraq's Army," *The Independent*, May 27, 2003.

Fitchett, Joseph, "In UN Report, Ammunition for 2 Sides," *International Herald Tribune*, January 28, 2003.

Flick, Darrin M., CWO 2, "Memorandum for the Record; Case of Al Tuwaitha," April 11, 2003.

Fontenot, Colonel (USA ret.) Gregory, Lieutenant Colonel (USA) E.J. Degen, and Lieutenant Colonel (USA) David Tohn, *On Point: The United States Army in Operation Iraqi Freedom*, Fort Leavenworth, KS: Combat Studies Institute Press, 2004.

Food and Agricultural Organization, Global Information and Early Warning System, *FAO/WFP Food Supply and Nutrition Assessment Mission to Iraq*, Rome: FAO, 1997.

"France Denies Coaxing Saddam on Invasion," *Associated Press*, November 4, 2003.

Franks, Tommy, *American Soldier*, New York: Regan Books, 2004.

Friedman, Herbert A., "Operation Iraqi Freedom," April 29, 2004. As of March 2008:
<http://www.psywarrior.com/OpnIraqiFreedom.html>

Fulgham, David A., "Stealth UAV Goes to War," *Aviation Week & Space Technology*, July 7, 2003.

Galloway, Joseph, "General Tommy Franks Discusses Conducting the War in Iraq," *Knight Ridder*, June 19, 2003.

"GAO/IMTEC-92-26 Patriot Missile Software Problem," GAO, February 4, 1992. As of March 2008:

<http://www.fas.org/spp/starwars/gao/im92026.htm>

Garamone, Jim, "Transformation on Display in Qatar," *American Forces Information Service*, December 2002. As of July 20, 2004:

<http://www.dod.gov/news/Dec2002>

Gellman, Barton, "Hunt for Iraqi Arms Erodes Assumptions," *Washington Post*, April 22, 2003.

———, "Frustrated, U.S. Arms Team to Leave Iraq," *Washington Post*, May 11, 2003.

———, "Odyssey of Frustration—In Search for Weapons, Army Team Finds Vacuum Cleaners," *Washington Post*, May 18, 2003.

———, "Covert Unit Hunted for Iraqi Arms," *Washington Post*, June 13, 2003.

Gerlin, Andrea, "Iraqi Opposition Groups Agree on Power-Sharing Plan," *Philadelphia Inquirer*, December 18, 2002.

Girardini, Kenneth, Art Lackey, Kristin Leuschner, Daniel A. Relles, Mark Totten, and Darlene J. Blake, *Dollar Cost Banding: A New Algorithm for Computing Inventory Levels for Army SSAs*, Santa Monica, CA: RAND Corporation, MG-128-A, 2004. As of October 2013:

<http://www.rand.org/pubs/monographs/MG128.html>

GlobalSecurity.org, "All Source Analysis System [ASAS]," undated. As of March 2008:

<http://www.globalsecurity.org/intell/systems/asas.htm>

———, "U.S. Forces Order of Battle," June 25, 2003. As of March 2008:

http://www.globalsecurity.org/military/ops/iraq_orbat_toe_030625.htm

———, "Iraqi Ground Forces Equipment," August 21, 2003. As of March 2008:

<http://www.globalsecurity.org/military/world/iraq/ground-equipment-intro.htm>

———, "Combined Joint Task Force 180," April 2004. As of March 2008:

<http://www.globalsecurity.org/military/agency/dod/jtf-180.htm>

———, "Saddam's Martyrs ["Men of Sacrifice"] Fedayeen Saddam," June 10, 2004. As of March 2008:

<http://www.globalsecurity.org/intell/world/iraq/fedayeen.htm>

———, "Special Republican Guard," June 10, 2004. As of March 2008:

<http://www.globalsecurity.org/intell/world/iraq/srg.htm>

———, "H-3" Airfield," June 22, 2005. As of April 2008:

<http://www.globalsecurity.org/military/world/iraq/h-3-new.htm>

Godson, Roy, Ernest R. May, and Gary Schmitt, *U.S. Intelligence at the Crossroads*, Washington, D.C.: National Strategy Information Center, Inc., 1995.

Goebel, Lieutenant Colonel (USAF) Douglas J., *Military-Media Relations: The Future Media Environment and Its Influence on Military Operations*, Maxwell Air Force Base, AL: Air War College and Air University, 1997.

- Goldstein, Eric, *Endless Torment: The 1991 Uprising in Iraq and Its Aftermath*, New York: Human Rights Watch, 1992.
- Gordon, Michael, "Bush Would Stop U.S. Peacekeeping in Balkan Fights," *New York Times*, October 21, 2000.
- , "Iraqi Opposition Groups Meet Bush Aides," *New York Times*, August 10, 2002.
- , "Iraqi Opposition Gets U.S. Pledge to Oust Hussein for a Democracy," *New York Times*, August 11, 2002.
- , "The Goal Is Baghdad, but at What Cost?" *New York Times*, March 25, 2003.
- Gordon, Michael, and Bernard E. Trainor, *The Generals' War: The Inside Story of the Conflict in the Gulf*, Boston: Little, Brown, and Company, 1995.
- Gordon, Phillip H., and Jeremy Shapiro, *Allies at War: America, Europe, and the Crisis Over Iraq*, New York: McGraw-Hill, 2004.
- Grant, Rebecca, "Marine Air in the Mainstream," *Air Force Magazine*, June 2004, pp. 60–64.
- Graham, Bradley, "U.S. Soldiers Cleared in Downing of British Jet," *Washington Post*, May 18, 2004.
- Gray, Lieutenant Colonel (USAF) Steve, "Evolving FSCM/Air C2 Issues: An Air Combat Command Perspective," HQ USAF/ACC briefing, October 30, 2003.
- Hailston, Earl B. (USMC), Commander, MARCENT, briefing, April 24, 2003.
- Headquarters, 2nd Marine Expeditionary Brigade, "Chronicle of the Combat Actions at Nasiriyah," Camp LeJeune, North Carolina, 2003.
- Henderson, Eric, "Space Support Cell: Riding Space in the Iron Horse Division," *The Army Space Journal*, Vol. 2, No. 3 (Special Edition), 2003.
- Hollis, Patricia Slayden, "CENTCOM: Targeting in a Unified Command," *Field Artillery*, May–June 2001.
- Hosenball, Mark, "Iraq: What in the World Was Saddam Thinking?" *Newsweek*, September 15, 2003.
- Hosmer, Stephen T., *Effects of the Coalition Air Campaign Against Iraqi Ground Forces in the Gulf War*, Santa Monica, CA: RAND Corporation, MR-305/1-AF, 2002.
- House of Commons Defence Committee, *Lessons of Iraq: Third Report of Session 2003–2004*, Vol. I, London: The Stationery Office Limited, 2004.
- Howard, Michael, "Conference Delegates Vie for Political Role in New Iraq," *The Guardian* (London), December 16, 2002.
- Hughes, Robin, "USA Addresses Basing Options in Gulf Region," *Jane's Defence Weekly*, September 25, 2002.
- Indyk, Martin, "The Clinton Administration's Approach to the Middle East," Soref Symposium, The Washington Institute for Near East Policy, May 18, 1993.
- "INSI Newsflash: Iraq War Toll Rises Inexorably," *International News Safety Institute Bulletin*, November 3, 2004.
- "Iraq-Military Security Service," *Intelligence Monitor*, August 1, 1996.

Iraq Survey Group, "Scope Note," *Weapons of Mass Destruction (WMD): Iraq Survey Group Final Report*, Vol. I, GlobalSecurity.org, September 30, 2004. As of March 2008:
<http://www.globalsecurity.org/wmd/library/report/2004/isg-final-report/>

Isby, David C., "Iraqi Seersucker Attacks Boost US Cruise Missile Defense Plan," *Jane's Information Group*, August 1, 2003.

Jabar, Faleh A., "Clerics, Tribes, Ideologues and Urban Dwellers in the South of Iraq: The Potential for Rebellion," *The Adelphi Papers*, Vol. 354, No. 1, April 17, 2003, pp. 161–178.

Jaffe, Greg, "On a Remote Base, U.S. Drill Sergeants Train Iraqi Exiles," *Wall Street Journal*, February 24, 2003.

Jane's Security and Foreign Forces, Iraq, January 29, 2002.

"Jay Garner's November 25th Interview with the BBC," *Associated Press*, November 26, 2003.

Jehl, Douglas, with Dexter Filkins, "U.S. Moved to Undermine Iraqi Military Before War," *New York Times*, August 10, 2003.

"Joint Operational Fires: A 1st BCD Perspective from Operation Iraqi Freedom," briefing presented at the Field Artillery and Joint Fires Conference, October 2003.

Joint Staff, "Patriot Missile Capabilities—Pac-2/Upgrades," briefing, undated.

Josar, David, "V Corps Shifting Headquarters from Kuwait to Baghdad Area," *European Stars and Stripes*, April 27, 2003.

Kampfner, John, "The Truth About Jessica Lynch," *The Guardian*, London, May 15, 2003.

Katovsky, Bill, and Timothy Carlson, *Embedded: The Media at War in Iraq, An Oral History*, Guilford, CT: Lyons Press, 2003.

Katzman, Kenneth, *Iraq's Opposition Movements*, Washington, D.C.: CRS Report for Congress, June 27, 2000.

———, *Iraq: U.S. Regime Change Efforts and Post-Saddam Governance*, Washington, D.C.: CRS, January 7, 2004.

Kaufman, Gail, "U.S. UAVs Prove Their Mettle in Iraq," *Defense News.com*, May 21, 2003.

Keaney, Thomas A., *The Gulf War Air Power Survey*, Vol. 2, *Operations and Effects and Effectiveness*, Washington, D.C.: GPO, 1993.

Keaney, Thomas A., and Eliot A. Cohen, *Gulf War Air Power Survey, Summary Report*, Washington D.C.: Government Printing Office, 1993.

Keehan, Michael L., Technical Sergeant, Tactical Air Control Party, 3-7th Cavalry, 3rd Infantry Division (Mechanized), *After Action Report*, undated.

Kelly, General John F., "Tikrit, South to Babylon," *Marine Corps Gazette*, February 2004.

Kelly, Matt, "Military Investigating Whether Patriot Batteries Mistook Coalition Planes for Missiles," *Associated Press*, May 7, 2003.

Kenyon, Henry S., "Unconventional Information Operations Shorten Wars," *Signal*, August 2003.

Kifner, John, and Ian Fisher, "Marines End Role in Iraq's Capital as Army Moves In," *New York Times*, April 21, 2003.

Knickmeyer, Ellen, "Sandstorm Brings Forces to Grinding Halt," *Washington Times*, March 25, 2003.

Koch, Andrew, "Information Warfare Tools Rolled Out in Iraq," *Jane's Defence Weekly*, August 6, 2003.

Kozaryn, Linda D., "Deadly Cards Help Troops Identify Regime's Most Wanted," Armed Forces Press Service, April 12, 2003.

Larson, Eric V., Richard E. Darilek, Dalia Dassa Kaye, Forrest E. Morgan, Brian Nichiporuk, Diana Dunham-Scott, Cathryn Quantic Thurston, and Kristin J. Leuschner, *Understanding Commanders' Information Needs for Influence Operations*, Santa Monica, CA: RAND Corporation, MG-656-A, 2009. As of October 2013:
<http://www.rand.org/pubs/monographs/MG656.html>

Larson, Eric V., Richard E. Darilek, Daniel Gibran, Brian Nichiporuk, Amy Richardson, Lowell H. Schwartz, and Cathryn Quantic Thurston, *Foundations of Effective Influence Operations: A Framework for Enhancing Army Capabilities*, Santa Monica, CA: RAND Corporation, MG-654-A, 2009. As of October 2013:
<http://www.rand.org/pubs/monographs/MG654.html>

LeBor, Adam, "Exiles Prepare for a Happy Return at Camp Freedom," *The Times* (London), February 24, 2003.

Lee, Colonel James, Support Operations Officer, 377th Theater Support Command, email, July 20, 2004.

Lennox, Duncan (ed.), "FROG 7 (M21/52,R-65/70 Luna-M)," *Jane's Strategic Weapons Systems*, Surrey, UK: Jane's Information Group Inc., January 2004.

Lewis, Matt, "Smart Sanctions: Shifting the Blame," Washington, D.C.: Center for Defense Information, June 25, 2001.

Livingston, Gary, *An Nasiriyah, The Fight for the Bridges*, North Topsail Island, NC: Caisson Press, 2004, p. 63.

Loeb, Vernon, "Patriot Downs RAF Fighter," *Washington Post*, March 24, 2003.

Livingston, Gary, and Thomas E. Ricks, "Questions Raised About Invasion Force: Some Ex-Gulf War Commanders Say U.S. Needs More Troops, Another Armored Division," *Washington Post*, March 25, 2003.

MacAskill, Ewen, and Julian Borger, "Iraq 'to Allow Arms Inspectors,'" *The Guardian Weekly* (London), May 2–8, 2002.

MacFarquhar, Neil, "Hussein, in Rallying His Military, Also Shows Iraqis a Defiant Face," *New York Times*, March 7, 2005.

Makiya, Kanan, "The Fedayeen Saddam Keep Shia Intifada in Check," *New Perspectives Quarterly*, Vol. 21, No. 3, Summer 2004.

Martin, Paul, "Iraqi Defense Chief Argued with Saddam," *Washington Times*, September 21, 2003.
"MAWTS-1 Lessons Learned (MAWTS-1 LL)," Marine Aviation Weapons and Tactics Squadron Lessons Learned Report, April 2003.

McGregor, Andrew, "Al-Azhar, Egyptian Islam and the War in Iraq," *Terrorism Monitor*, Vol. 2, Issue 12, The Jamestown Foundation, June 17, 2004.

McKiernan, Lieutenant General David, "Operation Iraqi Freedom," U.S. Department of Defense press briefing, Baghdad, Iraq, April 23, 2003.

McLane, Brendan, "Reporting from the Sandstorm: An Appraisal of Embedding," *Parameters*, Vol. 34, No. 1, 2004.

Mercer, First Lieutenant (USMC) Christopher, "Charlie Company Leads BLT into Northern Iraq," 26MEU Public Affairs Office, 2003.

Meyers, Steven Lee, "At Airport, Bombs Provide the Only Light," *New York Times*, April 4, 2003.

"Military Bases That U.S. Could Use," *Associated Press*, Military.com, September 26, 2001.

Miller, Judith, "Iraqi Leadership Team to Prepare for a Transition to Democracy," *New York Times*, February 28, 2003.

———, "Ending Conference, Iraqi Dissidents Insist on Self-Government," *New York Times*, March 3, 2003.

———, "Chemical Biological Intelligence Support Team," *New York Times*, March 23, 2003.

———, "Special Team Seeks Clues to Establish War Crimes," *New York Times*, March 31, 2003.

———, "Smoking Gun Still Proves to Be Elusive for Searchers," *New York Times*, April 2, 2003.

———, "Evidence Contradicts Rumors of Torture," *New York Times*, April 7, 2003.

———, "Hunt Finds Hint of How Iraqis Fill Power Void," *New York Times*, April 10, 2003.

———, "U.S. Inspectors Find No Forbidden Weapons at Iraqi Arms Plant," *New York Times*, April 16, 2003.

———, "Focus Shifts from Weapons to the People Behind Them," *New York Times*, April 23, 2003.

———, "Illicit Arms Kept Till Eve of War, an Iraqi Scientist Is Said to Assert," *New York Times*, April 21, 2003.

Moore, Molly, "A Foe That Collapsed from Within," *Washington Post*, July 20, 2003.

Moore, Robin, *Hunting Down Saddam: The Inside Story of the Search and Capture*, New York: St. Martin's Press, 2004.

Moseley, Lieutenant General (USAF) T. Michael, Commander, U.S. CENTAF, Assessment and Analysis Division, "Operation IRAQI FREEDOM—By the Numbers," April 30, 2003. As of March 2008:

http://www.globalsecurity.org/military/library/report/2003/uscentaf_oif_report_30apr2003.pdf

Murray, Williamson, and Robert H. Scales, Jr., *The Iraq War*, Cambridge: Harvard University Press, 2003.

Nardulli, Bruce, Walter Perry, et al., *Disjointed War: Military Operations in Kosovo, 1999*, Santa Monica, CA: RAND Corporation, MR-1406-A, 2002. As of October 2013:

http://www.rand.org/pubs/monograph_reports/MR1406.html

NSWTG CENT, "Supporting Plan to COMSOCCENT 1003V Supporting Plan," undated.

Office of the Chief of Army Reserve, Mobilization tracking spreadsheet, undated.

"Officials: UAV Lessons Among the Most Vital Gleaned in Iraq War," *Inside the Pentagon*, July 17, 2003.

O'Neill, Paul, interview with CBS correspondent Leslie Stahl, January 11, 2004.

"Open Letter to the President," February 19, 1998. As of March 2008:

<http://www.iraqwatch.org/perspectives/rumsfeld-openletter.htm>

Operation Iraqi Freedom: Third Infantry Division (Mechanized), "Rock of the Marne" After Action Report, Final Draft, May 12, 2003.

Parks, Scott, "1st Space Brigade (Provisional): Brigade Operations During the War," *The Army Space Journal*, Vol. 2, No. 3 (Special Edition), 2003.

Paul, Christopher, and James J. Kim, *Reporters on the Battlefield: The Embedded Press System in Historical Context*, Santa Monica, CA: RAND Corporation, MG-200-RC, 2004. As of October 2013:

<http://www.rand.org/pubs/monographs/MG200.html>

Peltz, Eric, John M. Halliday, Marc L. Robbins, and Kenneth J. Girardini, *Sustainment of Army Forces in Operation Iraqi Freedom: Battlefield Logistics and Effects on Operations*, Santa Monica, CA: RAND Corporation, MG-344-A, 2006. As of October 2013:

www.rand.org/pubs/monographs/MG344.html

Peltz, Eric, Marc L. Robbins, Kenneth J. Girardini, Rick Eden, John M. Halliday, and Jeffrey Angers, *Sustainment of Army Forces in Operation Iraqi Freedom: Major Findings and Recommendations*, Santa Monica, CA: RAND Corporation, MG-342-A, 2006. As of October 2013:

<http://www.rand.org/pubs/monographs/MG342.html>

Peterson, Lieutenant Colonel Steven W., "Central but Inadequate: The Application of Theory in Operation Iraqi Freedom," a paper presented in partial completion of the course of study at the National Defense University, undated.

Peterson, Scott, and Peter Ford, "From Iraqi Officers, Three Tales of Shock and Defeat," *Christian Science Monitor*, April 18, 2003.

Pirnie, Bruce, *Civilians and Soldiers: Achieving Better Coordination*, Santa Monica, CA: RAND Corporation, MR-1026-SRF, 1998. As of October 2013:

http://www.rand.org/pubs/monograph_reports/MR1026.html

Plante, Chris, "U.S. Civilians Take on Greater Role in Iraq," *CNN*, May 12, 2003.

Plentl, Lieutenant Colonel (USAF) Brett, "Implementing the Net-Centric CAF," briefing, August 14, 2003.

Pollack, Kenneth M., *The Threatening Storm: The Case for Invading Iraq*, New York: Random House, 2002.

Powell, Colin, *Testimony of Secretary of State at Hearing of the House International Relations Committee*, Washington, D.C.: GPO, March 7, 2001.

Powell, Dave, LTC, "OPERATION IRAQI FREEDOM Rock Drill," briefing on DESERT STORM Truck Deployments, 1992.

Prados, Alfred B., and Kenneth Katzman, *Iraqi-U.S. Confrontation*, Washington, D.C.: Congressional Research Service, 2001.

Price, Lieutenant Colonel Vincent L., Major Dale E. Owen, and Chief Warrant Officer Richard L. Gonzales, "75th FA Brigade: SOSO in OIF and BCT at the NTC," *Field Artillery Journal*, March–June 2004.

Priest, Dana, "As Iraqis Flee to Syria, U.S. Nets Scientist," *Washington Post*, April 15, 2003.

Quimby, Debbie, "ERDC Contributes to Operation Iraqi Freedom from the Home Front," *ERDC Information Bulletin*, December 5, 2003.

Rathmell, Andrew, "Iraq's Military—Waiting for Change," *Jane's Intelligence Review*, Vol. 7, No. 2, February 1995.

Reade, David, "Venerable P-3 Aircraft Increases Awareness on the Battlefield," *Sea Power Magazine*, June 11, 2003.

- Reel, Monte, "Garner Arrives in Iraq to Begin Reconstruction," *Washington Post*, April 22, 2003.
- Reinert, Patty, "Bush Admits Wanting New Iraq Regime Before 9/11," *Houston Chronicle*, January 13, 2004.
- Rice, Condoleezza, "Promoting the National Interest," *Foreign Affairs*, January/February 2000.
- Richter, Paul, "Congress Calling for Clarity on Iraq," *Los Angeles Times*, July 31, 2002.
- Ricks, Thomas E., *Fiasco: The American Military Experience in Iraq*, New York: Penguin Press, 2006.
- Riggs, Robert, "Blue on Blue, How Did an Army Patriot Missile Battery Shoot Down a Navy F-18?" Columbia Broadcasting System, February 5, 2004.
- Ripley, Tim, "U.S. to Move Headquarters Out of Saudi Arabia," *Jane's Defence Weekly*, May 7, 2003.
- Risen, James, "Baghdad Scrambled to Offer Deal to U.S. as War Loomed," *New York Times*, November 5, 2003.
- Robbins, Marc, Patricia Boren, and Kristin J. Leuschner, *The Strategic Distribution System in Support of Operation Enduring Freedom*, Santa Monica, CA: RAND Corporation, DB-428-USTC/DLA, 2004. As October 2013:
http://www.rand.org/pubs/documented_briefings/DB428.html
- Robinson, Linda, *Masters of Chaos: The Secret History of Special Forces*, New York: Public Affairs, 2004.
- Robinson, Simon, "A WMD Warehouse in Baghdad?" *TIME*, April 8, 2003.
- Sachs, Susan, "A Former Iraqi Officer Denied His Old Post, Fumes at the U.S.," *New York Times*, November 2, 2003.
- Sadler, Brent, *The Unfinished War: A Decade Since Desert Storm*, CNN Special Report, January 16, 2001.
- Salmoni, Barak A., "Strategic Partners or Estranged Allies: Turkey, the United States, and Operation Iraqi Freedom," *Strategic Insights*, Vol. II, Issue 7, July 2004.
- Sammari, General Wafie, Interview, PBS, *Frontline*, "The Gulf War: An Oral History," January 28, 1997.
- Samson, Victoria, "The PATRIOT/TORNADO Fratricide: It Could Happen Again," Center for Defense Information.
- Savidge, Martin, "Fight Turns Fatal at Key Bridge," *CNN*, April 7, 2003.
- Scales, Brigadier General Robert H., Jr., Director, Desert Storm Project, *United States Army in the Gulf War: Certain Victory*, Washington, D.C.: Office of the Chief of Staff, United States Army, 1993.
- Scarborough, Rowan, "U.S. Seeks Surrender of Iraqi Leaders," *Washington Times*, March 17, 2003.
- , "Special Ops Say Lives Were on Line in Lynch's Rescue," *Washington Times*, June 9, 2003.
- Schaaber, Major M., Captain S. Hedberg, and T. Wesson, "V CORPS: C4ISR Integration AAR: V (US) Corps Assault Command Post," May 2003.
- Schiesel, Seth, "On the Ground in Iraq: The Best Compass Is in the Sky," *New York Times*, April 17, 2003.
- Schmitt, Eric, "Air Power Alone Can't Defeat Iraq, Rumsfeld Asserts," *New York Times*, July 31, 2002.
- Sciolino, Elaine, "Greater U.S. Effort Backed to Oust Iraqi," *New York Times*, June 2, 1992.

- 2nd Space Operations Squadron, "GETS Performance Improvement in SW Asia: 20 Mar–16 Apr 2003," briefing, undated.
- Selinger, Marc, "U.S. Says More Than 10 Types of UAVs in Iraq War, Official Says," *Aerospace Daily*, March 27, 2003.
- Shaddid, Anthony, "Iraqi Officials Emerge, Bolstered by U.S. Setbacks," *Washington Post*, March 24, 2003.
- , "Hussein's Baghdad Falls," *Washington Post*, April 10, 2003.
- , "For Iraq's Leaders and Loyalists, a Vanishing Act," *Washington Post*, April 12, 2003.
- Shanker, Thom, "How Green Berets Overcame the Odds at an Iraqi Alamo," *New York Times*, September 22, 2003.
- , "Regime Thought War Unlikely, Iraqis Tell U.S.," *New York Times*, February 12, 2004.
- , "Hussein's Agents Are Behind Attacks in Iraq, Pentagon Finds," *New York Times*, April 29, 2004.
- Sheridan, Mary Beth, "Ground Fire Repels Copter Assault," *Washington Post*, March 25, 2003.
- Shultz, Richard H., Jr., "The Post-Conflict Use of Military Forces: Lessons from Panama, 1989–91," *The Journal of Strategic Studies*, June 1993.
- Sirak, Michael, "How Does the Patriot System Work?," *Jane's Defence Weekly*, April 9, 2003.
- Slevin, Peter, "Iraqi Opposition Pledges Anti-Hussein Unity," *Washington Post*, August 10, 2002.
- Slocombe, Walter B., "To Build an Army," *Washington Post*, November 5, 2003.
- Smith, Gareth, "Emboldened Opposition Gathers," *Financial Times*, February 27, 2003.
- "Soldiers Find—Again—They Need Faster, Easier Access to GPS," *Inside The Army*, June 30, 2003.
- Souder, Jeffrey, "Space Support Element Toolset, etc. . . . Rapid Prototyping Support to Army Space Forces," *The Army Space Journal*, Vol. 2, No. 3 (Special Edition), 2003.
- Stafford, Lieutenant Colonel Christopher, former commander 9th Information Warfare Flight, "Information Warfare" brief, September 24, 2005.
- Stalinsky, Steven, "Arab and Muslim Jihad Fighters in Iraq," *MEMRI*, Special Report No. 19, July 27, 2003. As of May 2005:
<http://www.memri.org/bin/opener.cgi?Page=archives&ID=SR1903>
- Stone, Andrea, "Patriot Missile: Friend or Foe to Allied Troops," *USA Today*, April 15, 2003, p. 6.
- Suskind, Ron, *The Price of Loyalty: George W. Bush, the White House and the Education of Paul O'Neill*, New York: Simon and Schuster, 2004.
- "The War So Far," *Washington Post*, March 23, 2004, p. A34.
- The White House, "The National Security Strategy of the United States," September 2002. As of March 2008:
<http://www.whitehouse.gov/nsc/nss.pdf>
- 3rd COSCOM, "Common User Lift Trucks" spreadsheet, 2004.
- , daily Commander update briefings, 2004.
- 32nd Army Air and Missile Defense Command, "Operation Iraqi Freedom: Theater Army Air and Missile Defense History," September 2003.

Thomas, Evan, and Daniel Klaidman, "The War Room," *Newsweek*, March 31, 2003.

"Too Many Drones?" *Defense Technology*, December 23, 2003. As of May 28, 2014:
<http://defensetech.org/2003/12/23/too-many-drones/>

Traynor, Ian, "U.S. Closes Exiles Training Camp After Only 100 Show Up," *The Guardian* (London), April 2, 2003.

"Treachery: How Iraq Went to War Against Saddam," *London Sunday Times*, January 11, 2004.

Tyler, Patrick, "Plan on Iraq Coup Told to Congress," *New York Times*, February 9, 1992.

Ullman, Harlan K., and James P. Wade, "Shock and Awe, Achieving Rapid Dominance," Washington, D.C.: National Defense University, 1996, with participation of Admiral (USN) Leon A. Edney, General (USA) Fred M. Franks, and General (USAF) Charles A. Horner.

UK Ministry of Defence, "Aircraft Accident to Royal Air Force Tornado GR MK4A ZG710," London, England: Directorate of Air Staff, 2003.

———, *Operations in Iraq—First Reflections*, London: Ministry of Defence UK, July 2003.

———, *Operations in Iraq—Lessons for the Future*, London: Ministry of Defence UK, December 2003.

United Nations, "Security Council Resolution 661," August 6, 1990.

———, "Security Council Resolution 687," April 3, 1991.

———, "Security Council Resolution 688," April 5, 1991.

———, "Security Council Resolution 1441," December 20, 2002.

———, "UNMOVIC Chronology of Main Events," 2003. As of March 2008:
<http://www.un.org/Depts/unmovic/chronology/Chron.html>

U.S. Army Intelligence Center and Fort Huachuca, *Intelligence Officer's Battlebook*, June 26, 2003.

U.S. Army Materiel Command, "Theater Logistics in the Gulf War," 1994.

U.S. Army V Corps, "V Corps, The Road to 'Victory!' in Operation Iraqi Freedom," V Corps briefing, Heidelberg, Germany, June 2003.

U.S. CENTAF, "Time Sensitive Targeting: Operation Iraqi Freedom," briefing, May 2003.

U.S. CENTCOM, "JSTARS Concept of Operations," April 2001.

———, "CENTCOM BDA SOP," Appendix H, September 2001.

———, "Briefing with CENTCOM Commander General Tommy Franks: Military Operations in Iraq," News Release, March 22, 2003.

———, "Memorandum, Subject: Investigation of Suspected Friendly Fire Incident Near An Nasiriyah, Iraq, 23 March 2003," MacDill Air Force Base, Florida, March 6, 2004.

U.S. Department of the Army, *U.S. Army Official Report on 507th Maintenance Co.: An Nasiriyah, Iraq*, Washington, D.C.: GPO, 2003.

U.S. Department of Defense, *Conduct of the Persian Gulf War, Final Report to Congress*, Washington, D.C.: GPO, April 1992.

———, Joint Publication 3-61, *Doctrine for Public Affairs in Joint Operations*, Washington, D.C.: GPO, May 14, 1997.

- , Joint Publication 3-09, *Doctrine for Joint Fire Support*, Washington, D.C.: GPO, 1998.
- , Joint Publication 3-13, *Joint Doctrine for Information Operations*, Washington, D.C.: GPO, October 9, 1998.
- , Joint Publication 1, *Joint Warfare of the Armed Forces*, Washington, D.C.: GPO, November 14, 2000.
- , *Quadrennial Defense Review Report*, Washington, D.C.: GPO, September 30, 2001.
- , “ASD PA Clarke Meeting with Bureau Chiefs,” news transcript, October 30, 2002.
- , News Transcript, Secretary of Defense Donald H. Rumsfeld, April 11, 2003.
- , Joint Publication 3-09.3, *Joint Tactics, Techniques, and Procedures for Coordinating Close Air Support (CAS)*, Washington, D.C.: GPO, September 2003.
- , Joint Publication 1-02, *Department of Defense Dictionary of Military and Associated Terms*, Washington, D.C.: GPO, April 12, 2001, as amended through June 9, 2004.
- , Joint Publication 3-40, *Joint Doctrine for Combating Weapons of Mass Destruction*, Washington, D.C.: GPO, July 8, 2004.
- , “Operation Iraqi Freedom Casualty Update,” as of March 11, 2005, 10:00 A.M., EST. For current updates:
<http://www.defenselink.mil/news/casualty.pdf>
- “U.S. Ground Forces in Iraq Weary of Repeated False Missile Alarms,” *Inside Missile Defense*, July 8, 2003.
- U.S. House of Representatives, *Statement of Dr. Stephen Biddle, Hearing of the House Armed Services Committee*, Washington, D.C.: GPO, October 21, 2003.
- , *Testimony of the Joint Chiefs of Staff Before the Committee on Armed Services, Regarding the Fiscal Year 2005 National Defense Budget Request for the Department of Defense*, Washington, D.C.: GPO, February 4, 2004.
- , *Testimony of Secretary of State Colin Powell, Hearing of the House International Relations Committee*, Washington, D.C.: GPO, March 7, 2001.
- “U.S. Increases Order for Combat-Tested Javelin,” Raytheon, News Release, October 5, 2005.
- U.S. Joint Forces Command, *Doctrinal Implications of the Standing Joint Force Headquarters (SJFHQ)*, Joint Warfighting Center Joint Doctrine Series, Pamphlet 3, June 16, 2003. As of June 2004:
http://www.dtic.mil/doctrine/jel/other_pubs/jwfcjam3.pdf
- U.S. Marine Corps, MCWP 3-25.3, *Marine Air Command and Control System Handbook*, Washington, D.C.: GPO, December 2, 1997.
- , MCWP 3-25.4, *Marine Tactical Air Command Center Handbook*, Washington, D.C.: GPO, September 21, 1998.
- “U.S. Missile Killed Pilot of Navy Fighter,” *International Herald Tribune*, April 15, 2003.
- U.S. Secretary of Defense, Office of the Assistant Secretary of Defense, Public Affairs, “Public Affairs Guidance (PAG) on Embedding Media During Possible Future Operations/Deployments in the U.S. Central Commands (CENTCOM) Area of Responsibility,” Cable to various military and government offices, February 10, 2003.

U.S. Senate, *Testimony of Secretary of State Colin Powell, Hearing of the Senate Foreign Relations Committee*, Washington, D.C.: GPO, February 5, 2002.

———, *Summary of Lessons Learned, Prepared Testimony by SECDEF Donald H. Rumsfeld and General Tommy R. Franks: Hearing before the Senate Armed Services Committee*, Washington, D.C.: GPO, July 9, 2003.

Wallace, Lieutenant General William Scott, Commander U.S. Army V Corps, Interview, PBS, *Frontline: Invasion of Iraq*, 2004.

Wang, Mark Y. D., *Accelerated Logistics: Streamlining the Army's Supply Chain*, Santa Monica, CA: RAND Corporation, MR-1140-A, 2000. As of October 2013:
http://www.rand.org/pubs/monograph_reports/MR1140.html

Weinraub, Bernard, "U.S. Finds Barrels That May Hold Chemical Weapons," *New York Times*, April 7, 2003.

Welsh, May Ying, "U.S. Trains Proxy to Quell Resistance," Aljazeera.net, June 6, 2004.

West, Bing, and Major General (USMC ret.) Ray L. Smith, *The March Up*, New York: Bantam Books, 2003.

"What Happened to Shock and Awe?," *Air Force Magazine*, November 2003.

"When Sanctions Don't Work," *The Economist*, April 8–14, 2000.

White House, "President Says Saddam Hussein Must Leave Iraq Within 48 Hours," Press Release, March 17, 2003. As of March 2008:
<http://www.whitehouse.gov/news/releases/2003/03/20030317-7.html>

———, "President Bush Addresses the Nation," Press Release, March 19, 2003. As of March 2008:
<http://www.whitehouse.gov/news/releases/2003/03/20030319-17.html>

White, Paul K., "Airpower and a Decade of Containment," *Joint Forces Quarterly*, Winter 2000–01, pp. 35–39.

White, Thomas, Secretary of the Army 2001–2003, in PBS, *Frontline*, 2004.

Williams, Lieutenant Colonel Willie, "FSB in Support of Offensive Operations: Personal Notes and After Action Report," 2003.

Wimmer, Robert, and Paul Ham, "Missile Base Seized by SAS," *Sunday Times*, March 30, 2003.

Wong, Leonard, Thomas A. Kolditz, Raymond A. Millen, and Terrence M. Potter, *Why They Fight: Combat Motivation in the Iraq War*, Carlisle, PA: Strategic Studies Institute, U.S. Army War College, July 2003.

Woodward, Bob, *Plan of Attack*, New York: Simon & Schuster, 2004.

Wright, Evan, *Generation Kill*, New York: G.P. Putnum's Sons, 2004.

Wright, Robin, "Iraqi Attack Ends CIA Attempt to Overthrow Saddam Hussein," *The Ottawa Citizen*, September 8, 1996, p. A6.

Wright, Robin, and Thomas E. Ricks, "Bremer Criticizes Troop Levels: Ex-Overseer of Iraq Says U.S. Effort Was Hampered Early On," *Washington Post*, October 5, 2004.

Zucchini, David, "Iraq's Swift Defeat Blamed on Leaders," *Los Angeles Times*, August 11, 2003, p. 1.

———, *Thunder Run: The Armored Strike to Capture Baghdad*, New York: Atlantic Monthly Press, 2004, pp. 1–66.

Soon after Operation IRAQI FREEDOM (OIF) began in March 2003, RAND Arroyo Center began compiling an authoritative account of the planning and execution of combat and stability operations in Iraq through 2004 in order to identify key issues that could affect Army plans, operational concepts, doctrine, and other Title 10 functions.

The resulting analysis, completed in January 2006, will interest those involved in organizing, training, and equipping military forces to plan for, deploy to, participate in, and support joint and multinational operations. Although focused primarily on Army forces and activities, the analysis also describes aspects of joint and multinational operations. RAND analysts collected the information in this report from many sources, including unit after-action reports, compilations of lessons learned, official databases, media reports, other contemporary records, and interviews with key participants in OIF.

This report presents a broad overview of the study findings based on unclassified source material. It traces the operation from its root causes in the first Gulf War through operations up to approximately the end of June 2004. It addresses strategy, planning, and organization for OIF; air and ground force operations; personnel, deployment, and logistics issues; coalition operations; the occupation that followed combat operations; and civil-military operations. Also, because the research conducted for this report covers events only through June 2004, events that occurred after that date would alter some of the conclusions and recommendations. In other cases, some recommendations might already have been implemented in whole or in part. Nevertheless, the report's recommendations are provided as they were originally formulated.



ARROYO CENTER

www.rand.org

\$49.95

